

## Product Information FTS-Series

## FOOD

# Calorimetric Flow Switch

## FTS-141, FTS-741



### Application

- Monitoring of flowing liquids in pipes
- The monitor can be used to measure liquids that are aqueous (water content  $\geq 50\%$ ), that do not contain oil and that have a medium temperature up to  $100\text{ }^{\circ}\text{C}$  ( $212\text{ }^{\circ}\text{F}$ )

### Application examples

- Flow monitoring in pipes from DN 25, e.g., as dry-run protection or for monitoring filters, agitators or cooling loops
- Also suitable for highly pure, aqueous media without particles or solids (e.g. ultra-filtered media, cola)

### Hygienic design/Process connection

- The Anderson-Negele weld-in sleeve EMS-132 or weld-in pipe EHG-.../ 1/2" creates a flow-optimized, hygienic and easy-to-clean installation configuration
- CIP cleaning to  $100\text{ }^{\circ}\text{C}$
- All materials in contact with the product are FDA-compliant
- Sensor made entirely of stainless steel
- Further connections to FTS-141 by using CLEANadapt adaptors: milk pipe, DRD, Varivent, APV Inline, BioControl
- Conformity to 3-A Standard with FTS-741

### Features

- Calorimetric measuring principle with pulsed heating
- Only one sensor tip, flow-optimized shape
- Insensitive toward temperature shocks, short response time
- Integrated sensor protection: automatic switch-off at  $T > 100\text{ }^{\circ}\text{C}$  (switch on hysteresis at  $T < 95\text{ }^{\circ}\text{C}$ )
- Freely adjustable switch output  $15\text{...}200/300\text{ cm/s} = 7\text{...}100\%$
- Indicator (within head), LED for switching state

### Options/Accessories

- Preassembled cable for M12 plug

### Authorizations



### Flow switch FTS-741



### Flow switch FTS-141

**CSI**

 417.831.1411  
 csidesigns.com

**Functional principle**

The functional principle of the FTS calorimetric flow monitor is based on a temperature sensor (3) mounted on the sensor tip (1) that is periodically heated by a heating element (2). When the medium is stationary, a constant temperature difference  $\Delta T$  arises between the heated and unheated state. When the medium flows, heat energy is withdrawn from the heated temperature sensor and the temperature difference changes in relation to the flow rate.

In contrast to designs with two separate temperature sensors, of which one is constantly being heated, the measuring principle of the FTS with only one sensor and periodic heating has a lower response time due to the optimized heat transfer and lower heat capacity.

The response time is also significantly influenced by the heat conductivity of the medium. In general, the lower the heat conductivity of the medium, the higher the medium flow rate must be for measurement to be possible.

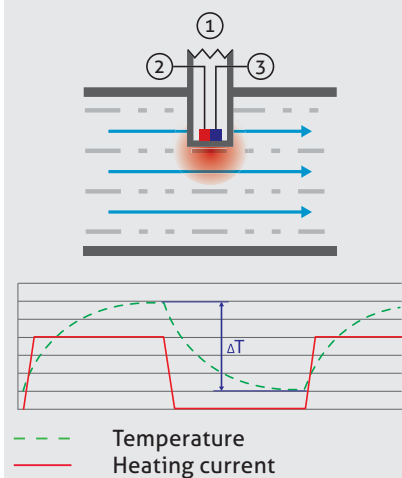
**Schematic drawing**

Specification		
Process connection	thread	Hygienic G1/2" CLEANadapt tightening torque max. 20 Nm sizes: 1½", 2"
	Tri-Clamp	
Materials	sensor head/ metal cap	1.4308 (CF-8)
	process connection (wetted parts)	1.4404 (316L)
	cap (plastic)	Polycarbonate
Temperature ranges	ambient	-20...70 °C (-4...158 °F)
	process / CIP	0...100 °C (32...212 °F)
	SIP	140 °C (284 °F) with no function / max. 60 min.
Operating pressure		max. 10 bar (CLEANadapt) max. 60 bar (Tri-Clamp)
Protection class		IP 69 K
Measuring range	FTS-141	10...200 cm/s (6.5 ft/s; 78.7 in/s)
	FTS-741	10...300 cm/s (9.8 ft/s; 118.1 in/s)
Response time reaction time	in case of temperature leap	5 s max. 10 s at 40 K
Accuracy*	in nominal width range	10 % of full scale DN25...DN100
Switch point	freely adjustable	
	FTS-141	7...100 % / 15...200 cm/s (6.5 ft/s)
	FTS-741 hysteresis	7...100 % / 15...300 cm/s (9.8 ft/s) 10 %
Indicator	7 segment red LED	in % of measuring range output switching state
Electrical connection	cable connector	M12 connector 1.4301
	supply voltage	16...32 V DC
	current consumption	60 mA (24 V DC)
Output		PNP, max. 200 mA short circuit proof and protected against reverse polarity
Weight	FTS-141	410 g
	FTS-741 with Tri-Clamp 1½"	440 g
	FTS-741 with Tri-Clamp 2"	520 g

\*) Reference conditions in case of laminar flow profiles: calibration medium is water at ambient temperature.

**Measurable media**

The following media can be measured: aqueous liquids (water content  $\geq 50\%$ ) and liquids that do not contain oil, such as water, milk, beer, fruit juice, CIP media, etc. Gases, oils and media containing oil cannot be measured with the FTS.

**Notice**

Flow monitor FTS has an integrated self-protection mechanism that prevents damage: At medium temperatures over  $100\text{ }^{\circ}\text{C}$ , the sensor is automatically switched off with a hysteresis of  $5\text{ }^{\circ}\text{C}$ . Three lines appear on the indicator.

**Intended use**

- Not suitable for applications in potentially explosive areas.
- Not suitable for applications in safety-relevant system parts (SIL).

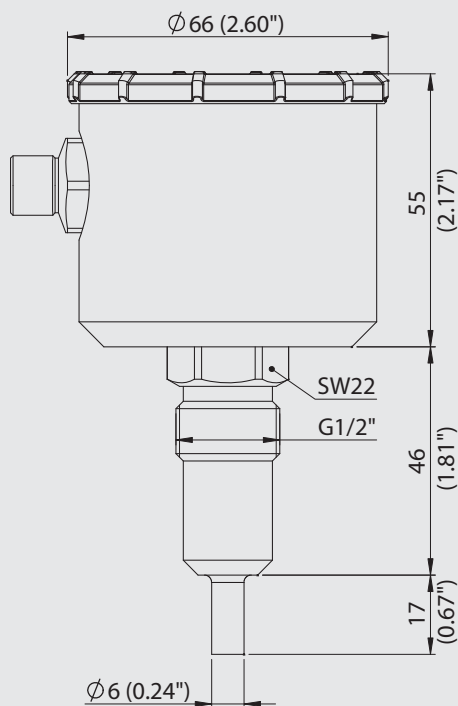
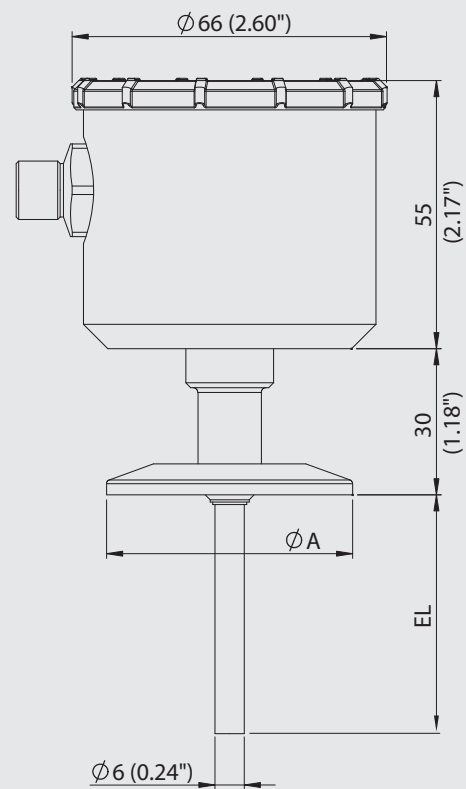
**Dimensional drawing FTS-141****Dimensional drawing FTS-741****Dimension Table on FTS-741**

Order code	Clamp size A [mm / inch]	Immersion length EL [mm / Inch]	Suitable for pipe diameter	Pipe style
FTS-741/C10...	50.5 / 1½"	49 / 1.93	DN 25...40 ISO 14...25  1½"	DIN 11866 series A DIN 11866 series B / ISO 1127 DIN 11866 series C / ASME-BPE
FTS-741/C20...	64 / 2"	59 / 2.32	DN 50 2"	DIN 11866 series A DIN 11866 series C / ASME-BPE

**Electrical connection FTS**

- 1: + power supply 16...32 V DC
- 2: Not assigned
- 3: 0 V supply voltage (GND)
- 4: Switch output active

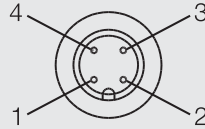



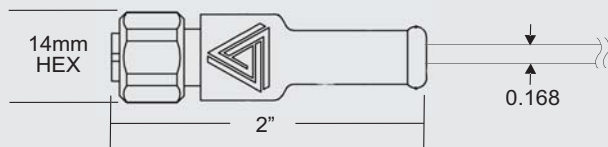
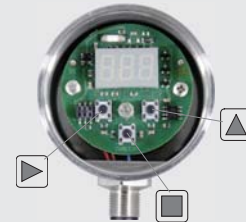

**5 Conductor Wiring**

Pin out	Wire color	Female end view
PIN 1	Red	
PIN 2	Black	
PIN 3	Green	
PIN 4	Brown	
PIN 5	White	
KEY	Shield	







**Molded End Blue****Inside view and key assignment****Operation FTS****1. Starting up**

- Install the FTS and make the electrical connections
- Initialization phase: Indicator displays "888" (flashing) for approx. 20 s
- Then the flow rate is displayed as a % of the measuring range
- The switch output is adjusted according to the set value





**2. Menu guidance**

- Open the operating mode: Key combination 2x , 2x , 2x  press within 10 s
- Main menu level "SP" (switch point setting) appears on the indicator
- Navigation in the menu field:
  -  to the right,
  -  upward, changing the values
  -  to the left, accepting the new parameter settings, leaving the operating mode

**3. Setting the switch point**

- Under "SP" in the main menu level, select the editing mode with 
- Move to the first digit with ; the digit flashes
- Enter the desired value with 
- Edit the next digit with ; the digit flashes, etc.
- Accept the switch point with 2x 
- Leave the menu mode with 1x 

**4. Setting the switch output**

- Default setting: normally open contact
- If the normally closed function is to be set, proceed as follows:
  - In the main menu level, select "O-C" with ,
  - Open the editing mode with ; the indicator shows "n.o." (normally open contact, default setting)
  - 1x , the indicator shows "n.c." (normally closed contact)
  - 2x : accept the setting
  - : leave the menu mode



FTS-741 Setpoint by Line Size and Velocity										
Line Size	Velocity ft/sec (m/sec)									
	1.0 (0.3)	2.0 (0.6)	3.0 (0.9)	4.0 (1.2)	5.0 (1.5)	6.0 (1.9)	7.0 (2.1)	8.0 (2.4)	9.0 (2.7)	10.0 (3.0)
Line Size	Flow rate gpm (lpm)									
1"	1.9 (7.2)	3.8 (14.4)	5.6 (21)	7.5 (28)	9.4 (35)	11 (43)	13 (50)	15 (57)	17 (64)	19 (72)
1.5"	4.6 (18)	9.2 (36)	14 (52)	19 (70)	23 (87)	28 (105)	32 (123)	37 (140)	42 (158)	46 (180)
2"	8.6 (33)	17 (66)	26 (98)	34 (130)	43 (163)	52 (195)	60 (228)	69 (261)	77 (293)	86 (330)
2.5"	14 (52)	28 (104)	42 (159)	56 (212)	70 (265)	84 (318)	97 (366)	110 (418)	124 (470)	140 (520)
3"	20 (76)	40 (152)	60 (228)	80 (303)	101 (383)	121 (459)	142 (536)	162 (613)	182 (689)	200 (760)
4"	37 (140)	74 (280)	74 (420)	147 (557)	184 (696)	221 (835)	257 (974)	294 (1113)	331 (1252)	370 (1400)
FTS-741 Display / Setpoint	10	20	30	40	50	60	70	80	90	100

FTS-141 Setpoint by Line Size and Velocity						
Line Size	Velocity ft/sec (m/sec)					
	1.0 (0.3)	2.0 (0.6)	3.0 (0.9)	4.0 (1.2)	5.0 (1.5)	6.0 (1.9)
Line Size	Flow rate gpm (lpm)					
1"	1.9 (7.2)	3.8 (14.4)	5.6 (21)	7.5 (28)	9.4 (35)	11 (43)
1.5"	4.6 (18)	9.2 (36)	14 (52)	19 (70)	23 (87)	28 (105)
2"	8.6 (33)	17 (66)	26 (98)	34 (130)	43 (163)	52 (195)
2.5"	14 (52)	28 (104)	42 (159)	56 (212)	70 (265)	84 (318)
3"	20 (76)	40 (152)	60 (228)	80 (303)	101 (383)	121 (459)
4"	37 (140)	74 (280)	74 (420)	147 (557)	184 (696)	221 (835)
FTS-141 Display / Setpoint	15	30	45	60	75	95



**CSI**

417.831.1411  
csidesigns.com

**Mechanical connection/Installation**



- Ensure that the pipe in which the sensor is installed is completely filled with liquid. Installation in a rising pipe is recommended (in which the direction of flow is upward)
- Note the inlet and outlet dimensions (see drawing DN = pipe cross section)

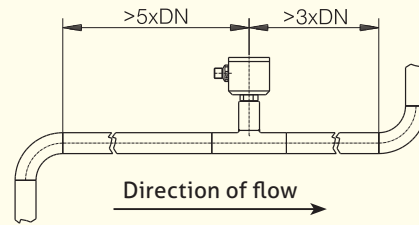

**Conditions for a measuring point according to 3-A Sanitary Standard 74-06**



- Only the FTS-741 is suitable for applications requiring 3-A compliant equipment.
- The sensors are designed for CIP-/ SIP-cleaning. Maximum 140 °C / 60 min.
- Only with 3-A conforming Tri-Clamp connection.
- Mounting position must allow for self draining to be in accordance to current 3-A Sanitary Standard.

**Pipe T dimensions for FTS-741**

Tri-Clamp size [inch]	Pipe [inch]	Pipe [mm]	T-Short Extract	
			B [mm]	L [mm]
1½	1½	38.1 x 1.65	34.9	15.9
2	2	50.8 x 1.65	41.3	15.9
2	2½	63.5 x 1.65	47.6	15.9

**Pipe T**

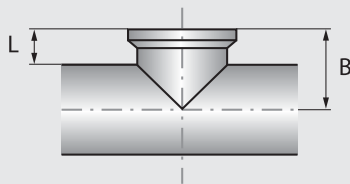

**Note**



The Flow Switch FTS-741 is specially designed to work with pipe Ts that have a short extract.

**Adapter for FTS-141**

G1/2"			
Diameter		EHG	Varivent
DN25	1"	EHG-DIN2-25/1/2"	AMV-132/25
DN40	1½"	EHG-DIN2-40/1/2"	AMV-132/40
DN50	2"	EHG-DIN2-50/1/2"	AMV-132/50
DN65	2½"	EHG-DIN2-65/1/2"	AMV-132/65

**Transport/storage**

- Do not store outside
- Store in an area that is dry and dust-free
- Do not expose to corrosive media
- Protect against solar radiation
- Avoid mechanical shock and vibration
- Storage temperature 0...40 °C
- Relative humidity max. 80 %

**Notice on conformity**

## Applicable directives:

- Electromagnetic Compatibility Directive 2004/108/EC
- The CE label confirms compliance of this product with the applicable EC directives.
- You have to guarantee the compliance of all guidelines applicable for the entire equipment.

**Disposal**

- This instrument is not subject to the WEEE directive 2002/96/EC and the respective national laws.
- Give the instrument directly to a specialized recycling company and do not use the municipal collecting points.

**Returning to Anderson-Negele**

- Sensors and process connection must be clean and must not be contaminated with hazardous media and/or heat-conductive paste. Note the cleaning information!
- To avoid damage of the equipment, use suitable transport packaging only.

**Standards and guidelines**

- Compliance with the applicable regulations and directives is mandatory.

**Cleaning/maintenance**

- When using a pressure washer, do not point the nozzle directly at the electrical connections.

**CSI**417.831.1411  
csidesigns.com

**Order code CLEANadapt G1/2" process connection**

**FTS-141** Calorimetric Flow Sensor with switch output, CLEANadapt G1/2" process connection

**Cap**

**X** (Plastic without window)  
**P** (Plastic with control window)  
**M** (Metal without control window)  
**W** (Metal with control window)

FTS-141 - X

**Order code direct process connection in one piece design**

**FTS-741** Calorimetric Flow Sensor with switch output, direct process connection

**Process connection**

**C10** (Tri-Clamp 1½")

**C20** (Tri-Clamp 2")

**Cap**

**X** (Plastic without window)  
**P** (Plastic with control window)  
**M** (Metal without control window)  
**W** (Metal with control window)

**Surface finish**

**XX** (0.8 microns / 0.8 µm)

FTS-741 - C20 X XX

**Accessories**

**Cert - 2.2 - FTS** factory certificate 2.2 acc. to EN10204  
 (product-contacting surface only)

**5 conductor molded cord set**

**42117H0025** 25' length

**42117H0050** 50' length

**42117H0100** 100' length



**CSI**

417.831.1411  
 csidesigns.com