

Product Information TSMA
FOOD

Temperature Sensor Mini

Application/Specified usage

- Temperature sensor in mini housing for food applications
- Aseptic temperature process connections without product contact for inline, precise and fast measurement.

Application examples

- Monitoring of CIP-/SIP-process
- Safe temperature measurement in hot steam and pressurized pipes
- Measurement in vessels with agitators with front flush version
- Temperature monitoring in vessels or pipes

Hygienic design/Process connection

- All wetted materials are FDA-conform
- Versions compliant to 3-A Standard 74- available
- Sensor completely made of stainless steel
- Complete overview of process connections: see order code

Features/Advantages

- High accuracy and high ambient temperature resistance
- Customer offset and slope adjustment
- Flex hybrid mode with digital IO-Link and analog 4...20 mA
- Process temperature range -45...176 °C (-50...350 °F)

Options/Accessories

- Integrated transmitter
- Programmable transmitters TTM.H and TTM.I using IO-Link
- Pre-assembled connecting cable for M12 plug
- IO-Link Master (IOM-1)
- Add-On Instructions are available at www.anderson-negele.com/aoi

Communication
 **IO-Link**
 **4...20 mA**
Certifications

Temperature sensor TSM with Tri-Clamp

Temperature sensor TSM with NPT

Configurable design

Temperature sensor		
Process connection	Tri-Clamp NPT NPT Spring Loaded Thermowell	1/2", 3/4", 1½", 2", 2½" (DIN 32676)
Dimensions	insertion length rod diameter	1½...43½" 5/32", 1/4", 3/8", 3/4", 41247 Well
Materials	connecting head, spacer wetted parts	stainless steel 1.4301 (AISI 304) stainless steel 1.4404 (AISI 316L)
Surface quality		R _a ≤ 25 µin
Operating pressure		145 psi (10 bar) max
Process temperature	standard range	-45...176 °C (-50...350 °F)
Resistance Temperature Detector (RTD)	accuracy class	Class A: ±(0.15 + 0.002 × t) °C
Electrical connection	plug connection	M12 plug 1.4301 (AISI 304)
Protection class		IP 69 K (with electrical connection M12 plug)

Transmitter TTM.I, TTM.H		
Temperature ranges	ambient storage	-40...85 °C / -40...185 °F -55...90 °C / -67...194 °F
Measuring ranges		standard °C: -10...40, 0...50 / 100 / 150 / 200 °C standard °F: 0...100, 0...150, 0...200, 30...230, 0...250 °F custom ranges programable
Accuracy	input repeatability	≤ 0.1 K (at ambient ≤ 85 °C / 185 °F) ≤ 0.05 K
Temperature drift	typical maximum	5 mK/K (at 25 °C / 77 °F) 10 mK/K (at 25 °C / 77 °F)
Adjustments	damping offset slope	0...120 s ≤ ±10 K ≤ ±25 %
Digital output	IO-Link digital resolution master cycle time power supply	IO-Link 0.01 K ≤ 51.2 ms 18...30 V DC according to IO-Link
Analog output (TTM.H only)	signal accuracy temperature drift typical temperature drift max effect of supply voltage variations maximum load resistance power supply	4...20 mA, 2 wire ≤ 0.05 % of upper range limit 0.0005 %/K (at 25 °C / 77 °F) 0.003 %/K (at 25 °C / 77 °F) < 0.001 %/V (at 24 V DC) R ≤ (V DC - 12 V) : 0.024 A (at 25 °C / 77 °F), see diagram 12...30 V DC

Accuracy classes of temperature sensors | Tolerances for Pt100 acc. to DIN EN 60751

Pt100	Class A
0 °C / 100 Ω	±0.15 K / ±0.06 Ω
100 °C / 138.5 Ω	±0.35 K / ±0.13 Ω

Electrical connection without transmitter

1x RTD with M12 plug

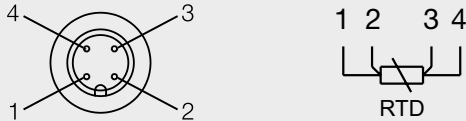

Electrical connection with transmitter

1x RTD with M12 plug for analog operation

- 1: + power supply
- 2: - power supply 4...20 mA
- 3: not connected
- 4: not connected

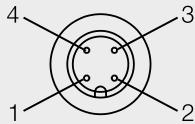

1x RTD with M12 plug for IO-Link operation

- 1: + power supply 24 V DC
- 2: not connected
- 3: - power supply
- 4: IO-Link

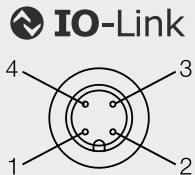

Load resistance diagram at ambient temperature 85 °C

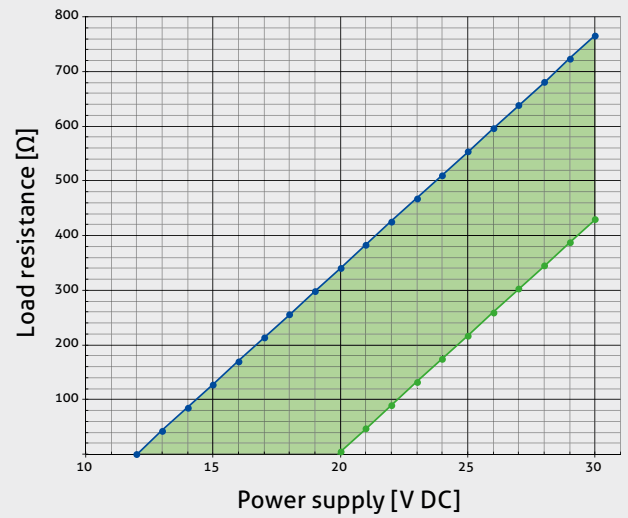

● R_{max}

● R_{min} (85 °C / 185 °F ambient temperature)

Configurable design

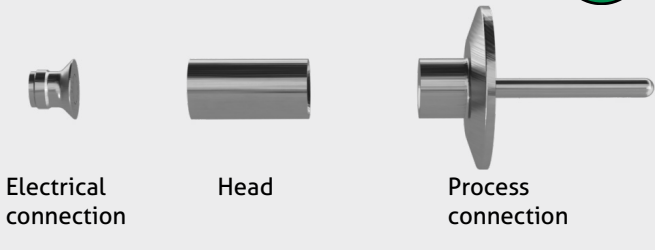

Electrical connection | Head



M12 plug 4 pins without transmitter

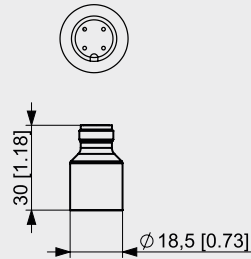

M12 plug 4 pins with transmitter

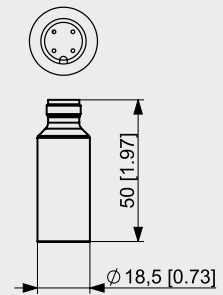

Process connection



1/2" and 3/4" Tri-Clamp®

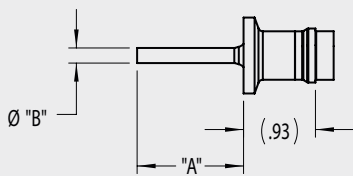

1½" and 2" Tri-Clamp®

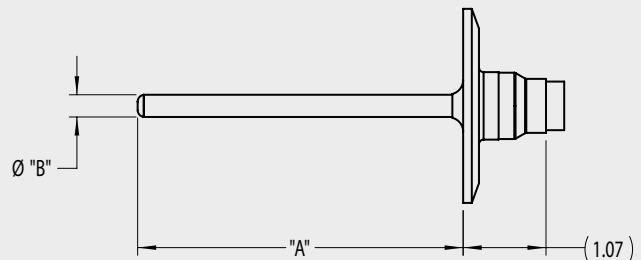

Dimensions table 1/2" and 3/4" Tri-Clamp®

Code	Description	Typical Length "A"	Dim. Custom Length "A"	Dim. "B"
001	1/2" Tri-Clamp®	1½"	1½" Min. - 6" Max	5/32"
002	3/4" Tri-Clamp®	1¾" and 2¾"	1½" Min. - 6" Max.	5/32"

Dimensions table 1½" and 2" Tri-Clamp®

Code	Description	Typical Length "A"	Dim. Custom Length "A"	Dim. "B"
004	1½" Tri-Clamp®	2¾"	1¾" Min. - 4¾" Max.	1/4"
		3¼"	2¾" Min. - 4¾" Max.	3/4"
005	2" Tri-Clamp®	3½"	1¾" Min. - 4¾" Max.	1/4"
		3¾"	2¾" Min. - 4¾" Max.	3/4"

1/2" NPT Spring Loaded

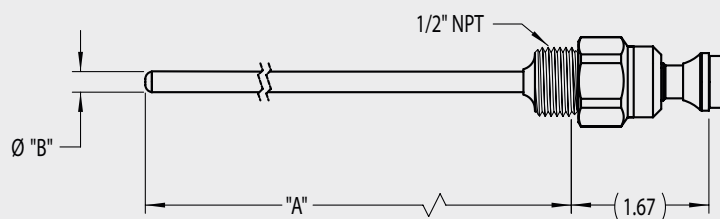

Dimensions table 1/2" NPT Spring Loaded

Code	Description	Typical Length "A"	Dim. Custom Length "A"	Dim. "B"
174	1/2" NPT - Spring Loaded	6" and 9"	2¾" Min. - 4¾" Max.	1/4"

E1 Plain Probe and E3 Plain Probe with Adjustable Union

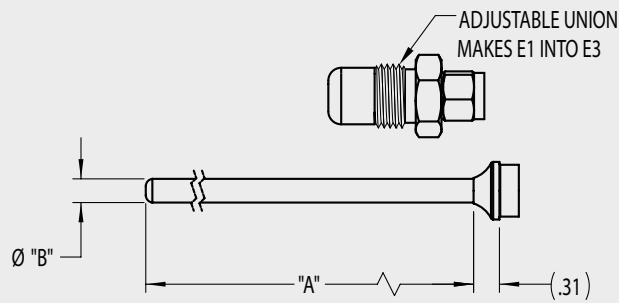

Dimensions table E1 Plain Probe and E3 Plain Probe with Adjustable Union

Code	Description	Typical Length "A"	Dim. Custom Length "A"	Dim. "B"
074	E1 - Plain probe	12"	4" Min. - 43½" Max.	1/4"
075	E1 - Plain probe	18"	4" Min. - 43½" Max.	3/8"
079	E3 - Probe with adjustable union	12"	4" Min. - 43½" Max.	1/4"
080	E3 - Probe with adjustable union	18"	4" Min. - 43½" Max.	3/8"

Thermowell 41247

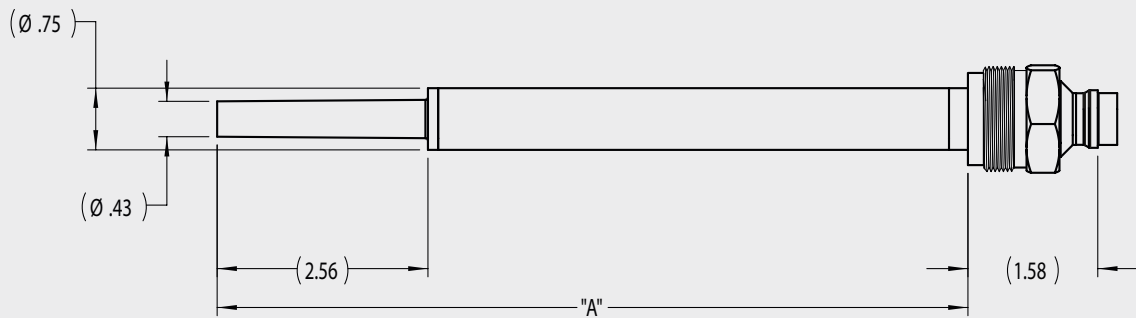

Dimensions table - Thermowell 41247

Code	Description	Typical Length "A"	Dim. Custom Length "A"	Dim. "B"
062	Thermowell 41247	9½"	N/A	NA

1/2" NPT

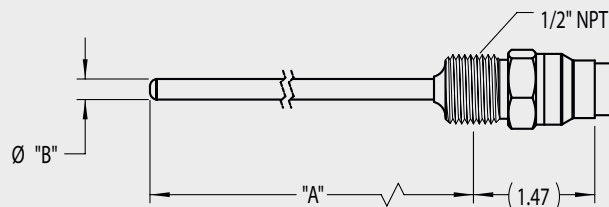

Dimensions table 1/2" NPT

Code	Description	Typical Length "A"	Dim. Custom Length "A"	Dim. "B"
084	1/2" NPT	6" and 9"	2" Min. - 43½" Max.	1/4"

Transport/Storage

- Do not store outside
- Store in an area that is dry and dust-free
- Do not expose to corrosive media
- Protect against solar radiation
- Avoid mechanical shock and vibration
- Storage temperature -55...+90 °C / -67...194 °F
- Relative humidity max. 98 %

Cleaning/Maintenance

- When using a pressure washer, do not point the nozzle directly at the electrical connections.

Reshipment

- Sensors shall be clean and free of media or heat-conductive paste and must not be contaminated with dangerous media!
- Use suitable transport packaging only to avoid damage of the equipment!

Note on 3-A Sanitary Standard 74-

Information on installation according to 3-A standard is available on our website:
www.anderson-negele.com/3A74.pdf

Click on the PDF icon to download the document.

Caution

When mounting units, never adjust the orientation by turning the housing. Install the sensor into the process using the appropriate sanitary clamp and gasket, or by threading into a mating thermowell. Orient the conduit connection for ease of connection to field wiring before final tightening.

Warning

Remove power from the unit before installing, removing, or making adjustments

Conventional usage

- Not suitable for applications in explosive areas.
- Not suitable for applications in safety-relevant system parts (SIL).

Standards and guidelines

- Compliance with the applicable regulations and directives is mandatory.

Note on CE

- Applicable directives:
Electromagnetic Compatibility Directive 2014/30/EU
- Compliance with the applicable EU directives is identified by the CE label on the product.
- The operating company is responsible for complying with the guidelines applicable to the entire installation.

Disposal

- Electrical devices should not be disposed of with household trash. They must be recycled in accordance with national laws and regulations.
- Take the device directly to a specialized recycling company and do not use municipal collection points.

Order code

TSMA Temperatur Sensor Mini for Food Applications, material wetted parts 1.4404 (AISI 316L)

Process connection (A: 3-A compliant)

001	Tri-Clamp 1/2"	074	E1 Style - 1/4" Dia. (A)
002	Tri-Clamp 3/4" (A)	075	E1 Style - 3/8" Dia. (A)
004	Tri-Clamp 1½" (A)	079	E3 Style - 1/4" Dia. (w/ adj. union)
005	Tri-Clamp 2" (A)	080	E3 Style - 3/8" Dia. (w/ adj. union)
062	Thermo Well 41247 (A)	084	1/2" NPT (A)
		174	1/2" NPT Spring Loaded (A)

X Fixed character

RTD type

0 1x Pt100 A, 3-wire

Insertion length [inches]

01...43 In steps of 1 inch

Insertion length [sixteenth]

00	0"	08	1/2"
01	1/16"	09	9/16"
02	1/8"	10	5/8"
03	3/16"	11	11/16"
04	1/4"	12	3/4"
05	5/16"	13	13/16"
06	3/8"	14	7/8"
07	7/16"	15	15/16"

Rod diameter (process connection specific)

20	5/32" (001, 002)
21	1/4" (004, 005, 074, 079, 084, 174)
22	3/8" (075, 080)
23	3/4" (004, 005)
24	41247 Well (062)

XX Fixed character

Surface finish

1 $R_a \leq 25 \mu\text{in}$

Transmitter

0	Without transmitter
I	TTM.I (IO-Link only)
H	TTM.H (hybrid: analog and IO-Link)

Measurement range

000	Without transmitter	04C	-10...40 °C
00C	Unit °C	05C	0...50 °C
	(only for TTM.I)	10C	0...100 °C
00F	Unit °F	15C	0...150 °C
	(only for TTM.I)	20C	0...200 °C
00K	Unit K	25C	0...250 °C
	(only for TTM.I)	10F	0...100 °F
M00	TTM custom configuration	15F	0...150 °F
		20F	0...200 °F
		23F	30...230 °F
		25F	0...250 °F
		30F	0...300 °F

Electrical connection with transmitter

4 M12 plug (4 pin, $\leq 90 \text{ °C} / 197 \text{ °F}$)

XX Fixed character

TSMA / 001 / X / 0 / 0100 / 20 / XX / 1 / 0 / 000 / 4 / XX