

Instruction Manual

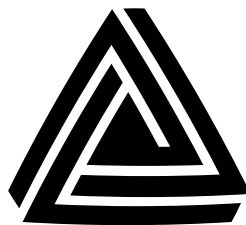

Anderson Instrument Co. Inc.
156 Auriesville Road
Fultonville, NY 12072
1-800-833-0081
www.anderson-negele.com

ANDERSON-NEGELE

Instrument Model Number _____

Instrument Serial Number _____

SL/SX LEVEL TRANSMITTER

Safety Warnings



Warning! This unit accepts DC voltage only, connection to AC voltage can cause failure of the sensor and/or risk of electrocution



Warning! Do not remove this sensor from the process while it is operating. Removal while the process is operating can contaminate the process and could cause human injury.



Warning! Do not subject this sensor to pressure that exceeds the specified upper range limit. Over-pressure may cause premature failure, incorrect output signal, or possible human injury.



Warning! Before removing for service or calibration, ensure that tank is empty.



Warning! This unit accepts DC voltage only, connection to AC voltage can cause failure of the sensor and/or risk of electrocution

Section 1 - Field Wireable Connector Assembly

CABLE REQUIREMENTS

1. Insert cable through Pressing Screw, Compression Ring, Seal Grommet, and Sleeve as shown below.
2. Strip back 1-1/4" of outer sheathing, cut off any excess wires, shield and ground. Strip off 1/4" insulation from remaining two wires. It is not necessary or recommended to tin the wires.

3. Orient Connector end so that center pin connecting screw is horizontal facing right (see detail).

- 2 conductor, stranded, 18-24 AWG, shielded with ground.
 - 4-8mm (0.16-0.31") Cable Sheath
4. Wire LOOP+ (red) wire to top-right terminal, and LOOP- (black) wire to top-left terminal. No connection is made to the center and bottom terminals.

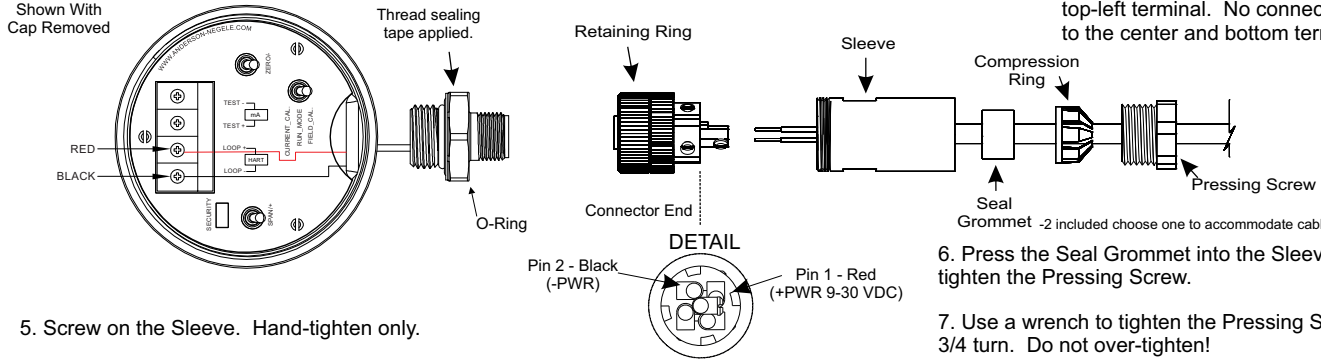

5. Screw on the Sleeve. Hand-tighten only.

6. Press the Seal Grommet into the Sleeve and hand-tighten the Pressing Screw.

7. Use a wrench to tighten the Pressing Screw another 3/4 turn. Do not over-tighten!

To install connector, simply line up key, press into receptacle, and hand-tighten the retaining ring.

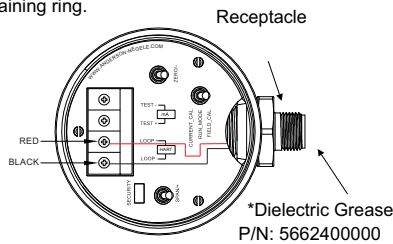

Molded Cord Set - Shielded

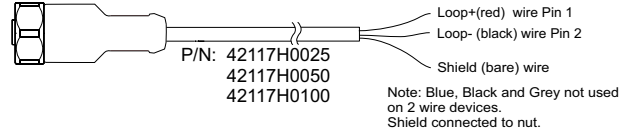

Molded Cord Set

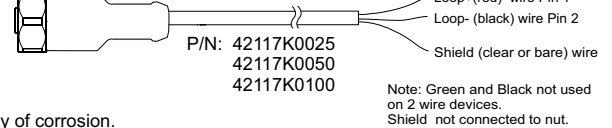

*Receptacle pins should be coated with USDA approved dielectric grease to minimize possibility of corrosion.

Section 2 - Proper Transmitter Wiring & Testing

- For units equipped with HART, HHT must be connected to loop. For detailed instructions see manual section 3.7. A Digital MultiMeter may be connected across Test+ and Test- to verify operation by observing the following readings:
1. 4 mA while vessel is empty. Value increases as level increases.
 2. 20 mA with MODE Switch in FIELD CAL position.
 3. Between 7.2 and 20 mA with MODE Switch in CUR CAL position. (The exact CUR CAL value indicates the calibration - see Sect. 4)

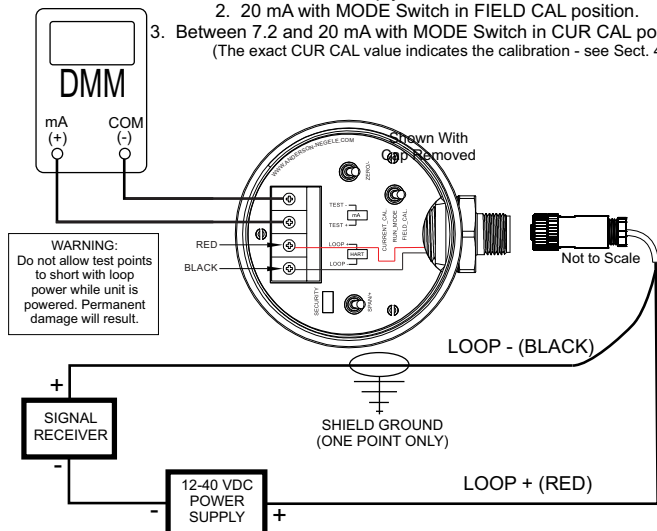

Section 3 - Sensor Rezero Procedure

Receiver and Meter Connections omitted for clarity. Meter may be used to verify 4.00 mA output, but is not required to perform Sensor Rezero Procedure.

PROCEDURE MUST BE PERFORMED WHEN:

- Sensor is initially installed.
- Whenever sensor is reinstalled in vessel.
- About 1-2 months after initial installation.
- Annually, as part of a PM program.

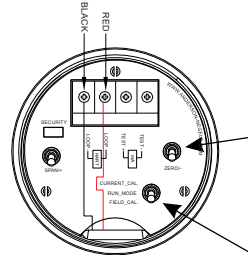

1. Sensor MUST be installed and properly wired.
2. Vessel MUST be empty and temperature stable.
3. MODE Switch must be set to RUN.
4. Press and Hold the ZERO Switch for 5-8 sec. The sensor output will jump to 4.00 mA
5. Rezero Procedure complete. Replace cap.

SWITCH FUNCTIONS:

RUN: Normal Operating Mode, Rezero or Span with Pressure in RUN Mode

CURRENT CAL: Read CURRENT CAL Value with DMM Across Testpoints

FIELD CAL: Program New CURRENT CAL Value with DMM Across Testpoints

SPAN: Increase (+) Key while in FIELD CAL Mode, or Set Span with Pressure in Run Mode

ZERO: Decrease (-) Key while in FIELD CAL Mode, or Set Zero with Vessel Empty in Run Mode

Section 4 - Calibration Verification

Anderson typically calibrates Level Transmitters specifically for the application for which it was intended. The factory calibrated value will be indicated by the last 5 digits of the sensor Model number to the nearest 1/10"WC (inches Water Column). All zeros indicate that the unit was not calibrated at the factory and that the unit would be calibrated in the field. In the sample Model number: SL5089100001234, the calibration is indicated by the "01234" as 20 mA @ 123.4"WC. Therefore, the sensor will output its full scale value of 20 mA at 123.4"WC pressure. The specific calibration, or SPAN value of the level transmitter is programmable, and can be modified in the field. Since the SPAN is easily changed, we must verify that a sensor is properly calibrated to insure overall system accuracy. This is easily accomplished utilizing a Digital MultiMeter.

1. Determine the SPAN value as dictated by the Model # or the application.
2. Based on the first 3 digits of the sensor Model # determine the MAX CAL value.
 SL1/SL5/SX5/LD2/LA2 MAX CAL = 145 SL3/SL7 or SX7 MAX CAL = 835
 SL2/SL6 or SX6 MAX CAL = 420 SL4/SL8 or SX8 MAX CAL = 1390
3. Determine the CUR CAL value in mA by performing the mA translation calculation:
 $CUR\ CAL = ((SPAN / MAX\ CAL) \times 16) + 4\ mA$
 Example: $((123.4 / 145) \times 16) + 4\ mA = 17.62\ mA$
 If provided as part of a system, the CUR CAL value may also be documented on a SYSTEM DATA SHEET.
4. Connect DMM as shown in Sect. 2. Move the MODE Switch to CURRENT CAL.
5. The displayed mA value should match the calculated CUR CAL value. If it does not, the sensor is not correctly calibrated and should be re-Spanned. Please refer to Section 3.5 of the SL/SX manual for this procedure.
 The manual is available on the web at: www.anderson-negele.com

Section 5 - Troubleshooting Guide

AS TROUBLESHOOTING MAY CAUSE CHANGES IN SENSOR OUTPUT, SECURE ALL AUTOMATED CONTROLS PRIOR TO BEGINNING PROCEDURES

Most troubleshooting will require that you connect a Digital MultiMeter across the testpoints as indicated in Section 2. If you find that you need to contact the factory for assistance, please first record your findings in the spaces provided

- | | |
|--|---|
| 1. Tank Name _____
: _____
2. Sensor Model #: _____
3. Sensor Serial #: _____
4. Receiver/Display: _____ | 5. DC Voltage across LOOP+ & LOOP-: _____
6. As found mA output when vessel empty: _____
7. mA output after Rezero performed: _____
8. mA output in CUR CAL Mode: _____
9. mA output in FIELD CAL Mode: _____ |
|--|---|

SYMPTOM:

ACTION:

1. NO OUTPUT CURRENT (ZERO MA) IN ANY MODE:

Loop may be broken - Measure voltage across LOOP+ and LOOP- terminals.
 If not between 12-40 VDC, check connector and external loop wiring.
 Check if mA fuse in DMM is blown. This frequently occurs during testing.

2. CURRENT OUTPUT LESS THAN 4 MA AND DOES NOT INCREASE WITH LEVEL, OR IF MODE SWITCH SET TO

Connect milliammeter across LOOP+ terminal and TEST- testpoint.
 If loop now works, sensor circuitry has been damaged. Contact factory.

3. OUTPUT STUCK BETWEEN 4 AND 20 MA

Verify that MODE switch is in RUN mode.
 Empty vessel and perform Sensor Rezero Procedure as described in

4. PERFORMING SENSOR REZERO PROCEDURE DOES NOT RETURN OUTPUT TO 3.96-4.04 MA

Verify that CUR CAL output is between 7.2 and 20 mA.
 If current is less than 4 mA, follow instructions for Symptom #2.
 If current is greater than 4 mA, sensor is damaged. Contact factory.

5. SENSOR OUTPUT IS NOT STABLE.
 6. OUTPUT DRIFTS OVER TIME.

Verify that CUR CAL value is between 7.2 and 20 mA
 Check for signs of moisture or water in housing. Contact factory.
 Rezero only when vessel is empty and temperature stable. Recommend after process and prior to CIP

7. SENSOR MA OUTPUT NOT AS EXPECTED FOR SPECIFIC LEVEL.

Perform Sensor Rezero procedure when vessel is empty.
 Verify proper CURRENT CAL output according to Section 4.

9. SENSOR OUTPUT IS GREATER THAN 20 MA.

Sensor may have been zeroed with product in the vessel.
 Perform Sensor Rezero Procedure as described in Section 3.
 Sensor may be over-ranged. Verify CUR CAL value, and that it is appropriate for the application. Contact factory for assistance.

10. SENSOR OUTPUT DOES NOT INCREASE WITH LEVEL, BUT DOES INCREASE TO 20 MA IF MODE SWITCH SET TO

Sensor may have been dropped or over-ranged and permanently damaged.
 Contact factory for assistance.

Table of Contents

Section 1 - General	Page
1.1 Description SL/SX	8
1.2 Description - SX	8
1.3 Intended Use	8
1.4 Specifications	9
Section 2 - Installation	
2.1 Tank Shell Installation	12
2.2 Installation of Level Transmitter	12
2.3 Atmospheric Venting	13
2.4 Electrical Wiring	14
2.5 Transmitter Electronic "Zero" Calibration	16
Section 3 - Calibration	
3.1 Field or "Wet" Calibration	17
3.2 Sensor Factory Calibration Overview	20
3.3 Calibration Verification - Utilizing on Board Setup	21
3.4 Calibration Verification - Utilizing External Pressure Source	22
3.5 Calibration - Utilizing on Board Setup	24
3.6 Calibration - Utilizing External Pressure Source	26
3.7 Calibration - Utilizing HART Communicator	28
Section 4 - Maintenance and Troubleshooting	
4.1 General	30
4.2 Calibration Checks	30
4.3 Vent System	30
4.4 Gaskets	30
4.5 Troubleshooting	31
Appendix A - Spare Parts and Accessories	32
Appendix B - Intrinsically Safe Requirements for SX Transmitter	33
Appendix C - Warranty and Return	35
FIGURES	
Figure 1-1 Shell and Sensor Dimensions	10,11
Figure 2-1 Tapered Gasket Installation	13
Figure 2-2 Sensor Venting	13
Figure 2-3 Required Supply Voltages	14
Figure 2-4 Transmitter Loop Diagram	15
Figure 2-5 Zero Calibration Procedure	16
Figure 3-1 Linear Vessel Signals	17
Figure 3-2 Non-Linear Vessel Signals	18
Figure 3-3 Non-Linear Vessel Examples	18
Figure 3-4 Sensor Calibration Data	20
Figure 3-5 Current Cal Verification Setup	21
Figure 3-6 Pressure Pump Hookup	22
Figure 3-7 Pressure Cal Verification Hookup	23
Figure 3-8 Field Cal Hookup	25
Figure 3-9 Pressure Pump Hookup	26
Figure 3-10 Pressure Cal Hookup	27
Figure 3-11 HART Communicator Wiring	28
Figure 3-12 HART Command Flowchart	29

Section 1 General

1.1 DESCRIPTION - SL/SX

The model "SL" Liquid Level Transmitter has been specifically designed for placement in Dairy, Food and Beverage applications where accurate and repeatable level measurement is required. The "SX" version, built on the SL platform, is designed specifically to meet the additional specification requirements of the Pharmaceutical and BioPharmaceutical industries.

The SL/SX transmitter measures the static head pressure exerted by the product held in the vessel. It then converts this pressure to a 4-20 mA DC signal that is proportional to the height of the liquid above the sensing portion (diaphragm) of the unit. The resulting signal may be interfaced with Anderson Digital Indicators, Anderson Microprocessor Based Tank Inventory Systems or Customer supplied instrumentation.

Various fitting styles are available to allow adapting the SL/SX to existing sensor shells in a retrofit application. Anderson can also supply weld-in shells for new vessels, or for vessels that do not currently have tank gauging installed. The SL/SX is all welded construction, and is fully 3-A authorized. All wetted parts are constructed of 316L stainless steel, with the remainder of the unit in 304 and 316 stainless steel.

Push button, non-interactive Zero and Span switches provide for quick field calibration and setup. In addition, onboard circuitry handles temperature compensation to ensure a stable reading during all phases of the operation.

The result is the SL/SX Liquid Level Transmitter – meeting the demands of today's industry by providing long term trouble free operation.

1.2 DESCRIPTION - SX

In addition to all of the features listed above, The model "SX" transmitter includes a Certificate of Calibration with each unit. This documentation has been provided to meet the needs of GMP (Good Manufacturing Procedure) programs found in the Pharmaceutical and Bio-Pharmaceutical Industries.

The model SX transmitter may also be wired so that the installation meets Intrinsically Safe requirements. Direct agency approvals are referenced in the upcoming specifications section of this manual. Details of wiring requirements are shown in Appendix B also included herein.

1.3 INTENDED USE

The SL transmitter is only to be used for the application that it has been designed, dimensioned and built for. The electrical connection must be to a direct current network (see the nameplate).

The intended purpose of the SL is the measurement of hydrostatic pressure that is proportional to liquid height in the food processing, beverage, pharmaceutical and chemical industries. This transmitter is not suitable for the measurement of hazardous, explosive, and combustible liquids of the PED group.

Any modifications to the transmitter that might have an influence on the function and the safety features of the transmitter are only allowed to be carried out by authorized persons of Anderson Instrument Company. Possible misuse including any use in contradiction to the above-mentioned application is an indication of misuse of the measuring instrument!

In such a case Anderson does not assume any responsibility for safety.

1.4 SPECIFICATIONS

Level Measurement Range Factory calibrated for ranges between 30 inches and 1385 inches of water column

Rangeability	Minimum	Maximum(URL)	Proof Pressure
SL1 & SL5 and SX5 Series	0-30" WC	0-140" WC	10 psig
SL2 & SL6 and SX6 Series	0-140.1" WC	0-415" WC	30 psig**
SL3 & SL7 and SX7 Series	0-415.1" WC	0-830" WC	60 psig**
SL4 & SL8 and SX8 Series	0-830.1" WC	0-1385" WC	100 psig

** For extended over range capability, SL2 & SL6/SX6 may be factory calibrated for range as low as 0-75"WC (150"WC min for SL3 & SL7/SX7, 300"WC min for SL4 & SL8/SX8)

Calibrated Accuracy	± 0.20% of URL at stable calibration temperature
Repeatability	± 0.075% of URL
Hysteresis	± 0.075% of URL
Linearity (BFSL)	± 0.05% of URL
Calibration Stability	± 0.2% of URL for one (1) year minimum
Resolution	Infinite
Process Temperature Limits	0°F to 265°F (-18°C to 130°C)**
Ambient Temperature Limits	15°F to 120°F (-9°C to 49°C)
Compensated Temperature Range	0°F to 250°F (-18°C to 121°C) (process)
Effect of Process Temperature Change	±0.2% of Upper Range Limit (URL) per 10°F (Zero shift only)
Effect of Ambient Temperature Change	±0.4% of Upper Range Limit (URL) per 10°F (Zero Shift Only)
Excitation	24 VDC (12-36 vdc)
Input Current Rating	35mA
Output	4-20mA dc, 2-wire. Internal test points supplied
Loop Resistance	1550 ohms (max.) at 40 vdc, 750 ohms (max) at 24 vdc
Cable Recommended	
<u>Standard Environment</u>	2 conductor, stranded, 18-24 AWG, shielded with ground. 0.17 - 0.26" Cable Sheath OD for use with field wireable connector.
<u>Harsh Electrical Environment</u>	Shielded Molded Cord Set*
Housing Material	304 and 316 stainless steel
Wetted Parts	316L stainless steel electropolished
Response Time	526 mSec
Communication	
Standard:	Analog, 4-20mA output
Optional:	Analog + Hart digital protocol. Does not support Multidropmode
Agency Approvals (SX Only)	Intrinsically safe for use in Class 1, Div. 1, Groups A-D; CE Compliant
Agency Approvals (SL Only)	ETL Listed Conforms to UL Std 61010-1 3rd Ed(with Hart options) Certified to CSA Std C22.2 61010-1 3rd Ed(with Hart options)
Environmental	
Enclosure Protection	Designed and factory tested to NEMA 4X, IP66, IP67; Suitable for use in wet locations at up to 100% relative humidity.

* For increased immunity to lightning strikes and increased immunity to adverse EMI conditions. Required to meet the following CE standards: IEC61000-4-5 and IEC61000-4-6.

** 0 °F to 250 °F (-18 °C to 121 °C) for fitting options 088, 089, 090, and 091.

FIGURE 1-1 SHELL AND SENSOR DIMENSIONS

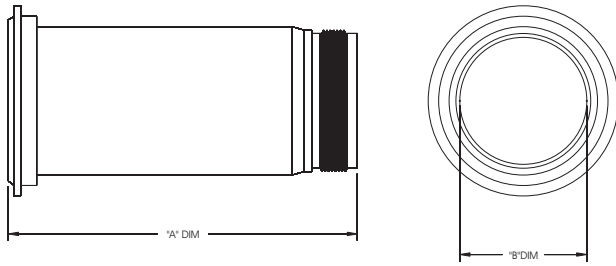

SHELL TYPE

Transmitter Fitting Type	"A" Dimensions	"B" Dimensions
Anderson Long Fitting	6-3/16 inches	2-1/8"
Anderson Short Fitting	1-7/8 inches	2-1/8"
Cherry Burrell Long Fitting	6-3/16 inches	1-1/2"
Cherry Burrell Short Fitting	1-7/8 inches	1-1/2"
King Gage Short Fitting	1-7/8 inches	1-1/16"
King Gage Standard Fitting	6-1/4 inches	1-1/16"
King Gage Long Fitting	8-1/2 inches	1-1/16"
Tank Mate Short Fitting*	3-10/32 inches	1-1/4"
Tank Mate Medium Fitting*	5-15/32 inches	1-1/4"
Tank Mate Long Fitting*	8-11/32 inches	1-1/4"
Rosemount Short Fitting	2-3/32 inches	3-11/16"
Rosemount Long Fitting	6-3/32 inches	3-11/16"

* Requires Adapter
 * Note: Requires special adapter kit

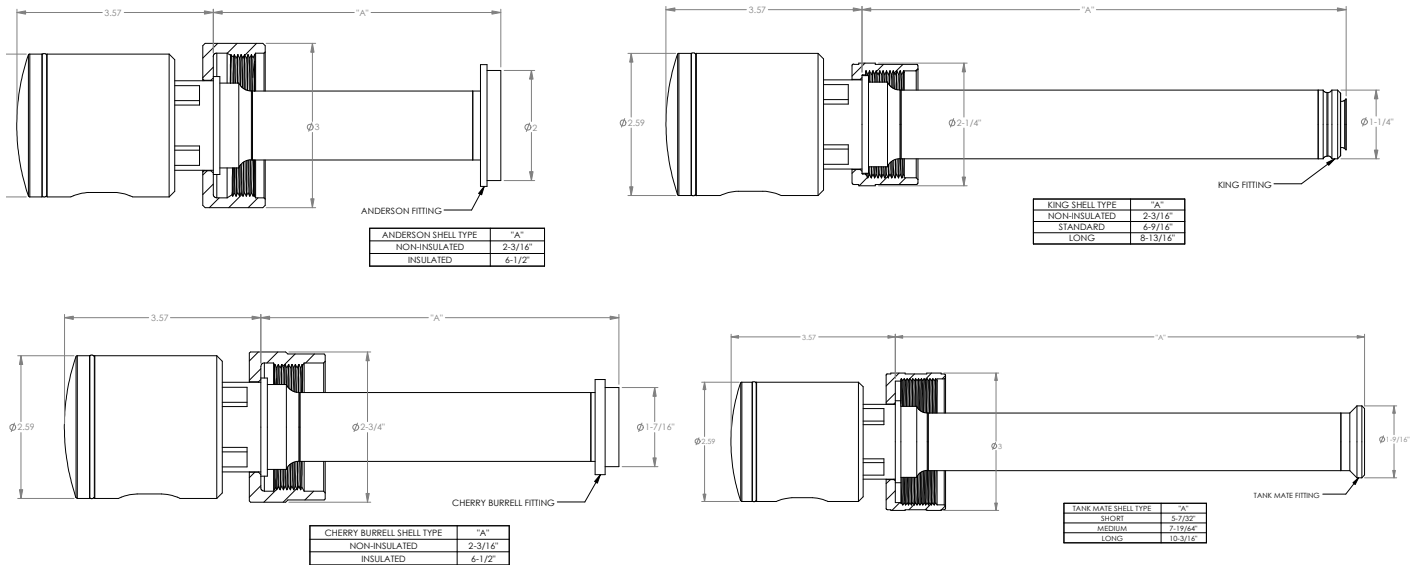

Caution: For proper mounting of this sensor, verify that the fitting connection type, size, gasket or seal, and holding ring or clamp match the process connection it is being mounted to. Improper mounting can cause process leakage, reduced pressure ratings, and/or contamination issues.

FIGURE 1-1 SHELL AND SENSOR DIMENSIONS continued

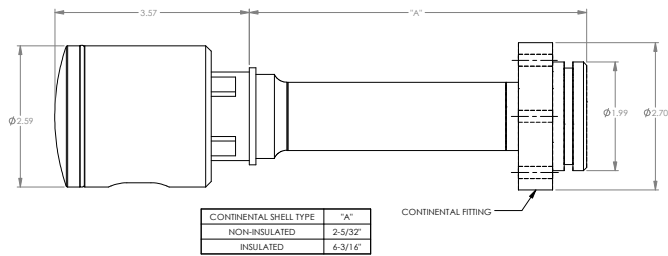
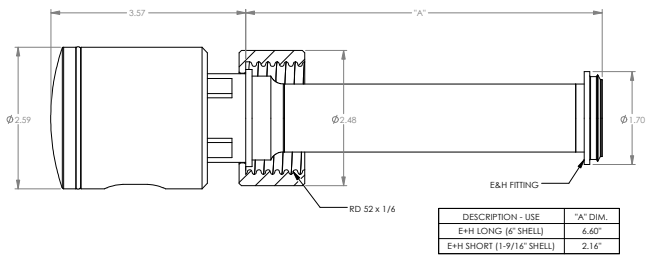
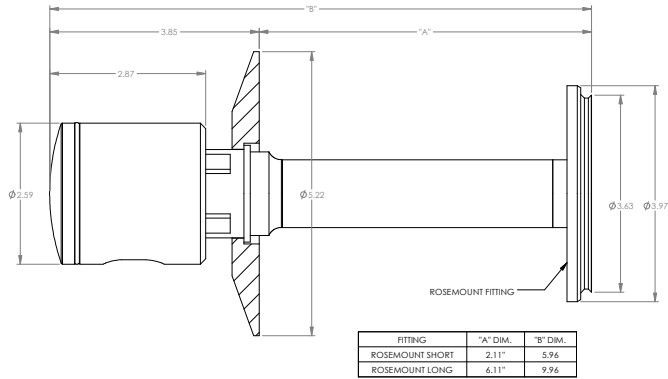
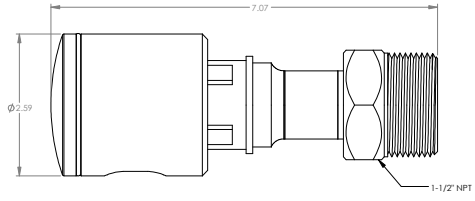
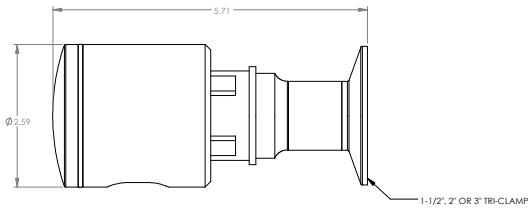

Caution: For proper mounting of this sensor, verify that the fitting connection type, size, gasket or seal, and holding ring or clamp match the process connection it is being mounted to. Improper mounting can cause process leakage, reduced pressure ratings, and/or contamination issues.

Section 2 Installation

2.1 TANK SHELL INSTALLATION

If Anderson flush mount style sensors are to be utilized on a new application, weld-in shells must be installed in the vessel. The shells are provided with an installation guideline sheet. The procedures should be closely followed to preclude shell distortion, damaged threads, or other installation problems. Note that shell location should also be considered. Close proximity to removable agitators or other parts should be avoided.

For new applications and also select retrofit applications, Anderson can supply shell plugs that will allow you to use the tank until a transmitter is in place. Consult the accessory list at the end of this publication for more information.

2.2 INSTALLATION OF LEVEL TRANSMITTER

Caution: For proper mounting of this sensor, verify that the fitting connection type, size, gasket or seal, and holding ring or clamp match the process connection it is being mounted to. Improper mounting can cause process leakage, reduced pressure ratings, and/or contamination issues.

Caution: Handle with care during installation to avoid damage to the sensor. Physical damage, especially to the sensing surface or probe can cause incorrect output signal or premature failure.

Caution: Do not expose the sensor to process or ambient temperatures that exceed the rated specifications. Physical damage, incorrect output signal, or premature failure may result.

Before installation of the transmitter, flush out and wipe clean the inside surface of the weld-in shell. Inspect with a flashlight for any debris or surface damage to the face of the shell. Pay careful attention to the area where the gasket surface meets the shell. Be sure that no sharp edges, gouges, or scrapes exist. In addition, inspect the shell threads for damage prior to transmitter installation.

There are three different gasket types available. The first is a "Tapered" gasket supplied with Anderson and Cherry Burrell fittings (note - gaskets are not interchangeable). Second, an O-ring type gasket is supplied for King Gage style and Tank Mate fittings (note - gaskets are not interchangeable). Lastly, Tri-Clamp® style fittings require a customer supplied gasket.

For sensors with Anderson and Cherry Burrell style fittings, refer to Figure 2-1 for proper installation of the gasket. Be sure that the wide end is slipped into the transmitter first. For King Gage Style and Tank Mate fittings, a rubber O-ring will be supplied. Be sure the O-ring fits snug on the fitting. Do not use standard O-ring gaskets as proper sealing may not occur. For Tri-Clamp® sensors, be sure that the correct gasket is utilized. The gasket should not come in contact with the face of the transmitter diaphragm. Consult the accessory list at the end of this publication for information on spare gaskets.

Once the gasket is properly installed, carefully slide the transmitter into the tank shell.

You may apply Petro-Jel or another food grade lubricant to the threads of the shell prior to threading on the nut. DO NOT lubricate the gasket. The gasket to shell seal should be a dry fit.

CAUTION: Hand tighten the nut only enough to provide adequate seal of the gasket to the shell. Be sure the gasket and transmitter face are flush with the shell on the inside of the vessel. DO NOT over-tighten as this will cause the gasket to bulge into the tank. Carefully inspect for proper seal.

FIGURE 2-1 TAPERED GASKET INSTALLATION

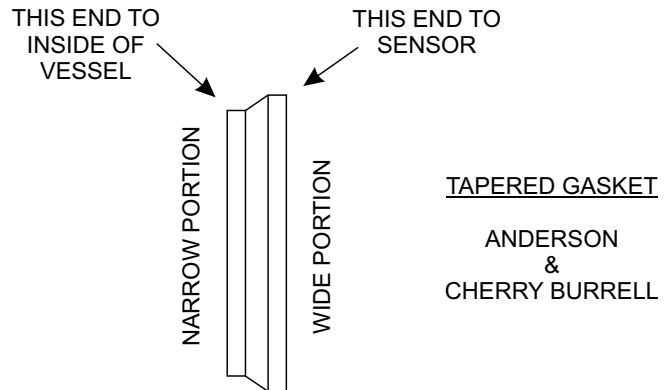
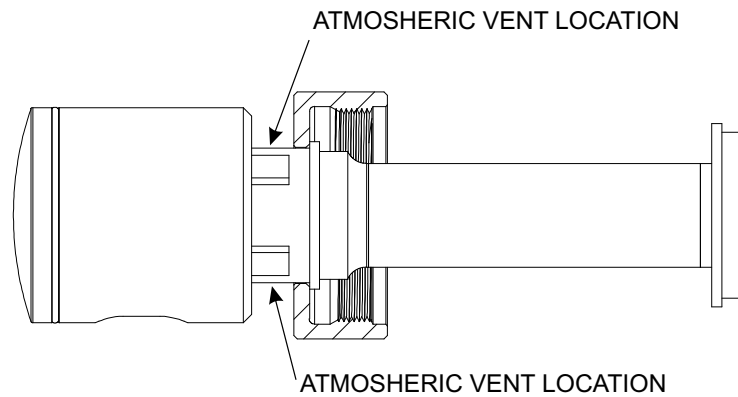

FIGURE 2-2 SENSOR VENTING



2.3 ATMOSPHERIC VENTING

Venting of the backside of the transducer, to negate the effect of atmospheric pressure on the head of the product, is provided via the integral stainless steel vent as shown in Figure 2-2. The four ports should remain open to atmosphere, and free from any foreign materials/product buildup. Water, cleaning solution, etc. is free to flow through the vent area without affecting operation. Sharp objects, brushes or other foreign objects should not be inserted into this area so as not to damage the vent diaphragm.

2.4 ELECTRICAL WIRING



Warning! This unit accepts DC voltage only, connection to AC voltage can cause failure of the sensor and/or risk of electrocution

2.4.1 Signal Cable

Anderson recommends the use of 18-24 AWG, 4 conductor cable. In addition, it should be foil shielded with a continuous drain wire (If Factory supplied, Belden #9534 or equivalent). Although only two conductors and the drain wire are utilized, cable as specified above will retain its roundness when inserted into the seal-tight grommet. This will prevent moisture from entering the Field Wireable Connector. The drain (ground) wire should be attached to ground at only the receiver end. Be sure that this wire is cut back far enough so as not to make connection with any stainless steel inside the conduit head of the sensor. Installation as described will prevent induced ground loop currents from flowing through the drain wire causing errors in the mA signal.

CAUTION: To prevent signal interference, do not run signal cable closer than 12" to AC wiring.

NOTE: If using customer supplied cable, be sure it is 4-8mm(0.16-0.31") OD. The use of larger diameter cable will make entry of the cable in to the Field Wireable Connector difficult, while the use of smaller diameter cable may allow moisture to enter the connector.

2.4.2 Transmitter Power and Wiring

The model SL/SX Level Transmitter requires 12-36 VDC for proper operation. If below 24 VDC, a regulated supply is recommended. The total loop resistive load (signal wire, signal receiver, optional display, but not including transmitter) must not exceed the value given in Figure 2-3 corresponding to the voltage of the DC power supply used. Allow 23.3 ohms per 1000 feet for each conductor of 24 AWG sized wire (the smaller the AWG gauge, the larger the wire cross section).

FIGURE 2-3 REQUIRED SUPPLY VOLTAGES

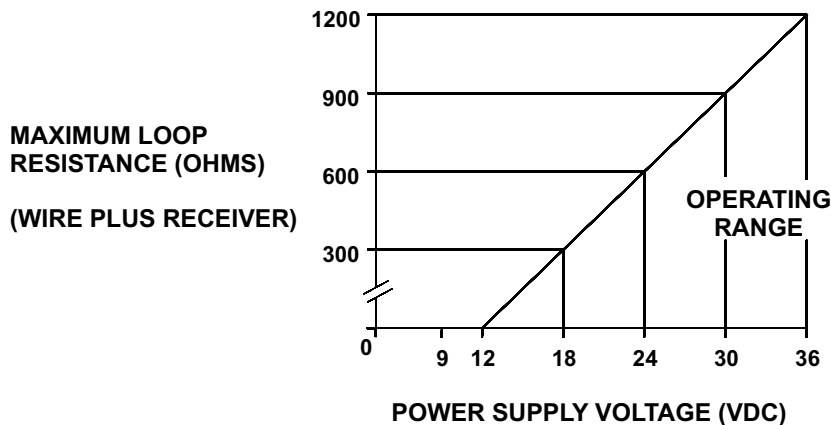
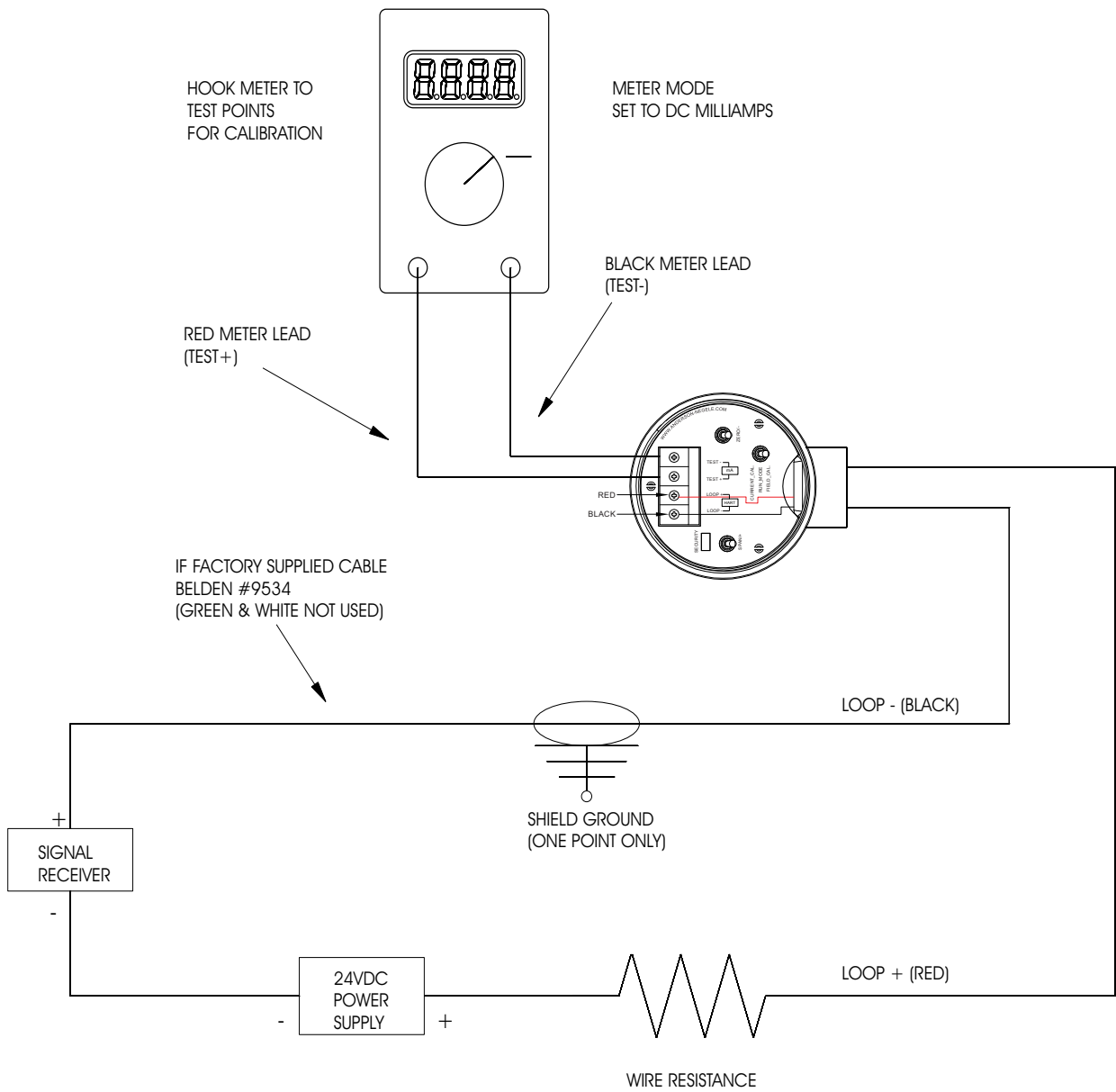

FIGURE 2-4 TRANSMITTER LOOP DIAGRAM



2.5 TRANSMITTER ELECTRONIC "ZERO" CALIBRATION

Upon installation of a new Factory Calibrated unit, prior to the start of Wet Calibration and as part of routine maintenance a Zero calibration adjustment must be performed. The transmitter ZERO, (signal output with no pressure applied to the diaphragm), is 4.00 mA. Although the calibration may be performed without additional tools, testpoints have been provided for monitoring the mA output signal from the transmitter. For maximum accuracy we recommend performing a sensor zero about three (3) weeks after initial installation, or following several heat/cool cleaning cycles. Both vessel and transmitter should be at a stable temperature. Recommend after process prior to CIP.

See Figure 2-5, Zero Calibration Procedure, for the location of the Zero switch. Depressing for 5 seconds automatically "zeros" the output.

CAUTION:

- Field wiring MUST be complete – loop power (12-36 VDC) applied
- Transmitter MUST be installed in vessel
- Verify NO product contact to diaphragm
- Vessel MUST be vented to atmosphere
- DO NOT depress SPAN switch

Once Zero calibration has been performed, sensor output will return to 4.00 mA. This is the proper output to signify an empty vessel – ZERO calibration is complete.

NOTE: No adjustment to the SPAN is necessary. ZERO and SPAN settings are non-interactive, having no effect on each other.

FIGURE 2-5 ZERO CALIBRATION PROCEDURE

Caution: Do not open the sensor enclosure in wet or spray-down environments. Moisture ingress can cause premature electronics failure.

NOTE: RECEIVER AND METER CONNECTIONS OMITTED FOR CLARITY]

REFER TO FIGURE 2-4 FOR HOOKUP

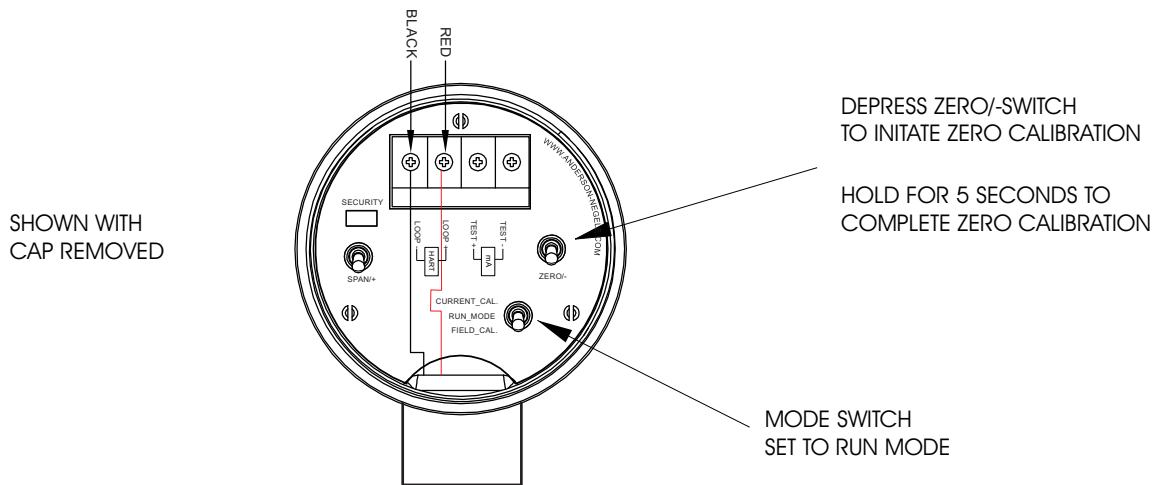

Section 3 Calibration

3.1 FIELD OR "WET" CALIBRATION

Caution: Improper changes to programmed parameters following installation and commissioning can result in incorrect output signal.

Caution: Improper calibration can cause incorrect output signal.

The following section will illustrate various methods for calibration of an SL/SX transmitter. The application of the sensor will determine which calibration method is followed. Be sure to read all information as presented. For additional assistance you may call your authorized Anderson Distributor, or Anderson Instrument Technical Services directly.

3.11 Basics of Tank Geometry

Tank geometry is the first and foremost factor in designing a tank gauging system. In the sections that follow, examples will be given for linear versus non-linear vessels. Each application presents a different set of requirements. Simple straight sided linear vessels may have their sensors interfaced with basic Digital Indicators or Displays. These units simply apply the amount of signal measured, as a percentage against the full span (volume/weight) of the vessel. Non-linear vessels, however, require indicators capable of higher level math functions. Custom lookup (tank tables) tell the indicator what the vessels shape (Volume to Height Ratio) looks like. In this case, sensors must be interfaced with Microprocessor Based Gauging Systems or Programmable Logic controllers (PLC's).

The SL/SX transmitter is designed to output a linear 4-20 mA signal proportional to the height of liquid above it. As the SL/SX signal output is based on vertical head pressure only, the horizontal surface area of the vessel has no effect on the reading.

FIGURE 3-1 LINEAR VESSEL SIGNALS

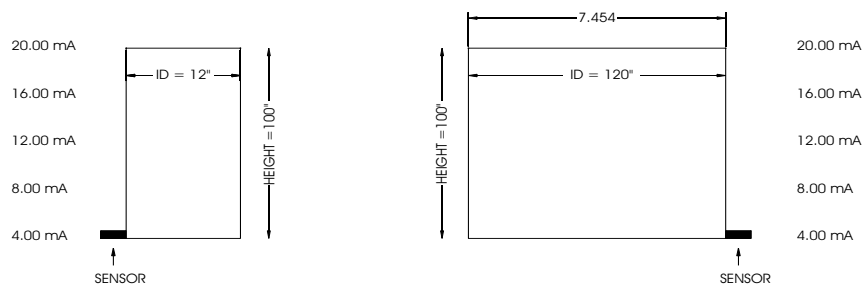

Example: Product=Water (Specific Gravity = 1.00)
 Each vessel is full to top
 Calibration = 20 mA @ 100" Water Column

As you can see from the above figure, it is only the height of the product column that influences the output signal of the SL/SX transmitter. For straight sided linear vessels (Silo type), as in the above figure, sensors may be interfaced with standard Digital Monitors or Programmable Logic Controllers (PLC's) using simple proportional logic.

Example:	Empty tank	4.00 mA	0% Full
	¼ tank	8.00 mA	25% Full
	½ tank	12.00 mA	50% Full
	¾ tank	16.00 mA	75% Full
	Full tank	20.00 mA	100% Full

Vessels that do not have a proportional volume to height ratio are termed non-linear. In these cases, the SL/SX continues to reference ONLY the height of the liquid column above it. The signal is NOT proportional to the non-linear volume to height differences.

FIGURE 3-2 NON-LINEAR VESSEL SIGNALS

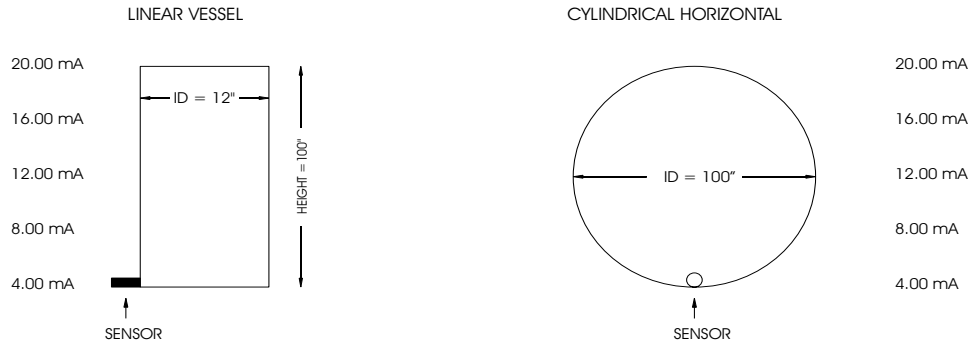

Example: Product=Water (Specific Gravity = 1.00)
 Each vessel is full to top
 Calibration = 20 mA @ 100" Water Column

As you can see in the above figure, when comparing a linear vessel (Silo) to a non-linear vessel (Horizontal Cylindrical), the sensor output appears unchanged. However, if we attempt to apply proportional calculations to the non-linear tank, the resulting values will not be correct. For example, 25% of height is 25% of volume in a linear vessel, but 25% of height is NOT 25% of volume in a non-linear vessel. It is for these reasons that a display capable of performing calculations will be required to convert sensor output to usable volume / weight data. In this case a Microprocessor based Gauging System, or PLC based system will be required.

The common examples of non-linear vessels are shown in the following figure. Again, mathematical lookup tables will be required to convert (Linearize) the signal output from the SL/SX.

FIGURE 3-3 NON-LINEAR VESSEL EXAMPLES

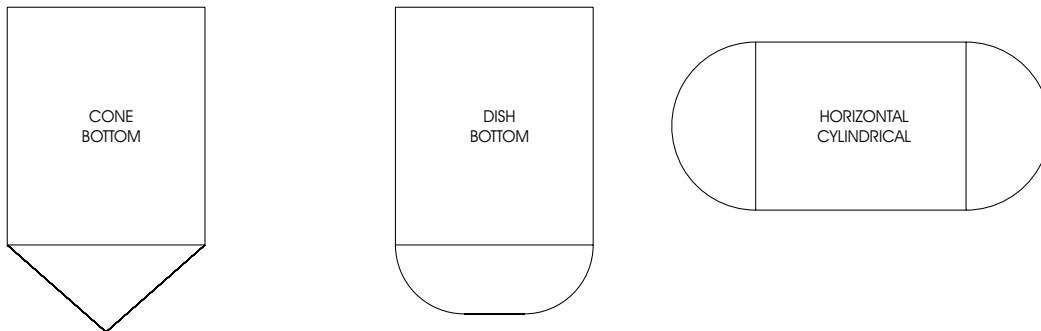

3.12 Basics of Specific Gravity

The effects of product Specific Gravity also plays a major role in setting up a gauging system. Specific gravity is nothing more than the weight of the product versus the weight of water.

Example:

- Water = 8.345 Pounds Per Gallon
- Raw Milk = 8.62 Pounds Per Gallon

- Water Specific Gravity = $8.345 \div 8.345 = 1.00$
- Raw Milk Specific Gravity = $8.62 \div 8.345 = 1.032$

- Water is always used as the base reference
- As you can see, Raw Milk is .032 greater than water
- In other words, Milk is approximately 3.2% heavier than water

The resulting number, if less than 1.00 signifies that a product is lighter than water, and conversely if greater than 1.00 signifies a product that is heavier than water. As the Anderson SL/SX transmitter is a pressure based device, specific gravity of a given product directly influences the resulting signal output of the unit. In a basic application, with a product in a vessel that remains constant, a sensor may be calibrated specifically for that product. If a lighter or heavier product is placed into the vessel, the output signal will change. In applications where it is known up front that multiple products will be held in the vessel, indicators capable of higher level math functions will again be required (Microprocessor based systems or PLC's). In these applications, calculations must be made to compensate for products of varying specific gravities.

3.2 SENSOR FACTORY CALIBRATION OVERVIEW



Warning! Do not remove this sensor from the process while it is operating. Removal while the process is operating can contaminate the process and could cause human injury.

Caution: Attempting to disconnect or change wiring to this sensor during process operation can cause loss of signal to the control system!

Caution: Do not open the sensor enclosure in wet or spray-down environments. Moisture ingress can cause premature electronics failure.

Unless an SL/SX Sensor is going to be utilized in a vessel where a field Wet Calibration (Tank Table Development) is going to take place, it is shipped from Anderson pre-calibrated. The calibrated range of the transmitter is generally determined from either a tank print supplied by the Customer / Distributor, or by actual measurements gathered by the Customer / Distributor. This information, used in conjunction with the product specific gravity, transmitter orientation and process temperature are used to provide a unit factory calibrated to the actual application.

The calibration measurement range of a transmitter, as ordered from the above information, is etched on the body of the unit along with a corresponding model and serial number.

FIGURE 3-4 SENSOR CALIBRATION DATA

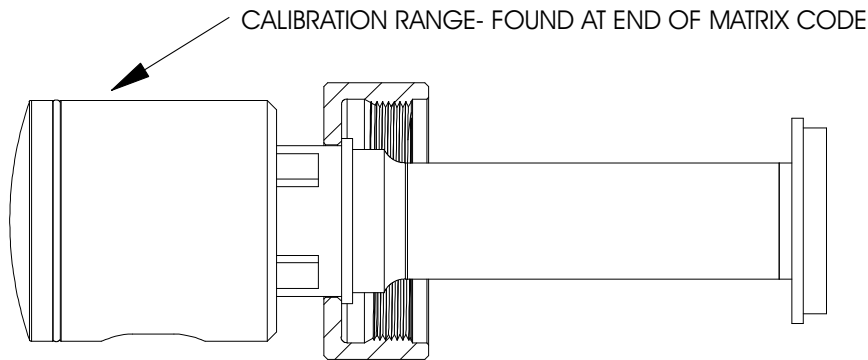

Example:

- Vertical storage tank for Ice Cream Mix
- Product Specific Gravity = 1.15
- Straight side height above sensor = 100 inches
- Calibration = 100" x 1.15 = 115.0" Water Column
- It is at this value that the sensor has been set to output full scale signal, or 20.00 mA

When calibrating at the factory, the sensor is oriented as it will be in the vessel, since changes in the angle of the sensor will cause "zero offset". The sensor is then ZEROED to a 4.00 mA output with no pressure applied. Next, a pressure equal to the maximum pressure exerted by a full tank of product is placed on the diaphragm. The sensor is then SPANNED to a 20.00 mA output at this pressure.

27.7" Water Column = 1 psig Pressure



Warning! Do not subject this sensor to pressure that exceeds the specified upper range limit. Over-pressure may cause premature failure, incorrect output signal, or possible human injury.

NOTE: Once installed in the vessel, the sensor ZERO must be reset. At that point, the unit will be ready for operation.

3.3 CALIBRATION VERIFICATION - UTILIZING ON-BOARD SETUP

Utilizing a digital multimeter attached to the on-board testpoints, the SL/SX transmitter may be switched to an alternate output mode whereas the signal viewed on the meter is proportional to the current calibration range of the transmitter. Hookup is as follows:

FIGURE 3-5 CURRENT CAL VERIFICATION HOOKUP

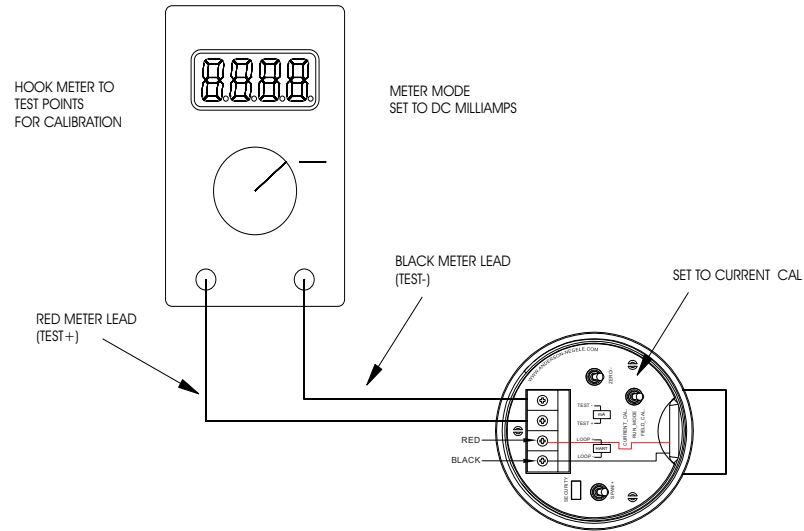

NOTE: PROPER LOOP WIRING MUST BE ESTABLISHED, NOT SHOWN FOR CLARITY.

As shown, set operating switch to CURRENT CAL position. The signal displayed on the meter at this point is directly proportional to the current SPAN setting of the sensor. Using the following procedure, this value can be converted to the "Inches of Water Column" calibration value:

1. Determine **Max Sensor Range** for the model that is being tested
(First numeric digit in Model Number – stamped on side of transmitter)
 - Model SL1 & SL5/SX5: Max Sensor Range = 145
 - Model SL2 & SL6/SX6: Max Sensor Range = 420
 - Model SL3 & SL7/SX7: Max Sensor Range = 835
 - Model SL4 & SL8/SX8: Max Sensor Range = 1390
2. Perform calculation to determine current inches of Water Column calibration

$$[(\text{Meter Reading} - 4.00) \div 16] \times \text{Max Sensor Range} = \text{Current Cal in "WC}$$
3. Once calibration has been determined, move switch back to RUN position to continue operation
4. If value determined matches value in model number, unit is properly calibrated
5. If value does not match value in model number, sensor calibration has been altered since unit left the factory – see sections that follow for proper re-calibration procedures

CAUTION: Placing unit in CURRENT CAL may cause alarms and valve switches.

3.4 CALIBRATION VERIFICATION - UTILIZING EXTERNAL PRESSURE SOURCE

If available, an external pressure calibrator may be used to determine the current calibration of a sensor. Test procedure is as follows:

FIGURE 3-6 PRESSURE PUMP HOOKUP

DIGITAL PRESSURE CALIBRATOR
(SUGGESTED UNIT)

CRYSTAL ENGINEERING
PHONE: 800-444-1850

MODEL: 212-030PSI-G-HR

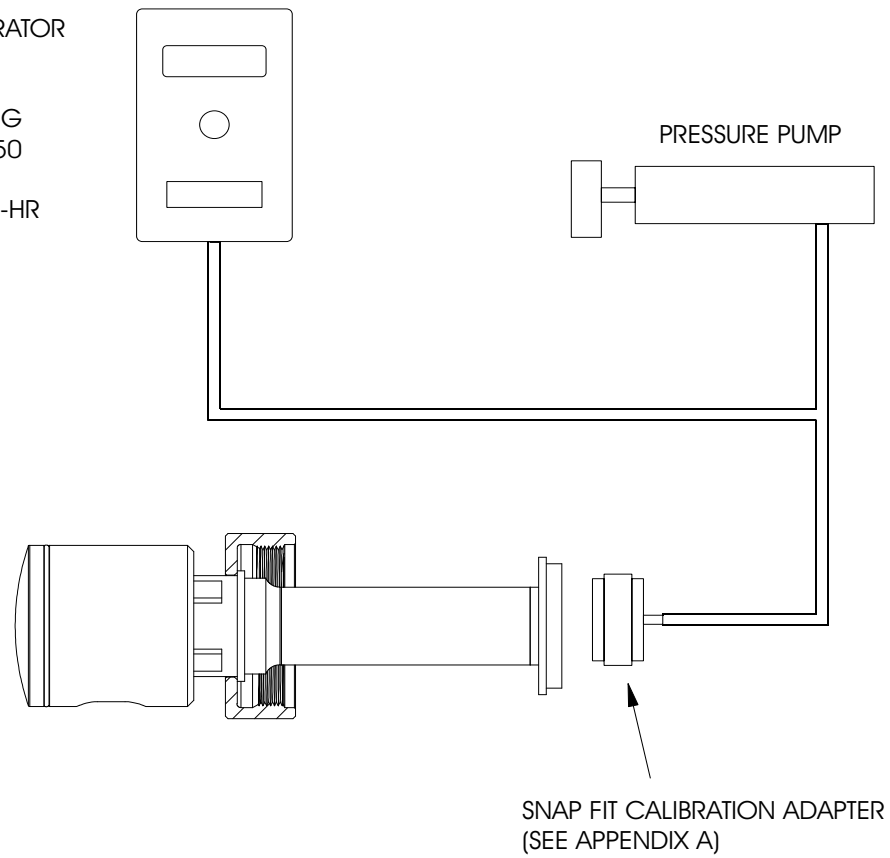

SNAP FIT CALIBRATION ADAPTER
(SEE APPENDIX A)

FIGURE 3-7 PRESSURE CAL VERIFICATION HOOKUP

Caution: Do not open the sensor enclosure in wet or spray-down environments. Moisture ingress can cause premature electronics failure.

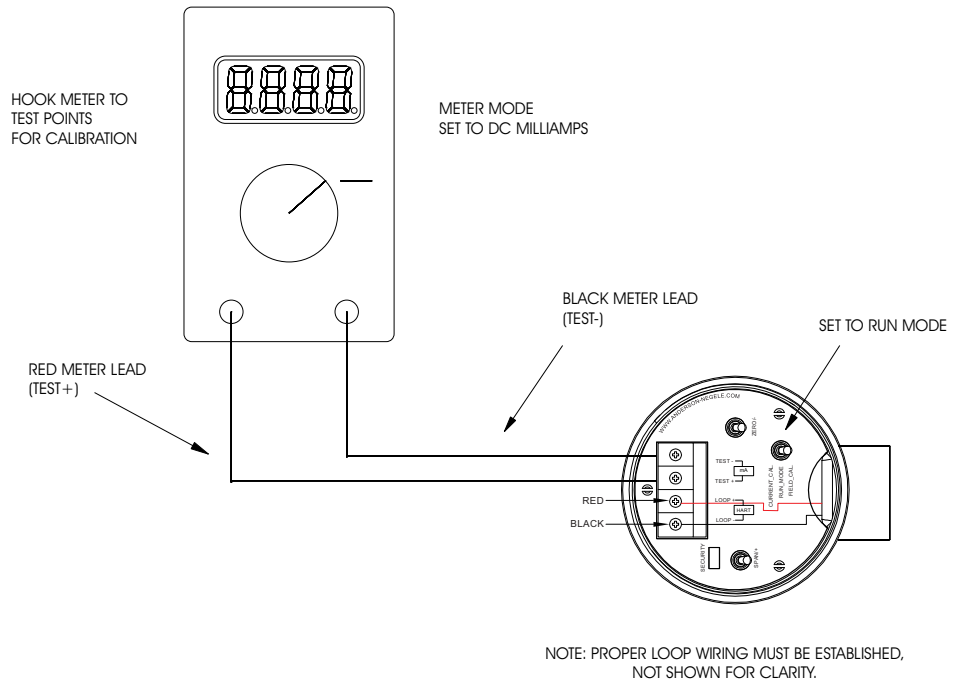

1. Remove sensor from vessel if already installed – leave loop wiring attached
2. Provide loop power to sensor if performing a bench test
3. Attach snap fit calibration adapter to sensor fitting (Available from Anderson)
4. Sensor MUST remain stationary, with no movement
5. Perform ZERO calibration as described in this manual
6. Set pressure calibrator to proper range
7. Set multimeter to 4-20 mA DC scale, make connections at “TEST +” and “TEST -” testpoints
8. Using pressure pump, increase pressure until 20.00 mA is seen on the multimeter
9. Read “Water Column” from Pressure Calibrator – this is current sensor calibration
10. If value determined matches value etched on side of sensor, calibration ok
11. If value does not match value in model number, sensor calibration has been altered since unit left the factory – see sections that follow for proper re-calibration procedures

3.5 CALIBRATION - UTILIZING ON-BOARD SETUP

Caution: Do not open the sensor enclosure in wet or spray-down environments. Moisture ingress can cause premature electronics failure.

The SL/SX transmitters utilize on-board "Setup" circuitry to perform maintenance and calibration. With these tools, in addition to a digital multimeter, it is possible to perform a field calibration / re-calibration of the output range.

Note:

- Use caution if altering factory calibration – no record will exist at Anderson pertaining to changes
- Calibration MUST remain within range parameters of unit – be sure to refer to tables provided
- Loop power MUST be supplied to sensor

Tools Required: Digital Multimeter
Calculator

1. Determine **Sensor Cal Max** for the model that is being calibrated
(Model determined from first numeric digit in model number – stamped on side of transmitter)

Model SL1 & SL5/SX5: Sensor Cal Max = **145** Full Operating Range = 0-30" to 140" WC
Model SL2 & SL6/SX6: Sensor Cal Max = **420** Full Operating Range = 140.1 to 415" WC
Model SL3 & SL7/SX7: Sensor Cal Max = **835** Full Operating Range = 415.1 to 830" WC
Model SL4 & SL8/SX8: Sensor Cal Max = **1390** Full Operating Range = 830.1 to 1385" WC

NOTE: When re-calibrating a unit, you must remain within unit FULL OPERATING RANGE

Example:

- An SL1/SL5/SX5 series unit currently set to 20 mA @ 88" WC
- This unit can be calibrated as low as 30" WC Span to a Max of 140" WC span

2. Determine **Desired Calibration**, in Inches of Water Column ("WC)

Example: Height Above Sensor In Inches (100") x
Specific Gravity of Product (1.032) = 103.2"WC

3. Determine **Current Cal Value** for calibration using the following formula:

$$[[[STEP 2 VALUE \div STEP 1 VALUE] \times 16] + 4.00] = \text{New Current Cal Value}$$

Note: Record new Current Cal Value for your records

4. Perform meter hookup as shown in the following figure – Set **MODE SWITCH** to **FIELD CAL** position

FIGURE 3-8 FIELD CAL HOOKUP

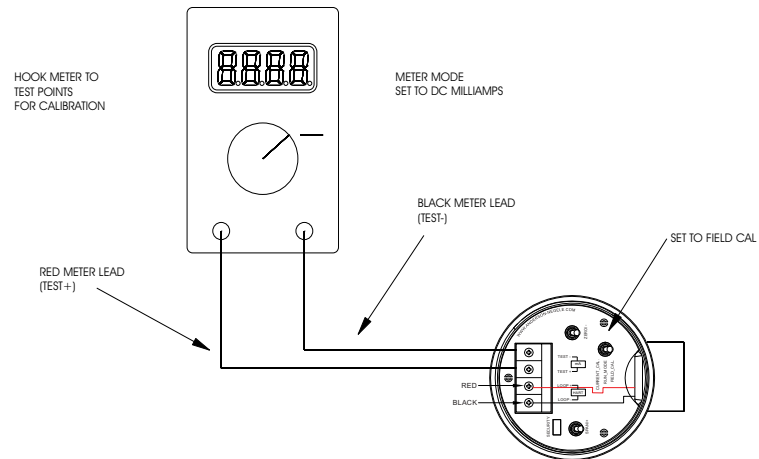

5. Meter output will automatically move to 19.99 – sensor is waiting for entry of new calibration range
6. **SPAN** switch secondary function is “+”, and the **ZERO** switch secondary function is “-”
7. Using these two switches, raise or lower the value currently displayed on the meter until the value determined in step three (3) has been reached
8. Once the proper value has been reached, simultaneously depress **BOTH** the **SPAN/+** and the **ZERO/-** switches for **one (1) second** – this will lock in new sensor calibration
9. Place Mode Switch in "Current Cal" position and verify meter is reading value determined in step three (3). If value is correct proceed to step ten (10), if value is incorrect repeat process beginning at step four (4).
10. Calibration complete - mode switch set to "**RUN MODE**" position - place unit back into vessel - perform "**ZERO**" calibration

CAUTION: Placing unit in FIELD CAL may cause alarms and valve switches.

3.6 CALIBRATION - UTILIZING EXTERNAL PRESSURE SOURCE

Caution: Improper calibration can cause incorrect output signal.

If available, an External Pressure Calibrator may be used to perform a field calibration / re-calibration of the range on the SL/SX Series Transmitter.

Note:

- Use caution if altering factory calibration – no record will exist at Anderson pertaining to changes
- Calibration MUST remain within range parameters of unit – be sure to refer to tables provided
- Loop power MUST be supplied to sensor

Tools Required: Pressure Calibrator (Equivalent to unit as described)
Digital Multimeter

1. Determine if desired range is within Full Operating Range of sensor
(Model determined from first numeric digit in model number – stamped on side of transmitter)

Model SL1 & SL5/SX5:	Full Operating Range = 0-30" to 140" WC
Model SL2 & SL6/SX6:	Full Operating Range = 140.1 to 415" WC
Model SL3 & SL7/SX7:	Full Operating Range = 415.1 to 830" WC
Model SL4 & SL8/SX8:	Full Operating Range = 830.1 to 1385"WC

2. Perform hookup of pressure calibrator as shown in the following figure – orient sensor in a location where easy access may be made to the internal setup switches

FIGURE 3-9 PRESSURE PUMP HOOKUP

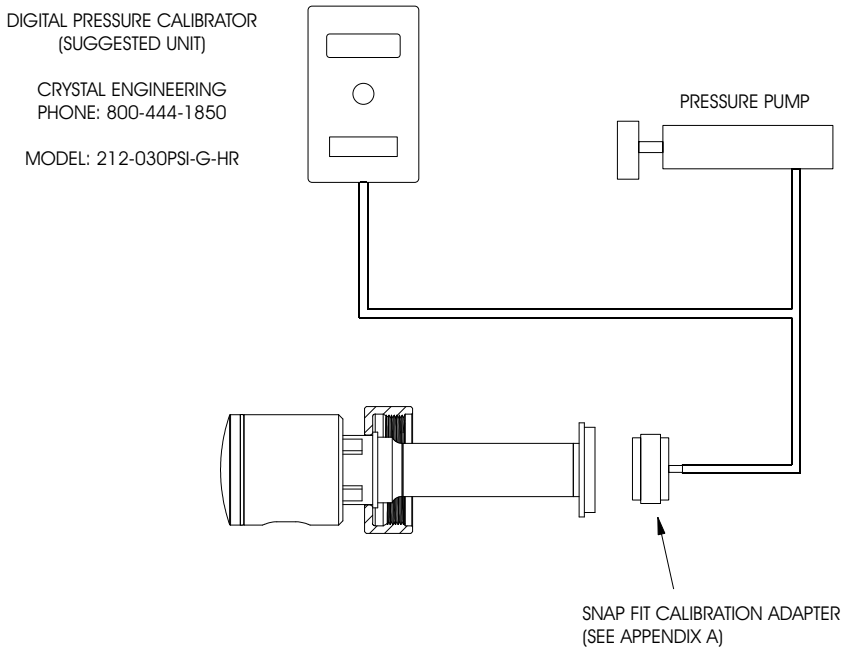

3. Perform hookup of Multimeter as shown in the following figure:

FIGURE 3-10 PRESSURE CAL HOOKUP

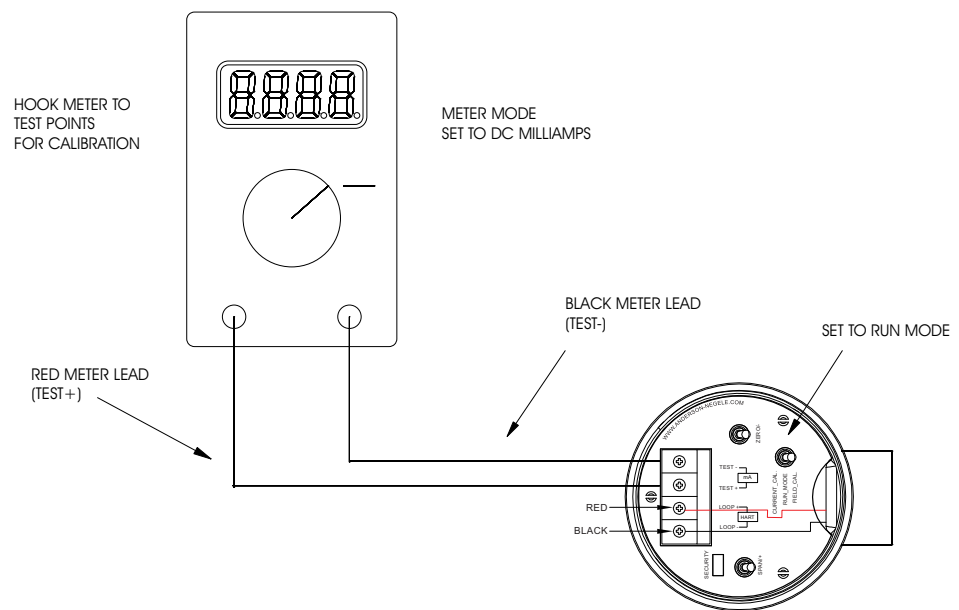

4. Sensor **MUST** remain stationary, with no movement
5. Perform **ZERO** calibration – depress **ZERO** switch for five (5) seconds – meter will show 4.00 mA
6. Using Pressure Pump, apply desired pressure to sensor
7. Once desired pressure has been achieved, depress **SPAN** switch for five (5) seconds – this will program new calibration range
8. Release calibration pump pressure
9. Be sure mA meter reading returns to 4.00 mA – If not, sensor orientation may have moved while performing calibration, return to step 5 and repeat process
10. Momentarily place Mode Switch to "Current Cal" position and record meter reading for your records. Return Mode Switch to Run Mode and proceed to step eleven (11).
11. Install sensor back into vessel and perform a ZERO calibration – unit is ready for service at this time

3.7 CALIBRATION - UTILIZING HART COMMUNICATOR

Caution: Improper changes to programmed parameters following installation and commissioning can result in incorrect output signal.

Security jumper must be in place to change settings utilizing a HART Communicator (HHT). HHT must be connected to the loop. Test terminals do not carry the HART signal. Follow the procedure below:

ZERO TRIM

- 1.) Power the transmitter, confirm transmitter is installed and tank is empty. The signal loop must have atleast 250 ohms resistance for HHT function.
- 2.) Connect the "HART" HHT across the transmitter terminals, or the resistor in the loop.
- 3.) Turn on the HHT , wait until communications are established and the Home Menu is displayed.
- 4.) If the Process Value is not with in specification after stabilization:
 1. Select Device Setup
 2. Select Detail Setup
 3. Select Sensors
 4. Select Pres Sensor
 5. Select Sensor Trim
 6. Select Zero Trim
 7. Observe Warning Select OK
 8. Observe Warning Select OK
 9. Verify Tank Empty Select OK
 10. Sensor is now zero'd Select OK
 11. From Sensor Trim Menu Select Home to return to Home Menu
 12. Verify Process Value is now within specification

SENSOR RERANGE
UTILIZING KEYPAD

1. Select Device Setup
2. Select Basic Setup
3. Select ReRange
4. Select Keypad ReRange
5. Select PV URV
6. Enter New Value, Select Enter
7. Select Send
8. Observe Warning Select OK
9. Observe Warning Select OK
10. New Value has now been accepted by sensor
11. From Keypad ReRange menu Select Home to return to Home Menu

UTILIZING APPLIED PRESSURE

1. Select Device Setup
2. Select Basic Setup
3. Select ReRange
4. Select Apply Values
5. Observe Warning, Select OK
6. Select 20mA
7. Pressurize sensor to desired URV, Select OK
8. Confirm Process Value Display, Select Enter
9. Select Exit
10. Observe Warning, Select OK
11. From ReRange Menu Select Home to return to Home Menu

FIGURE 3-11 HART COMMUNICATOR WIRING

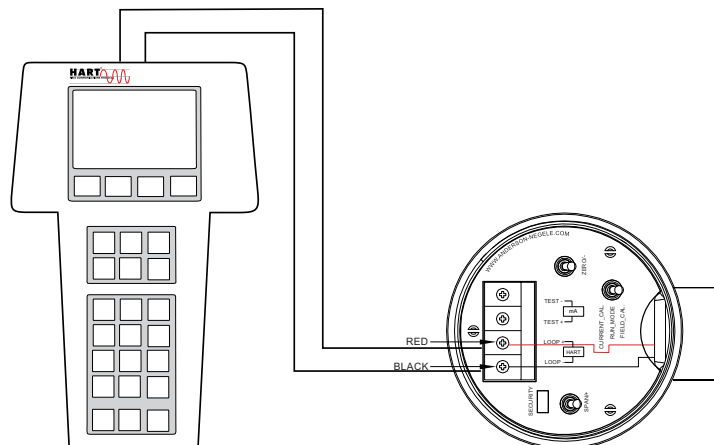

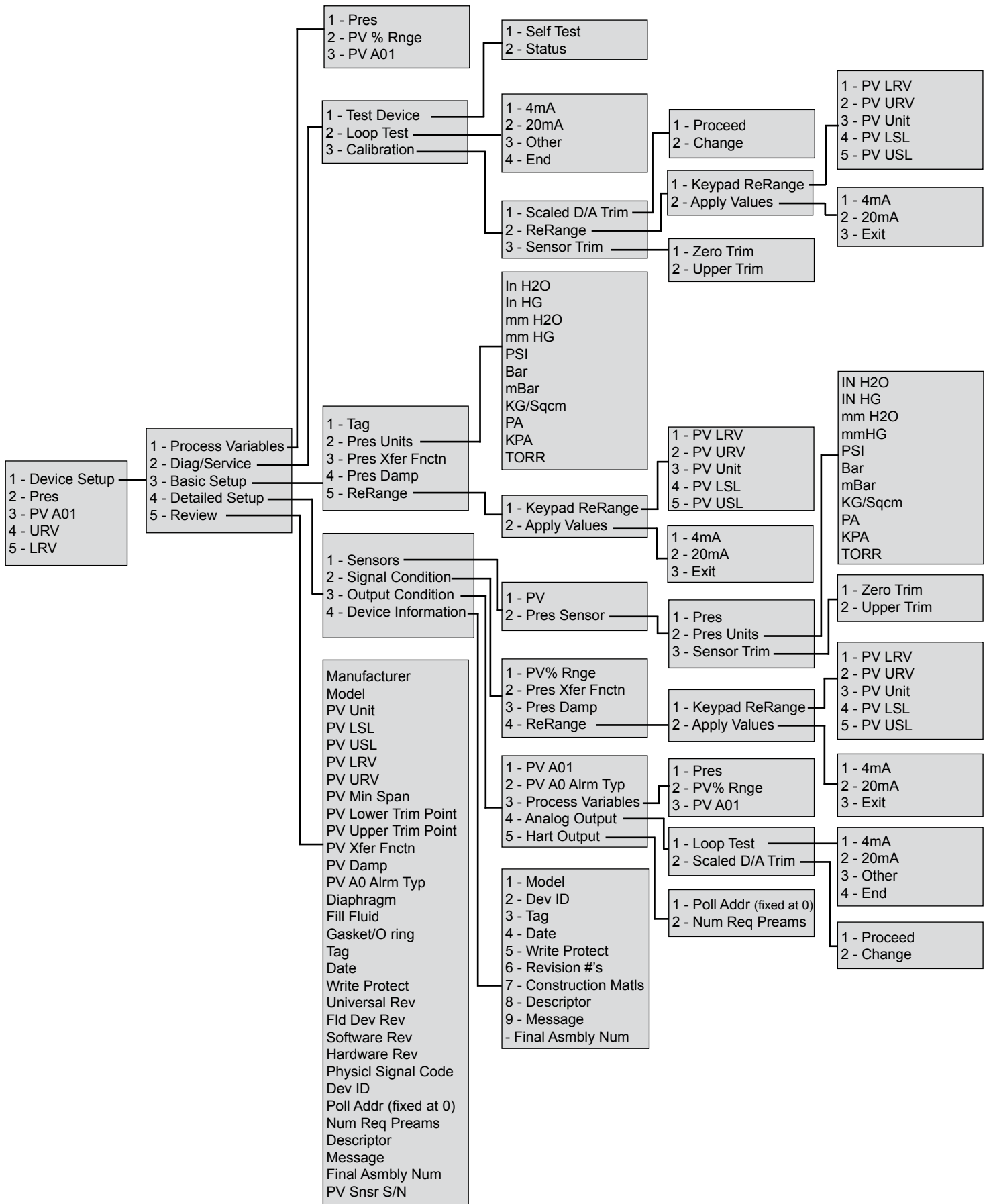

Section 4 Maintenance and Troubleshooting



Warning!

Before removing for service or calibration, ensure that tank is empty.

4.1 GENERAL

Required maintenance of the SL/SX transmitter includes a yearly calibration program, along with routine visual verification of the venting system integrity. In addition, a visual check of the diaphragm and gasket should take place at minimum-6 month intervals. Small dents in the diaphragm will cause a "pre-load" or positive zero offset, which generally can be adjusted out. Larger dents, creases, or punctures are very detrimental and may require a complete repair or replacement.

NOTE: The transmitter should be left in place for normal cleaning operations. Removal of the unit opens risk for damage to the diaphragm area. If the transmitter must be removed, a protective cap should be immediately placed over the diaphragm area. Be sure that the cap does not press on the diaphragm directly. The external surfaces of this sensor can be cleaned along with the equipment or piping system that it is installed on, using cleaning and disinfecting solutions designed for use on hygienic equipment.

4.2 CALIBRATION CHECKS

To maintain proper accuracy, Anderson recommends **yearly** ZERO signal (4.00 mA) checks. A record of these readings will help to maintain a consistent schedule. If re-zeroing does not correct inaccuracies seen in the receiver, calibration of the receiver itself should be performed. Consult associated manuals for your individual equipment.

CAUTION: Unless performing full calibration of the unit, do not adjust the "SPAN". This adjustment is Factory set. Testing of the transmitter "SPAN" will require stepping through one of the procedures outlined in the Calibration section (section 3) or the use of a stand alone pressure calibration system. The unit may also be returned to the factory for calibration. Call Anderson Technical Services directly for further information.

CAUTION: Verify that the sensor is operating properly after re-installation, and prior to start-up of control system. When power is first applied, signal should read 4.00mA before any hydrostatic pressure is applied.

4.3 VENT SYSTEM

The model SL/SX Level Transmitter utilizes an integral stainless steel atmospheric vent. The system vent must be maintained to allow for proper operation of the unit.

- Be sure the atmospheric vent area is not obstructed. These ports must be open and free from debris. **DO NOT** use sharp objects to free foreign material from this area. Flush with warm-low pressure water.

4.4 GASKETS

Anderson recommends that gaskets be changed once a year. It is important that the holding nut not be over tightened when reinstalling a transmitter. Forcing the nut will push the gasket into the tank. Always do a visual check from the inside of the vessel to be sure the gasket is properly sealed.

NOTE: If you are utilizing Teflon gaskets, these gaskets must be discarded each time the transmitter is removed from the tank. Unlike standard silicone gaskets, Teflon material retains any imperfections resulting from scratches or damage in the shell surface. When utilized again, the imperfections may result in an unsanitary seal.

4.5 TROUBLESHOOTING

As with any current loop, power supply and loop continuity are both imperative. If a problem occurs, a methodical approach, beginning at the power supply is best.

4.5.1 Troubleshooting Steps

1. Measure power supply voltage across "loop+" and "loop-" terminals. Meter will read between 12 and 36 VDC. (meter set to DC volts)
2. Disconnect one wire (+) from the signal receiver and install an accurate milliamp meter in series with the receiver. The signal should correspond proportionally to the height of liquid in the tank. (meter set to DC mA)
3. If step 1 and 2 are satisfactory, the problem is with the receiver. (If supplied by Anderson, refer to the instruction manual for that instrument).
4. Check all wiring connections between loop components. If OK, proceed to step 5.
5. With loop disconnected, the next step is to determine if there is a short to the housing. This is accomplished by placing the (+) lead of the ohm meter on the loop+ terminal, and the (-) lead to the housing. The process should then be reversed. In both cases, the meter should register infinite resistance. The process should then be repeated on the loop- terminal of the sensor. Again, the meter should register infinite resistance. If test is OK, proceed to step 6,
6. Wire transmitter independently of loop using two 9 volt batteries for power and milliamp meter as a receiver. If signal is proper, approximately 4mA with no product on sensor, then problem is with external wiring.

NOTE: Be sure to observe proper polarity as described in Figure 2-4

If any of the above indicate a transmitter problem, call your local distributor, or Anderson Technical Service directly.

NOTE: Tank shell "plugs" are available from the factory if a tank must be used while the sensor is out for repair. Contact the Technical Service Department at 1-518-922-5315 for details. Have the transmitter serial number on hand to expedite shipping of the proper plug.

Appendix A - Spare Parts and Accessories

Weld-In Tank Shells (for new applications)

Anderson Long Shell - 316L Stainless	71060A0003
Anderson Short Shell - 316L Stainless	71060A0004
Anderson Long for ASME Pressure Vessel	71060A0005
Anderson Short for ASME Pressure Vessel	71060A0006
Anderson Long Shell - Hastelloy	71060A0007
Anderson Short Shell - Hastelloy	71060A0008
Anderson Long Heavy-Duty for ASME Pressure Vessel	71060A0009

Tank Shell Plugs (supplied with nut and gasket)

Anderson Long Tank Shell Plug	56511B0001
Anderson Short Tank Shell Plug	56511B0002
Cherry Burrell Long Tank Shell Plug	56511A0001
Cherry Burrell Short Tank Shell Plug	56511A0002
King Long Tank Shell Plug	56511C0001
King Medium Tank Shell Plug	56511C0002
King Short Tank Shell Plug	56511C0003
Tank Mate Long Tank Shell Plug	56511D0001
Tank Mate Medium Tank Shell Plug	56511D0002
Tank Mate Short Tank Shell Plug	56511D0003

Level Sensor Replacement Gaskets

Anderson Style Sensor - Silicone Rubber	44348A0001	(this gasket std)
Anderson Style Sensor - Teflon®	44348B0001	
Cherry Burrell Style Sensor - Silicone Rubber	44292A0001	(this gasket std)
King Gage Style Sensor - Rubber "O" Ring	36240S0212	(this gasket std)
Tank Mate Style Sensor - Rubber "O" Ring	36240S0123	(this gasket std)
Continental - 2 Rubber "O" Rings	5658900000	(this gasket std)
Endress + Hauser - EPDM	45352B0001	(this gasket std)
Rosemount - Rubber "O" Ring	36240E2341	(this gasket std)

Existing Shell Adaptor Kits

Tank Mate Shell Adaptor (provides threaded connection for sensor)	
For insulated (medium and long length) shells	57200A0001
For Un-insulated (short) shells	57200A0002

Calibration Adaptor

- Provide quick connect fitting to sensor - for use with field pressure calibration equipment
- Provides sensor-to-female threaded connection

Anderson Style Fitting Calibration Adapter	73198A0001
Cherry Burrell Style Fitting Calibration Adapter	73198A0002
King Gage Style Fitting Calibration Adapter	73198A0003
Tank-Mate Style Fitting Calibration Adapter	73198A0004

Appendix B

Intrinsically Safe Requirements for SX Transmitter

The following drawing illustrates additional requirements which must be met in order to properly wire an SX transmitter to be recognized as Intrinsically Safe. Specifications which must be met when choosing a barrier strip have been provided.

NOTE: Anderson does not offer barrier strips for sale at this time - please see your local electrical component supplier.

CAUTION:

ALL documented requirements **MUST** be met. An SX wired without a barrier strip will not meet the guidelines for Intrinsically Safe applications.

HAZARDOUS AREA
CLASS I
GROUPS A, B, C, D

REVISIONS		44506H0001	
CHANGE NO.	DESCRIPTION	BY	DATE
A	99-022 RELEASED	TUG	3/25/99
B	02-031 MODEL # 155 (FITTING) WAS 097	TUG	3/12/02

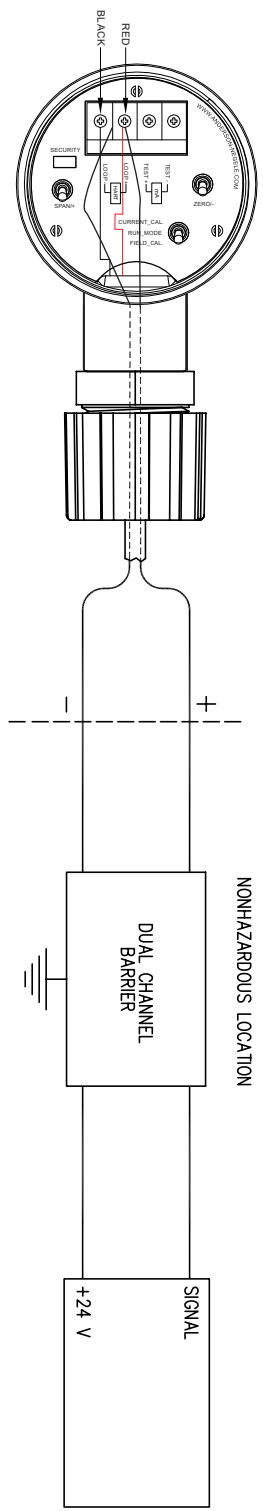

V max = 40 VDC
I max = 165 mA
Ci = 0 uF
Li = 0 uH
Cc = Cable Capacitance
Lc = Cable Inductance

- NOTES:**
- SEE OPERATING INSTRUCTIONS.
 - ASSOCIATED APPARATUS MUST NOT BE CONNECTED IN PARALLEL UNLESS PERMITTED BY THE ASSOCIATED APPARATUS APPROVAL.
 - WARNING - SUBSTITUTION OF COMPONENTS MAY IMPAIR INTRINSIC SAFETY.
 - CAPACITANCE AND INDUCTANCE OF FIELD WIRING FROM THE TRANSMITTER TO THE BARRIER SHOULD BE CALCULATED AS (Cc = 60pF/FT AND Lc = 0.2uH/FT) AND SHOULD BE INCLUDED IN THE SYSTEM CALCULATIONS.

MODEL NUMBERS
SX - 5 - 004 - 1 - 0 - 00 - 00000
THRU THRU 24

- NOTES ON BARRIERS**
- MAY BE IN A DIVISION 2 LOCATION IF SO APPROVED.
 - OUTPUT CURRENT MUST BE LIMITED BY A RESISTOR SUCH THAT THE OUTPUT VOLTAGE-CURRENT PLOT IS A STRAIGHT LINE DRAWN BETWEEN OPEN CIRCUIT VOLTAGE AND SHORT CIRCUIT CURRENT.
 - CABLE CAPACITANCE PLUS INTRINSICALLY SAFE EQUIPMENT CAPACITANCE MUST BE LESS THAN THE MARKED CAPACITANCE (Cc) SHOWN ON ANY BARRIER USED. THE SAME APPLIES FOR INDUCTANCE.
 - SELECTED BARRIERS MUST BE THIRD PARTY APPROVED AND HAVE Voc OR Vt NOT EXCEEDING Vmax AND Isc OR It NOT EXCEEDING Imax AS SHOWN FOR EACH TYPE OF BARRIER IN THE TABLE BELOW.

- NOTES ON CONTROL**
- MAINS POWER MUST NOT EXCEED 250 VOLTS WITH RESPECT TO EARTH.

Equipment	Barrier
V max	Voc
I max	Isc
Ci+Cc	Ca
Li+Lc	La

<p>THE INFORMATION CONTAINED HEREON IS CONFIDENTIAL AND MAY NOT BE COPIED OR DISCLOSED TO OTHERS WITHOUT WRITTEN CONSENT FROM ANDERSON INSTRUMENT CO., INC.</p>	
<p>NEXT ASSY: -N/A- SCALE: NONE MATERIAL: -N/A- FINISH: -N/A- *** UNLESS OTHERWISE SPECIFIED *** ALL DIMS. ARE IN INCHES BREAK CORNERS 0.05 MAX. ALL SURFACES ✓ Tolerances are: 3 P.L.C. DEC. ±.004 2 P.L.C. DEC. ±.000</p>	<p>PROPRIETARY INFORMATION THIS DRAWING IS THE PROPERTY OF ANDERSON INSTRUMENT CO., INC. 158 Audubon Rd., Fiddletown, New York, 10072, USA</p>
<p>DESIGNED BY: TUG CHECKED BY: TUG DATE: 3/23/99</p>	<p>TITLE: CONTROL DRAWING LEVEL: TRANSMITTER Sx</p>
<p>Sheet No. 1 of 1 Date: 3/25/99</p>	<p>44506H0001 REV. B</p>

Appendix C

Warranty and Return Statement

These products are sold by The Anderson Instrument Company (Anderson) under the warranties set forth in the following paragraphs. Such warranties are extended only with respect to a purchase of these products, as new merchandise, directly from Anderson or from an Anderson distributor, representative or reseller, and are extended only to the first buyer thereof who purchases them other than for the purpose of resale.

Warranty

These products are warranted to be free from functional defects in materials and workmanship at the time the products leave the Anderson factory and to conform at that time to the specifications set forth in the relevant Anderson instruction manual or manuals, sheet or sheets, for such products for a period of two years.

THERE ARE NO EXPRESSED OR IMPLIED WARRANTIES WHICH EXTEND BEYOND THE WARRANTIES HEREIN AND ABOVE SET FORTH. ANDERSON MAKES NO WARRANTY OF MERCHANTABILITY OR FITNESS FOR A PARTICULAR PURPOSE WITH RESPECT TO THE PRODUCTS.

Limitations

Anderson shall not be liable for any incidental damages, consequential damages, special damages, or any other damages, costs or expenses excepting only the cost or expense of repair or replacement as described above.

Products must be installed and maintained in accordance with Anderson instructions. Users are responsible for the suitability of the products to their application. There is no warranty against damage resulting from corrosion, misapplication, improper specifications or other operating condition beyond our control. Claims against carriers for damage in transit must be filed by the buyer.

This warranty is void if the purchaser uses non-factory approved replacement parts and supplies or if the purchaser attempts to repair the product themselves or through a third party without Anderson authorization.

Returns

Anderson's sole and exclusive obligation and buyer's sole and exclusive remedy under the above warranty is limited to repairing or replacing (at Anderson's option), free of charge, the products which are reported in writing to Anderson at its main office indicated below.

Anderson is to be advised of return requests during normal business hours and such returns are to include a statement of the observed deficiency. The buyer shall pre-pay shipping charges for products returned and Anderson or its representative shall pay for the return of the products to the buyer.

Approved returns should be sent to: ANDERSON INSTRUMENT COMPANY INC.
156 AURIESVILLE ROAD
FULTONVILLE, NY 12072 USA

ATT: REPAIR DEPARTMENT

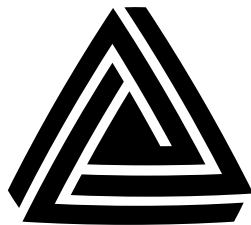

ANDERSON-NEGELE

ANDERSON INSTRUMENT CO., INC • 156 AURIESVILLE RD. • FULTONVILLE, NY 12072 • USA • 800-833-0081 • FAX 518-922-8997
ANDERSON INSTRUMENT CO. LP • 400 BRITANNIA RD. EAST, UNIT 1 • MISSISSAUGA, ONTARIO L4Z 1X9 • CANADA • 905-603-4358 • FAX 905-568-1652
NEGELE MESSTECHNIK GmbH (A Division of Anderson) • RAIFFEISENWEG 7 • D-87743 EGG A. D. GÜNZ • GERMANY • +49 (0) 8333/9204-0 • FAX +49 (0) 8333/9204-49

www.anderson-negele.com