

SENSORS FOR FOOD AND LIFESCIENCE.



HYGIENIC BY DESIGN

ANDERSON-NEGELE

OPERATING MANUAL

Paperless Process Recorder

Table of Contents

| | | |
|----------|---|-----------|
| 1 | General Information | 5 |
| 1.1 | Abbreviations and Acronyms..... | 5 |
| 1.2 | Important Safety Information..... | 6 |
| 2 | Introduction and General Information..... | 10 |
| 2.1 | System Overview | 11 |
| 2.1.1 | PPR Network Communication..... | 11 |
| 2.1.2 | PPR Record Creation and Data Storage | 12 |
| 2.1.3 | PPR Record Layout..... | 13 |
| 2.1.4 | PPR Record Approval Workflow | 16 |
| 2.1.5 | Run/Program Jumper and Sealing Covers..... | 17 |
| 2.1.6 | STLR Hot Product Sensor (STLR Only) | 19 |
| 2.1.7 | STLR Recording and Control (STLR Only)..... | 19 |
| 2.1.8 | SFLR Recording and Control (SFLR Only)..... | 20 |
| 2.1.9 | STLR Diagnostic Circuitry (STLR Only) | 21 |
| 2.2 | Unpacking..... | 21 |
| 2.3 | Order Matrix/Model Number | 23 |
| 2.4 | Specifications..... | 24 |
| 2.5 | Warranty and Return Statement | 25 |
| 3 | Installation and Wiring..... | 26 |
| 3.1 | Mounting..... | 26 |
| 3.1.1 | Panel Mounting | 26 |
| 3.1.2 | Surface/Wall Mounting | 28 |
| 3.2 | Preparation for Wiring..... | 30 |
| 3.3 | Circuit Board and Terminal Identification/Locations | 33 |
| 3.4 | Wiring Connections – System Power | 34 |
| 3.5 | Wiring Connections – Inputs..... | 34 |
| 3.5.1 | mA Input..... | 35 |
| 3.5.2 | 100Ω RTD Input - General..... | 36 |

| | | |
|----------|--|-----------|
| 3.5.3 | 1000Ω RTD Input – STLR Only | 37 |
| 3.5.4 | Voltage Input | 38 |
| 3.5.5 | Sensor Break and Error Detection | 39 |
| 3.6 | Wiring Connections - Outputs | 40 |
| 3.6.1 | Relay Output – General | 41 |
| 3.6.2 | SFLR Relay Output – SFLR Only | 41 |
| 3.6.3 | Current Output | 42 |
| 3.7 | STLR Relay Board – STLR Only..... | 43 |
| 3.8 | Network Wiring | 45 |
| 4 | Basics of Recorder Operation | 45 |
| 4.1 | Commissioning PPR | 45 |
| 4.1.1 | PPR Configuration..... | 45 |
| 4.1.2 | Legendary™ Connection | 46 |
| 4.2 | Startup procedure | 47 |
| 4.3 | Common Screens..... | 48 |
| 4.3.1 | Navigation Bar | 48 |
| 4.3.2 | Home Screen | 48 |
| 4.3.3 | View Chart Screen | 52 |
| 4.3.4 | User Authentication..... | 53 |
| 4.3.5 | Version Information..... | 55 |
| 4.3.6 | System Activity Log..... | 57 |
| 4.4 | Common Interactions | 58 |
| 4.4.1 | User Login/Logout | 58 |
| 4.4.2 | Reviewing Process Data/Trend | 58 |
| 4.4.3 | Adding Annotations to PPR Records | 58 |
| 4.4.4 | Reviewing Records and Approval Workflow Status..... | 63 |
| 4.4.5 | Reviewing and Closing Tasks..... | 64 |

| | | |
|----------|---|-----------|
| 4.4.6 | Approving a Record | 65 |
| 4.4.7 | Changing User's PIN | 66 |
| 4.5 | Recommended Preventative Maintenance | 68 |
| 5 | Configuration | 68 |
| 5.1 | Network Configuration | 68 |
| 5.1.1 | Connectivity Status and Troubleshooting | 71 |
| 5.2 | Date & Time | 72 |
| 5.2.1 | Daylight Savings Time | 73 |
| 5.3 | Input Configuration | 74 |
| 5.3.1 | Input Parameters and Fields | 74 |
| 5.3.2 | Changing Input Configuration | 77 |
| 5.4 | Recorder Configuration | 77 |
| 5.4.1 | Recorder Setup Parameters | 78 |
| 5.4.2 | Record Configuration | 80 |
| 5.4.3 | STLR / SFLR Setpoints (STLR and SFLR Configuration Only) | 81 |
| 5.4.4 | STLR Record Configuration - STLR Only | 83 |
| 5.4.5 | SFLR Record Configuration | 83 |
| 5.4.6 | Record Naming Convention | 84 |
| 5.4.7 | Annotations Setup | 85 |
| 5.5 | System Info/Annotation Configuration | 85 |
| 5.6 | Output Configuration | 87 |
| 5.7 | Alarm Configuration | 88 |
| 6 | Calibration | 91 |
| 6.1 | Input Calibration | 91 |
| 6.2 | mA Output Calibration | 92 |
| 7 | Troubleshooting | 93 |

1 General Information

1.1 Abbreviations and Acronyms

| | |
|----------|---|
| STLR | Safety Thermal Limit Recorder |
| SFLR | Safety Flow Limit Recorder |
| RTD | Resistance Temperature Detector |
| mA | milli-Amp |
| mV | milli-Volt |
| CIP | Clean-In-Place |
| COP | Clean-Out-of-Place |
| PPR | Paperless Process Recorder |
| SOM | System on Module, main PPR microcontroller |
| HTST | High Temperature Short Time |
| UHT | Ultra-High Temperature |
| PMO | Pasteurized Milk Ordinance |
| PCQI | Preventive Controls Qualified Individual |
| NC | Normally Closed |
| NO | Normally Open |
| PLC | Programmable Logic Controller |
| LD | Legendary™ Software |
| Admin | Administrator |
| REST API | representational state transfer Application Programming Interface |
| DHCP | Dynamic Host Configuration Protocol |
| DNS | Dynamic Name Server |
| TLS | Transport Layer Security |
| HTTPS | Hypertext Transfer Protocol Secure |
| IoT | Internet of Things |
| WORM | Write Once Read Many |
| HMI | Human Machine Interface (Touchscreen Display) |
| eMMC | embedded Multi-Media Controller |

| | |
|----------|--------------------------|
| AN & A-N | Anderson-Negele |
| LVD | Low Voltage Directive |
| PE | Protective Earth |
| W | Watt |
| TPS | Transmitter Power Supply |

1.2 Important Safety Information

This instrument has been designed and tested in accordance with IEX Publication 1010-1, Safety requirements for electrical equipment for measurement, control, and laboratory use. It corresponds as well to the CENELEC regulations EN61010-1. All case and chassis parts are connected to the safety earth conductor corresponding to Safety Class 1 regulations (three-conductor AC power cable). A separate 24VDC / $\geq 2A$ power supply that meets all the protection requirements of EN61010 must be used for the recorder. A sufficiently dimensioned protective conductor connection is to be led to the device, which is to be connected to the protective conductor connection terminal provided for this purpose.

Warning!

Any interruption of the protective conductor inside or outside the instrument or disconnection of the protective earth terminal is likely to render the instrument dangerous. Intentional interruption is prohibited. Use caution to prevent any loose or foreign objects from entering the PPR enclosure. Failure to follow this guidance and other instructions within this manual may result in personal injury or death.

If the equipment is used in a manner not specified by the Anderson-Negele, the electrical and safety protection provided by the equipment may be impaired.

[Avertissement!]

[Toute interruption du conducteur de protection à l'intérieur ou à l'extérieur de l'instrument ou déconnexion de la borne de terre de protection est susceptible de rendre l'instrument dangereux. L'interruption intentionnelle est interdite. Faites preuve de prudence pour éviter que des objets lâches ou étrangers ne pénètrent dans le boîtier du PPR. Le non-respect de ces instructions et des autres instructions contenues dans ce manuel peut entraîner des blessures corporelles ou la mort.]

Si l'équipement est utilisé autrement que spécifié par Anderson-Negele, la protection électrique et de sécurité fournie par l'équipement peut être altérée.

The instrument must be disconnected and secured against unintentional operation if there is any suggestion that safe operation is not possible. This may occur:

- If the instrument shows visible damage,
- If the instrument has loose parts,
- If the instrument does not function,

- After long storage under unfavorable circumstances (e.g. outdoors or in moist environments),
- After excessive transportation stress (e.g. in poor packaging).

When removing or replacing the metal case the instrument must be completely disconnected from all power supplies. If any measurement or calibration procedures are necessary on the opened-up instrument, these must only be carried out by qualified personnel acquainted with the danger involved.

Symbols marked on equipment are shown in Figure 1 below;



Figure 1: Safety Symbol Description

The symbol shown in Figure 1 with the text “Caution Refer to Manual” has the following meaning: IDENTIFIES CONDITIONS OR PROCEDURES, WHICH IF NOT FOLLOWED, COULD RESULT IN SERIOUS DAMAGE OR FAILURE OF THE EQUIPMENT. REFER TO MANUAL FOR GUIDANCE ON PROPER OPERATION.

[Le symbole illustré à la Figure 1 avec le texte “Caution Refer to Manual” signifie: IDENTIFIE LES CONDITIONS OU LES PROCÉDURES QUI, SI ELLES NE SONT PAS SUIVIES, POURRAIENT ENTRAÎNER DE GRAVES DOMMAGES OU UNE DÉFAILLANCE DE L'ÉQUIPEMENT. RÉFÉREZ-VOUS AU MANUEL POUR DES CONSEILS SUR LE FONCTIONNEMENT CORRECT.]

The symbol shown Figure 1 with the text “WARNING High Voltage” has the following meaning: IDENTIFIES CONDITIONS OR PROCEDURES, WHICH IF NOT FOLLOWED, COULD RESULT IN SERIOUS INJURY. RISK OF ELECTRICAL SHOCK.

[Le symbole illustré à la Figure 1 avec le texte “WARNING High Voltage” signifie: IDENTIFIE LES CONDITIONS OU LES PROCÉDURES QUI, SI ELLES NE SONT PAS SUIVIES, POURRAIENT ENTRAÎNER DES BLESSURES GRAVES. RISQUE DE CHOC ÉLECTRIQUE.]

Description of Protective Earth (PE) Connection:

Wherever voltages are in the LVD range (>50VAC), PE lines must be connected to PE Terminals on the PE bar as seen in Figure 2, and also grounded separately. Furthermore, these lines must be secured with strain reliefs as described in the section below.

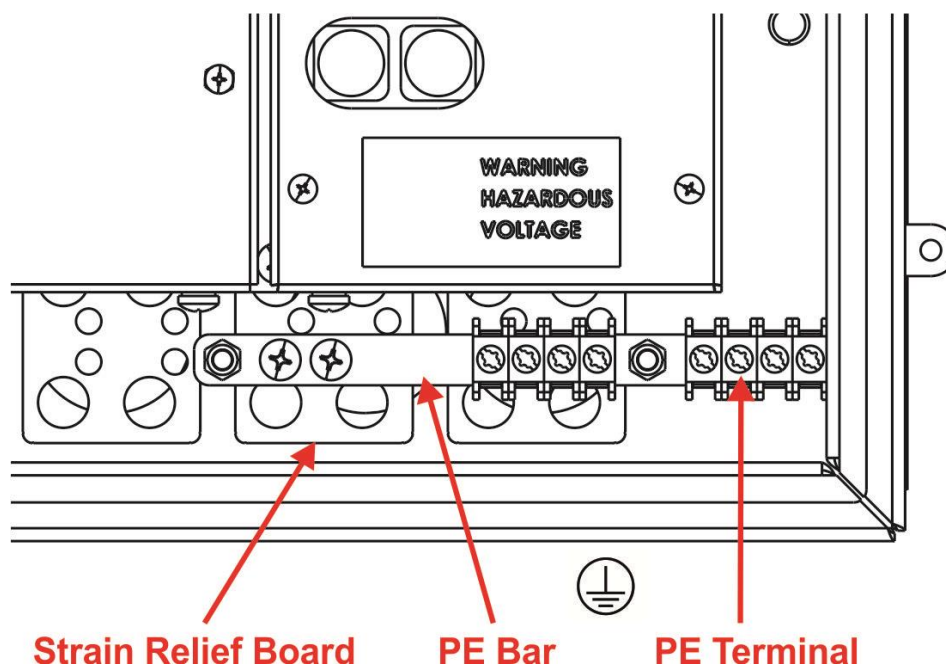

Figure 2: PE Bar and Terminals

Cable Strain Relief

To ensure the safety of our customers a strain relief is essential. These strain relief boards protect cables with dangerous voltages from being pulled out. Therefore, all cables with voltages greater than 50VAC should only be routed to the outside of the PPR enclosure via the strain reliefs.

The strain relief board provided with the PPR (Spare part kit number: 57245A0001) has different options for various cable diameters. The larger holes are designed for cable diameters from 4.5mm to 10mm. The smaller holes are designed for cable diameters from 2.5mm to 5mm. Figure 3 shows how cables with the previously mentioned cable diameters should be installed. If the high voltage cables coming into PPR have diameters smaller than 2.5mm, they should be installed like it is shown in Figure 4 below.

Please check if the cables have been installed correctly by pulling the cables twice towards the outside of the PPR enclosure. If they slip, either a smaller hole should be chosen, or the cables should be fed through the strain relief multiple times as shown in Figure 4.

It is important that the strain relief is installed on the cable as close as possible to the rubber grommets on the inside of the PPR so that the strain relief will function properly.

The cables should not be wired into the PPR in tension so that there is still some available cable for the strain relief to grip.

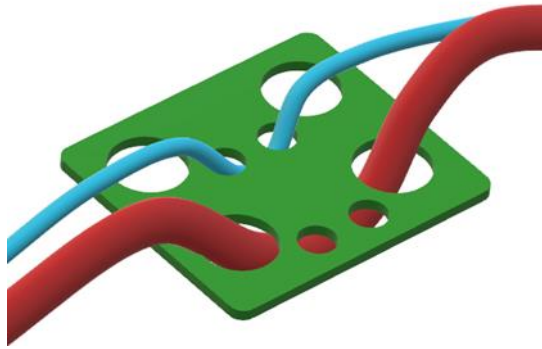

Figure 3: Strain Relief for Small and Large Diameter Cable

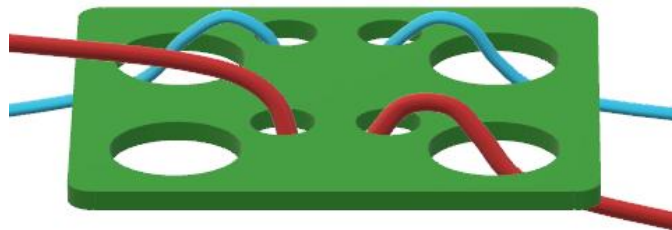

Figure 4: Strain Relief for Small Diameter Cable

Additional Safety Requirements for Installation

To ensure the safe operation of this product always ensure it is installed and used in accordance to the limitations stated below.

| | |
|---|--|
| Supply Voltage Range | 20-30 VDC |
| Power supply Frequency | 0Hz (DC Power) |
| Current Rating | 2A max |
| Maximum Altitude | 2000 meters |
| Over Voltage Category | CATII |
| Degree of Contamination of the intended environment | Pollution degree 2: Normally only non-conductive pollution occurs. |
| Operational Environment | Intended for Indoor use |

2 Introduction and General Information

The Anderson-Negele PPR (Paperless Process Recorder) and Legendary™ cloud software is an innovative solution to help you streamline recording of process data, creation and management of legal records, and secure storage of those records for state and third-party audit.

The PPR and Legendary™ cloud software eliminates many problems of current paper recorders. By providing digital solution for charts and eliminating moving mechanical parts PPR ensures that your production does not get hampered due to mechanical parts failure, printing hardware or paper chart issues. It completely eliminates recurring hardware costs for print arms, motors, print cartridges, and paper charts and reduces costly equipment failures and maintenance cost.

The PPR and Legendary™ cloud software is much more than data trends being tracked in a data logger or historian solution. By providing workflows to create digital charts embedded with digital annotations and providing intuitive process to review and approve records, PPR and Legendary™ helps your plant and quality team get audit ready for internal, State or third-party audits.

Key Benefits

- Create audit ready digital records that meet both your internal and PMO requirements
- Streamlined annotation and approval workflow for both on-premise PPR and Legendary™ cloud software
- Intuitive digital annotation including list of pre-populated common annotations
- Supervisors, quality team and PCQI can remotely review records, request additional notes from operators, and approve records
- Secure storage and access of all historical records for authorized users

Applications

- Continuous pasteurization in HTST, HHST, UHT and Aseptic ranges
- Batch/ Vat pasteurization
- Cold Product Recording
- Clean-In-Place (CIP)
- Clean-Out-of-Place (COP)
- Juice Pasteurization
- Egg Pasteurization
- Ultraviolet (UV) Pasteurization
- Extended Shelf Life (ESL) Applications
- Cold Product Storage Temperature
- General Process Recording and Monitoring

2.1 System Overview

Solution Components

Creating a Legal, Digitalized Workflow

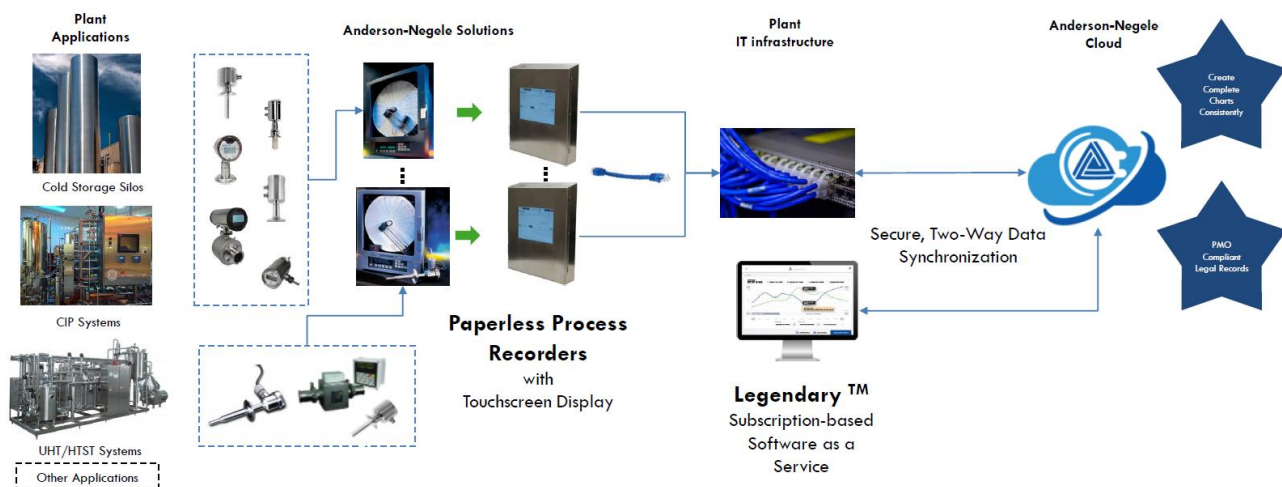

Figure 5: PPR and Legendary™ Solution Components

2.1.1 PPR Network Communication

The PPR is an IoT device and must be installed and connected to the internet to take advantage of Legendary™ Cloud Software. On premise server connections are not available with PPR.

The PPR uses a network connection to enable REST API to periodically push record image data to the Legendary™ cloud server and receive information from Legendary™ such as approvals, users, and annotations through HTTPS with all communication initiating at the PPR. Figure 6 below provides additional detail regarding what information is transferred between PPR and Legendary™ and how the communication is enabled through ethernet. Additional information about the Network Configuration can be found in Section 5.1 of this manual.

No configuration or calibration changes can be performed through the Ethernet connection to PPR, these actions must be performed by a user through the PPR HMI.

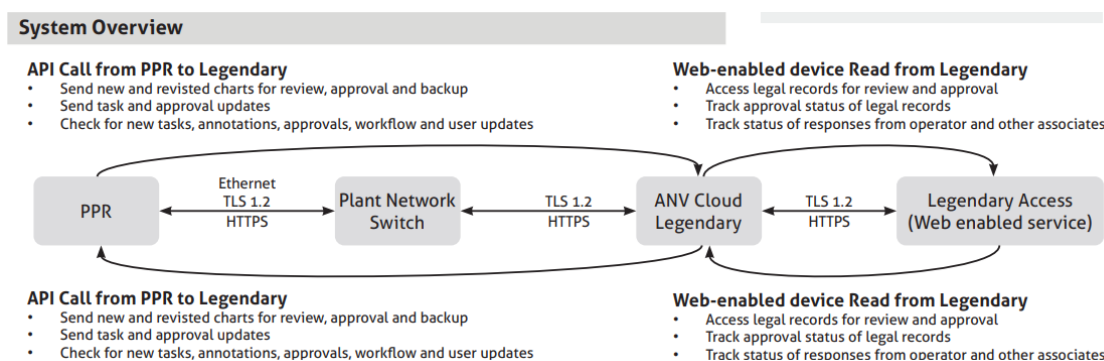

Figure 6: PPR Network Communication Overview

2.1.2 PPR Record Creation and Data Storage

Record Creation

To eliminate the possibility of missing or lost data the PPR was designed to always be recording data when the instrument is powered on. Although the PPR is continuously recording data it will periodically compile this data into a **static chart image** (Record) which can be reviewed and approved at the PPR or using Legendary™ software. The time period of each Record starts at the “Record Start Time” and continues for the “Time Period of Record” as defined in Section 5.4.1 of this manual.

Static Chart Image

The Records generated by PPR are static chart images and cannot be dynamically changed or manipulated during the review. Users are limited to zooming in and out and panning across these images. All record images are generated in the PPR even when annotations or approvals are added by an authorized user from the Legendary™ Software.

Record Revisions

When the record is created by the PPR as described above it will first be produced with the Revision at number 1 displayed on the bottom of the record. Each time the PPR reproduces an image for the same Time Period it will automatically increment the revision number displayed on the record to the next whole number. It is typical for PPR records to be above revision 1 because when they are approved the PPR will regenerate the image to include the approval information. Record revisions will also be increased when additional annotations are added to the time period of a record after the first Image was created for that time period.

Data Storage

PPR stores all process data, annotations, approval information based on time stamps at which they were recorded in an internal database on embedded Multi-Media Controller (eMMC). The data storage scheme is Write Once Read Many (WORM) as the PPR internal computer that writes this data will not write over data with the same time stamp. PPR Users cannot access the PPR internal database through the HMI or other means.

Data Backup

PPR syncs all Records to Legendary™ within 15 minutes of record creation, when the network connection is active. See Section 5.1.1 to ensure the PPR network connection is active. The records stored in Legendary™ are read only and cannot be modified by any user.

Additionally, data is backed up to the removable storage device, see additional information below.

Removable Storage

For redundancy, the PPR creates and maintains a copy of the latest revision of Record images on a removable storage device. In addition to the latest revision of record images, for applications with a Record Period that exceeds 24 hours, a daily chart is created by PPR and backed up to the removable storage device every 24 hours.

A microSD card located on the SOM (See Figure 26) is used for the removable storage, when required this device can be temporarily removed from the PPR allowing files to be transferred to a PC. These redundant files cannot be manually added to Legendary™ or approved by PPR Users outside of the PPR or Legendary™ Software.

Always Power off the PPR before installing or uninstalling the Removable microSD, failure to do so can damage the PPR.

2.1.3 PPR Record Layout

The records created by PPR are highly configurable and can be customized by a user who sets up the recorder to compile all the required information needed to prove a process was done into a single Record Image. Figure 7 below shows the standard elements that appear on a record generated by PPR.

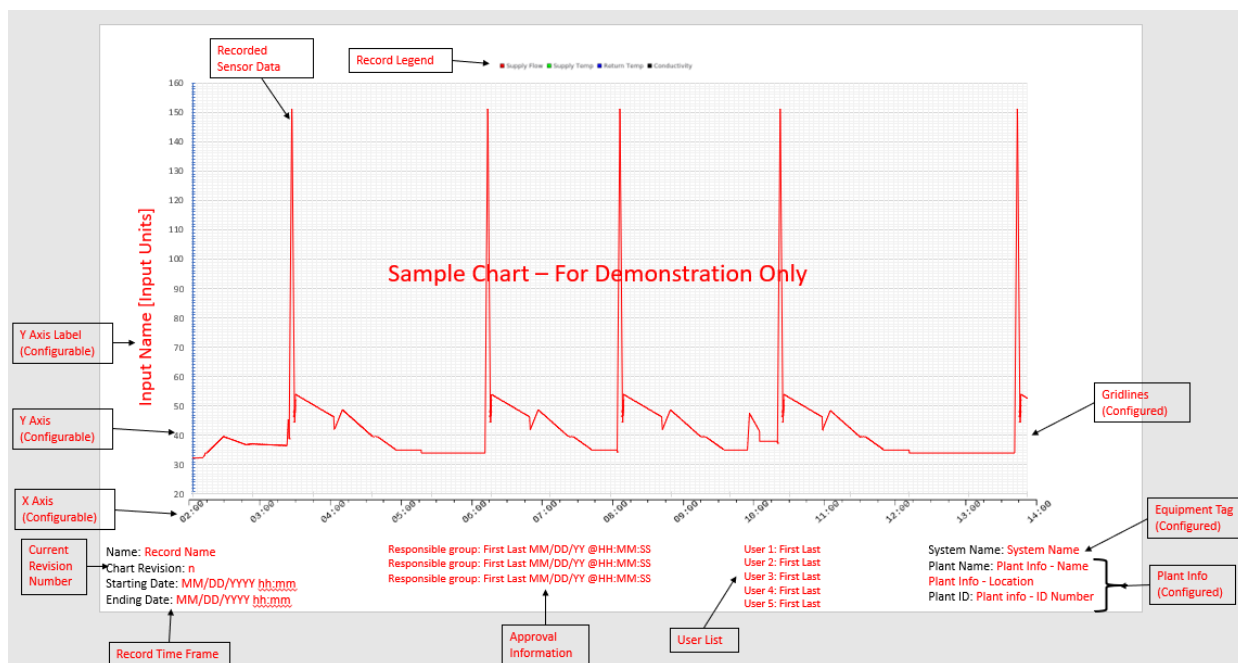

Figure 7: Elements of a PPR Record

Additional information on the common elements of all records is as follows;

- Legend – Automatically displayed above the chart area with all recorded data trendlines and colors

- Recorded Sensor Data – All inputs with Recording Enabled will automatically appear on each PPR Record.
 - Event Pens - Can be enabled in STLR and SFLR configuration only
 - Diversion Setpoint – Can be enabled in STLR Configuration only
- Y-Axis Label(s) - Fully configurable during the Recorder configuration
- Y-Axis – The Range, color, divisions are all configurable.
- Current Revision Number – Automatically incremented by PPR each time the Recorder generates a new Record.
- Record Time Frame - Fully configurable during the Recorder configuration
- Approval Information – Automatically added by PPR when the Record is approved through PPR or Legendary
 - space for a max 3 stage approval workflow
 - Approvals only added to the record after each stage of the approval has been completed.
 - Responsible group - Displays the name of the group responsible for each stage of the review.
 - If 2 two approvals from same responsible group are present the newer approval is shown on the PPR Record
- User List – Automatically added by PPR as each PPR or Legendary™ users logs in to the Recorder or adds an annotation(s) to the record
 - Users list generated and populated as each operator/user logs into the PPR or adds annotation or system info.
 - Maximum 5 users shown on charts.
 - If more than 5 Users authenticate on PPR/LD within the record period, the 6+ user(s) are omitted from this list.
 - Each user will only appear on this list once
 - List of users limited to the time period of record; Users who annotate after original record is created will not show up on this list.
- Plant Information - Fully configurable during the Recorder configuration
- System Name – Fully configurable during the Recorder configuration
- Gridlines – Fully configurable during the Recorder configuration

2.1.3.1 Viewing PPR Record Annotations

There are multiple elements to each annotation that appears on a PPR Record, those elements include;

- Users Initials – The Initials of the PPR User who was authenticated before the annotation was added. These Initials are required to be unique when users are configured in Legendary.
 - Initials “PPR” – Indicated that this is a System Generated Annotation
- Timestamp of the Annotation – The Time on the record the annotation is referring to. The point on the record is which an annotation is referring to is directly to the left of the user’s initials.

- In the “Add Notes” workflow where a user can an annotation to previously recorded data the cursor position is used to place the annotation at a specific time. This time becomes the Timestamp of the Annotation
- Time and Date added – The time and date in which the User added this information to the record. (Optional see Section 5.4.7)
 - Annotations added through the System information workflow are always added to the PPR record in real time.
 - System Generated Annotations are always added to the record in real time.
 - Annotations added from Legendary™ are always added to previously recorded data.
 - Annotations added through the Added Notes workflow are always added to previously recorded data.
- Annotation Text – The actual annotation the User or PPR added to the record.

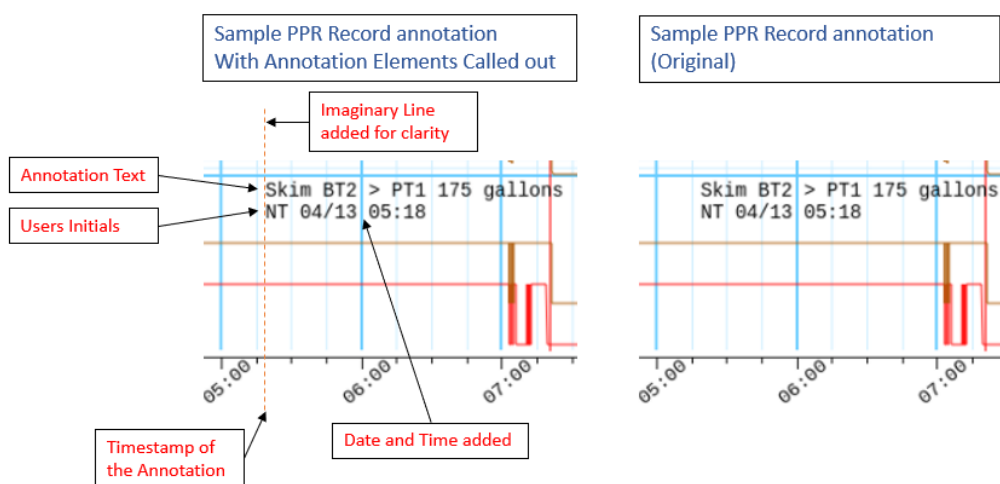

Figure 8: Elements of an Annotation

Figure 8 above shows an example of an annotations that appeared on a record created by PPR. In this example chart elements are as follows;

- Users Initials = NT
- Timestamp of the Annotation = 05:16
- Date and Time added = April 13th at 05:18
- Annotation Text = Skim BT2 > PT1 175 gallons

2.1.3.2 Viewing PPR STLR/SFLR Event Pens on Records

When PPR is configured for STLR/SFLR recording and control the event pen will automatically be recorded as explained in Section 5.4 of this manual. The STLR Event Pen scale is displayed on the left side of the graph while the SFLR Event Pen is displayed on the right, as seen in Figure 9 below.

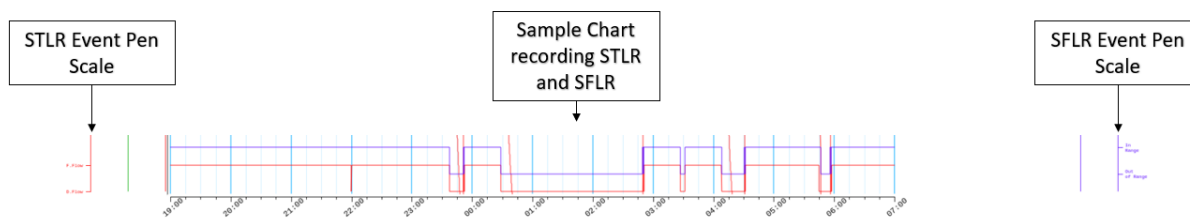

Figure 9: Event Pens on Records

2.1.4 PPR Record Approval Workflow

Following the record creation detailed above most customers use the PPR HMI or Legendary™ software to review and approve the records that have been created with authenticated users.

The Approval workflow includes the number of approval stages expected for each PPR record, responsible parties for the approval at each stage and the allowable timeframe for each approval stage. The approval workflow is configured at the equipment level in Legendary™ thus all PPR records from the same PPR will have the same approval workflow. Typical approval workflows are between one and three stages, Figure 10 below shows an example of a two-stage approval process.

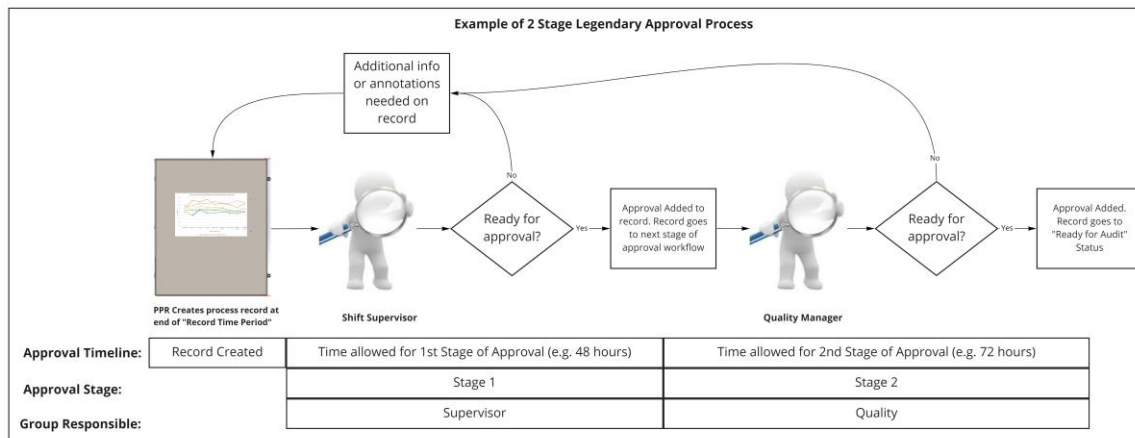

Figure 10: Sample Record Approval Workflow

User Management

All user management for PPR and Legendary™ is handled through the Legendary™ Software. Anderson-Negele requires an employee of the company, where PPR is installed, to be designated as the Legendary™ Software Plant Administrator. The Legendary™ Plant administrator is responsible for user management such as creating new users, inactivating former users and

password/PIN management. For additional information see the Legendary™ Operations Manual.

2.1.5 Run/Program Jumper and Sealing Covers

The PPR is equipped with a Run / Program Jumper (J9) located on the PPR motherboard. This jumper has two positions shown in Figure 11, which enable and disable certain functions as described below. Sealing Covers and Health Authority Seals can be used to ensure the Run / Program Jumper (J9) position changes are tamper evident. Additionally, the PPR electronically records all changes of the J9 position in the system activity log. The current position of the J9 Jumper is displayed on the top of the home screen with the icons shown in

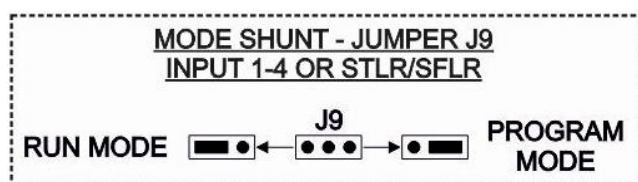

Figure 11: Run/Program Jumper Positions on Motherboard



Figure 12: J9 Jumper Position on HMI

The J9 jumper in the **Run Mode** results in the following conditions:

- Input 1-4 configuration is disabled
- Changes in Configure Recorder disabled (including STLR & SFLR Setpoints)
- Input Calibration is disabled
- Software updates are disabled
- STLR Relay Output can be active if other conditions are met, See Figure 14

The J9 jumper in the **Program Mode** results in the following conditions:

- Input 1-4 configuration is enabled
- Changes in Configure Recorder enabled (including STLR & SFLR Setpoints)
- Input Calibration is enabled
- Software updates are enabled
- STLR Relay Output is inactive See Figure 14

The J9 jumper position does not affect or inhibit the following:

- PPRs ability to record data or create records

- Annotations
- Network Configuration
- Output Configuration
- Process Alarm Configuration (Independent of STLR & SFLR Alarms)
- System Info/Annotation Configuration
- User Password Management

Sealing Covers

Multiple Sealing Covers can be used in conjunction with tamper evident seals to prevent users from accessing input wiring, STLR Relay Board, SFLR Relay Board, Run/Program Jumpers

Tamper evident Sealing Covers can be specified in the PPR order code at time of purchase, or they can be purchased from Anderson-Negele as spare parts.

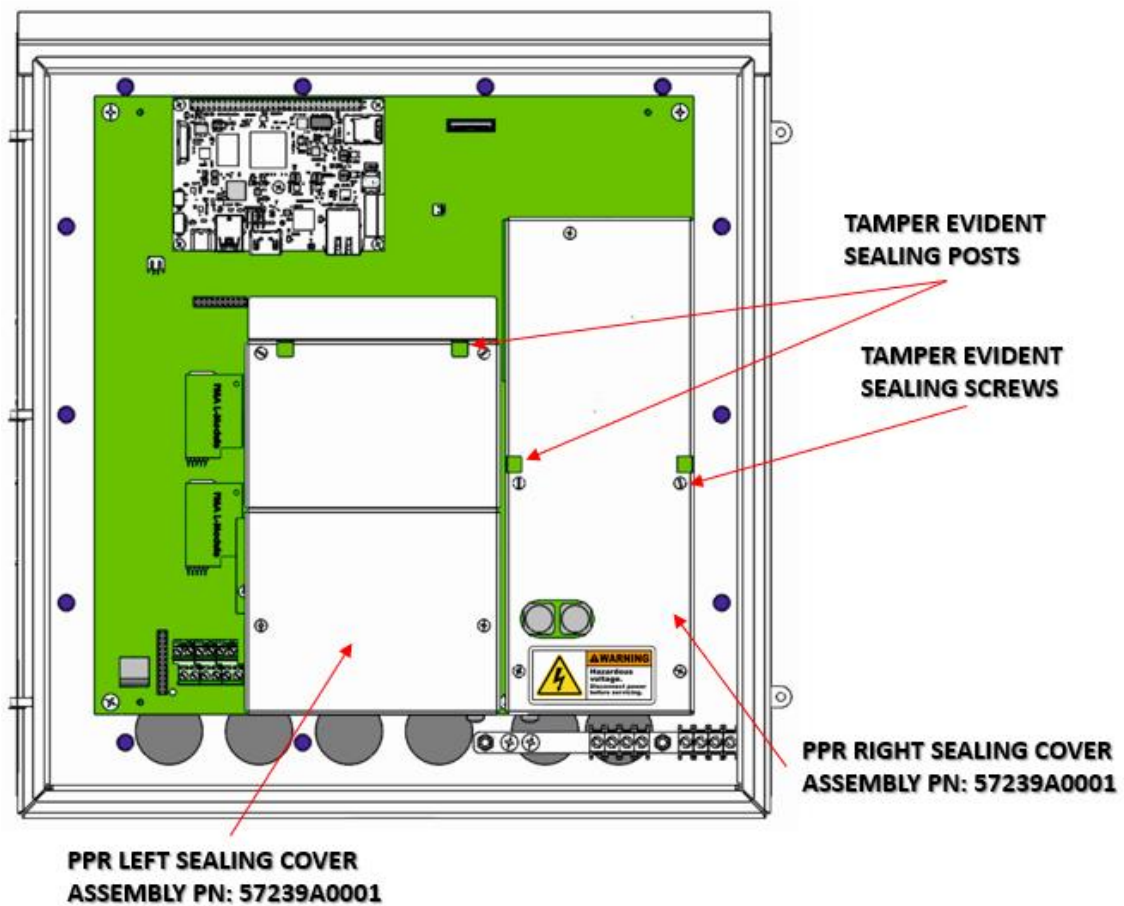

Figure 13: PPR Motherboard with Sealing Covers

2.1.6 STLR Hot Product Sensor (STLR Only)

The STLR Hot Product Sensor is a dual element, 1000ohm RTD. The Primary RTD supplies the recording - thermal limit signal input, with the Secondary RTD supplying a verification signal.

The Anderson-Negele "SB" sensor must be used for STLR applications. These sensors are available with a wide variety of sanitary connections featuring a 5-1/2" or 7-1/4" probe length. Provision for the Health Authority Seal on the stainless-steel conduit housing provides separate servicing of the probe, and ease of installation. Overall response characteristics allow for cable lengths of up to 500 feet.

2.1.7 STLR Recording and Control (STLR Only)

The STLR version of PPR provides all PMO required functions associated with recording and controlling a continuous pasteurization process. Including recording pasteurized product temperature, controlling/signaling the flow diversion valve (FDV.) and recording the Flow Diversion Valve position. Addition features allow for multiple diversion set-points, recording active setpoint, and recording peripheral pasteurization process such as cold product recording.

STLR set points provide up to 15 User selectable STLR Diversion Setpoints (STLR SP), the setpoint is equivalent to the cut-out temperature. Diversion set point values can only be changed when jumper J9 is in Program position. In addition to restricting access to the Run/Program shunt jumper, the Sealing Covers prevent modifications to circuit boards and input/output wiring connections.

Flow Diversion Device Position

Flow Diversion Device (commonly Flow Diversion Valve) position is indicated to the user in the input 2 position of the PPR HMI. Additionally this position can also be recorded and trended in the PPR Record (see Section 5.4.4) The event pen position is upward for STLR Forward Flow and downward for STLR Diverted Flow.

Selection of the current diversion set-point is accomplished via the *Change STLR Setpoint* button in the home screen.

STLR Relay Function

The STLR Relay functions as a real time controller output which activates the STLR Relay when STLR conditions are met. The primary condition for the STLR relay to become active is STLR Measured Input > STLR SP. Additional conditions to activate the STLR Relay are shown in Figure 14 below.

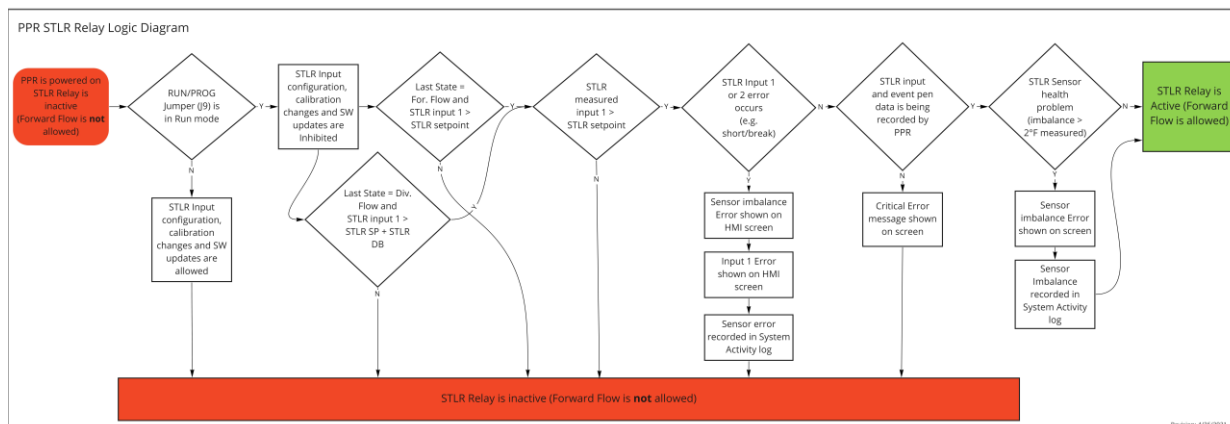

Figure 14: PPR STLR Relay Logic Diagram

Fail Safe Operation

The STLR Relay is designed to fail safe under various PPR or input error conditions as shown in Figure 14. Proper system wiring practices covered in Section 3.7 of this manual are required to ensure fail safe operation.

2.1.8 SFLR Recording and Control (SFLR Only)

SFLR Relay Function

The SFLR Relay functions as a real time controller output which activates the SFLR Relay when SFLR conditions are met. The primary condition for the SFLR relay to become active is Loss of Signal Alarm SP < SFLR Input < High Flow Alarm SP. Additional conditions to activate the SFLR Relay are shown in Figure 15 below.

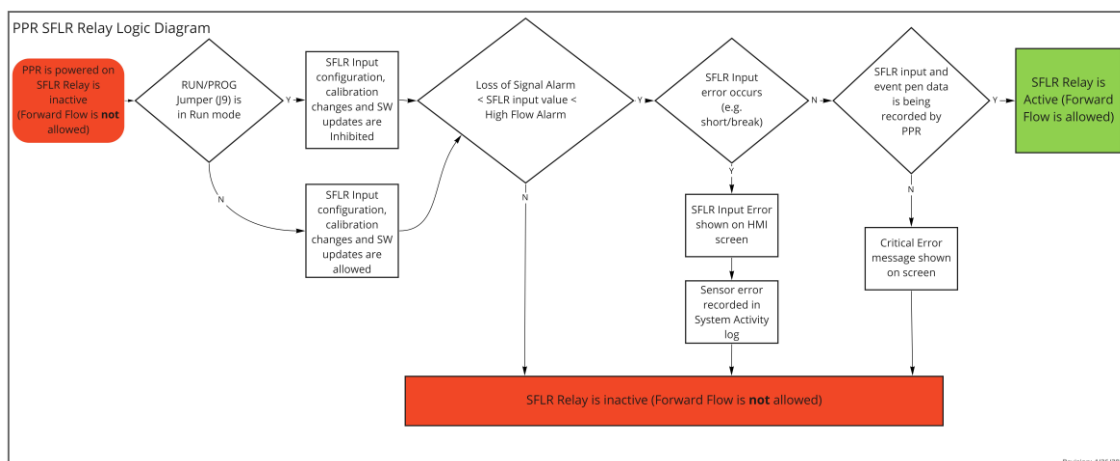

Figure 15: PPR SFLR Relay Logic Diagram

Fail Safe Operation

The SFLR Relay is designed to fail safe under various PPR or input error conditions as shown in Figure 15. Proper system wiring practices covered in Section 3.6.2 of this manual are required to ensure fail safe operation.

2.1.9 STLR Diagnostic Circuitry (STLR Only)

The PPR provides fail-safe operation via internal self-diagnostics of the STLR Input signals. The Primary RTD input signal (STLR Input 1) is continually referenced against the Secondary RTD signal (STLR Input 2). The difference between the calibrated measured inputs is indicated on the home screen of PPR as the Sensor Imbalance. If the imbalance is greater than 1°C or 2°F the system will record a sensor imbalance in the system activity log and display a warning message on the PPR HMI. If STLR Input 1 or STLR Input 2 measure a short or open circuit the STLR Relay output will be inactivated causing the system to divert. The STLR Relay output will remain inactive until the measured values are back in the expected range.

2.2 Unpacking

Remove the instrument from the shipping container and inspect for any damage due to shipment. If any damage is noticed due to transit, report and file a claim with the carrier. The model number and serial number are found on the label inside the case.



CAUTION: READ THIS MANUAL

[Attention : LISEZ CE MANUEL]

IT IS IMPORTANT TO READ THIS MANUAL BEFORE INSTALLING OR COMMISSIONING THE UNIT.

This serial number and Model number can be found on the PPR door label which is located on the inside of the PPR door. See Figure 16 below.

Serial Number (SN):

Each PPR receives a unique 7-digit serial number during the manufacturing process, in addition to the door label this serial number can be found in the version screen of PPR. The first two digits of the serial number represent a 2-digit year code corresponding to the year of manufacture e.g. SN:2112345 was manufactured in 2021.

Model Number:

The PPR is a modular platform recorder used in a variety of process recording applications. The model number is built using a matrix model numbering scheme, see Figure 17 below. The latest PPR model matrix can be found on the Anderson-Negele Website:

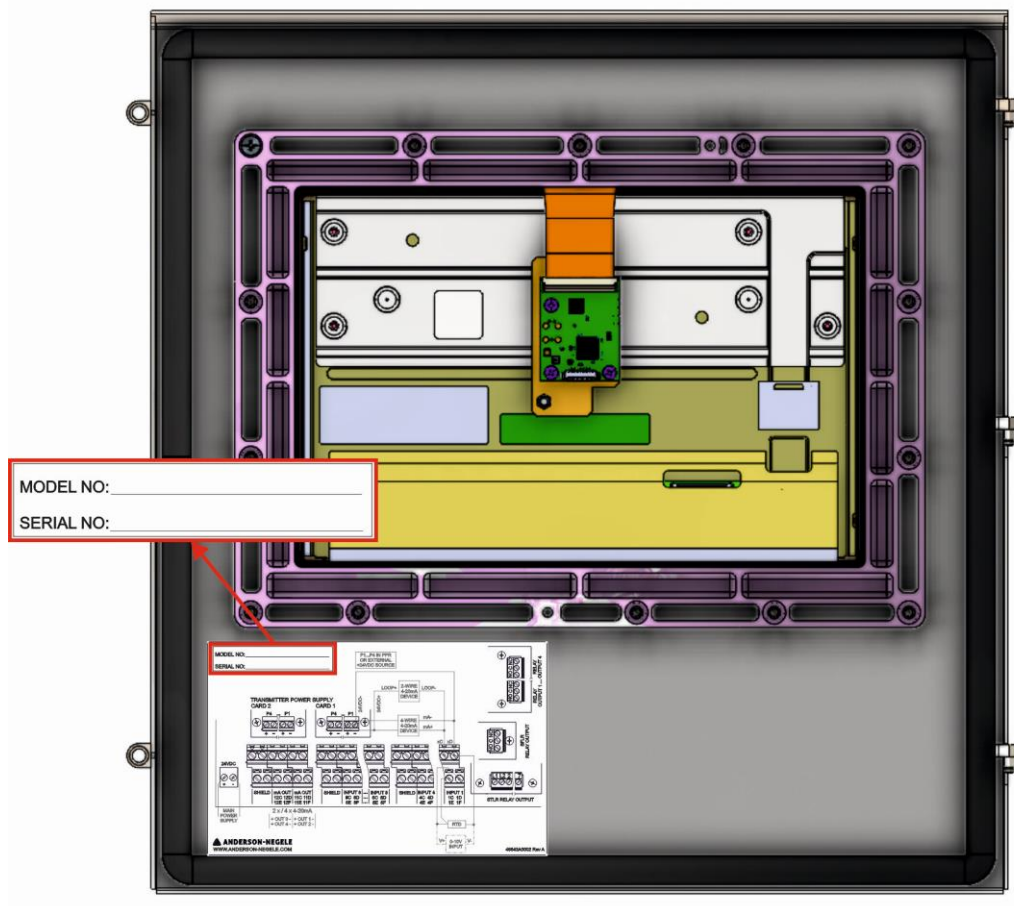

Figure 16: Door Label on Inside of PPR

2.3 Order Matrix/Model Number

See latest Anderson-Negele PPR Product brochure for the latest product Matrix

| Product code | | | | | | | | | | |
|--------------|--|---|----|---|----|----|----|---|---|-------|
| PPR | Paperless Process Recorder NOTE: Requires Annual Legendary™ Cloud Subscription | | | | | | | | | |
| | Safety Thermal Limit Recorder (STLR) | | | | | | | | | |
| XX | None NOTE: STLR options below include STLR relay and two input cards for dual PT1000 RTD STLR options require dual PT1000 sensor like SB probe (not included see page 5) | | | | | | | | | |
| TD | STLR with 24VDC relay | | | | | | | | | |
| T1 | STLR with 110VAC relay | | | | | | | | | |
| T2 | STLR with 220VAC relay | | | | | | | | | |
| | Safety Flow Limit Recorder (SFLR) | | | | | | | | | |
| X | None | | | | | | | | | |
| F | SFLR (only available with STLR option TD, T1, or T2; includes SFLR relay, one 4-20mA input card for SFLR and one additional universal input card) | | | | | | | | | |
| | Fixed | | | | | | | | | |
| XX | Fixed | | | | | | | | | |
| | Transmitter Power Supply | | | | | | | | | |
| X | None | | | | | | | | | |
| 4 | 4 Isolated 24VDC Supplies | | | | | | | | | |
| | Additional Analog Inputs (Transmitter power supply not included, see spare parts) | | | | | | | | | |
| | With STLR Option XX | | | | | | | | | |
| 4U | Four Inputs | | | | | | | | | |
| | With STLR Option TD, T1, or T2 | | | | | | | | | |
| XX | None | | | | | | | | | |
| | mA Outputs/Re-Transmission | | | | | | | | | |
| XX | None | | | | | | | | | |
| 2A | Two - Internally powered | | | | | | | | | |
| 4A | Four - Internally powered | | | | | | | | | |
| | Additional Relay Outputs | | | | | | | | | |
| XX | None | | | | | | | | | |
| 2R | Two | | | | | | | | | |
| 4R | Four | | | | | | | | | |
| | Enclosure | | | | | | | | | |
| W | Wall Mount, Bottom Wiring | | | | | | | | | |
| P | Panel Mount w/Enclosure, Back Wiring | | | | | | | | | |
| | Tamper Evident Sealing Covers | | | | | | | | | |
| X | No (Only available with STLR Option XX) | | | | | | | | | |
| S | Yes | | | | | | | | | |
| | Fixed | | | | | | | | | |
| XXXXX | XXXXX | | | | | | | | | |
| PPR | TD | F | XX | X | XX | 4A | 4R | W | S | XXXXX |

Figure 17: PPR Product Matrix (Version 50017 / 1.2 / 2022-06-20 / NA / RF)

2.4 Specifications

See latest Anderson-Negele PPR Product brochure for the current product specifications.

| Specification | | | |
|----------------------------|---|---|---|
| Inputs | Number of Inputs | Up to 4 | |
| | Current | 0-20mA, 4-20mA | |
| | Voltage | 0-25mV, 0-100mV, 0-1V, 0-10V, 1-10V | |
| | RTD | Pt100 or Pt1000, 2 or 3 wire | |
| | Scan Rate | 100ms | |
| | Recording Rate | 3 seconds | |
| | Recording Accuracy | +/- 0.3% of span | |
| Ambient Temperature Effect | +/- 0.005% of span per °F deviation from 77°F (0.01% / °C from 25 °C) | | |
| Outputs | mA Outputs | Up to 4; 0-20mA, 4-20mA | |
| | Relay Outputs | Up to 4; Mechanical SPDT, Normally Open or Closed | |
| | Digital Alarms | Contacts rated at 5 amps resistive at 115 VAC, 2.5 amps resistive at 230 VAC Up to 16 | |
| Backup Storage | Removable Storage | supplied with 32GB microSD card. Contains last 100 days of Record Images & 24 hour backup record images | |
| | Non-Removable Storage | 4 GB eMMC (Up to 7 years of raw data and annotations. Accessible only through HMI. Cannot be exported.) | |
| | Cloud Storage | Unlimited storage of all PPR created record images in Legendary™ | |
| Interface | Display | 10" 1280x800 Touchscreen display with chemically strengthened glass with shatterproof screen protector | |
| | Operating System | Embedded Linux | |
| Cloud | Network | Ethernet/RJ45 | |
| | Server | Rackspace | |
| | Destination Domain | https://clients.intellex.com, https://preprod-na.intellex.com and their subdomains | |
| | TCP and UDP Ports | HTTP(80), HTTPS(443), DNS(53), SSH(22) | |
| | Encryption | HTTPS / TLS 1.2 or above | |
| | Data Format | JSON | |
| | Sync frequency | 15 minutes | |
| IP Address | Dynamic or Static | | |
| Power | Voltage | 24-30VDC Max. Minimum 20V at PPR power supply terminals | |
| | Current | Max 2 amperes | |
| Enclosure | Mounting Option | Wall Mount / Surface Mount | Panel Mount (Through Panel) |
| | Material | Stainless Steel | Stainless Steel |
| | Conduit Openings | Qty. 6, 7/8" diameter, Located on bottom | Qty. 6, 7/8" diameter, Located on back |
| | Overall Dimensions | 14"W x 15"H x 3"D | 14"W x 15"H x 3"D |
| | Panel Depth | N/A | 1.25" |
| | Panel Cutout | N/A | 12.7"W x 12.7" H + 6 holes for wiring |
| | Front Panel Protrusion | N/A | 3" |
| | Water Ingress Rating | NEMA 4X | NEMA 4X |
| | Weight | 16 lbs. | 16 lbs. |
| | Vibration | 3 to 100 Hz @ 0.2g | 3 to 100 Hz @ 0.2g |
| | Accessories | Wall mount brackets and screws | Panel mounting bracket, gasket and nuts |
| Environment | Operating Temperature | 32-122°F | |
| | Humidity | 10 to 90% RH, non-condensing | |
| Approvals | Electrical | CE (Pending) | |
| | Water Ingress Rating | NEMA 4X | |
| Warranty | 2 Years | | |

Figure 18: PPR Product Specifications (Version 50017 / 1.1 / 2021-12-20 / NA / RF)

2.5 Warranty and Return Statement

These products are sold by Anderson-Negele under the warranties set forth in the following paragraphs. Such warranties are extended only with respect to a purchase of these products, as new merchandise, directly from Anderson-Negele or from an Anderson-Negele distributor, representative or reseller, and are extended only to the first buyer thereof who purchases them other than for the purpose of resale.

Warranty

These products are warranted to be free from functional defects in materials and workmanship at the time the products leave the Anderson-Negele factory and to conform at that time to the specifications set forth in the relevant Anderson-Negele instruction manual or manuals, sheet or sheets, for such products for a period of two years.

THERE ARE NO EXPRESSED OR IMPLIED WARRANTIES WHICH EXTEND BEYOND THE WARRANTIES HEREIN AND ABOVE SET FORTH. ANDERSON-NEGELE MAKES NO WARRANTY OF MERCHANTABILITY OR FITNESS FOR A PARTICULAR PURPOSE WITH RESPECT TO THE PRODUCTS.

Limitations

Anderson-Negele shall not be liable for any incidental damages, consequential damages, special damages, or any other damages, costs or expenses excepting only the cost or expense of repair or replacement as described above.

Products must be installed and maintained in accordance with Anderson-Negele instructions. Users are responsible for the suitability of the products to their application. There is no warranty against damage resulting from corrosion, misapplication, improper specifications, or other operating condition beyond our control. Claims against carriers for damage in transit must be filed by the buyer.

This warranty is void if the purchaser uses non-factory approved replacement parts and supplies or if the purchaser attempts to repair the product themselves or through a third party without Anderson-Negele authorization.

Returns

Anderson-Negele's sole and exclusive obligation and buyer's sole and exclusive remedy under the above warranty is limited to repairing or replacing (at Anderson-Negele's option), free of charge, the products which are reported in writing to Anderson-Negele at its main office indicated below. Anderson-Negele is to be advised of return requests during normal business hours and such returns are to include a statement of the observed deficiency. The buyer shall pre-pay shipping charges for products returned and Anderson-Negele or its representative shall pay for the return of the products to the buyer.

Approved returns should be sent to:

ANDERSON-NEGELE
ATTN: REPAIRS DEPARTMENT
150 Venture Blvd
Spartanburg, SC 29306 USA

3 Installation and Wiring

Read these instructions carefully before proceeding with installation and operation. Electrical code requirements and safety standards should be observed. Installation should be performed by qualified personnel only.

3.1 Mounting

The panel where the instrument will be mounted must provide rigid support for the approximately 16-pound PPR instrument. Adjacent instruments may be mounted within a minimum of 2 inches horizontally and 1 inch vertically, providing that proper panel support is supplied.

When the PPR is configured and ordered the mounting style is specified in the PPR product matrix as either Panel mount or Wall mount, the required hardware for installation will be included with the PPR order.

3.1.1 Panel Mounting

Figure 19 shows how the PPR can be installed in a Panel using the provided installation hardware. Figure 20 shows physical dimensions for a panel mounted instrument.

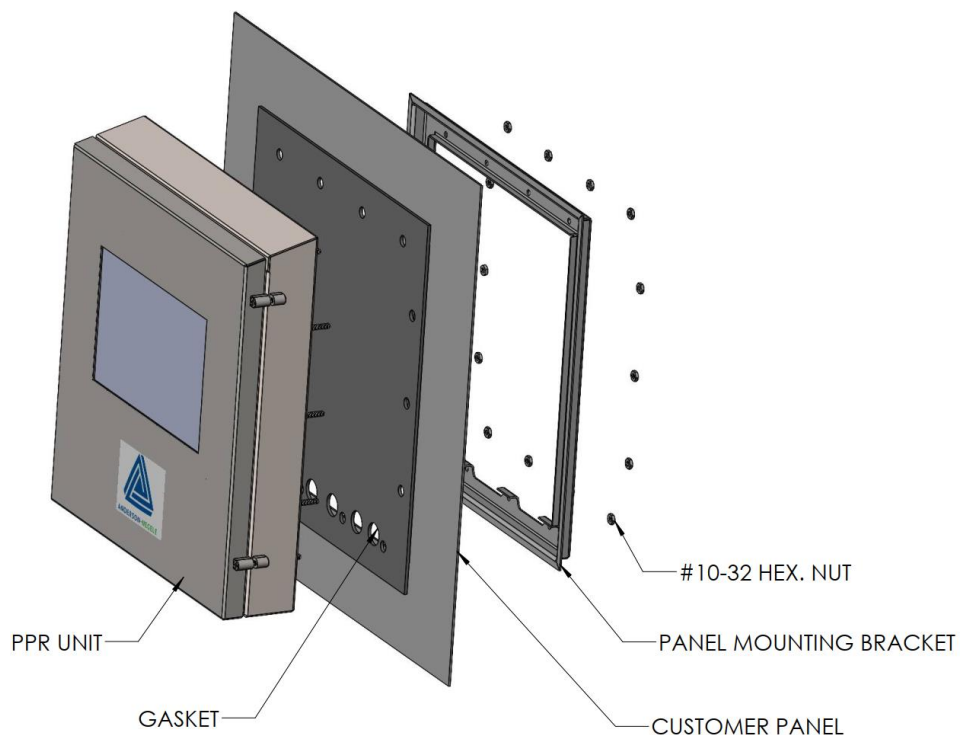

Figure 19: Panel Mount Assembly

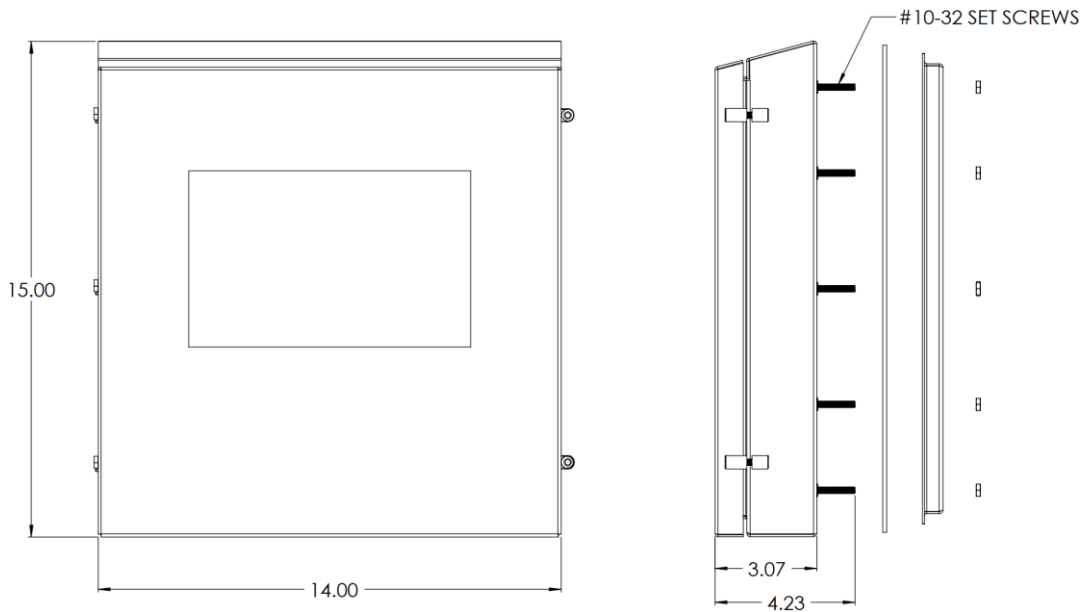

Figure 20: PPR Dimensions

Panel Mounting Hardware Required:

- (1) panel mounting bracket
- (14) #10-32, 1-1/2" long, 18-8 stainless steel set screws
- (14) #10-32, 18-8 stainless steel hex nuts

Installation Procedure

1. Pre-drill fourteen 1/4 dia. holes for mounting as seen in Figure 21 or use the drill template molded into the case after inserting the instrument into the panel.
2. Insert the threaded set screws into the holes in the back of the PPR
3. Insert the instrument in the panel opening. Firmly fasten the instrument to the panel using the mounting bracket, screws, and nuts.

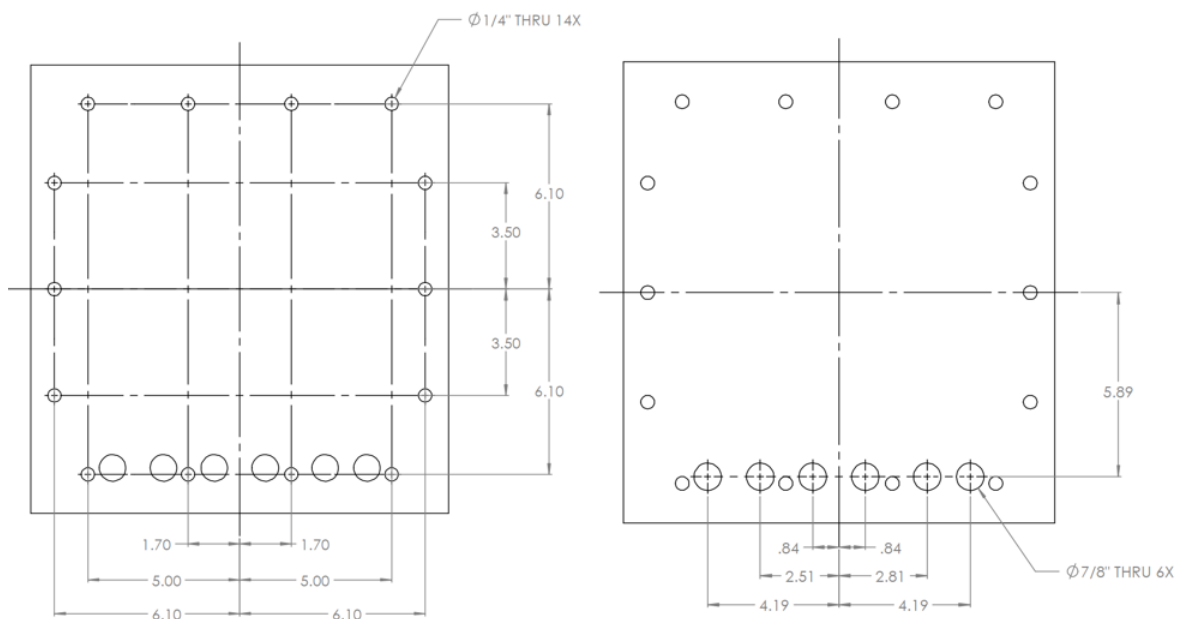

Figure 21: Hole Specification for Panel Mount

3.1.2 Surface/Wall Mounting

Figure 22 shows how the PPR can be installed against a wall using the provided installation hardware. Figure 23 shows physical dimensions for a wall mounted PPR enclosure.

Surface/Wall Mounting Hardware Required:

- (2) Stainless Steel mounting brackets
- (6) #10-32, ½" long, 18-8 stainless steel flat head screw
- (4) Screws to fasten PPR brackets into surface (Not included in PPR shipment)

Installation Procedure

1. Use (6) #10-32, ½" long screws to fasten the mounting brackets to the back of the PPR.
2. Position the PPR with mounting brackets installed against where the PPR will be installed.
3. Use the 4 exposed holes on the mounting brackets as a template to mark the position of customer supplied fasteners.
4. Pre-drill the marked holes if required.
5. Use customer provided fasteners to attach the PPR to the desired surface.

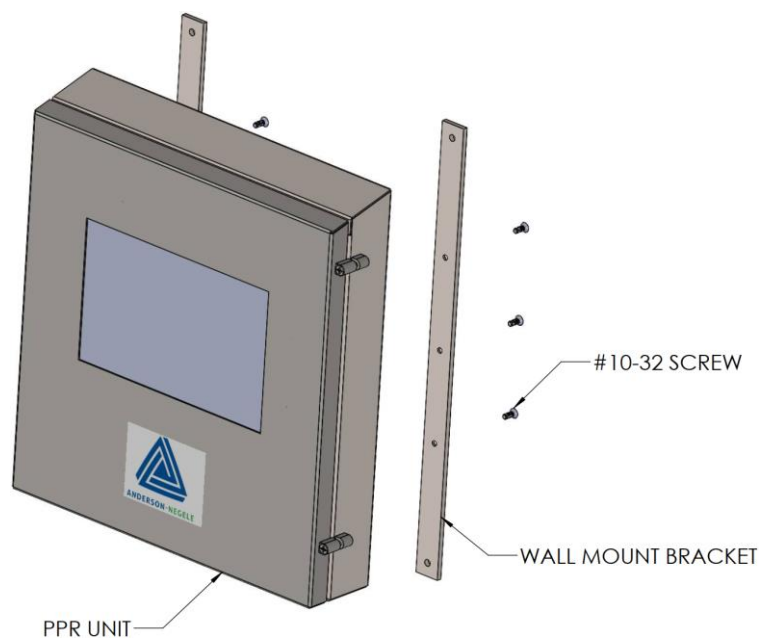

Figure 22: PPR Wall Mount Assembly

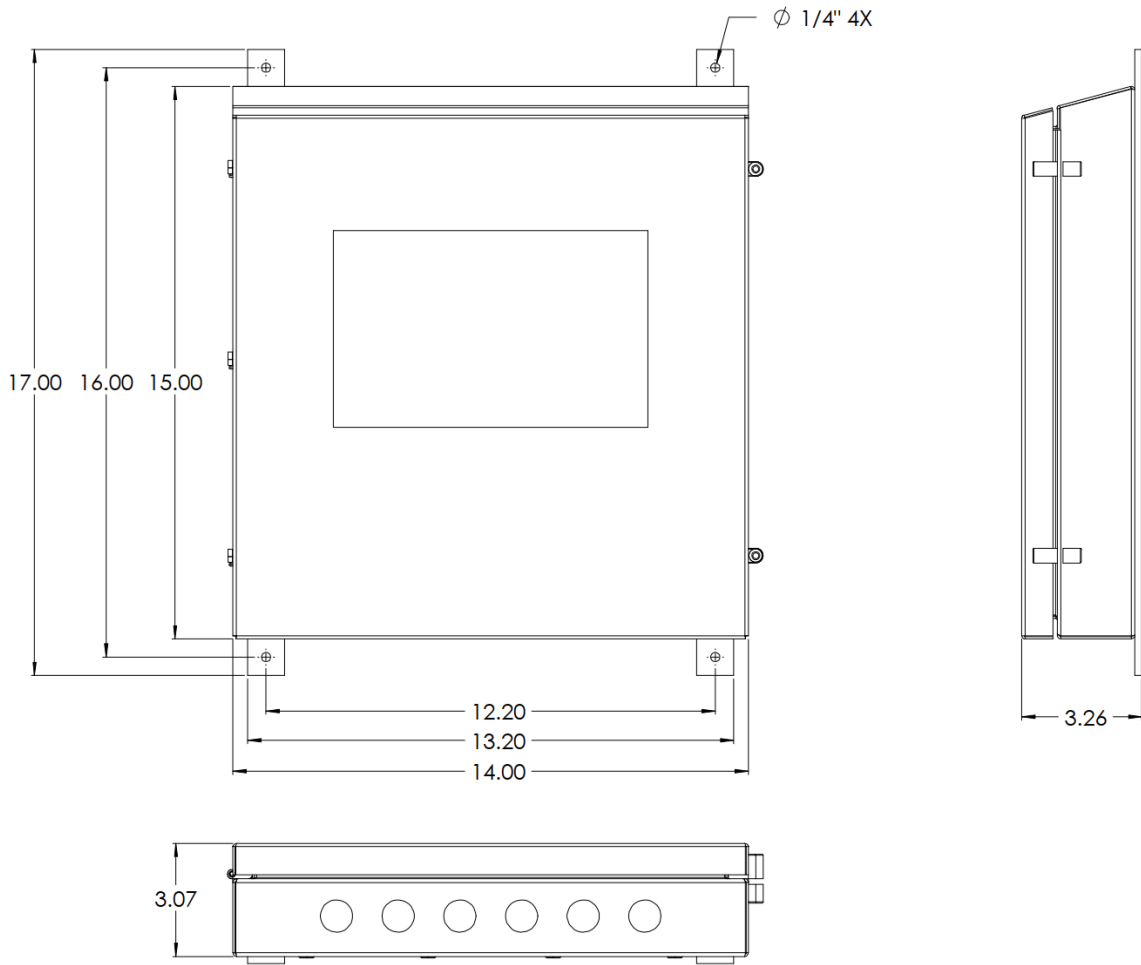

Figure 23: Wall Mount Dimensions

3.2 Preparation for Wiring

This product is in conformity with the protection requirements of Directive 2014/30/EU of the European Parliament and of the Council of 26 February 2014 on the harmonization of the laws of the Member States relating to electromagnetic compatibility. The factory cannot accept responsibility for any failure to satisfy the protection requirements resulting from a non-recommended modification of this product.

Electrical noise is a phenomenon typical of industrial environments. The following are guidelines that must be followed to minimize the effect of noise upon any instrumentation.

Installation Considerations

Listed below are some of the common sources of electrical noise in the industrial environment:

- Ignition Transformers
- Arc Welders
- Mechanical contact relay(s)
- Solenoids

Before using any instrument near the devices listed, the instructions below should be followed:

1. If the instrument is to be mounted in the same panel as any of the listed devices, separate them by the largest distance possible. For maximum electrical noise reduction, the noise generating devices should be mounted in a separate enclosure.
2. If possible, eliminate mechanical contact relay(s) and replace with solid state relays. If a mechanical relay being powered by an instrument output device cannot be replaced, a solid-state relay can be used to isolate the instrument.
3. A separate isolation transformer to feed only instrumentation should be considered. The transformer can isolate the instrument from noise found on the AC power input.
4. If the instrument is being installed on existing equipment, the wiring in the area should be checked to ensure that good practices have been followed.

Use of Shielded Cable

Shielded cable helps eliminate electrical noise being induced on the wires. All analog signals should be run with shielded cable. Connection lead length should be kept as short as possible, keeping the wires protected by the shielding. Use the shield terminals located in both the input and output terminal section of the PPR motherboard for termination. See Figure 24 below for shield terminal locations.

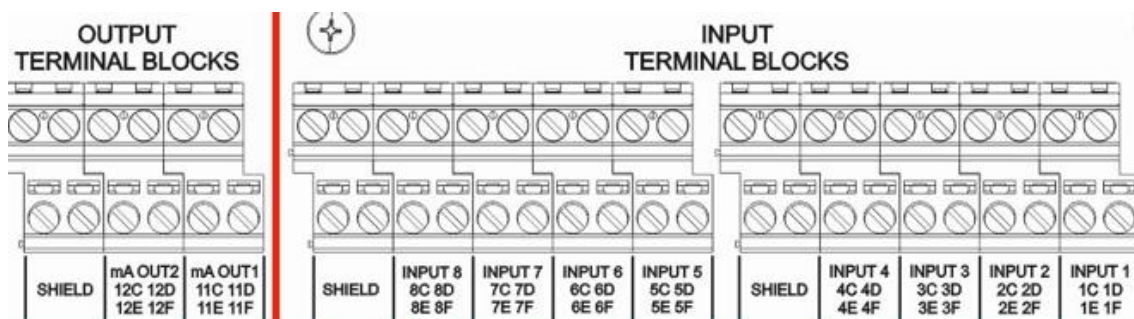

Figure 24: Shield Terminal Locations

Noise Suppression at the Source

Usually, when good wiring practices are followed, no further noise protection is necessary. Sometimes in severe electrical environments, the amount of noise is so great that it must be suppressed at the source. Many manufacturers of relays, contactors, etc. supply "surge suppressors" which mount on the noise source.

For those devices that do not have surge suppressors supplied, RC (resistance capacitance) networks and/or MOV (metal oxide varistors) may be added.

Inductive Coils - MOV's are recommended for transient suppression in inductive coils connected in parallel and as close as possible to the coil. See Figure 25. Additional protection may be provided by adding an RC network across the MOV.

Contacts - Arcing may occur across contacts when the contact opens and closes. This results in electrical noise as well as damage to the contacts. Connecting a RC network properly sized can eliminate this arc.

For circuits up to 3 amps, a combination of a 47-ohm resistor and a 0.1 microfarad capacitor (1000 volts) is recommended. For circuits from 3 to 5 amps, connect 2 of these in parallel. See Figure 25

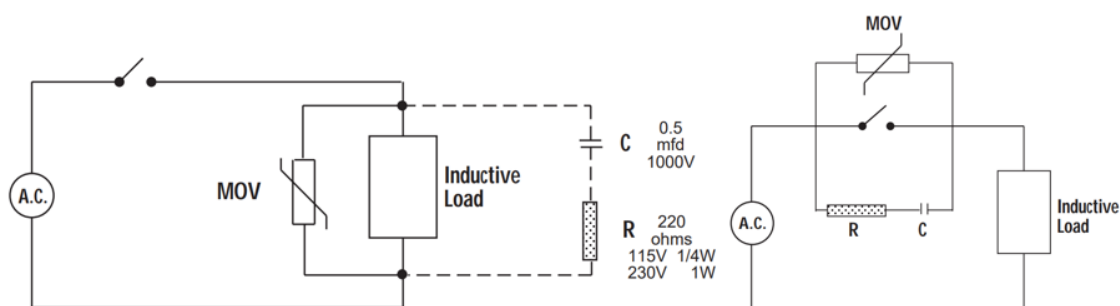

Figure 25: RC Network for Noise Suppression

Sensor Placement (RTD)

Two wire RTD's should be used only with lead/cable lengths less than 10 feet. If the temperature probe is to be subjected to corrosive or abrasive conditions, it should be protected by the appropriate thermowell. The probe should be positioned to reflect true process temperature:

- In liquid media - the most agitated area
- In air - the best circulated area

Conduit Openings

The instrument case has six conduit openings, located on the bottom of Surface mount enclosure or the Back of the Panel mount enclosure. To help minimize electrical noise that may adversely affect the operation of the instrument, do not run analog input and output wiring through the same conduit entry as relay or power supply connections.

Wire size and Torque

All wiring connections are typically made to the PPR instrument at the time of installation. Connections should be made at the I/O terminal blocks shown later in the Wiring section of this manual. A maximum of one 14-gauge, copper conductors should be installed to each terminal. The recommended torque for all connectors in the unit is 85oz-ins.

3.3 Circuit Board and Terminal Identification/Locations

The PPR is a modular platform, depending on the matrix code that is ordered some circuit boards may be included or excluded from the assembly. Figure 26 below shows the locations of circuit boards and wiring terminal for a fully loaded 8 input PPR.

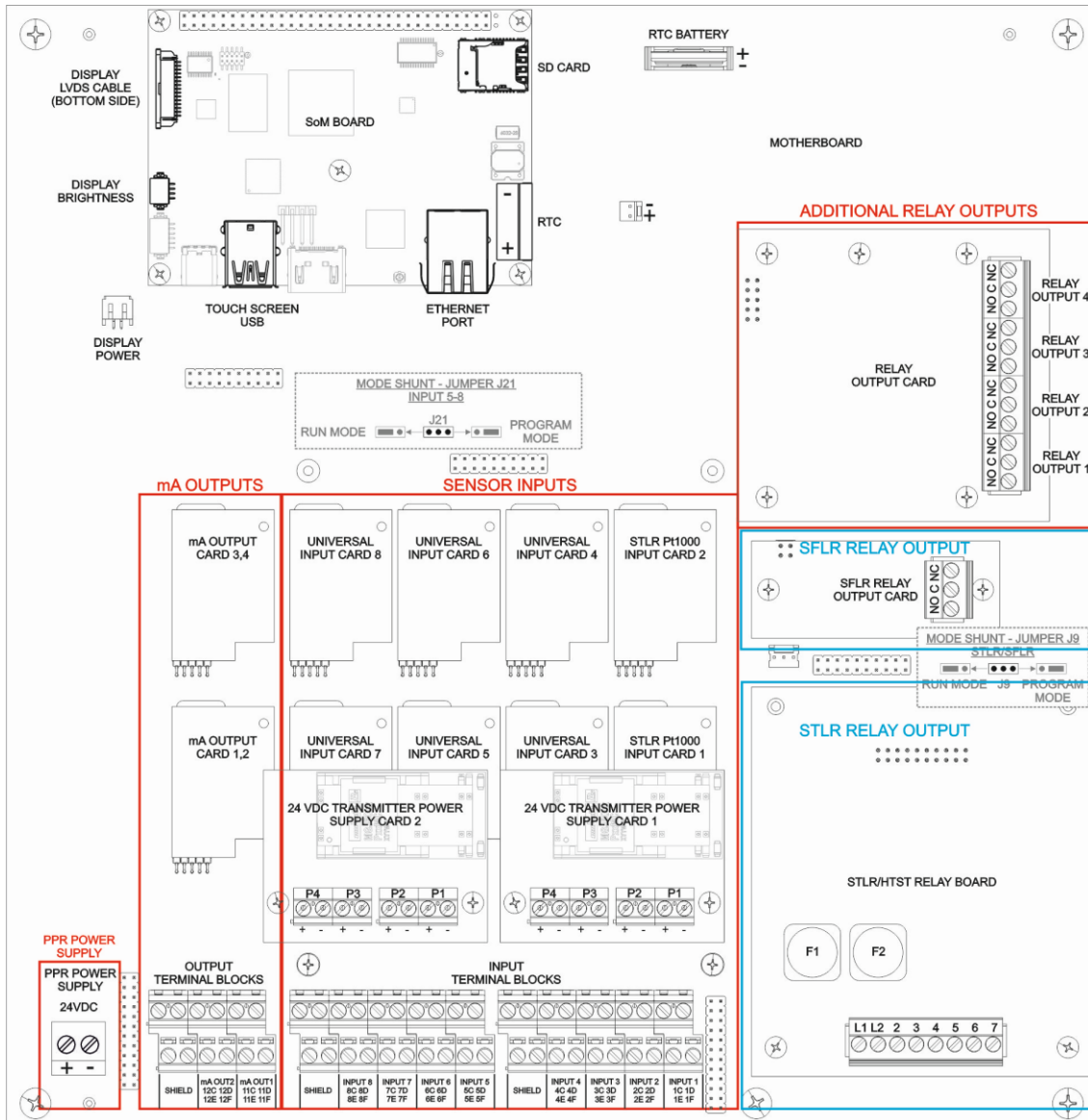

Figure 26: PPR Circuit Board Locations

Note

Boards present will be determined by PPR model ordered. Boards shown with blue box above are specific to STLR and SFLR applications only.

3.4 Wiring Connections – System Power

Nominal 24 VDC power is recommended to power PPR. If the power supply is connected to other devices as well, ensure that at least 20 VDC is measured at the PPR power supply terminals. 30 VDC Maximum should be used to power PPR. PPR consumes a maximum of 48 watts.

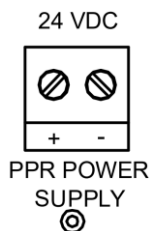

Figure 27: System Power Wiring

The use of an Uninterrupted Power supply (UPS) may be required in certain regulated applications such as Grade A milk pasteurization. For such applications a minimum of a 0.66 amp-hour UPS is required to ensure a PPR with 4 inputs can continue to record and control data for 20 minutes.

Disconnect Requirements:

A dedicated disconnecting device (e.g., circuit breaker) must be provided for the proper installation of the PPR. If independent circuits are used for power input and main relay outputs, individual disconnects are required. Disconnects must meet the following minimum requirements:

- Located in close proximity to the PPR
- Easily accessible to the operator
- Appropriately marked as the disconnect for the PPR and associated circuit
- Sized appropriately to the requirements of the protected circuit (See Specifications)

3.5 Wiring Connections – Inputs

PPR can measure up to 8 inputs, each of those inputs can be configured to measure mA input, RTD input or a voltage input. See Section 5.3 of this manual for Input configuration information.

If an input card module is replaced in the field, the PPR user must resave the Input configuration associated with the Input module that was replace.

Note:

All input cards on non-STLR PPR are configured for mA input by default.

STLR Only

Input 1 and Input 2 on STLR version PPR will have special input card modules dedicated for measurement of Pt1000 RTD. These input card modules cannot be configured for other input types.

SFLR Only

Input 3 on STLR version PPR will be dedicated for measurement of SFLR mA input. It cannot be configured for other input types.

3.5.1 mA Input

Each universal input card module can be configured to measure either 0-20 mA or 4-20 mA. Milli-amp inputs can be used in conjunction with the optional PPR transmitter power Supply board, or the loop can be externally powered from another source.

Note:

There is no sensor break detection for zero based current inputs. example: 0-20mA range

SFLR Only

Input 3 on STLr version PPR will be dedicated for measurement of SFLR mA input. It cannot be configured for other input types.

Figure 28 below shows how to connect a mA input to the desired PPR input channel. In this figure x = the Input number.

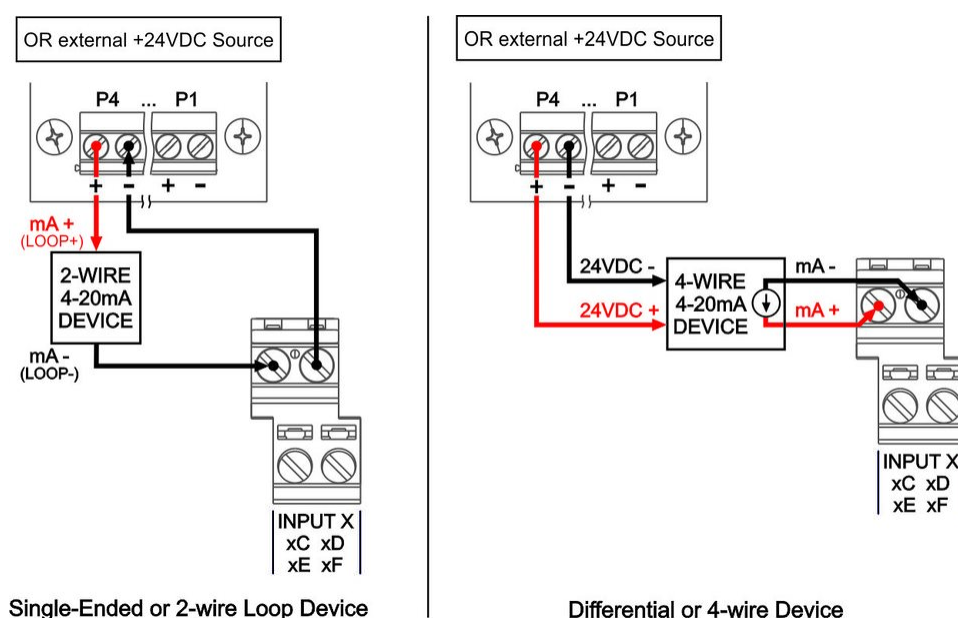

Figure 28: mA Input Wiring Connections

Process to connect single-ended mA input, where a 2-wire transmitter is powered by the PPR:

- connect the positive terminal of the transmitter (loop+ or mA+) to the positive terminal (+) of one of the transmitter power supplies P1 through P4 (Requires transmitter power supplies to be installed in PPR)
- connect the negative terminal of the transmitter (loop- or mA-) to xC
- connect a jumper between xD and the negative terminal (-) of the transmitter power supply

Process to connect single-ended mA input, where a 2-wire transmitter is powered by an external source:

- connect the positive terminal of the transmitter (loop+ or mA+) to the positive terminal (+) of the external power supply

- connect the negative terminal of the transmitter (loop- or mA-) to xC
- connect a jumper between xD and the negative terminal (-) of the external power supply

Process to connect differential wiring sensor input, where a 4-wire transmitter is being wired:

- connect the positive terminal of mA output from the transmitter to xC
- connect the negative terminal of mA output from the transmitter to xD
- transmitter can be powered up using PPR transmitter power supplies P1 through P4 or by using an external power source

3.5.1.1 Transmitter Power Supply (TPS)

When purchased as a spare part, up to two transmitter power supply assembly(s) (PN: 57221A0001) can be installed above the Input Terminal Blocks in a PPR to gain four isolated transmitter power supplies per card, as seen in Figure 29.

Nominal voltage output is 24VDC, power output is 1W on P1-P3 and 3W on P4.

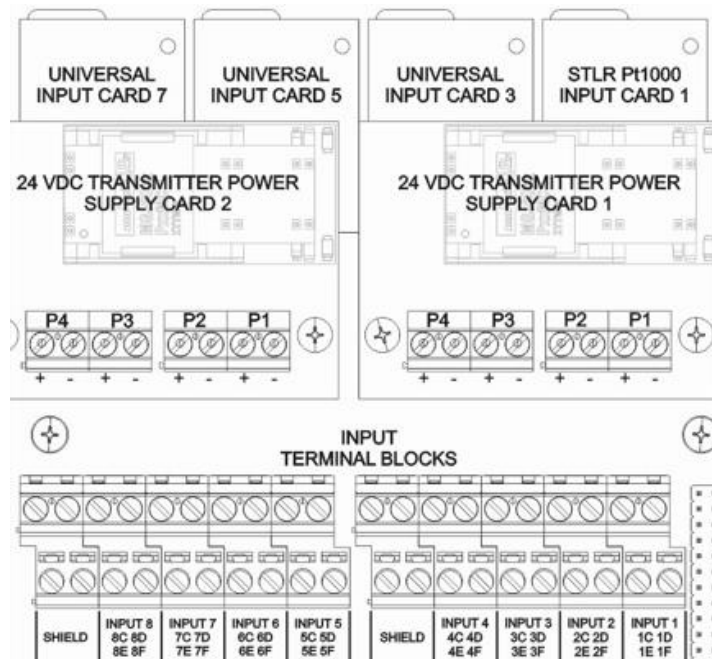

Figure 29: Optional Transmitter Power Supply Card

3.5.2 100Ω RTD Input - General

Each universal input card module can be configured to measure a 2 or 3 wire Pt100 RTD input with .00385 coefficient DIN (43760/IEC 751)

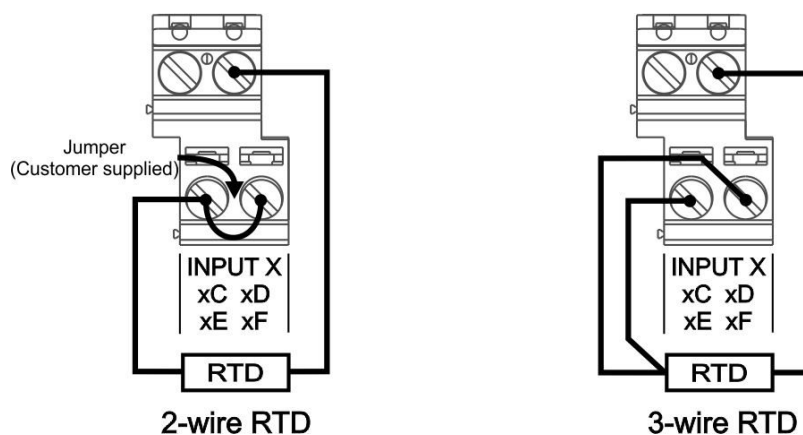

Figure 30: RTD Input Wiring Connections

Note:

- Input 1 and Input 2 on STLR version PPR will have a special card dedicated for measurement of Pt1000 RTD. They cannot be configured for other input types, see Section 3.5.3 for 1000 Ω inputs.

Process to connect a 2-wire RTD input:

- Connect signal wire to xD
- Connect common legs to xE
- Connect a jumper between terminals xE and xF

Process to connect 3-wire RTD input:

- Connect signal wire to xD
- Connect common legs to xE and xF

3.5.3 1000 Ω RTD Input – STLR Only

Input 1 and Input 2 on STLR version of PPR will have special R-Module Input cards dedicated for measurement of Pt1000 RTD. These input card modules cannot be configured for any other input types.

Note:

- The STLR RTD “SB” probe is provided with dual removable plugs and a specified length of six conductor shielded cable. If wires are removed for installation purposes, they must be re-wired properly.

Additional Note: Anderson does not recommend splicing of analog signal cable. The possibility will exist for corrosion, leading to intermittent connection or loss of signal. If cable length is insufficient, it is recommended that a new, longer, cable be installed between PPR and SB sensor.

- Vibration Dampener - DO NOT DISCARD: A small black rubber puck was shipped with the “SB” STLR Sensor. It is inside the conduit housing of the sensor and must be removed for wiring. This puck prevents terminal blocks from coming loose in high vibration applications. Always re-install this vibration dampener upon completion of probe SB wiring.
- Once all wiring has been completed, a Health Authority Seal must be placed from the cap (hole provided) around the seal-tight grommet. This will prevent unauthorized entry into the Hot Product Probe.

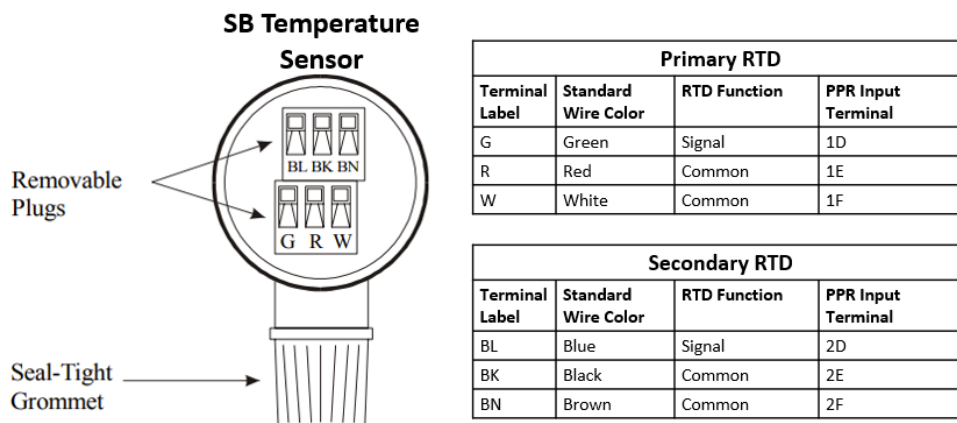

Figure 31: STLR SB RTD Probe Wiring

Process to connect 3-wire RTD input:

- Connect signal wire to xD
- Connect common legs to xE and xF
- Repeat this process for Inputs 1 and 2

3.5.4 Voltage Input

Each universal input card module can be configured to measure various voltage ranges e.g. 0-10V, 2-10V or 0-1500mV input.

Process to connect voltage input:

- Connect the positive terminal of the input to xF
- Connect the negative terminal of the input to xD.

Process to connect Single-ended wiring, where a 2-wire transmitter is powered by the PPR:

- Connect the positive terminal (+) of the voltage source to xD
- Connect the negative terminal (-) of the voltage source to xF

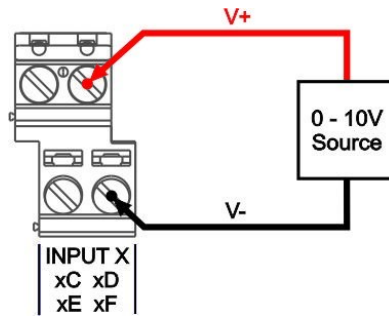

Figure 32: Voltage Input Wiring

Note:

There is no sensor break detection for zero based voltage inputs. example: 0-10V, 0-1500mV

3.5.5 Sensor Break and Error Detection

Sensor break and out-of-range conditions are determined and handled by the software. When either occurs, the software will record the input as either Upper Range Value, Lower Range Value or "Sensor Break" based on input configuration. See section 5.4.1 for additional information and to configure sensor break behavior.

3.6 Wiring Connections - Outputs

Relay output(s), if configured may be assigned to process alarms. See Section 5.7 for additional information on Alarm configuration.

Current mA output(s), if configured, may be assigned to any analog input value. See Section 5.6 for additional information on mA Output configuration.

Figure 33 below shows the locations of output circuit boards and wiring terminal for a fully loaded 8 input PPR

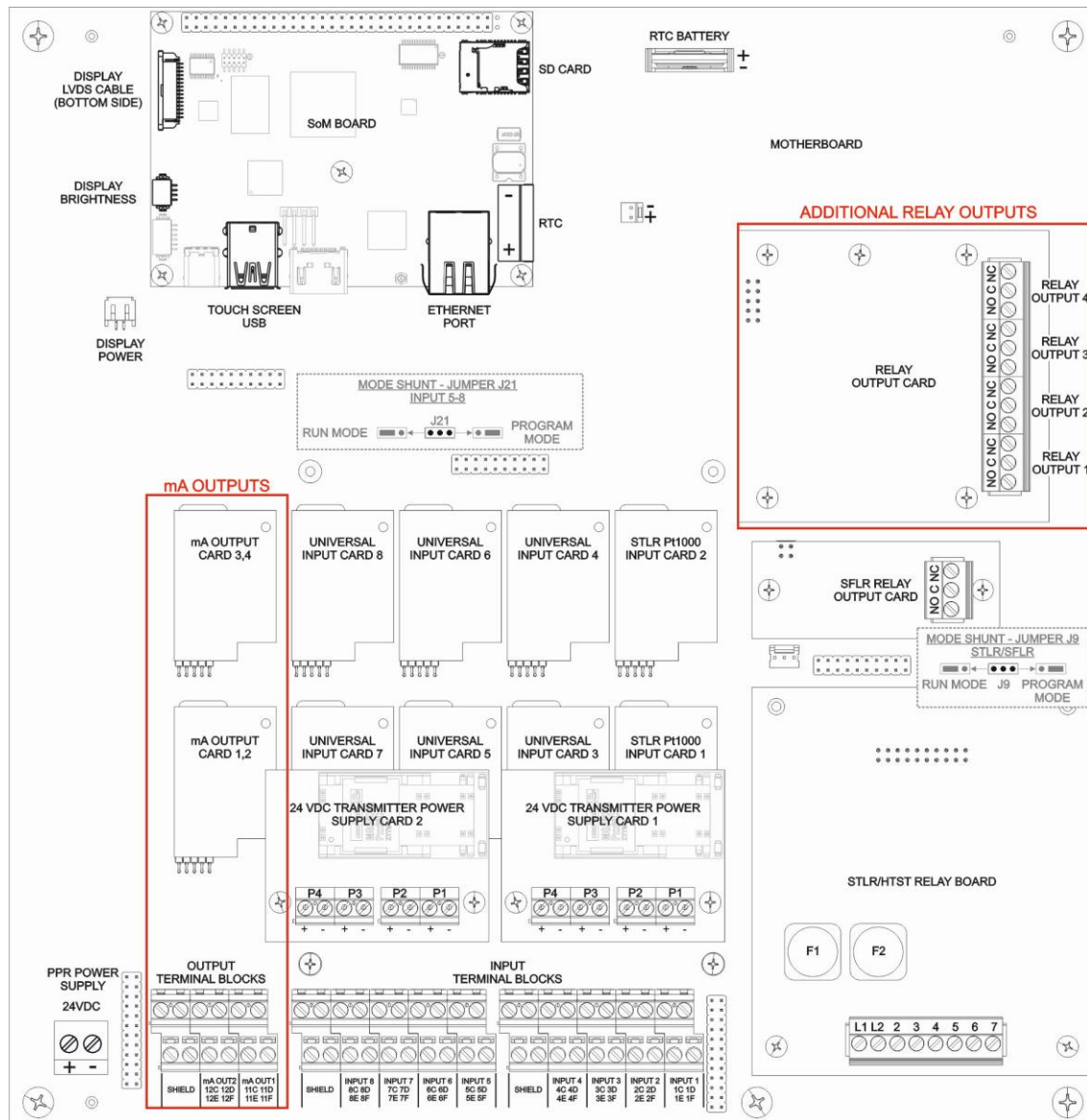

Figure 33: mA and Relay Output sections

3.6.1 Relay Output – General

When properly equipped the PPR can support up to 4 SPDT relay outputs. See Section 5.7 of this manual for Alarm configuration that drives relay outputs.

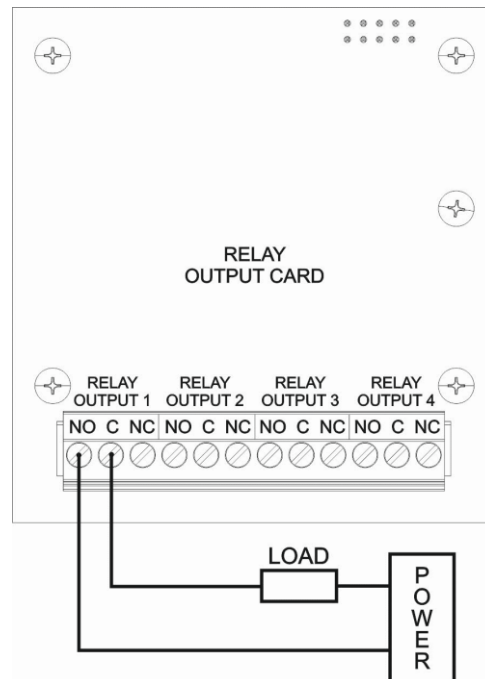

Figure 34: Relay Output Wiring



WARNING
High Voltage

3.6.2 SFLR Relay Output – SFLR Only

The SFLR version of PPR is equipped with the dedicated relay output for SFLR alarm. See Section 5.4.3 for configuration of SFLR relay output including setpoints for “Loss of Signal” and “High Flow Limit” Alarms. The SFLR Relay terminals must be wired to a PLC or other controlling device that will divert the FDD when the SFLR Relay state is inactive, which results in the no continuity between C and NO terminals.

Process to connect SFLR Alarm Relay:

- Wire to Common (C) and Normally Open (NO) SFLR relay terminals for failsafe operation
- When this relay is active based on the SFLR alarm control function, the relay terminals (C) and Normally Open (NO) gain continuity through the mechanical relay.

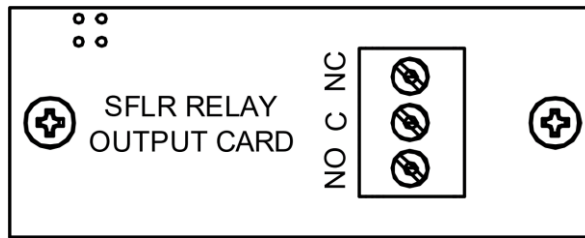

Figure 35: SFLR Relay Output Wiring



WARNING
High Voltage

3.6.3 Current Output

When properly equipped the PPR can support up to 4 internally powered mA outputs. Each output channel can be configured for 0...20 mA or 4...20 mA output. See Section 5.6 of this manual for additional information regarding configuration of mA outputs.

Note:

- All mA outputs are internally powered by PPR. They must be used in conjunction with passive or sink input instruments.

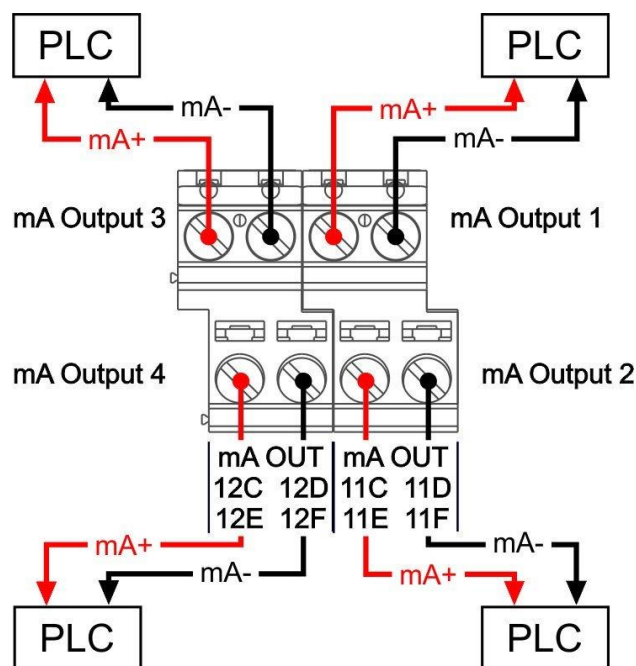

Figure 36: mA Output Wiring

Process to Connect mA Output to Odd channel numbers – Applicable to Outputs 1 and 3:

- connect the negative terminal of the mA output to xC
- connect the positive terminal of the mA output to xD

Process to Connect mA Output to even channel numbers – Applicable to Outputs 2 and 4:

- connect the negative terminal of the mA output to xF
- connect the positive terminal of the mA output to xE

Where “x” represents the output channel number as seen in Figure 36 above.

3.7 STLR Relay Board – STLR Only

On the STLR version PPR, wiring to the legal pasteurization controls (FDV, Differential Pressure Switch, etc.) is accomplished on the STLR Relay Termination Board. This board contains the STLR relay output which sends the control signal to FDD or customer’s legal PLC (Terminal 6) as well as the microswitch input terminals to read the state of the FDD (Terminals 4 and 7). The I/O terminal strip wiring utilizes the conventional STLR/HTST numbering system common to other paper recorders for ease of setup.

Input Voltage and Fuses

The STLR Relay Board must have input power supply voltage on Terminals L1 & L2. There are three versions of the STLR Relay Board, each of which supports a different input voltage. Part Number (PN) 57214A0001 supports 220VAC, PN:57214A0002 supports 110VAC, while 57214A0003 Supports 24 VDC. See Figure 37 for F1 and F2 Fuse requirements for the STLR Relay Board.

Terminal Numbers and Description

- L1 – Line voltage (110-220VAC) or 24VDC+
- L2 – Line voltage (110-220VAC) or 24VDC-
- 2 – Common to flow diversion solenoid, Timing pump starter, Booster pump starter
- 3 – Flow Diversion Valve Microswitch Input common
- 4 – Flow Diversion Valve Microswitch Input (Diverted Position)
- 5 – Timing Pump Starter control voltage signal
- 6 – STLR Relay Active Signal to Flow Diversion Device (FDD)
- 7 – Flow Diversion Valve Microswitch Input (Forward Flow Position)

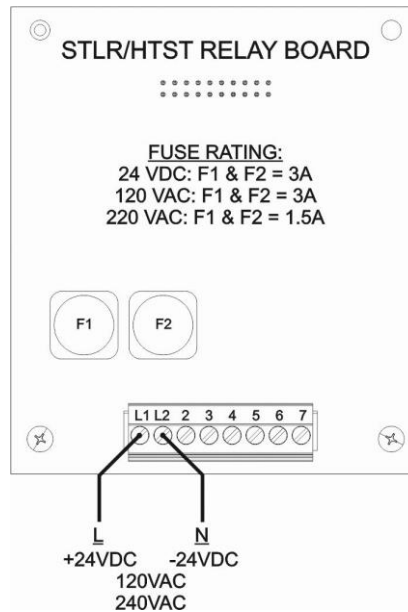

Figure 37: STLR Relay Board Control Wiring

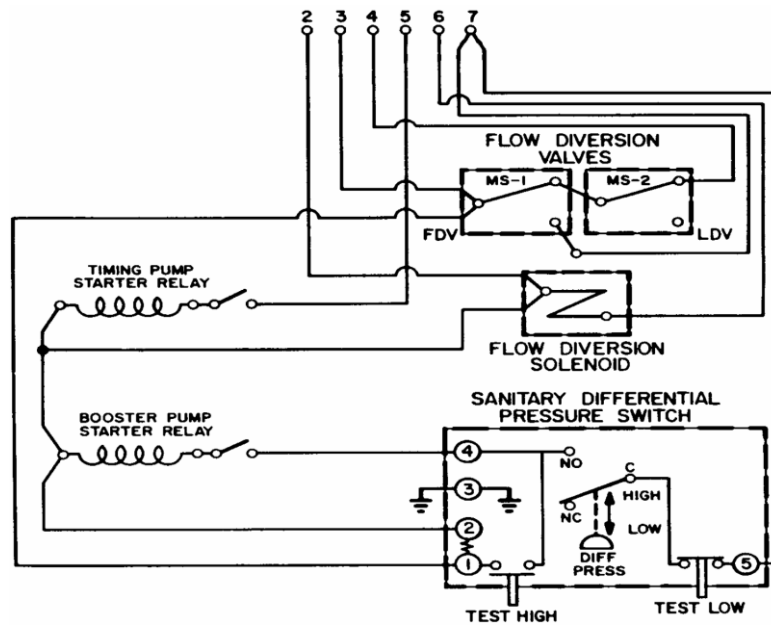

Figure 38: Legal Pasteurization Control Wiring (Divert)



WARNING
 High Voltage

3.8 Network Wiring

PPR needs to be connected to internet via ethernet to communicate with Legendary™. The location of the ethernet port in the main board SOM is shown below. Transmission Control Protocol/Internet Protocol (TCP/IP) can be setup for a static IP or a dynamic IP address. To view or reconfigure your network settings see section 5.1

Note:

- It is a common practice for Network Security/ IT Teams to restrict the internet access of IoT devices by using firewall rules. When firewall restrictions are applicable ensure that the PPR can access the Legendary™ Endpoint URL through the firewall. See Section 5.1.1 for additional information.
- Contact your network or IT administrator for network configuration settings, if needed.

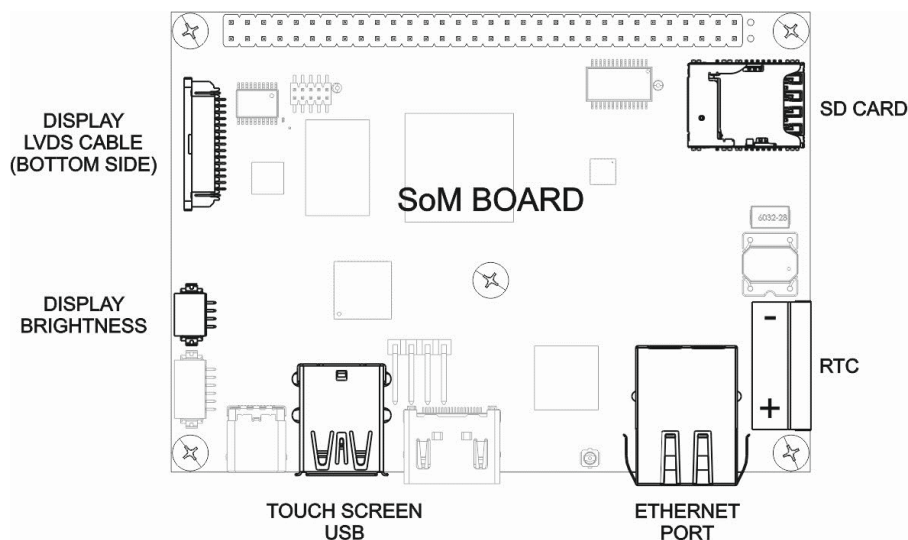

Figure 39: Network Wiring

4 Basics of Recorder Operation

4.1 Commissioning PPR

4.1.1 PPR Configuration

Once all input and output wiring are completed, PPR can be configured through the PPR and following steps shown in Figure 40.

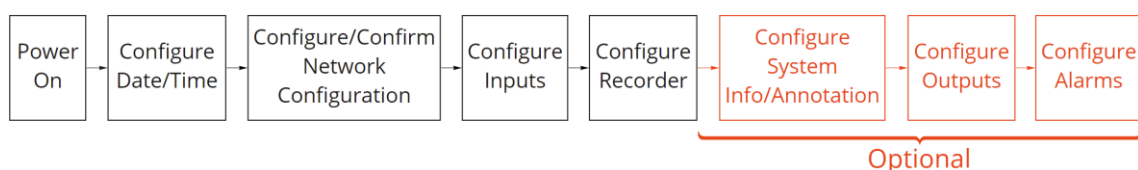

Figure 40: Commissioning - PPR Configuration

| Step | Action | Action Summary | Manual Section |
|------|----------------------------------|--|----------------|
| 1 | Power On | Apply 24VDC to main supply terminals | 3.43.4 |
| 2 | Configure Network | Menu->Network Configuration Set to DHCP or static IP. Contact plant IT if any issue. | 5.1 |
| 3 | Configure Date/Time | Menu->Date/Time Set time zone, date, and time format | 5.2 |
| 4 | Configure Inputs | Menu->Input Configuration Set input name, type, measurement range etc. | 5.3 |
| 5 | Configure Recorder | Menu->Recorder Configuration Set #records, record creation time and frequency, plant information, major/minor divisions of chart etc. | 5.4 |
| 6 | Configure System Info/Annotation | Menu->System Info/ Configuration Set system info header and add/edit/remove items Add/edit/remove pre-populated annotations | 0 |
| 7 | Configure Outputs | Menu->Output Configuration Set input association, output scale, output on error etc. | 5.6 |
| 8 | Configure Alarms | Menu->Alarm Configuration Set alarm name, type, setpoints, error state, relay association etc. | 5.7 |

4.1.2 Legendary™ Connection

Once PPR is fully configured connection with Legendary™ cloud software can be validated by following steps shown in Figure 41.

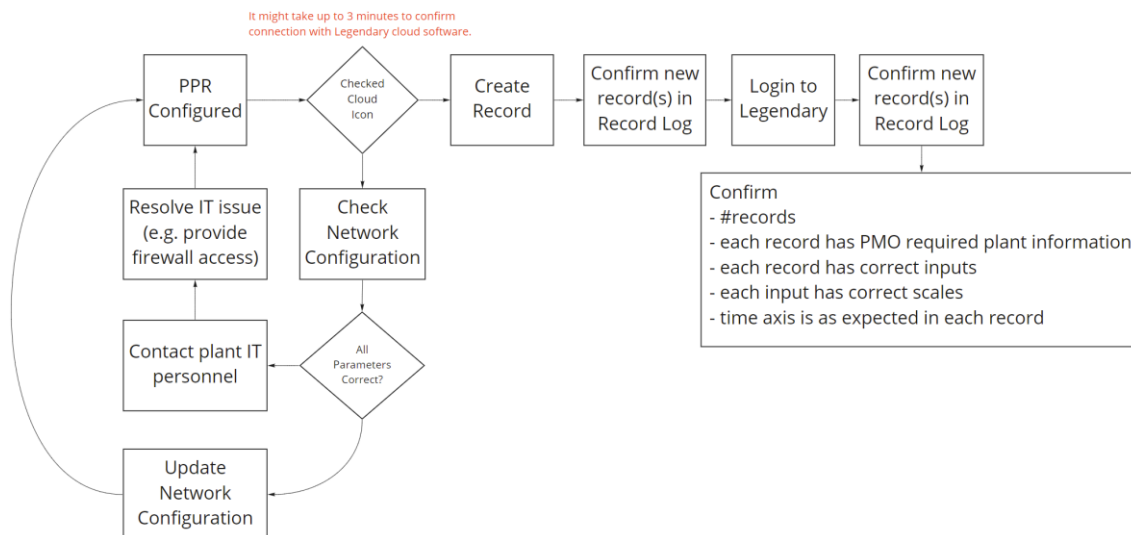

Figure 41: Commissioning Legendary™ Connection

| Step | Action | Action Details | Manual Section |
|------|---|--|-----------------------|
| 1 | Confirm Internet/Legendary™ Connection | Cloud icon should be checked | 0 |
| 2 | Confirm Record Creation in PPR | View Chart->Create Record View record in Record Log | 4.4.4.1 |
| 3 | Confirm Record is uploaded to Legendary | Login to Legendary View record in Record Log | See Legendary™ Manual |
| 4 | Confirm digital charts – inputs, scales, plant information etc. | Digital chart in Legendary™ record Confirm chart has all and only the configured input(s), correct plant information, each input has correct scale, time-axis is as expected etc. | See Legendary™ Manual |

4.2 Startup procedure

When power is applied to the PPR, the home screen will be displayed within 25 seconds. When the home screen is displayed on the HMI the PPR is now actively recording data.

4.3 Common Screens

4.3.1 Navigation Bar

The Navigation Bar at the top of the PPR HMI includes common action buttons and shortcuts to allow the PPR user to navigate the device. Figure 2.1 shows the home screen Navigation bar, the actions for each button are described below.



Figure 2.1: Home Screen Navigation Bar

- Menu – Go to main Menu
- Record Log - View log of records created on PPR
- Tasks – View tasks created by other users
- J9 JUMPER Position – Indicates the current position of the J9 Run/Prog Jumper
- View Chart – Go to HMI chart view displaying last 30 minutes of recorded data
- Cloud Connectivity – Current status of PPR to Legendary™ connection
- “Test Tag” – is the configured Equipment tag
- Time and date – Are always displayed in top right corner of the PPR HMI

On other PPR screens some additional buttons that may be displayed are;

- Add Notes – Allows User to add notes to previously recorded data points
- Back – brings PPR user to previous screen
- Unlock – Allows user to change configuration or calibration settings
- Reset – When a menu is unlocked this button will default the updated settings back to the state at which it was previously saved
- Save – Allows user to save changes in configuration or calibration settings
 - Run/Program jumper position may inhibit this action
 - Users credentials may limit this action

4.3.2 Home Screen

The home screen includes 4 main sections of information: Navigation Bar, System Info Fields, Process Measurements, and IP information. Figure 42 below shows how these sections appear to the PPR user.

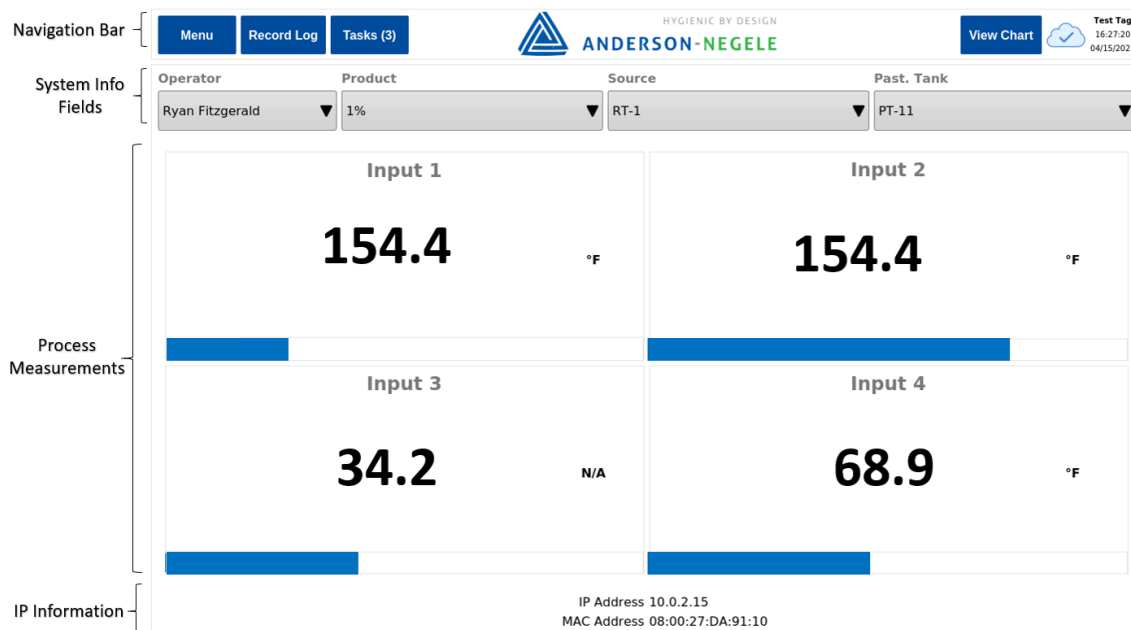

Figure 42: Home Screen Information Sections

System Information (info) Fields: These fields allow the user to quickly add annotations to the PPR record in real time. The System Info Name for each System Info field and the items that appear in the drop-down list are fully configurable on PPR. See section 0 of this manual for more information.

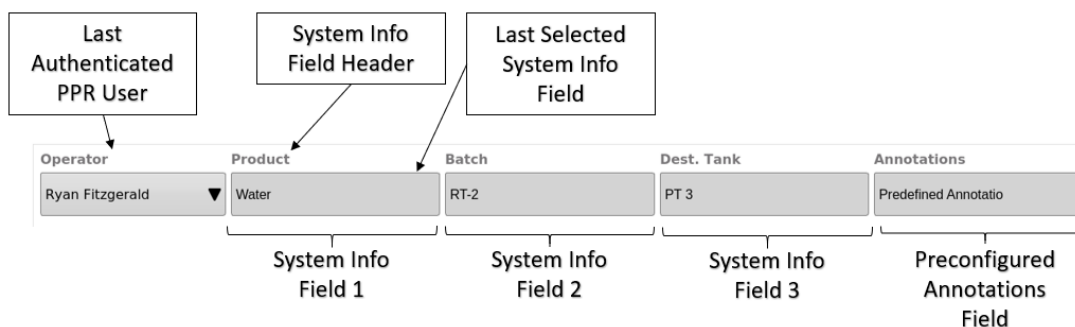

Figure 43: Home Screen System Info Fields

- Operator – Allows operator to sign-in or sign-out, changing this will require authentication and create an annotation on the record
 - The last authenticated user is always displayed in this field
 - The last authenticated user will always be preselected during the authentication workflow.

Process Measurements: The Process measurements section of the home screen is divided into sections depending on the number of available Inputs. Shown below is an

example of a 4 input PPR home screen where the process measurement section is divided into 4 equal quadrants. Each quadrant is automatically associated with a PPR input channel. The PPR will continuously update the numerical process measurement values on the home screen as well as a bar graph indicating the current value with reference to the input range. Each input must first be configured for the application to ensure that the data displayed in the Process Measurement fields are scaled correctly. See section 5.3 of this manual for more information.

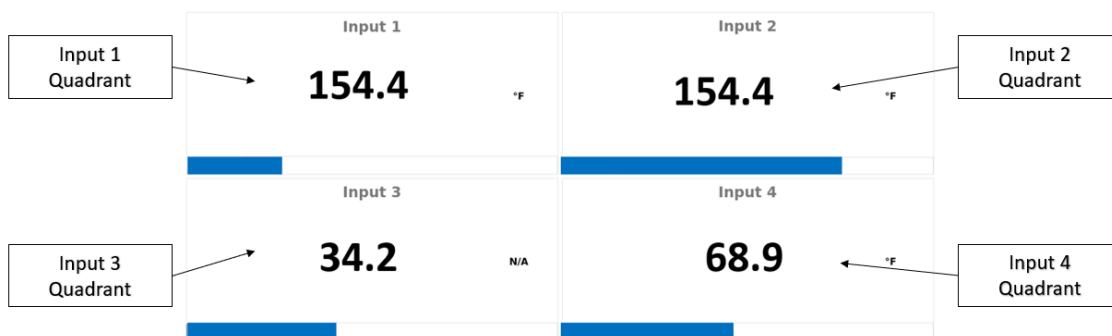

Figure 44: Process Measurement Section of Home Screen

Each input section contains the following information which are specific to the configuration of that input channel.

- Input Name – The configured Display Name
- Current process measurement – The scaled process measurement
- Display Units – Configured display units
- Bar Graph - This is a relative bar graph indicating the relationship between the Current input measurement, the lower input range and upper input range.

STLR Only: When PPR is configured for STLR applications the home screen space typically reserved for Inputs 1 and 2 will automatically be updated to display as shown in Figure 45 below.

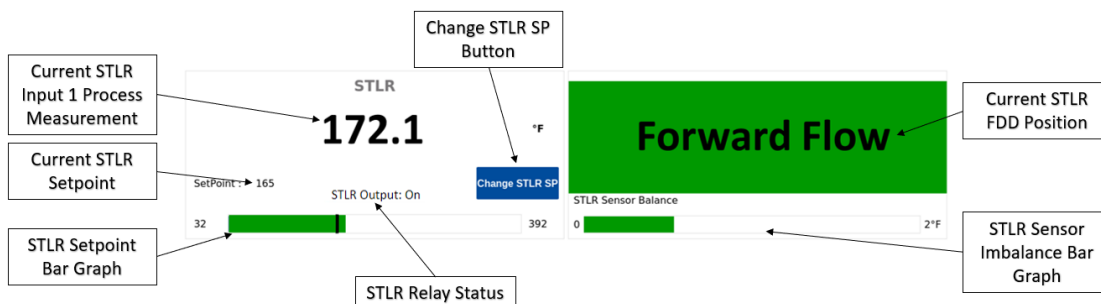

Figure 45: STLR Application Home Screen

- *Change STLR SP* Button – Allows PPR User to change the Current STLR Set Point (SP)

- Current STLR Setpoint – STLR Relay will be inactive below this temperature
- STLR Setpoint Bar Graph – This is a relative bar graph indicating the relationship between the Current STLR Input 1 Measurement and the Current STLR Setpoint.
 - The temperature scale of the bar graph is shown to the left and right of the graph.
 - The black vertical line on the bar graph represents the current STLR Setpoint.
 - Green color: Indicates that the Current STLR Input 1 Measurement is above the Current STLR Setpoint
 - Red Color: Indicates that the Current STLR Input 1 Measurement is below the Current STLR Setpoint
- STLR Relay Status – The status of the STLR Relay output
 - On – Relay is active
 - Off – Relay is inactive
- Current STLR FDD Position – Visual indication of the Flow Diversion Device (FDD) position. This information is measured by the STLR Relay board. Possible states include;
 - Diverted Flow – Displayed in Red, caused by L1 voltage measured on Terminal 4
 - Forward Flow – Displayed in Green, caused by L1 voltage measured on Terminal 7
 - Position Not detected – Displayed in gray, caused by L1 voltage measured on neither Terminal 4 nor 7
 - Valve Position Error – Displayed in gray, caused by L1 voltage measured on both Terminal 4 and 7
- STLR Sensor Imbalance Bar Graph – Displays the measured difference between STLR Input 1 and STLR Input 2
 - Fixed scale of 0°F - 2°F or 0°C - 1°C based on STLR Input Type.
 - Color: Green if imbalance is < maximum bar graph value, Red if imbalance > maximum bar graph value
 - Shows full imbalance if STLR Input 1 or 2 are broken or shorted

SFLR Only: When PPR is configured for SFLR applications the home screen space typically reserved for Inputs 3 will automatically be updated to display as shown in Figure 46 below.



Figure 46: SFLR Application Home Screen

- Loss of Signal Set Point - SFLR loss of signal alarm setpoint value
- High Flow Set Point - SFLR High Flow alarm setpoint value
- SFLR Alarm Bar Graph – This is a relative bar graph indicating the relationship between the Current SFLR Process Measurement, the Loss of Signal Set Point and the High Flow Set Points.
 - The bar graph is scaled in the same units as the SFLR input
 - The scale of the bar graph is shown to the left and right of the graph.
 - Green color: Indicates that the Current SFLR Process Measurement is In-Range or between the Loss of Signal Set Point and the High Flow Set Point
 - Red Color: Indicates that the Current SFLR Process Measurement is Out of Range. Either Below the Loss of Signal Set Point or above the High Flow Set Point

4.3.3 View Chart Screen

To view previously recorded data in a dynamic format go to the View Chart screen from the home screen. View Chart allows the user to set a custom time span for the start and end period of the data they need to view, Add Notes to previously recorded data and view full detail of previously recorded annotations through the PPR HMI. To view Static Chart images with approval information, see Section 4.4.6 of this manual.

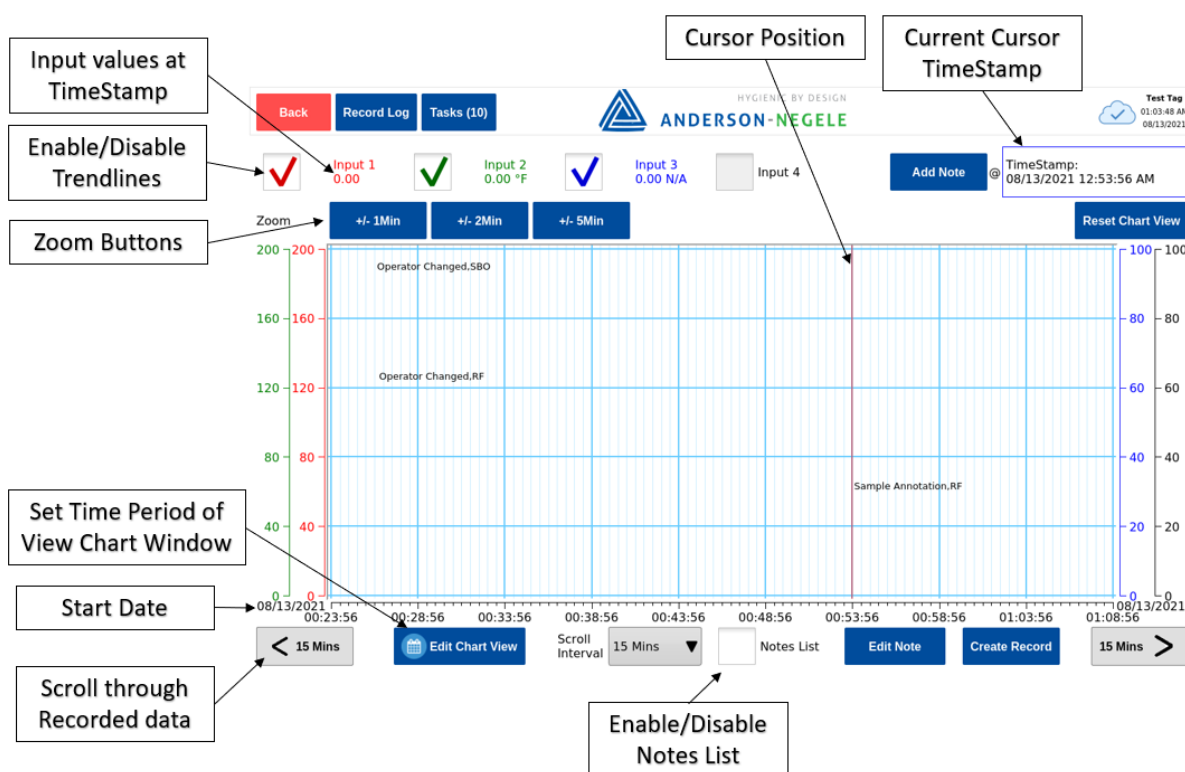

Figure 47: View Chart Screen

- Enable / Disable Trendlines – Shown as the configured input names in Figure 47, selecting this check box will enable (show) the trendline and deselecting will disable (hide) the trendline in the View chart screen.
- Start and End Date – Start Date of chart period is Shown in Figure 47, end date is located in the bottom right of the view chart screen.
- Edit Chart View – Pressing this button will allow a user to set a precise time for the beginning and end of the View chart period.
- Zoom Buttons – Zoom buttons allow the user to quickly zoom in on the current cursor position by the time period indicated on the button. E.g. +/- 2Min will change the chart period to be 4 minutes, two minutes before the cursor position and 2 minutes after.
- Reset Chart View – Changes the chart view back to the default time period that was seen when the user first entered the screen.
- Scroll Interval – Selectable time increment that changes the amount of time that the scroll buttons increment the chart when pressed.
- Time Scroll Button – Shown in Figure 47 as “Scroll through Recorded Data”, these buttons increment the chart when pressed by the Scroll Interval that is displayed on the face of the button.
- Cursor Position – Red vertical line on the View chart screen, which is displayed above the chart as “TimeStamp”. User can touch any part of the chart to change the cursor position. The Cursor Position becomes the timestamp associated with new annotations in the Add Notes workflow.
- Y Axis Labels – Input 1 y-axis and Input 3 y-axis labels are on the left side of the graph. Input 2 y-axis and Input 4 y-axis are on the right side of the graph.
- Add Notes Button – Add annotation at current cursor position. See Additional information in Section 4.4.3.2 of this manual
- Notes List – Selecting this check box will enable (show) the Annotation List as seen in Figure 47 and deselecting will disable (hide) the Annotation List in the View chart screen allowing for the Chart to display on a larger portion of the HMI.

4.3.4 User Authentication

Several workflows in the PPR will lead the user to the authentication screen, including adding annotations, performing calibration, and changing configuration. The list of users shown on the left side of this screen are all the “Active Employees” managed in Legendary.

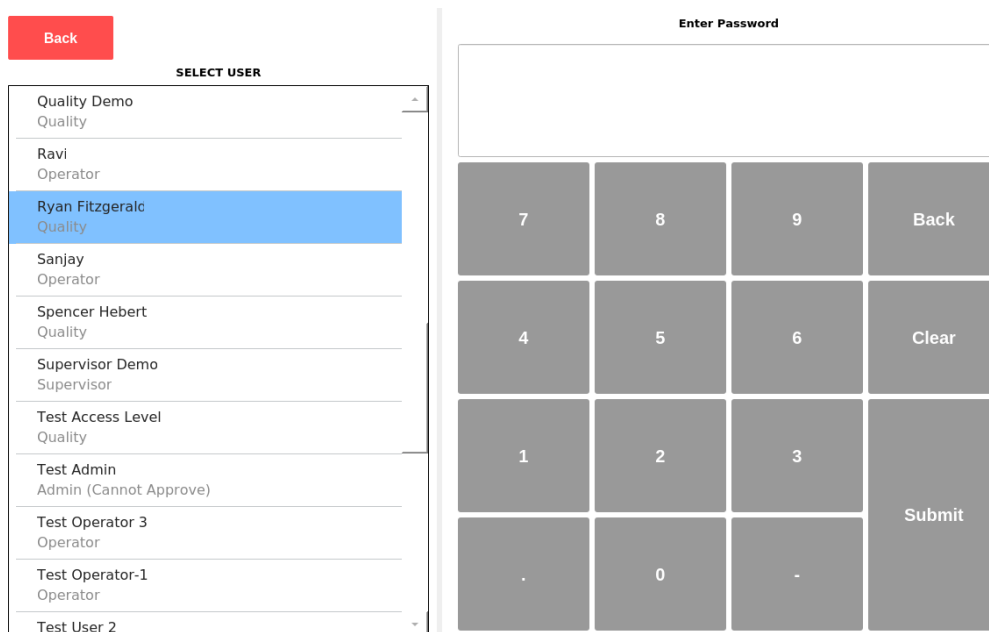

Figure 48: User Authentication Screen

User Authentication

- **User List** – List of active employees associated with that PPR. The top row displays the employees First and Last Name, the bottom row displays the Users Legendary™ Role. By default, the last authenticated user is preselected when entering the User Authentication screen, but any other user can be selected before their PIN is entered.
 - If list appears empty, ensure the PPR is connected to Legendary. See Section 5.1 of this manual for additional information.
- **PIN Code** – A numeric Personal Identification Number specific to each user. To change this number, see Section 4.4.7 of this manual.
 - Figure 49: Forgotten PIN Error Message shows the notification window that will appear when incorrect pin code is entered. User account will be locked when incorrect password is entered more than 5 times. If a User forgets their PIN, please contact your Plants Legendary™ Administrator.

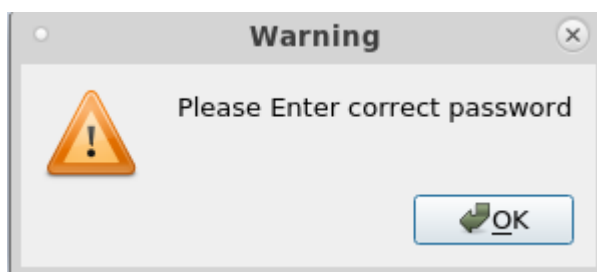

Figure 49: Forgotten PIN Error Message

User Authentication Process / Workflow

When Prompted with the user authentication screen seen in Figure 48 above, follow these steps to authenticate.

1. Select your own Username from the left side of the HMI
2. Type PIN using onscreen keypad
 - a. Press “Back” on keypad to backspace
 - b. Press “Clear” on keypad to remove all entered numbers
 - c. Press Back in top left corner to return to previous screen
3. Press Submit when PIN is fully entered.

4.3.5 Version Information

The version screen is accessible to all users through the PPR Menu, it provides access to the overview tab and software tab. This menu screen will provide users with access to all hardware and software version information as well as the ability to update the PPR software. In regulated applications the version revision information can also be monitored by the inspector or applicable parties to verify that updates have not been installed between 3rd party inspections.

4.3.5.1 Overview

The Overview tab within the Version screen displays the software and firmware(s) version information for the applicable PPR hardware, as shown below in Figure 50. Additionally, internal, and external memory storage capacity are displayed on this screen. Information displayed on this screen may be critical to share with the Anderson-Negele Support team if troubleshooting of a PPR or Legendary™ issue is required.

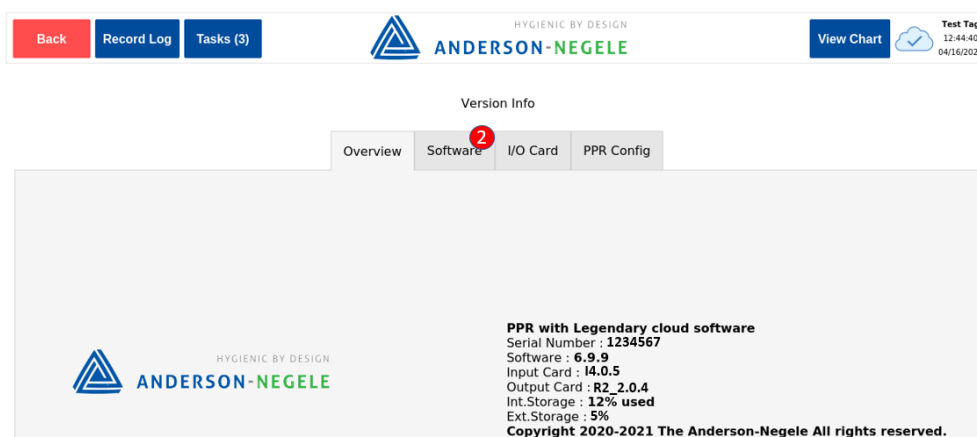

Figure 50: Version Overview screen

- Serial Number – The unique serial number assigned to the PPR System on Module (SOM) board. This number is only written by the AN team during the manufacturing process and cannot be modified in the field.

- Software – The current software version installed on the PPR SOM, this software controls how the PPR HMI displays information, whereas the firmware controls how inputs and outputs are measured and controlled.
- Input Card – The current firmware version installed on the input micro-controller. The Input microcontroller controls measurement of data from input channels 1-4.
 - **STLR/ SFLR Only** – In addition to input channel 1-4 measurement, this micro-controller firmware controls the functionality of the STLR relay output, STLR microswitch (valve) position detection, and SFLR relay output (when equipped).
- Output Card – The current firmware version installed on the output microcontroller. The output microcontroller controls the functionality on non-STLR/SFLR outputs such as mA retransmission and optional relay outputs.
- Int. Storage – (Internal Storage) Displays the % of eMMC that is currently being used to store data
 - **STLR/ SFLR Only** – If internal storage exceeds 99% capacity the STLR and SFLR relays will automatically deactivate.
- Ext. Storage – (External Storage) Displays the % of MicroSD that is currently being used to store data

4.3.5.2 Software

The software tab will display the current software version (Installed Package Name:) running on the PPR as well as other newer versions available for installation. A red notification bubble will appear on the PPR when a software update is available for download.

Software Updates: PPR enables authorized users to install over the air (OTA) software updates, which must be initiated through the PPR HMI. To check for new software updates, press the *Check Updates* button located on the top right portion of the Software screen, see Figure 51 below. Access to install software updates is limited to Users with configuration access credentials (controlled in Legendary™)

Note: Some software updates contain embedded firmware updates.

To update the Current version of PPR Software follow the process below;

1. Move the Run/Program (J9) Jumper to the Program position
2. Identify the version of software that you want to install
 - a. Touch the File Name to see additional information and release notes from AN
3. Touch the *Install* button located to the left of the desired software version
4. Enter valid user credentials following the User Authentication workflow.
 - a. Note: Installing Software will temporarily cause the PPR to stop recording data and outputs will be disabled
5. Wait for the progress bar to indicate that the software has been fully installed (typically within 5 minutes)
 - a. Warning: Never turn off the PPR during a software installation.
6. When prompted with an on-screen message to reboot the system, Power cycle the PPR.

- a. User can validate that the installation was successful by returning to the version overview screen

Version Info

Overview Software I/O Card PPR Config

Installed Package Name: SW-6.5.5NFW
Installed Date: 01/01/2021 4:44:22

Check Updates

Available Software Updates

| | | File Name(Click for version info) | Release Date |
|---|---------|-----------------------------------|---------------------|
| 1 | Install | SW-6.9.0NFW | 02/11/2021 04:00:00 |
| 2 | Install | SW-6.9.9NFW | 03/18/2021 12:30:00 |

Figure 51: Version Software Screen

4.3.6 System Activity Log

The PPR automatically records changes in, or the occurrence of the following events in the system activity log;

- Configuration
- Calibration
- Software Updates
- J9 jumper position
- Power on & off events
- System Time
- Input errors and failures
- Detection of Removable storage device

These events cannot be manually added or removed from the System Activity Log.

To view the System Activity Log, follow the process below;

1. From the home screen Select *Menu*
2. Select *System Activity Logs* to view a log similar to Figure 52 below

When Viewing the System Activity Log, you can apply filters to look for specific events by following the steps below;

1. Search for specific Event Types by pressing the white field below Event Types and apply a text search using the onscreen QWERTY keyboard.
2. Search for specific Event Description by pressing the white field below Event Description and apply a text search by using the onscreen QWERTY keyboard.
3. Search for events that happened on a specific date by applying the Date Filter.

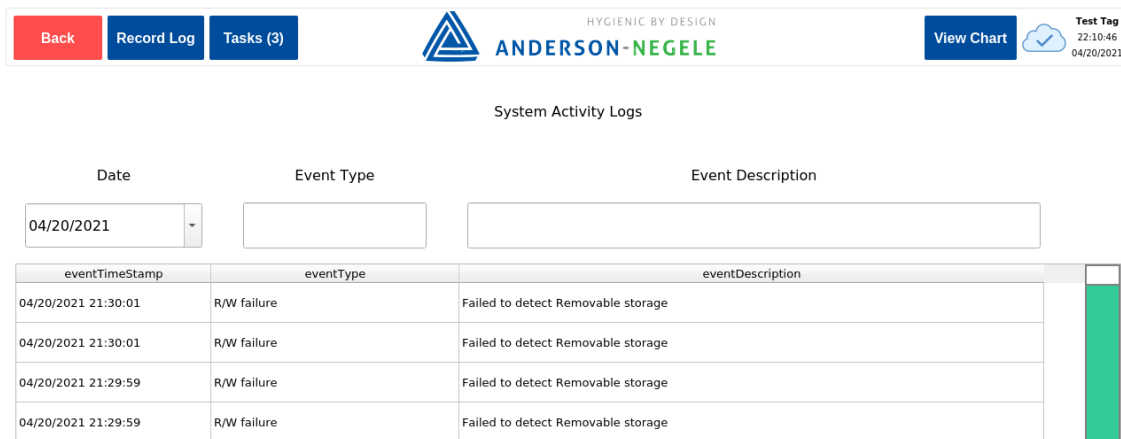

Figure 52: Sample View of System Activity Log

4.4 Common Interactions

4.4.1 User Login/Logout

Any user can sign-in and create an annotation on the record with their Name by touching the Operators list seen in Figure 53, then completing the authentication workflow.



Figure 53: Operator Change

If the User is able to properly authenticate the annotation created on the Record will appear as “Operator Changed, FL” where FL is the First and Last initial of the new operator who signed in to PPR.

4.4.2 Reviewing Process Data/Trend

Recent and historical process data can be viewed by clicking on *View Chart* button in the home screen. See section 4.3.3 for descriptions of navigation and interactions possible in Chart View screen.

4.4.3 Adding Annotations to PPR Records

Annotations can be added to a record through two different workflows; 1) System Information annotations or 2) Add Notes annotations. Both workflows require valid user credentials before the annotation information is added to the PPR memory and the Record. Once an annotation

is added to PPR it can always be viewed on the View Chart screen when viewing the corresponding chart period. If the annotation is later edited only the updated annotation will appear on the PPR record.

4.4.3.1 System Information (Info) Annotations

This workflow is designed to enable the user to quickly add information to a real time datapoint from the home screen. This workflow is typically used to record changes in the system or process information such as the change in product, source tank, or batch number. To initiate a system information annotation, follow the process below.

1. Touch any of the system info annotation fields on the top of the home screen. Seen in Figure 53 above.
2. Select any combination of the preconfigured system info annotations (limit 1 from each list)
 - a. Unused system info fields can be cleared with the *Clear Selection* button or all previous annotation selections can be cleared with *Clear All* button.
 - b. Each Preconfigured System Info field can be modified by touching the field directly below the column header. e.g. the blank field under the “Annotation” header, or RT-2 field under the “Batch” header

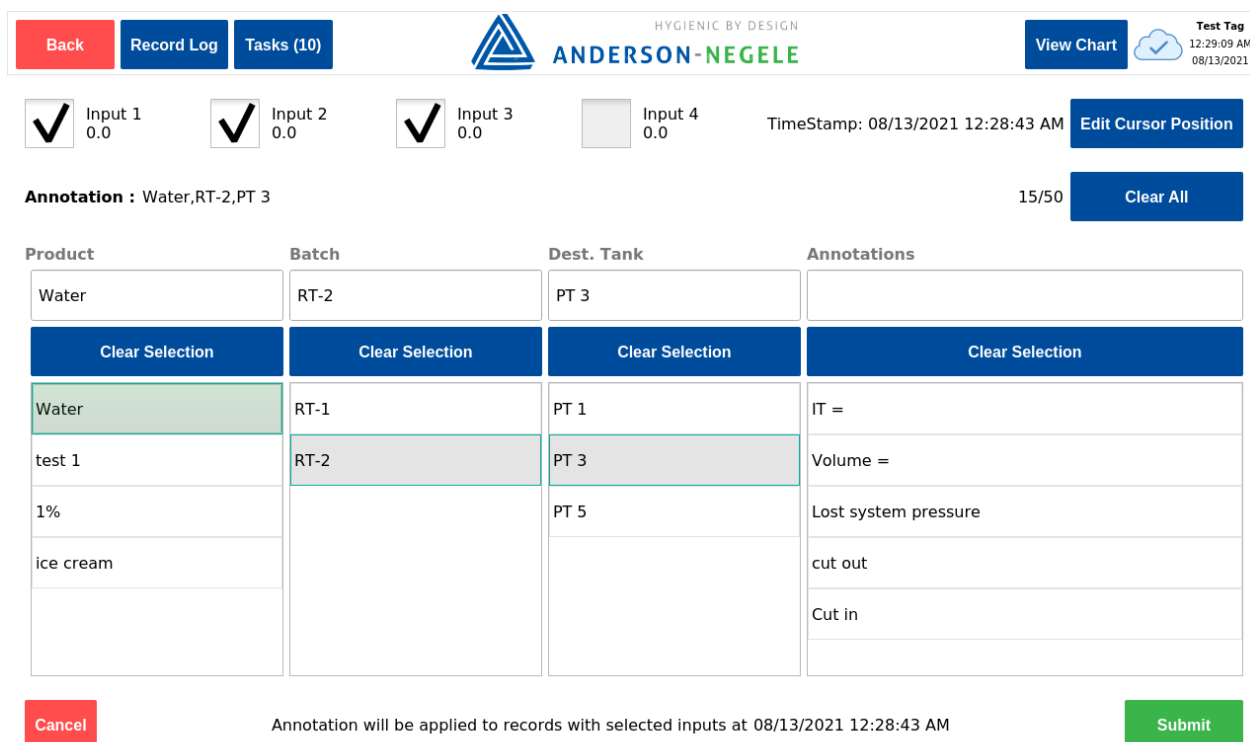

Figure 54: Selecting Multiple System Info Fields for Single Annotation

3. Validate the combined annotation text is as desired in the top left section of the screen.
 - a. In Figure 54 above the annotation will read “Water,RT-2,PT-3” followed by the initials of the user who submits
 - b. If edits are needed each field can be modified independently

4. Press *Submit* button in lower right corner
5. Enter valid user credentials following the User Authentication workflow.
6. When the user is properly authenticated with their PIN number the annotation will be added to the record. This annotation can immediately be seen by clicking the *View Chart* button.

4.4.3.2 Adding Annotation from View Chart Screen

This workflow is designed to enable the user to add information to a historical data point as the PPR continues to record data. This workflow is commonly used to annotate information that happened in the past such as product changes, wash cycles and unexpected events. To Add Notes through this workflow, follow these steps;

1. Click *View Chart* in the home screen.
2. View the desired chart time frame by adjusting the start date and time and end date and time. See section 4.3.3 of this manual for additional information about navigating the View Chart screen.
3. Click anywhere on the graph to change the cursor position. Ensure the cursor position is at the desired time stamp by viewing the TimeStamp above the HMI Chart View.
 1. User can increase the data display resolution by viewing a smaller Time frame on the x-axis, this can be achieved with the *Zoom* buttons shown directly above the graph.
4. The user can also verify the input values at that point in time by viewing the area above the chart screen shown in Figure 55

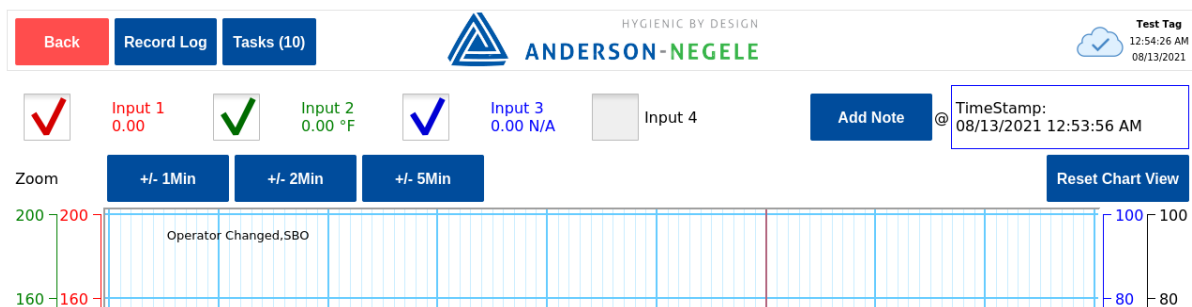

Figure 55: View Process data at Time Stamp

5. Touch the *Add Note* button in the top right corner of the View Chart screen to add an annotation to the selected cursor position.
6. Enter valid user credentials following the User Authentication workflow.
7. Select from the list of pre-configured annotations See Figure 56
 - a. Alternatively, the user can edit the annotation before submitting it by first selecting a predefined annotation, then clicking in the New/Selected Annotation field at the top of the screen. Use the onscreen QWERTY keyboard to add additional text to or edit the existing text.
8. Touch the green *Submit* button, to add the annotation text displayed in the New/Selected Annotation field to the record.

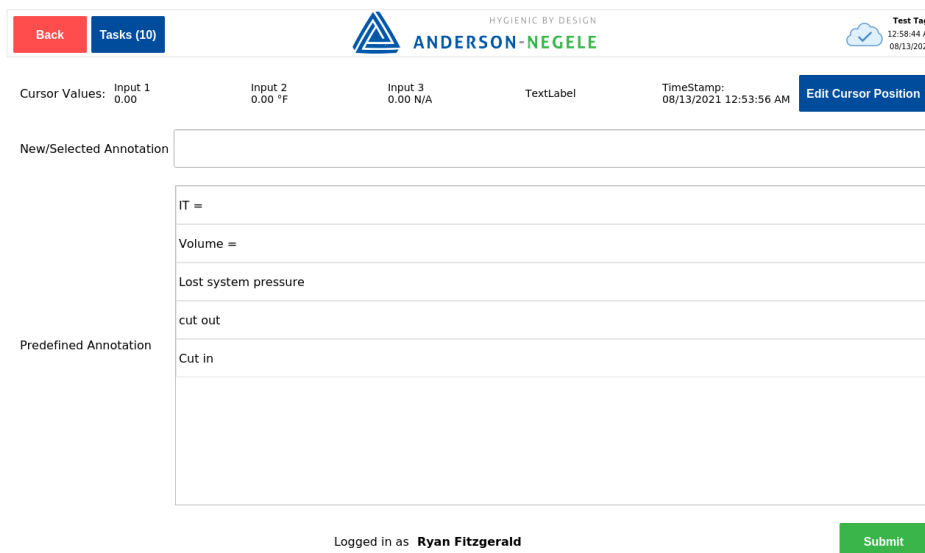

Figure 56: Pre-Configured Add Notes Annotations

9. Custom annotations can also be added by pressing the custom annotation field (rather than a predefined annotation) then Use the onscreen QWERTY keyboard to populate the annotation text and click Submit, to add the annotation to the record.
10. After the annotation is successfully added to the PPR Memory a Confirmation dialog box will be displayed showing Annotation added successfully.

4.4.3.3 System Generated Annotations

The PPR automatically records certain system events as System Generated Annotations on the current Record Period. The following events automatically annotated;

- Configuration changes (once per configuration menu)
- Calibration (once per calibration menu)
- Software Updates (Every Change)
- J9 jumper position (Every Change)
- Power on & off events (Every Change)
- System Time (Every Change)
- Input errors and failures (Recorded at the beginning of the error/failure)

See Section 2.1.3.1 for additional information regarding viewing and editing System Generated Annotations.

4.4.3.4 Editing Annotations

PPR Users can edit or update any annotation created through the Add Notes or System Information annotation workflows after they are added to the record with the Edit Annotation workflow. Users can not edit System Generated Annotations that are automatically generated by the PPR, See Section 4.4.3.3 for additional information.

When annotations are edited, the original annotation will be deselected (hidden) on the Annotations list of the View Chart screen. The original annotation is not displayed on PPR Records, the updated/edited annotation is displayed on the PPR record and will automatically include a preceding Delta character to indicate that the text has been edited, as seen in Figure 57 .

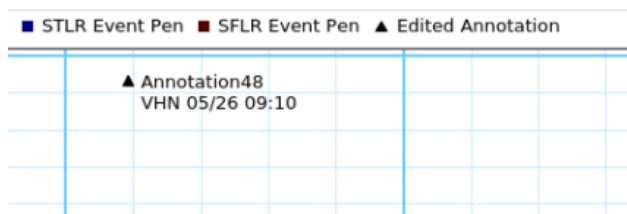

Figure 57: Example of Edited Annotation of Record

To edit an annotation through the PPR, follow the steps below;

1. Select *View Chart* in the home screen to go View Chart Screen
2. Select the *Annotation List* check box to ensure the Annotation List is displayed (shown in Figure 58)

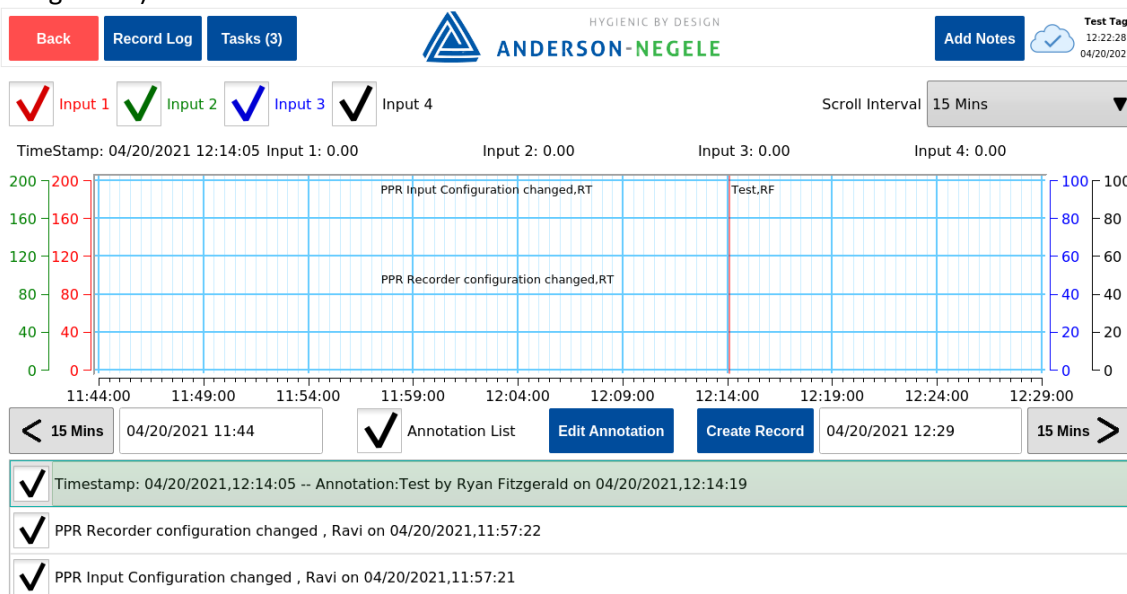

Figure 58: Edit Annotation Workflow

3. Select the annotation that needs to be edited. When the annotation is selected it will be highlighted in the list as shown in Figure 58
4. Select *Edit Annotation* Button
5. Enter valid user credentials following the User Authentication workflow.
 - a. **Edit Text:** To edit the text of the selected annotation, click in the New/Selected Annotation field, use the onscreen QWERTY keyboard to edit the annotation text and click Submit, to add the edited annotation to the PPR record.
 - b. **Edit Cursor Position:** To edit the time where the annotation appears on the record, click in the *Edit Cursor Position* button on the top of the HMI. Select a

new cursor position for the annotation, then click Submit, to add the edited annotation to the PPR record.

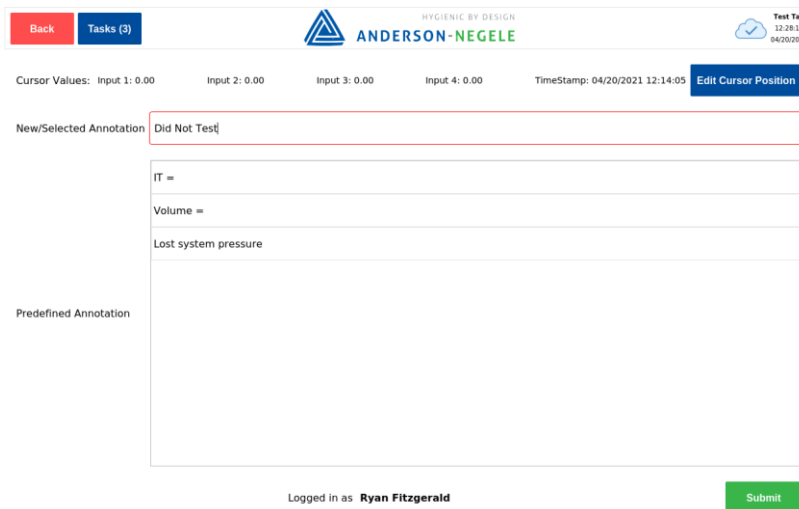

Figure 59: Edit Annotation Text / Cursor Position

4.4.4 Reviewing Records and Approval Workflow Status

To view a previously recorded record or to see the approval status of a record follow the steps below;

1. Press *Record Log* in the top left corner of the home screen
2. On the Right side of the Record Log view the Approved Stage column. Shown in Figure 60 below, without any approvals present.

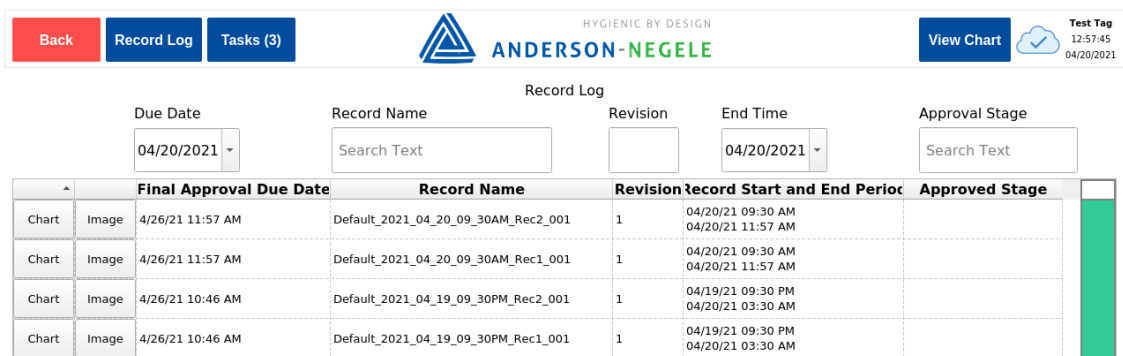

Figure 60: Reviewing Records

3. To review the static record image which also appears in Legendary, press on the *Image* button on the Left side of record log.
4. To see the record contents on the HMI View Chart workflow, press the *Chart* button on the left side of the record log.

To approve a Record Image see Section 4.4.6 of this Manual.

4.4.4.1 Temporary Record Creation

For troubleshooting purposes or to validate the current Recorder configuration the User can create Temporary PPR Records on demand by following the steps below. A temporary record

uses the current PPR Record configuration to plot all trendline information and annotation on a record from the latest Record Start time to the moment the *Create Record* button is pressed.

To edit a Temporary PPR Record follow the steps below.

1. Press *View Chart* in the top right corner of the home screen
2. Press *Create Record*
3. Enter valid user credentials following the User Authentication workflow.
4. View the temporary record that was just created by going pressing *Record Log*

Temporary records deviate from standard records produced by PPR in that they appear incomplete as trend line data is missing from the right side of the record. These records are incomplete; thus, they cannot be approved through the standard approval process until the Record Period is concluded. When the record period is concluded the PPR will automatically create a new revision of the previously “Temporary” record with the additional time series data intact. At that point the record can be approved through the standard record approval process.

4.4.5 Reviewing and Closing Tasks

Tasks are questions from Legendary™ users that originate in Legendary™ when someone is reviewing a record image and has questions or would like additional details or annotations. The *Tasks(n)* button displayed on the top of the Home Screen HMI will show a list of all open tasks which require the attention of another an employee. “n” represents the number of open tasks, shown with an example of 5 in Figure 61: Task Button with 5 Open Tasks. When a task is created no one will be able to approve the record for that time period until the task is resolved and closed.

To review, respond and close a task follow the steps below:

1. If a task is required, the number in parenthesis will be a number greater than zero
2. Press the *Tasks (n)* button in the top left corner of the home screen



Figure 61: Task Button with 5 Open Tasks

3. A detailed list of all open tasks will appear, as seen in Figure 62 below
4. Pay attention to the Responsible Group for each item in the list. If any of the tasks shown display your role as the Responsible Group, someone on your team is expecting a response to the question.
5. Read the question and do the requested task as applicable.
6. When the task is completed, press Send Response to close the task. Note: Sending a response does not add any information to the PPR record.

The notification of task completion will be sent to the Legendary™ Software.

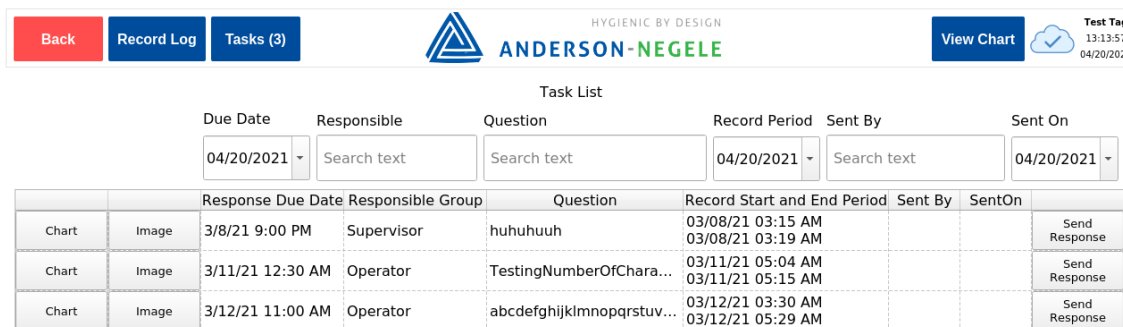

Figure 62: Open Task List

4.4.6 Approving a Record

PPR allows for complete record review and approval through the HMI, thus the approval workflow can continue through PPR even if there is a temporary disconnection to the Legendary™ Cloud Server that inhibits records from being approved in the cloud. Only Static chart images found in the Record Log can be approved, there is no approval workflow for the View Chart screen.

To approve a record through the PPR HMI follow these steps;

1. Press *Record Log* in the top left corner of the home screen
2. On the Right side of the Record Log view the Approved Stage column. Shown in Figure 60 above, without any approvals present.
 1. If approval is added to a record that already contains an approval, a new revision of the record will be created, and the latest approver name time and date stamp will appear on the record.
3. Select the desired record in the Record Log list view, press on the *Image* button on the Left side of record log. PPR will display the latest revision of the record image for that time period including all data trendlines, annotations, approvals, etc.

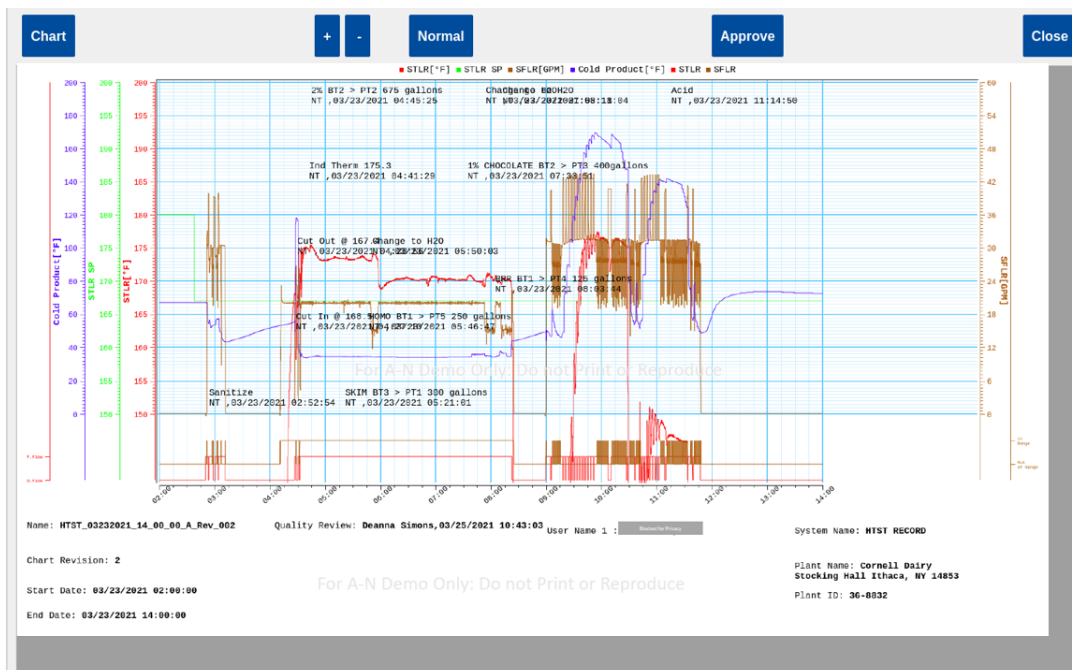

Figure 63: Record Image On PPR

4. A screen will appear like the one shown in Figure 63 above.
5. When applicable press *Approve* to add approval to the record and move the record forward in the approval workflow.
 1. **Information added to record:** Approving a record will increase the record revision, add Responsible Group of Approver, Add Approver’s name, and time and date of approval to the record.
 2. **Approval Workflow Stages:** The approval workflow Stages are defined for this equipment through Legendary
6. Enter valid user credentials following the User Authentication workflow.
 1. User must have a Legendary™ Role associated with one of the Approval Workflow Stages to add approvals to records.
7. The record log screen will appear, the Approved Stage will be updated to reflect the stage of the user who just approved the record.

4.4.7 Changing User’s PIN

All PPR users can change their PIN number through the PPR HMI. If the same user appears on multiple PPRs in the same plant, please allow 15 minutes for the new PIN number to work on other PPRs. To change a PIN, follow the steps below;

1. Press *Menu* in the top left corner of the home screen
2. Press *User Password Management*

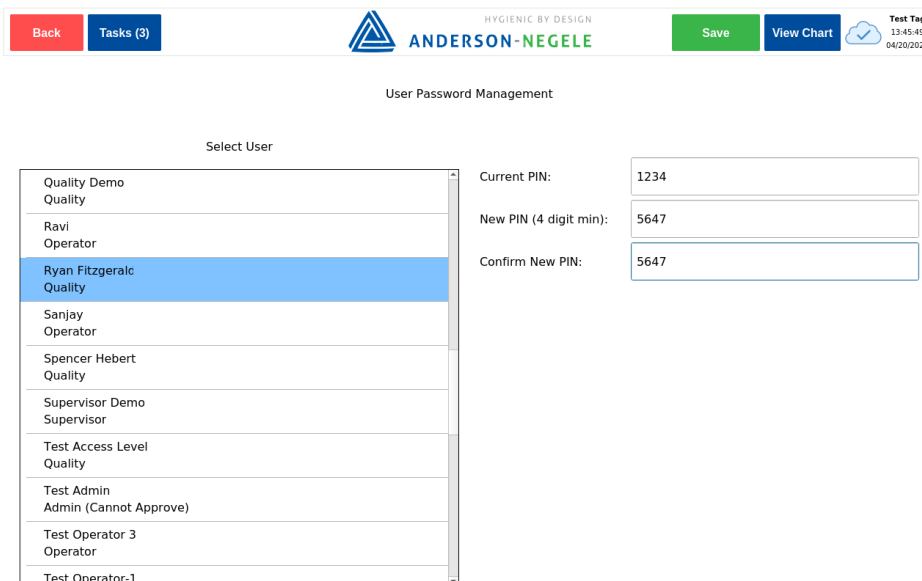

Figure 64: User PIN Change

3. Select the User that desires to change their PIN
4. Select the Current PIN field
5. Use onscreen Keypad to enter the Users Current PIN number
6. Select the New PIN (4-digit min) field
7. Use onscreen Keypad to enter the new PIN
8. Type the same new PIN in the Confirm NEW PIN field.
9. Press *Save* on top of HMI to save this change.

If a User forgets their PIN, please contact your Plants Legendary™ Administrator to have it re-set.

4.4.7.1 Manual User Sync

The PPR will automatically sync user information with Legendary™ on a regular basis, while the PPR has an established connection to the Legendary™ cloud. As needed a PPR user can force the manual sync of users by pressing the *Sync Users* button, seen in Figure 65 below.

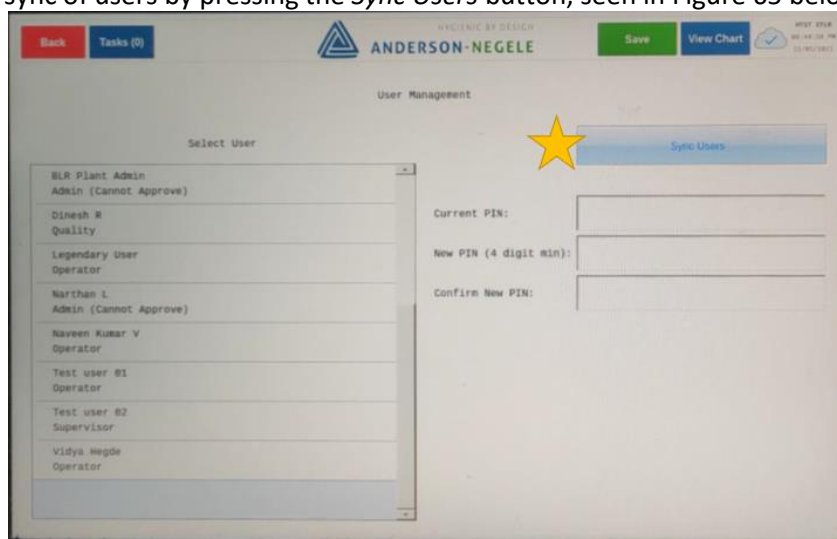

Figure 65: Sync User Button

4.5 Recommended Preventative Maintenance

Calibration Verification

It is recommended that input and output accuracy be verified at least once per year or more frequently to meet the requirements of the application.

Cleaning and Decontamination

There is no cleaning required for the PPR before or during installation. Avoid spraying the PPR directly with high pressure hoses.

As necessary if the PPR becomes contaminated or soiled, use mild soap and water applied to a microfiber cloth to remove any foreign material or deposits on the exterior of the PPR enclosure only.

Gasket Inspection

If the PPR door is opened after the unit has been in service, it is recommended to inspect the gasket for damage such as folds, cracks, tears and permanent deformation. To prevent the ingress of water or dust any gaskets should be replaced immediately if they are damaged as described above.

Backup Batteries

If an uninterrupted power supply is used with the PPR it should be checked regularly to ensure proper operation and battery capacity.

The PPR contains a cr2032 battery, this battery should be replaced on a regular maintenance schedule every 5 years. To avoid losing the system time the PPR needs to remain powered on while this battery is replaced. Qualified personnel should proceed with caution.

5 Configuration

In some regulatory applications the plant is responsible for maintaining a log of any external changes to the recording device. PPR will automatically capture software, firmware, configuration, and calibration updates in its system Activity log.

An input calibration is recommended following any input configuration change or input card change.

Only users with Access Level = 1 in their employee profile within Legendary™ will be able to make changes to configuration.

Configuration changes may be inhibited by the Run / Program Jumper, see Section 2.1.5 of this Manual for additional information.

5.1 Network Configuration

PPR uses a network connection to enable REST API to periodically push data to the Legendary™ cloud server. The status of the network connection can be checked by viewing the Cloud Connectivity Status Icon in the upper right corner of the screen.

If no employees are synced from Legendary™ to a PPR the network configuration menu will automatically become unlocked, as network configuration is required to connect to Legendary™, and a connection to Legendary™ is required to sync users.

All PPRs will be configured as DHCP IP method when they ship from Anderson-Negele. PPR can be configured to use a static or dynamic IP address.

Dynamic IP

Dynamic IP or DHCP method can be used any time there are not network security restrictions which require an IoT device such as PPR to always use the same IP address.

Static IP

Static IP can be used to assign a fixed IP address to the PPR. To change the PPR to a Static IP address, follow the steps below;

1. Obtain the following IP information from the appropriate IT/Network Security team within your organization

| | |
|-----------------------------|--|
| IP Address | <i>e.g. 192.168.140.130</i> |
| Subnet Mask | <i>e.g. 255.255.255.0</i> |
| Default Gateway | <i>e.g. 192.168.140.1</i> |
| Primary DNS Server | <i>e.g. 192.168.150.101, or Public</i> |
| Secondary DNS Server | <i>e.g. 192.168.150.101, or Public</i> |

2. Enter the Network Configuration menu
3. Press unlock and enter user credentials
4. Press the *configuration* button in bottom right corner
5. Change IP Method to “Manual”
6. Check the “Auto Connection” Box in top left corner
7. Enter all applicable Static IP information collected in Step 1
8. Press *Save*.

Figure 66 below shows an example of a valid Static IP configuration.

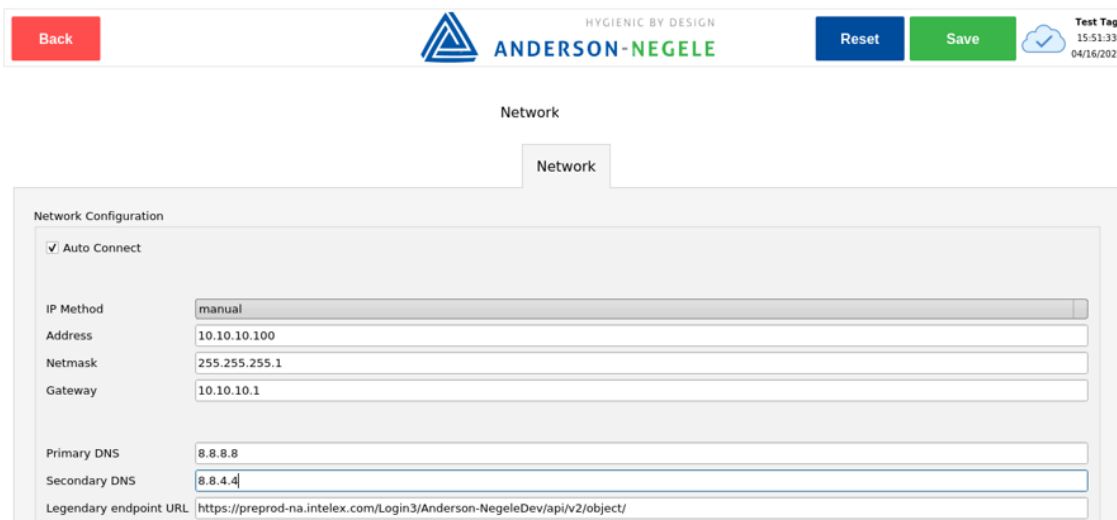

Figure 66: Static IP Configuration example

DNS Configuration

For either IP Method a primary and secondary Dynamic Name Server (DNS) must be configured in the Network configuration section. If the plant’s network administration team does not specify the DNS to use, there are multiple public DNS options available such as Google’s 8.8.8.8 & 8.8.4.4.

Destination Domain – Legendary™ Endpoint URL

The Legendary™ end point URL is the Destination domain to which PPR is configured to send data; this web address can be viewed in the network configuration menu after user authentication. The plant’s network firewall settings must allow outbound communication between PPR and this destination domain.

Legendary™ endpoint URL is configured by Anderson-Negele and cannot be changed by a customer.

MAC Address

The MAC address for each PPR can be seen on the bottom of the PPR home screen when the device is powered up and an active ethernet connection exists. Example shown in Figure 67.

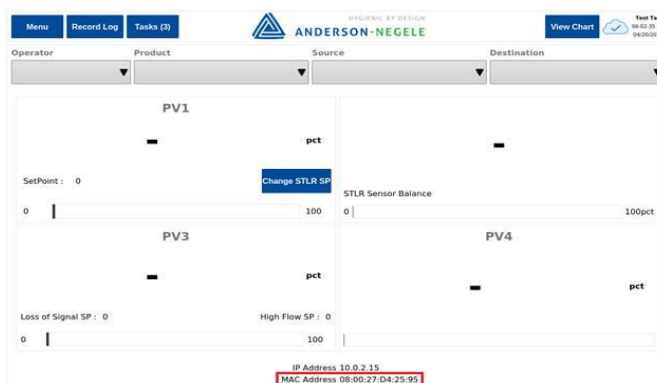

Figure 67: MAC Address on Home Screen

5.1.1 Connectivity Status and Troubleshooting

Cloud Connectivity Status Icon

At all times the PPR HMI displays one of the following Cloud Icons in the Navigation bar.



Connected – There was a successful API call to the Legendary™ server within the last 15 minutes



Not connected – the last API call to the Legendary™ server failed



Syncing – The PPR is in the process of establishing communication with the Legendary™ Server

Ping

The Network Configuration menu of the PPR allows for a user to prove network connectivity to either a web address or IP address by using the built in Ping feature, see Figure 68. To use the Ping feature, follow these steps;

1. Unlock the Configure Network Menu by pressing Unlock
2. Enter valid user access credentials
3. Click in the white field to the right of the blue *Ping* button
4. Type a web address or IP/gateway address
5. Press *Submit*
6. Press the blue *Ping* Button
 - a. Connected: There was a successful Ping of the defined address
 - b. Not Connected: Pinging the defined address timed out

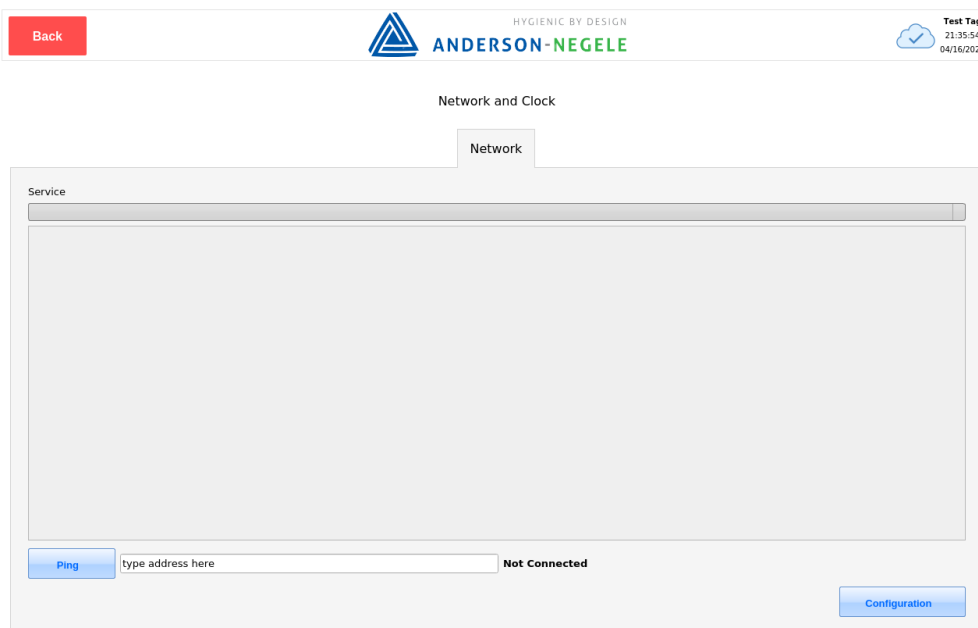

Figure 68: Ping Feature

Ethernet Cable Connection

When the ethernet cable is seated properly and connected to a live network the RJ45 port within the PPR SOM will have a series of flashing lights around the port as seen in Figure 69 below. If no lights are observed around the port, ensure the connector is properly seated into the RJ45 jack. If problem persists, contact your network administrator.

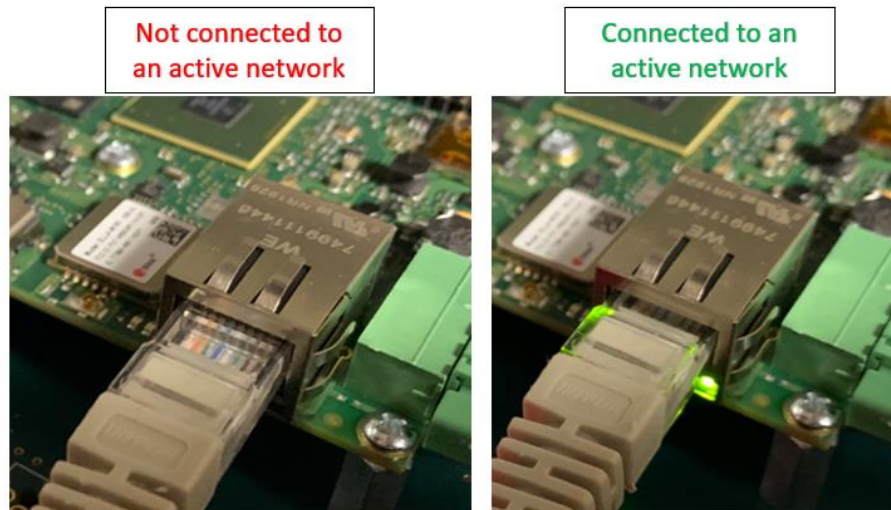

Figure 69: Ethernet Cable Connection

5.2 Date & Time

During configuration the PPR acquires the time and date from the Legendary™ cloud server, thus a valid network connection to Legendary™ is required before changing any time any date configuration. Once configured PPR uses an internal clock to keep the system time, this time is used to timestamp all PPR recorded data, annotations, approvals, etc. The current PPR system time can always be seen in the top right corner of the PPR HMI, as shown in Figure 70 below.

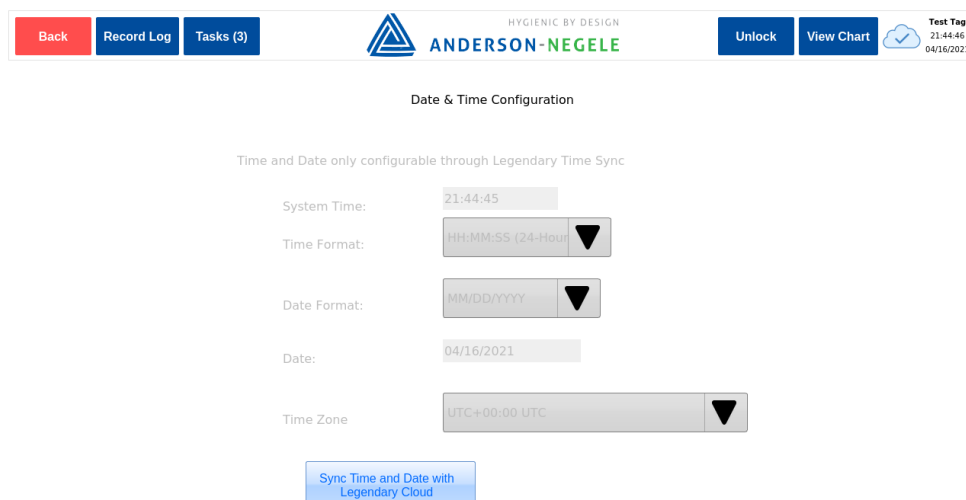

Figure 70: Date and Time Configuration Menu

Battery Backup

When the PPR power supply is disconnected the system, time is retained using a 3VDC battery backup. The battery type is cr2032, this battery should be replaced on a regular maintenance schedule every 5 years. To avoid losing the system time the PPR needs to remain powered on while this battery is replaced. Qualified personnel should proceed with caution.

Setting the PPR time

A PPR user can configure the Time format, Date format and Time Zone. To change these configured options, follow these steps;

1. Unlock the Date & Time Menu by pressing Unlock
2. Enter valid user access credentials
3. Select desired *Time Format* from dropdown menu
4. Select desired *Date Format* from dropdown menu
5. Select the *Time Zone* where PPR is installed from dropdown menu
6. Press *Sync Time and Date with Legendary Cloud* button
 - a. Sync Successful: The current Date and time were successful acquired from the Legendary™ time server.
 - b. Sync Unsuccessful: PPR could not connect to the Legendary™ time server. Check Network configuration.

5.2.1 Daylight Savings Time

The PPR is designed to automatically accommodate the time change related to Daylight Savings Time and will continue to record data during these bi-annual events. When time is set back in the fall the PPR will automatically update the x-axis to include the hour that is repeated, as seen in Figure 71 below.

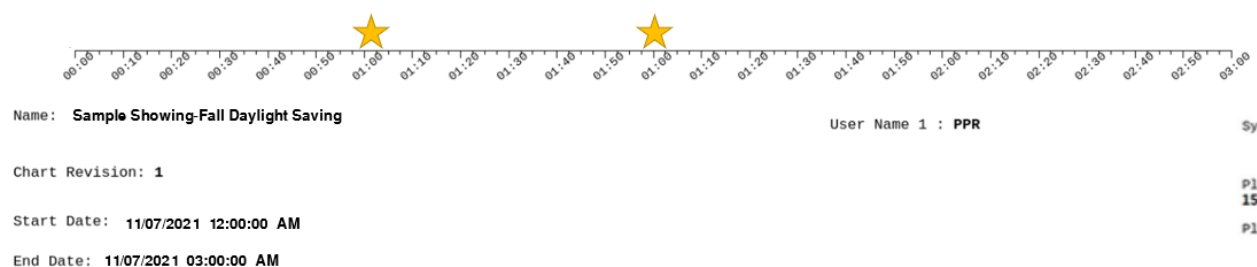

Figure 71: Example of Fall Daylight Saving Record

When the time is advanced forward in the spring the PPR will automatically advance the x-axis of the chart to skip the hour that is advanced. An example of this behavior can be seen in Figure 1Figure 72 below.

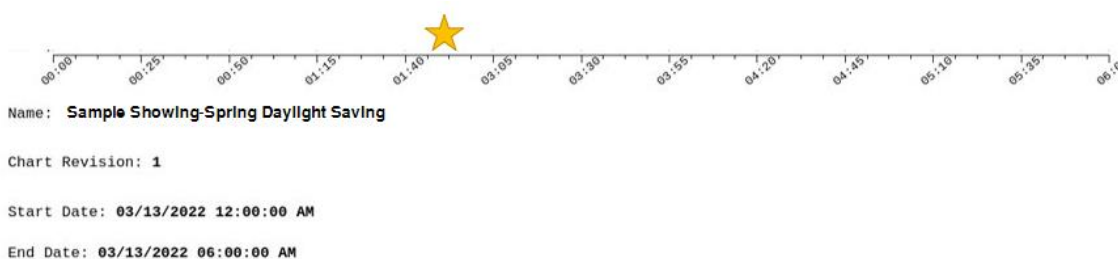

Figure 72: Example of Spring Daylight Saving Record

5.3 Input Configuration

PPR allows for several different sensor input types, each allowing a unique configuration. When entering the Input configuration menu a tab for each input channel will be displayed bearing the input channels current display name as seen in Figure 73 below.

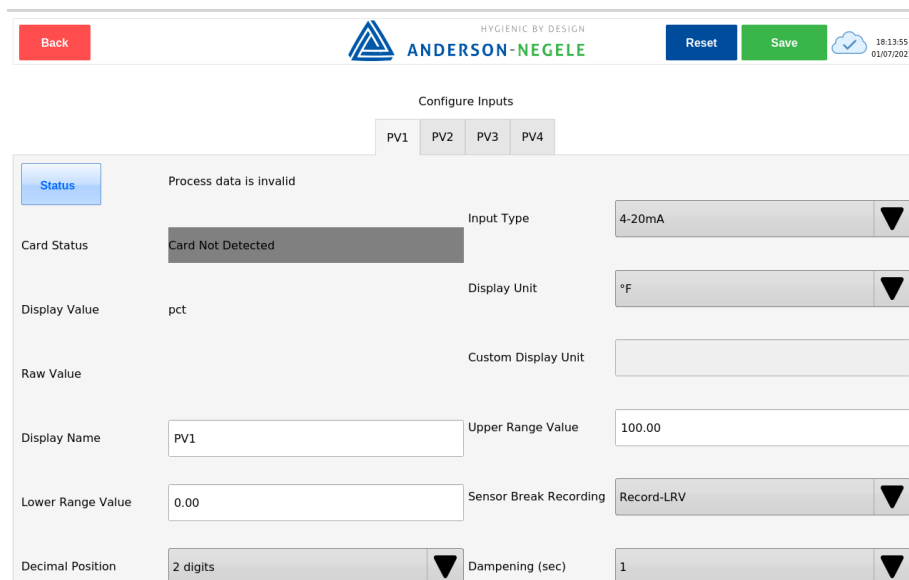

Figure 73: Input Configuration Menu

5.3.1 Input Parameters and Fields

- Status - Pressing the blue *Status* button instantly checks the input card status
 - Process data is invalid: Input is out disconnected or out of range
 - Process data is valid: The measured value is within configured range
- Display Value (Read Only) – The measured input value converted to the Display Unit using the input range “Lower Range Value” and Upper Range Value” fields.
 - Pressing the blue *Status* button will update this value while in the input configuration menu.
- Raw Value (Read Only) – The measured input value displayed in native units
 - Example: Ω for PT100 input type, mA for 4-20mA input type
- Display Name - Name of the input that is displayed on home screen, chart view, record legend, etc.

- Recommended Value - Describe what the PPR is measuring on this input channel. e.g. Silo X, Flow
 - Limits – 12 Characters. Not configurable on STLR/SFLR inputs
- Input Type: User selectable list of input types. The selected input type must match the physical Input Module installed in the PPR input channel. Unused inputs can be disabled by selecting “Disable Input” for the applicable input channels
 - Recommended Value – Match the process sensor that is installed on the PPR input channel
 - Unused inputs can be disabled by selecting “Disable Input” for the applicable input channels. Disabled inputs will not record any input.
 - Limits – **STLR Only**: Input 1 and 2 must be Dual PT1000, selectable (°C/°F).
 - Input “R module” required for this application
 - Limits – **SFLR Only**: SFLR applications: Input 3 must be 0-20mA or 4-20mA.
 - Input “U module” required for this application
- Display Unit – Input type is converted from native units to display units. Data is displayed and recorded in Display units on PPR.
 - Recommended Value – Define what units are displayed when the input type is converted to display units. For transmitter sensor inputs this range is defined by the sensor
 - Limits – Select via Dropdown, or Select custom
- Custom Display Unit – User configurable display units applicable when the desired display units are not selectable in the drop-down list.
 - Recommended Value – Define what units are displayed when the input type is converted to display units.
 - Limits – Only applicable when Display Unit is set to Custom. 6 Character maximum.
- Lower Range Value – Lower limit of the input display range.
 - Recommended Value – Match the input sensors range.
 - Example: If input type is 4-20mA and the transmitter range is 0°F - 200°F The input Lower Range Value 0°F
 - Limits – Numerical Value
- Upper Range Value – Upper limit of the input display range.
 - Recommended Value – Match the input sensors range.
 - Example: If input type is 4-20mA and the transmitter range is 0°F - 200°F the input Upper Range Value 200°F
 - Limits – Numerical Value
- Decimal Position – Number of digits that will appear in home screen after the decimal point.
 - Recommended Value – 0 - 2 depending on input type and display range.
 - Limits – Min:0, Max:6

- Dampening (sec) – Time constant used for filter dampening of PPR inputs. Dampening inputs will reduce measurement noise. Additional description of Dampening is provided below.
 - Recommended Value – 1-2 seconds for most input types
 - Limits – Select via Dropdown
 - Limits – **STLR Only:** This parameter is not configurable on STLR inputs
- Sensor Break Recording – How data is displayed on a PPR record when an input sensor error occurs.
 - Record Sensor Break – Displays a gap in input trendline data when input error occurs.
 - Record LRV – Displays the input trendline at the Lower Recording Range when input error occurs.
 - Record URV – Displays the input trendline at the Upper Recording Range when input error occurs.
 - Recommended Value – This parameter should be configured to record a data in a fail-safe state.
 - Fail Safe Example – If PPR is used to prove that a process happened above a defined temperature, the Sensor Break Recording for that temperature input should be configured to Record LRV to ensure the record does not misrepresent the process if an input error occurs.
 - Limits – Select via Dropdown

Sensor Break Recording

Sensor Break Recording defines how PPR will display and record data when Input errors occur. Input errors may include disconnected sensor, shorted sensor, open resistance measurement or other out-of-range conditions measured by the PPR Input microcontroller. When any of these input error conditions occur, the PPR software will record the error with an annotation on the record and record the input trendline as defined by this parameter for the duration of the input error condition.

Input Out-of-range is defined as input measurement values that are 2.5% of Input Type Span below the Input type lower range limit or 2.5% above the input type upper range limit.

- Input Out of Range Example – Input type is configured as 4-20mA
 - Input type span = 16 mA
 - 2.5% of Input type span = 0.4mA
 - Input type lower range limit = 4mA
 - Input type Upper range limit = 20mA
 - Out of Range Low: Measured Input < 3.6mA (4mA – 0.4mA = 3.6mA)
 - Out of Range High: Measured Input > 20.4mA (20mA + 0.4mA = 20.4mA)

Dampening

To minimize high frequency input noise the PPR offers an input dampening feature. The Dampening feature uses exponential smoothing with a dampening constant entered by the user in Seconds. Increasing the dampening constant will reduce the amount of measured process noise.

The PPR measures each process input every 75-100mS. The user can configure the frequency at which process data is recorded, see section 5.4.1

5.3.2 Changing Input Configuration

Changing the Input configuration will temporarily disable PPR recording and disable outputs. A user with appropriate user credentials can change the input configuration through PPR HMI by following these steps;

1. Unlock the Configure Inputs Menu by pressing Unlock
2. Enter valid user access credentials
3. Select the *Input Tab* that needs to be configured
4. Change the Input Configuration parameters as desired
5. Press Save
 - a. Changes are only saved on the active tab when *Save* button is pressed
6. Following Input changes, the user will be taken to the Recorder Configuration Screen automatically. Ensure all recorded Inputs and ranges are still applicable, then resave the Recorder Configuration.

5.4 Recorder Configuration

PPR can be used in a variety of process recording applications potentially replacing several paper traditional recorders with a single PPR as PPR can create multiple records for a single time period. When entering the Configure Recorder menu (seen in Figure 74 below) the user will see several different configuration tabs. Always start the process of recorder configuration with the Recorder Setup tab, as selections on this menu may inhibit or allow for other configuration menus.

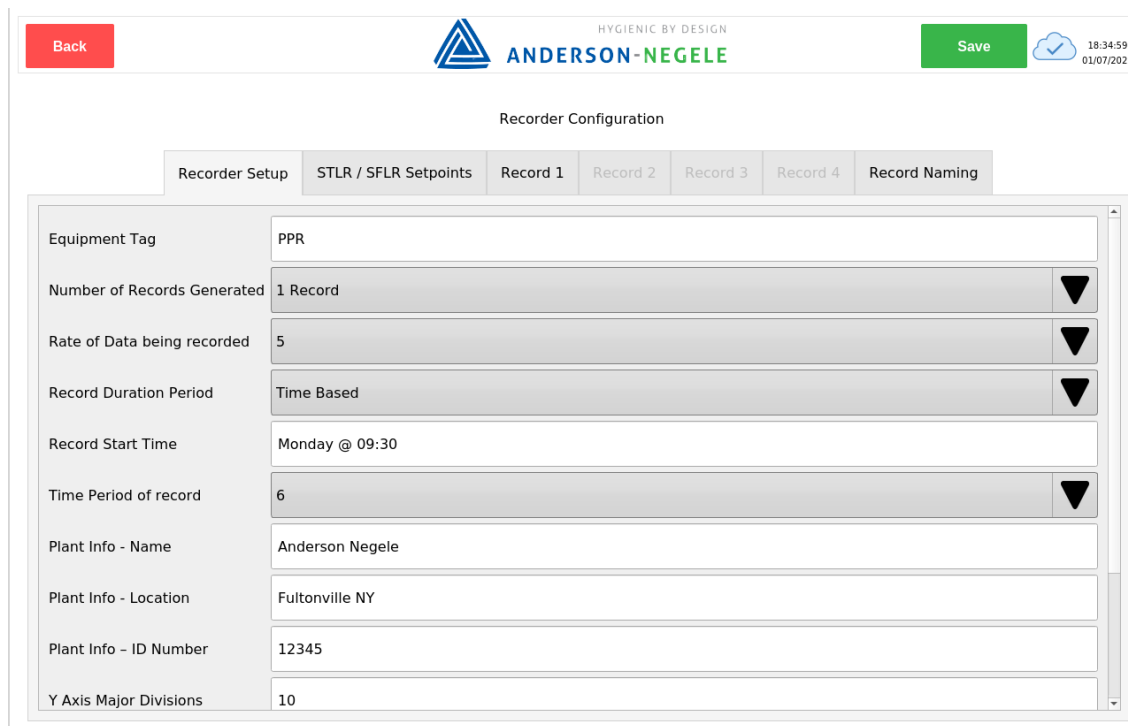

Figure 74: Configure Recorder, Recorder Setup

5.4.1 Recorder Setup Parameters

- Equipment Tag – The Equipment Tag is the name of the Paperless Process Recorder, this name appears on the home screen of PPR, in Legendary™ and on every record PPR creates.
 - Recommended Value – Name of process being recorded
 - Examples – HTST1, Cold Tank #2, CIP 4004
 - Limits – Maximum of 12 Characters
- Number of Records Generated – PPR can be configured to create between 1 and 4 unique records per time period.
 - Recommended Value – Multiple records should be created when there is a desire to review data from different inputs on unique records
 - Limits – Select via Dropdown
- Rate of Data Being Recorded – The Frequency at which PPR writes process data to internal memory, this is independent of frequency at which input data is measured by PPR. This parameter is measured in seconds, choose a lower number to record data more frequently.
 - Recommended Value – Record data at a more frequent rate for processes which require rapid changes to be recorded
 - Limits – Select from Dropdown, frequency range of 3 seconds to 30 seconds.
 - **STLR Only:** Changes in the state of the Event Pen are recorded independent of this parameter.
 - **SFLR Only:** Changes in the state of the Event Pen are recorded independent of this parameter.

- Record Duration Period – When “Time Based” Recording is selected, all PPR Records are started and end on a predefined time schedule. Starting at the “Record Start Time” ending after the number of hours specified in “Time Period of Record”. When this record period ends PPR will automatically begin recording the next record. Process based recording is available in software version 8.2.0 and newer, process based recording should be used when the client prefers to start and stop a record period with the push of a button rather than a fixed time schedule.
 - Note: when Process Based Recording is used, the “Time Period of Record” is still applied as the maximum record duration.
 - Recommended Value – Based on application
 - Limits – Time Based (fixed) or Process Based (Variable)
- Record Start Time – First define the day of the week PPR Records will start, then define the hour and minute of day that a record period will typically begin
 - Recommended Value – Based on plants typical processing times, avoid creating a new record in the middle of a process when possible
 - Limits – Select day of week, from dropdown menus and the Hour and minute from onscreen buttons.
- Time Period of Record – The time duration of each record that PPR creates. This parameter is measured in hours and defines the X-Axis of all records created by PPR.
 - Recommended Value – Match the typical time period of the current process recorder.
 - **STLR Only:** Recommended Value – 12 Hour Maximum is typical for STLR applications though not required by PMO
 - Limits – Select via Dropdown
 - Note – all options are divisible by the number of hours in 1 week to ensure record time periods are uniform every week.
- Plant Info – Name – This text field name will appear on all records generated by PPR, similar to information that may be rubber stamped on paper records today.
 - Recommended Value – Enter full plant name that is expected to be seen by all parties who will review records created by this PPR
 - Limits – 50 Characters max.
- Plant Info – Address – This text field will appear on all records generated by PPR, similar to information that may be rubber stamped on paper records today.
 - Recommended Value – Enter full plant address that is expected to be seen by all parties who will review records created by this PPR
 - Limits – 100 Characters max.
- Plant Info – ID – This identification number will appear on all records generated by PPR, similar to information that may be rubber stamped on paper records today
 - Recommended Value – IMS/FDA or other regulatory ID number when applicable
 - Limits – 10 Characters max.

- Y Axis Major Divisions – Defines the total number of increments on the Y axis that appear with input scale labels. By default, Major Divisions appear on PPR records as a thick blue line.
 - Recommended Value – To ensure whole numbers are seen on Y-Axis scales, input a number divisible by the input range that will be recorded on record
 - Limits – Min: 1, Max: 60
- Y Axis Minor Divisions (per Major) – Defines the total number of increments on the Y axis that appear between each major division. By default, Minor Divisions appear on PPR records as a thin blue line.
 - Recommended Value – For most processes a value of 5 or 10 will provide adequate resolution of the y-axis scale
 - Limits – Min: 1, Max: 24
- X Axis Major Divisions – Defines the number of increments on the X axis that appear with time labels. By default, Major Divisions appear on PPR records as a thick blue line.
 - Recommended Value – Choosing a value that is divisible by the Record Time Period
 - Example: For a Record Time period of 12 hours, X Axis Major Divisions should be 12 or 24.
 - Limits – Min: 1, Max: 20
- X Axis Minor Divisions (per Major) – Defines the total number of increments on the x axis that appear between each major division. By default, Minor Divisions appear on PPR records as a thin blue line.
 - Recommended Value – If major divisions equate to 1 hour, 6 minor divisions will create divisions every 10 minutes, 4 minors will be every 15 minutes
 - Limits – Min: 1, Max: 60

5.4.2 Record Configuration

Each record created by PPR can be configured to include any combination of the configured inputs. Using the Record(n) configuration tab shown in Figure 75 within the Configure Recorder Menu each recorded input can be configured with unique trendline colors, scales, and labels.

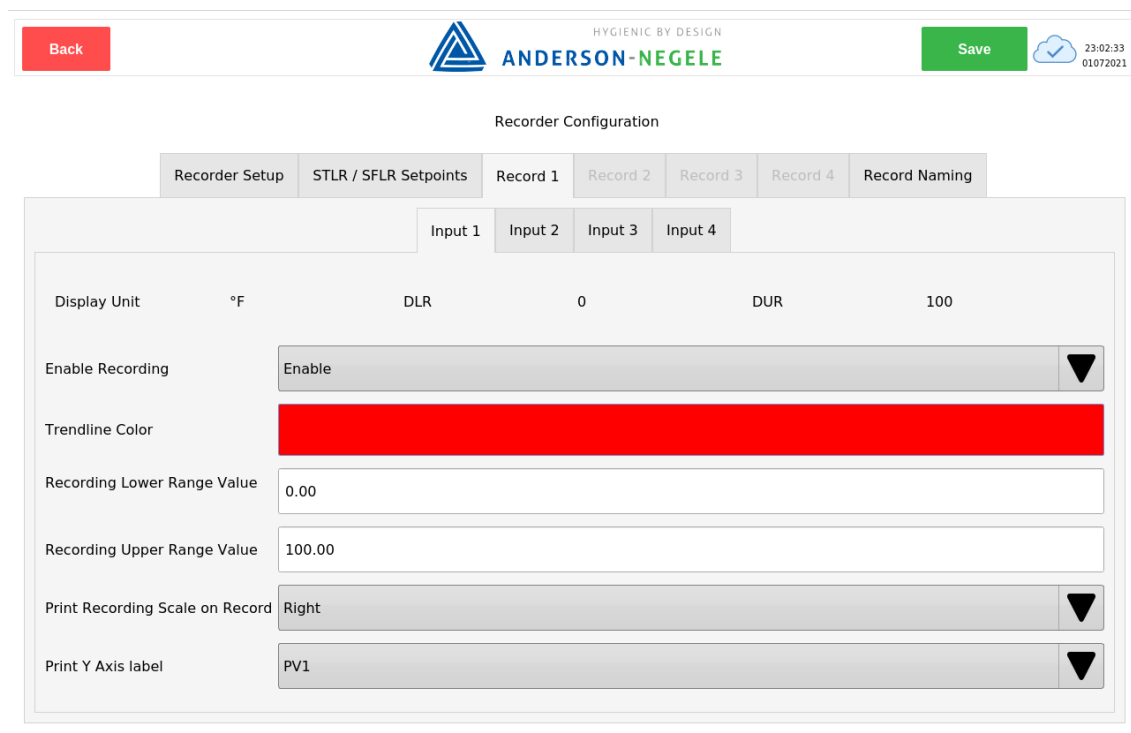

Figure 75: Record Configuration Tab

Record Configuration Parameters

- Enable Recording – Choose to enable or disable the recording of each input on this record.
- Trendline color – Select trendline color for the input being recorded. This color is also applied to the Y axis label when applicable.
 - Limits: Select from Dropdown list. Each enabled input on the same record must have a unique trendline color.
- Recording Lower Range Value: Lowest value of chart scale shown on this PPR record
- Recording Upper Range Value: Highest value of chart scale shown on this PPR record
- Print Recording Scale on Record: Choose to display the record scale on the Right or Left side of the PPR record.
- Print Y Axis Label: Choose to disable the Y axis label, print the input name, or print the input name and display unit

5.4.3 STLR / SFLR Setpoints (STLR and SFLR Configuration Only)

This entire section is only applicable for PPRs configured for STLR and SFLR applications. In SFLR control applications the PPR controls the SFLR Relay Output based on the Loss of Signal (low flow) Alarm and High Flow Alarm Set Points.

Back



HYGIENIC BY DESIGN
ANDERSON-NEGELE

Save

 22:47:14
01072021

Recorder Configuration

Recorder Setup

STLR / SFLR Setpoints

Record 1

Record 2

Record 3

Record 4

Record Naming

| | | |
|-------------------------|---|---------|
| Loss of Signal Alarm SP | <input style="width: 90%;" type="text" value="10"/> | pct |
| High Flow Alarm SP | <input style="width: 90%;" type="text" value="15"/> | pct |
| Relay Delay for CIP | <input style="width: 90%;" type="text" value="2"/> | Seconds |
| STLR SP Decimal Pos. | XX ▼ | |
| STLR SP Deadband | <input style="width: 90%;" type="text" value="1"/> | |
| STLR SP1 | <input style="width: 90%;" type="text" value="10"/> | °F |
| STLR SP2 | <input style="width: 90%;" type="text" value="6"/> | °F |
| STLR SP3 | <input style="width: 90%;" type="text" value="5"/> | °F |
| STLR SP4 | <input style="width: 90%;" type="text" value="4"/> | °F |
| STLR SP5 | <input style="width: 90%;" type="text" value="0"/> | °F |

Figure 76: STLR / SFLR Setpoint Configuration

- Loss of Signal Alarm SP – A low-flow or loss-of-signal alarm set point ensures that the analog flow meter input is actively being measured by PPR. This parameter is always configured in the SFLR Input Display units. (See “SFLR Relay Function” for additional information)
 - Recommended Value –5% of max. system flow rate.
 - Note: The approved value for his parameter will be specific to each pasteurizer system, contact regulatory agency for guidance when applicable.
 - Limits – Loss of Signal Alarm SP < High flow Alarm Setpoint
- High Flow Alarm SP: A High Flow Alarm set point ensures that all product is pasteurized for a proper amount of time or FDD is diverted. This parameter is always configured in the SFLR Input Display units. (See “SFLR Relay Function” for additional information)
 - Recommended Value – Set to the maximum approved flow rate for this SFLR application.
 - Note: The approved value for his parameter will be specific to each pasteurizer system, contact regulatory agency for guidance when applicable.
 - Limits – High Flow Alarm SP < SFLR Input Upper Range Value
- STLR SP Deadband – Dead band value to reduce relay chatter between STLR cut in temperature and Cut-out temperature. This value is added to the chosen STLR SP which must be reached before Cut-In is achievable. This parameter is always configured in the STLR Input Display units. (See “STLR Relay Function” for additional information)
 - Recommended Value – minimum of 1°F or 0.5°C
- STLR SP(n) – STLR Set points (SP) are equivalent to the Cut-out temperature when the STLR Relay will be inactivated. PPR can be configured with up to 16 unique setpoints.

This parameter is always configured in the STLR Input Display units. (See “STLR Relay Function” for additional information)

- Recommended Value – Specific to pasteurization each process. Unused STLR set points should be left blank or set to the STLR input Upper Range Limit (200°C or 392°F. Neither Blank nor URL Setpoints will be selectable from the PPR home screen during operation.

5.4.4 STLR Record Configuration - STLR Only

STLR Event Pen

The STLR Event Pen records the position of the FDD with the same time scale as the STLR input. Based on the sensing of the FDD described in Section 3.7 of this manual there are 4 possible positions for the FDD. Figure 77 below displays how the various states of the FDD are displayed on the home screen and recorded on the event pen. STLR Event pen recording is automatically enabled when the STLR input is configured to Enable Recording.

| STLR Relay Board Terminal 4 Voltage | STLR Relay Board Terminal 7 Voltage | HMI Display | Event Pen Recording |
|-------------------------------------|-------------------------------------|-----------------------------|---------------------|
| Same as L1 | n/a | Forward Flow | Forward Flow |
| n/a | Same as L1 | Diverted Flow | Diverted Flow |
| n/a | n/a | Valve Position Not Detected | Diverted Flow |
| Same as L1 | Same as L1 | Valve Position Error | Diverted Flow |

Figure 77: FDD Positions and Recording

STLR Setpoint

For STLR configuration Input 2 is automatically recorded as the active STLR Setpoint **not** the measured STLR input 2 value. Recording Upper Range Value and Recording Lower Range Value must be configured to meet recording range requirements of the PMO.

5.4.5 SFLR Record Configuration

SFLR Event Pen

When configured the SFLR alarm set points will automatically drive an SFLR event Pen which records as In Range or Out of Range depending on the current SFLR measured input value. SFLR Event pen recording is automatically enabled when the SFLR input is configured to Enable Recording. The Relay Action behavior and event pen recording behavior can be seen in Figure 78 below.

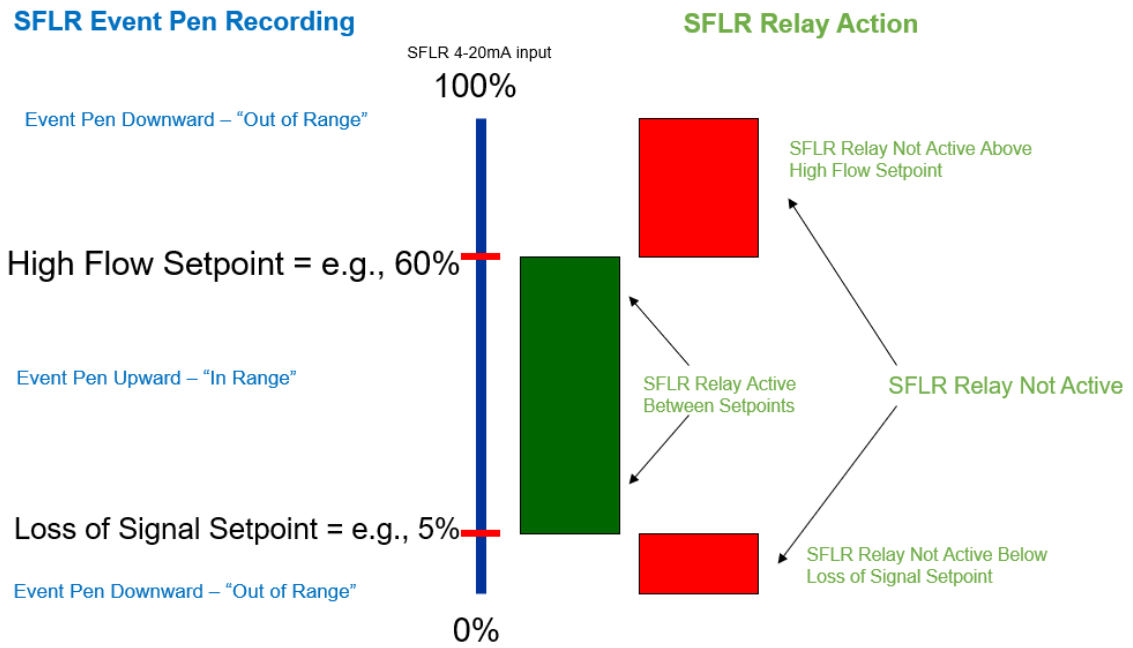

Figure 78: SFLR Relay and Event Pen Action

5.4.6 Record Naming Convention

PPR Record Name

Each record created by the PPR is automatically assigned a name per the following the convention. Once the record is created this name cannot be changed.

Record Name Prefix_Record Start Date_Record Start Time_Record Number.

Record Name Variables Defined

- Record Name Prefix – User configurable text that is applied to each record name. To change this parameter go to Recorder Configuration, Record Naming, Record Name Prefix. As seen in Figure 79 below Defined Choose to enable or disable the recording of each input on this record.
 - Limits – 20 characters max. Underscore, “_” is the only special character or symbol allowed

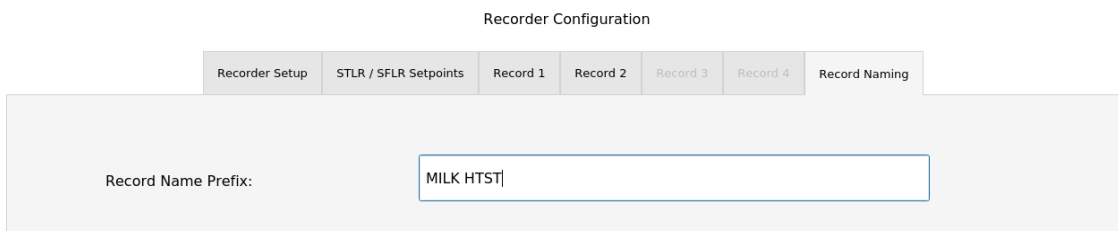

Figure 79: Record Name Prefix

- Record Start Date – Date of the record start period, shown in the format YYYY_MM_DD

- Record Start Time – Time of the record start period, shown in the format HH_MM_SXXM
- Record Number – The PPR record number created by that PPR.
 - Example: If the PPR creates 2 records per defined time period ..._Rec1 & ..._Rec2 would both be created

Example of Record Naming

In this example the PPR's Record Name Prefix is "Milk HTST", the record period started on April 21st, 2022 at 1:00:00am.

The PPR produces a record named: MILK HTST_2022_04_21_01_00_00AM_Rec1

5.4.7 Annotations Setup

Annotations Setup

This tab of the Recorder Configuration Menu shown in Figure 80 below has multiple options that effect when and how annotations are displayed on the records generated by the PPR.

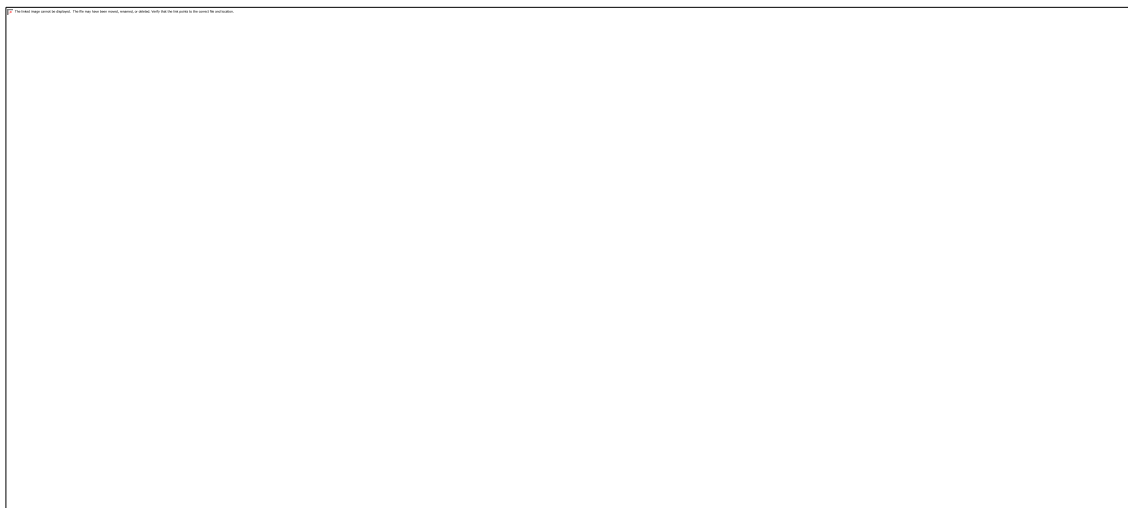

Figure 80: Annotation Setup Options

- Print input range error on records – This parameter controls if the PPR will include input range error annotations on the records it generates. When the box is checked the feature is enabled and input range errors described in Section 5.3.1 of the manual will be included on the record each time the error condition exists.
- Print date and time when annotation was added – This parameter controls if the PPR will automatically include a time and date stamp indicating when each annotation is added to the record, as described in Section 2.1.3.1.

5.5 System Info/Annotation Configuration

The System Information parameters that are displayed on the PPR home screen seen in Figure 43 are configurable in the "System Info/Annotation Configuration Menu. The System Information configuration is done on the leftmost tabs of the configuration menu (shown in Figure 81) while the Predefined "Add Notes" annotations is the "Annotation" tab of this menu (Shown in Figure 82).

These predefined annotation lists are can be configured by any user with access level = 1 by following these steps;

1. Press the *Menu* button from the home screen
2. Press System Info/Annotation Configuration
3. Press Unlock
4. Enter valid user credentials.
5. To edit, delete or add a “System Info Name” select the white box to the right of “System Info Name”
 - a. To edit, type new information using onscreen keyboard and press submit
 - b. To delete, press clear using onscreen keyboard and press submit
 - c. To add new, press the blank “System Info Name” field, then follow steps in “a.”
6. To edit, delete or add new text to an item on the dropdown list select the field to edit
 - a. To edit, type new information using onscreen keyboard and press submit
 - b. To delete, press clear using onscreen keyboard and press submit
 - c. To add new, press a blank system information field, then follow steps in “a.”
7. Press Save on each tab of the configuration menu after changes are made

Back

HYGIENIC BY DESIGN
ANDERSON-NEGELE

Save 21:55:42
02/22/2021

System Info/Annotation Configuration

Product Source Destination Annotations

System Info Name Product

test

test3

Figure 81: System Information Configuration

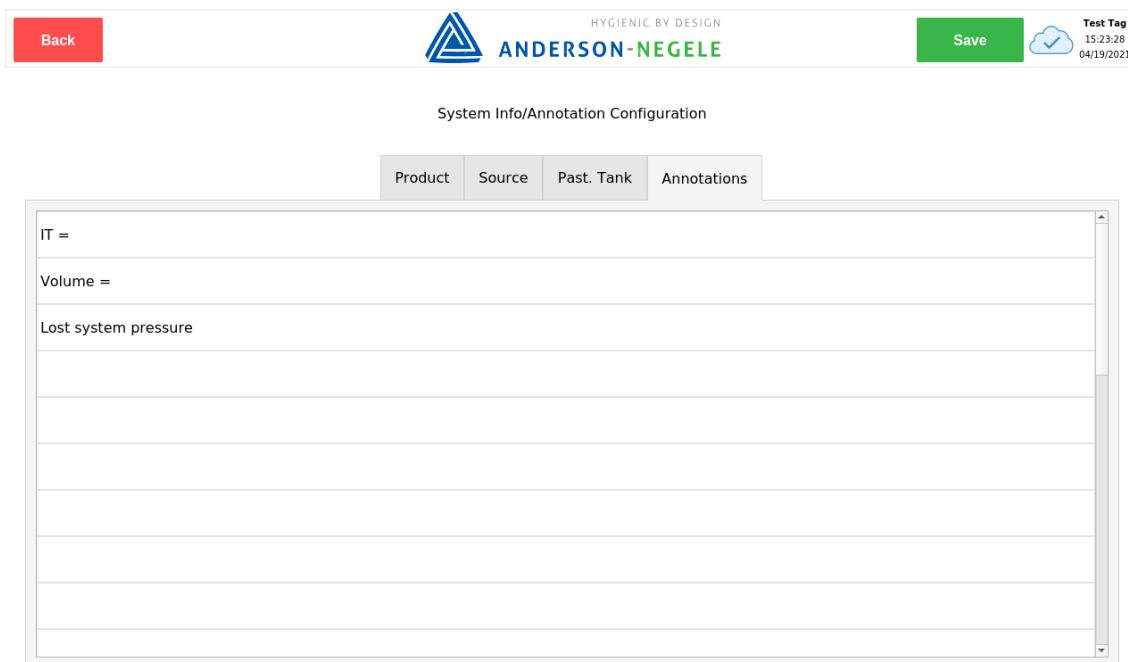

Figure 82: Configuration "Add Notes" Annotations

5.6 Output Configuration

PPR allows for mA retransmission of any measured input channel. When entering the Output configuration menu, a tab for each output channel will be displayed bearing the output channel name as seen in Figure 83 below.

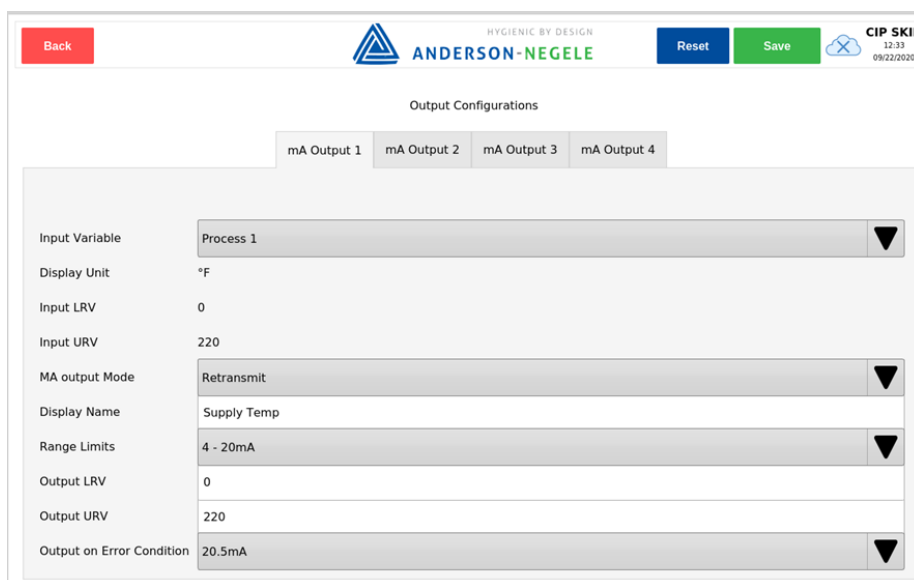

Figure 83: Output Configuration Menu

Configurable Output Parameters

- Input Variable – Select which input is used for this output channel configuration.
- Display Unit – Read only field indicating the selected input Variable’s configured display units.
- Input LRV – Read only field indicating the selected input Variable’s configured Lower Range Value.
- Input URV – Read only field indicating the selected input Variable’s configured Upper Range Value.
- mA Output Mode: The function of the mA output channel. User can select Retransmit, OFF
- Display Name: HMI display name for the mA output channel.
- Range Limits : The range of the output Channel controlled by PPR, User can select ; 4-20mA or 0-20mA range
- Output LRV: Scaled output value at lower mA range specified
- Output URV: Scaled output value at 20 mA
- Output on Error Condition: mA value controlled by PPR when the Input Variable selected is in an error state.
 - Limits – Selectable dropdown list.

The mA output channels on PPR can be configured by any user with access level = 1 by following these steps;

1. Press the *Menu* button from the home screen
2. Press Configure Outputs
3. Press Unlock
4. Enter valid user credentials.
5. Click on tab corresponding to output # and change parameters as needed.
6. Make desired changes
7. Press Save on each tab of the configuration menu after changes are made

5.7 Alarm Configuration

PPR allows for the configuration of multiple process-based alarms through the HMI. The alarm configuration menu is also how the optional relays outputs are configured. The status of all alarms is available at any time on the status screen of the Alarm configuration menu, Seen in Figure 84. The Alarm Status tab allows a user to see the high-level configuration details of all alarms at one time. All other alarm tabs show the unique configuration of a single alarm.

Alarms 1-4 will automatically correspond to relays 1-4 if the PPR is assembled with the optional relay outputs.

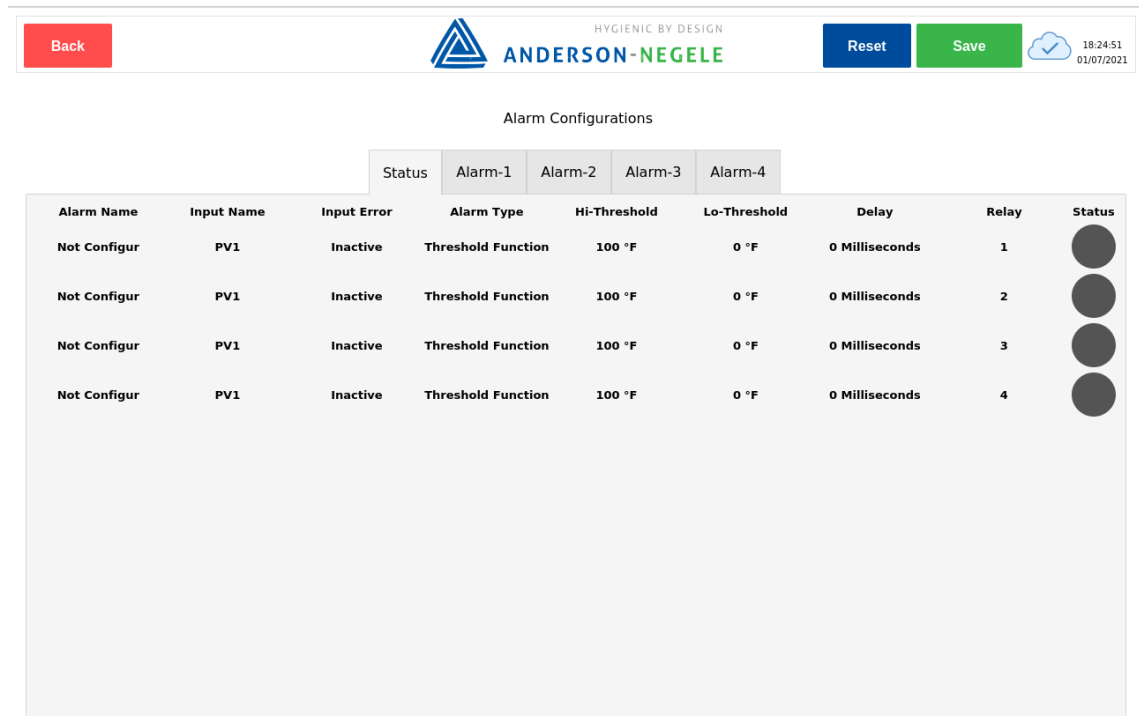

Figure 84: Alarm Status Screen

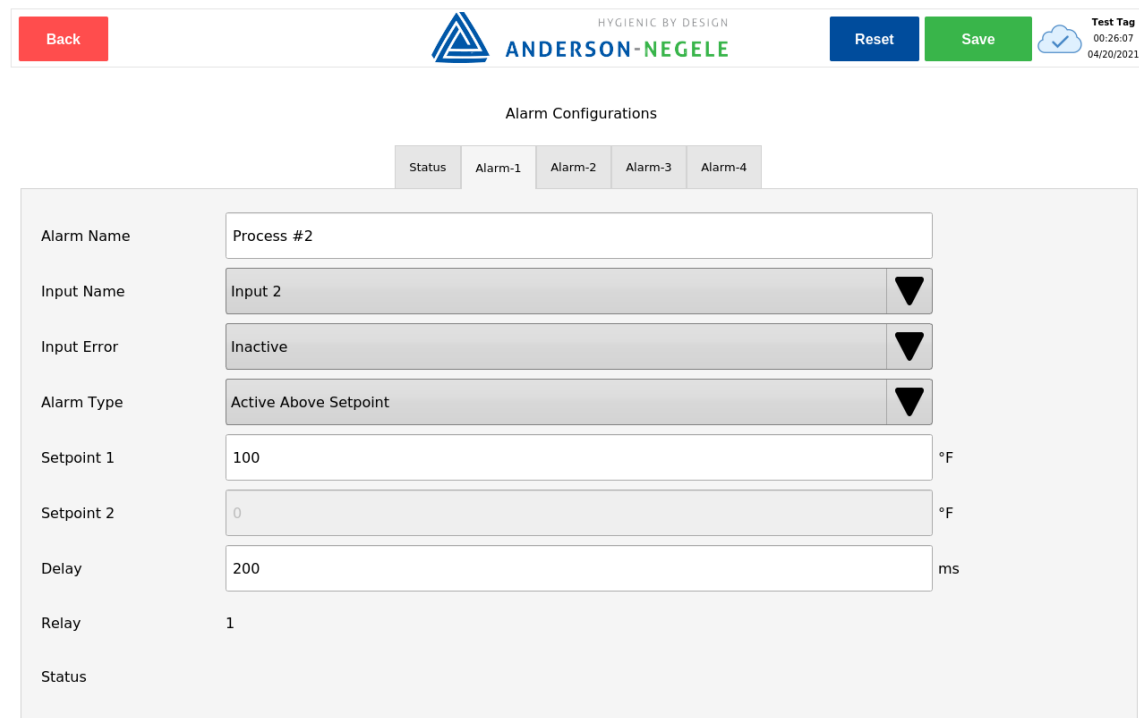

Figure 85: Alarm Configuration Menu

Alarm configuration parameters

- Alarm Name – Name for the process-based alarm
 - Limits – 12 Characters

- Input Name – Choose from any of the configured inputs to associate a process-based alarm with that input.
 - Limits – Select via dropdown
- Input error – The condition the alarm will default to if an input error occurs on the selected “Input Name”
- Alarm Type – The mode in which the alarm will function (Samples shown in Figure 86)
 - Active Above Setpoint – The alarm will activate when the process input > Setpoint 1. Setpoint 2 is not used with this Alarm Type.
 - Active Below Setpoint – The alarm will deactivate when the process input > Setpoint 1. Setpoint 2 is not used with this Alarm Type.
 - Active Inside Window – The alarm will activate when the following condition is true; Setpoint 1 < Measured input Value < Setpoint 2
 - Limits – Setpoint 1 ≠ Setpoint 2
 - Active Outside Window – The alarm will deactivate when the following condition is true; Setpoint 1 < Measured input Value < Setpoint 2
 - Limits – Setpoint 1 ≠ Setpoint 2
- Setpoint 1 – Value associated with the process alarm; this value is always entered in the same display units as the selected Alarm Input Channel.
- Setpoint 2 – Value associated with the process alarm; this value is always entered in the same display units as the selected Alarm Input Channel.
- Delay – Time delay associated with the process alarm, entered in milliseconds. This time delay slows the change of alarm states in both directions.
 - Limits – Min: 1ms, Max: 1,000,000ms
- Relay – The Relay number associated with the process alarm. Note: These are fixed values, the PPR user cannot configure or choose the relay number.
- Status: The status icon indicates if the alarm is active or inactive
 - Green Alarm Status: Alarm is active
 - Red Alarm Status: Alarm is inactive
 - Gray/Black Status: Alarm is not configured

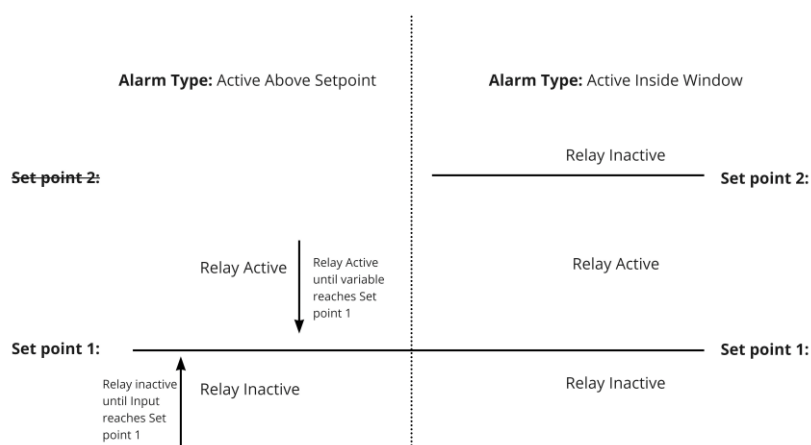

Figure 86: Alarm Type Function Diagram

The Alarms on PPR can be configured by any user with access level = 1 by following these steps;

1. Press the *Menu* button from the home screen
2. Press Configure Alarms
3. Press Unlock
4. Enter valid user credentials.
5. Click on tab corresponding to Alarm Number that needs to be configured.
6. Make desired changes
7. Press Save on each tab of the configuration menu after changes are made

6 Calibration

In some regulatory applications the plant is responsible for maintaining a log of any external changes to the recording device (including Calibrations). PPR will automatically capture calibration changes, with the name of user time and date in its system Activity log and on PPR Records.

Performing an input calibration is recommended following any input configuration change or Input module (card) changes.

Only users with Access Level = 1 in their employee profile within Legendary™ will be able to perform calibrations.

Calibration changes may be inhibited by the Run / Program Jumper, see Section 2.1.5 of this Manual for additional information.

6.1 Input Calibration

PPR allows the users to perform a single or two-point calibrations on each input channel. This calibration procedure should only be performed when the input is at steady state, e.g. in a stable temperature calibration bath. To perform an input calibration, follow these steps.

1. Press the *Menu* button from the home screen
2. Press *Calibrate Inputs/Outputs*
3. Enter valid user credentials.
4. Select the *Input Number* tab of Input you would like to calibrate as seen in Figure 87: Input Calibration below.
5. Choose to perform the calibration in Display Units or Native units. Below the input tabs there is a section of read only information that displays the input configuration details including the Display units, native units and ranges for each, See example in Figure 87 below.

Adjustment 1: Used for calibration on the low end of the Input Range

6. Wait for the input to reach a stable reference value
7. Press *Actual Value*, the current measured value for that input will appear on the right side of the *Actual Value* button
8. Click the white field on the right of Reference Value

9. Use the Keypad to Input the Reference Value. The Reference Value is the known value of the calibration source. e.g. the temperature of the steady state calibration bath
10. Continue to Step 11 if desired, or press save.

Adjustment 2: Used for calibration on the high end of the Input Range

11. Wait for the input to reach a stable reference value on the high end of the input range
12. Repeat steps 6-10

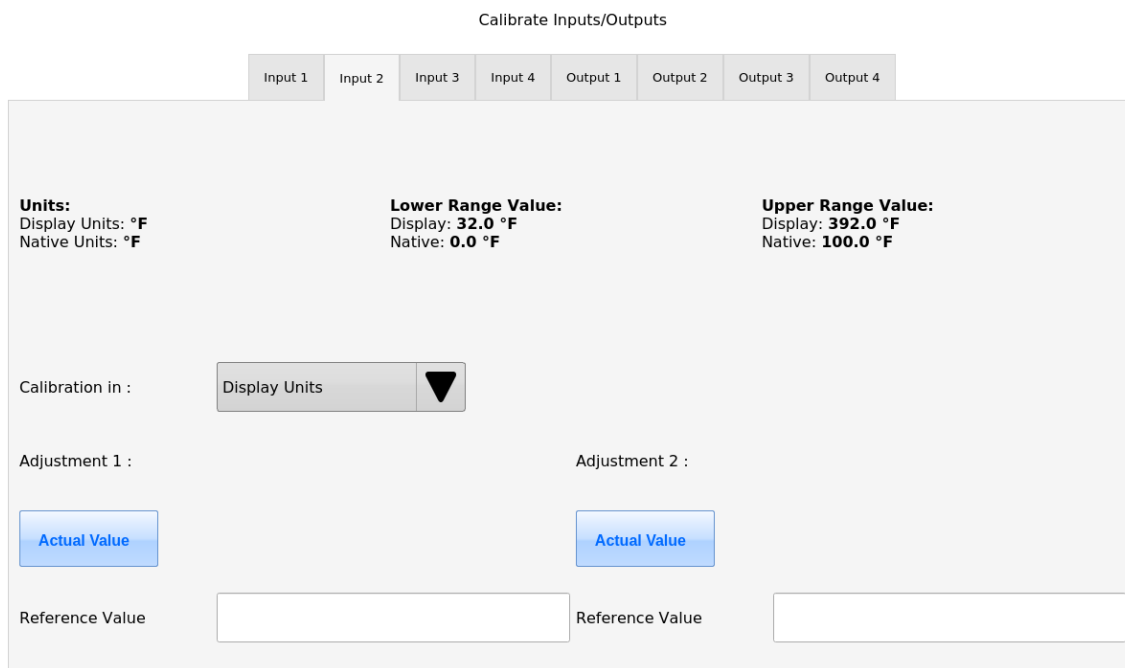

Figure 87: Input Calibration

STLR Only

In STLR applications, calibrating both Inputs 1 and 2 are required to ensure that the calibration does not introduce a sensor imbalance.

6.2 mA Output Calibration

PPR allows the users to perform a single or two-point calibrations on each output channel. This calibration procedure should only be performed when the mA output can be connected to an accurate reference instrument (to input Actual Value). Performing an output calibration will temporarily disable all output channels.

The Output Calibration procedure allows the user to simulate mA output values at a steady state and measure the output values with the reference instrument connected to the output channel being calibrated.

To perform an input calibration, follow these steps;

1. Press the *Menu* button from the home screen
2. Press *Calibrate Inputs/Outputs*
3. Enter valid user credentials.

4. Select the tab of the Output you would like to calibrate
5. Press light blue *Output 4mA* button to begin simulating 4mA on the selected output channel. Button will turn Green when actively simulating a mA output value.
6. Click the white field on the right of Reference Value Actual Value (mA) text
7. Use the Keypad to input the Actual Value (mA) that is currently being measured by the reference instrument.
8. Press light blue *Output 20mA* button to begin simulating 20mA on the selected output channel. Button will turn Green when actively simulating a mA output value.
9. Click the white field on the right of Reference Value Actual Value (mA) text (under the *Output 20mA* button).
10. Use the Keypad to input the Actual Value (mA) that is currently being measured by the reference instrument.
Actual measured mA value will be shown in *Actual Value (mA)* textbox
11. Press Save

Calibrate Inputs/Outputs

| Input 1 | Input 2 | Input 3 | Input 4 | Output 1 | Output 2 | Output 3 | Output 4 |
|--|---------|---------|---------|--|----------|----------|----------|
| Calibrate 4mA | | | | Calibrate 20mA | | | |
| <div style="background-color: green; color: white; padding: 2px; display: inline-block;">Output 4mA</div> Active | | | | <div style="border: 1px solid blue; padding: 2px; display: inline-block;">Output 20mA</div> Inactive | | | |
| Actual Value (mA) <input style="width: 100%;" type="text"/> | | | | Actual Value (mA) <input style="width: 100%;" type="text"/> | | | |

Figure 88: Output Calibration Procedure

7 Troubleshooting

| No. | Symptom/Observation | Corrective Action |
|-----|---------------------------------------|--|
| 1 | Process value reading displays Error. | Check system activity log for additional information on that channels input error |
| 2 | HMI is not responding to touch | Ensure USB cable between PPR SOM and PPR HMI is connected. Try disconnecting and reconnecting USB cable to SOM if problem persists. |
| 3 | Cannot see my name in PPR user list. | Contact Plant Legendary™ administrator, ensure you are set to active employee for that equipment level or higher. Wait 15 minutes for sync with Legendary™. Must see check mark on cloud status. |

| | | |
|----|--|--|
| 4 | Cannot see any names in PPR user list. | Ensure there is cloud connectivity (check mark on cloud status). Contact Plant Legendary™ administrator, ensure there are active employees for that equipment level or higher. |
| 5 | Cannot approve the chart. | Temporary chart? Role in workflow? |
| 6 | Charts are not uploading to Legendary. | Cloud icon? recorder setup? Date/time conflict? |
| 7 | I was just added as a Legendary User, and I cannot see my name in user list. | Ensure active status of Legendary™ connection, Wait 15 minutes for sync between PPR and Legendary™ Press the sync user button in the |
| 8 | Cannot login using my pin code. | If the PIN being used is potentially incorrect or forgotten? Ask plant Legendary™ admin to reset |
| 9 | Cannot configure/calibrate recorder. | Verify the Run/Program jumper position (J9) Ask plant Legendary™ admin to change User access level to = 1 |
| 10 | Cannot see trendline(s) in the digital chart. | Is the incoming input active? Verify the input scale covers PV operation range? |
| 11 | Display is blank (does not power on). | Verify 24V supply. Verify connections of cables from PPR SoM to display. |
| 12 | Time reset to 1970 | Replace the cr2032 3VDC battery, reconfigure time on PPR |
| | | |
| | | |
| | | |
| | | |