



Pneumatically operated 2-way Globe Control Valve

- Excellent control characteristics
- High cycle life and maintenance-free operation
- Flow optimised body in stainless steel
- Several K_{VS} value per port size due to removable valve seats
- Control units can be mounted directly without external tubing

Product variants described in the data sheet may differ from the product presentation and description.

Can be combined with

	Type 8692 ▶ Digital electro-pneumatic positioner for integrated mounting on process control valves
	Type 8694 ▶ Digital electropneumatic positioner for the integrated mounting on process control valves
	Type 8696 ▶ Digital electropneumatic positioner for the integrated mounting on process control valves
	Type 8693 ▶ Digital electro-pneumatic process controller for integrated mounting on process control valves
	Type 8792 ▶ Digital electro-pneumatic positioner: SideControl
	Type 8791 ▶ Digital electropneumatic Positioner SideControl
	Type 8793 ▶ Digital electro-pneumatic Process Controller, SideControl

Type description

In line with Bürkert's philosophy the construction of the type 2301 globe valve fulfils tough criteria for process environments. Unrivalled cycle life and sealing integrity is guaranteed by the proven self adjusting spindle packing with exchangeable V-seals. Each globe valve body can be fitted with up to five sizes of trim sets.

These parabolic trims provide a reliable and repeatable characteristic to vary the flow. The control cones are available in either stainless steel or with a durable PTFE seal or PEEK seal for tight shut-off. Leakage class III, IV or VI are available. The design enables the easy integration of automation modules whether they are digital electropneumatic positioner or process controller.

The fully integrated system has a compact and smooth design, integrated pneumatic lines, IP65/67 protection class and superior chemical resistance.

Table of contents

1. General technical data	3
2. Product versions	4
2.1. 2301 ELEMENT	4
2.2. 2712 CLASSIC	4
3. Circuit functions	4
4. Approvals	5
5. Materials	5
5.1. Chemical Resistance Chart – Bürkert resistApp	5
5.2. Material specifications	6
2301 ELEMENT	6
2712 CLASSIC	6
6. Dimensions	7
6.1. Actuator	7
Valve system Continuous ELEMENT	8
6.2. Body with flange connection	9
6.3. Body with threaded connection	10
6.4. Body with welded connection	11
6.5. Body with clamp connection	12
7. Performance specifications	13
7.1. Fluidic data	13
Flow characteristics	13
Overview of fluidic data for flow under seat (for gases, steam and liquids)	13
Pilot pressure diagram with flow direction below seat (Control function B)	15
7.2. Operating limits	16
Operating limits for medium temperature and operating pressure	16
Operating limits for ambient and medium temperature	17
Operating limits for seat seal	17
Operating limits for optional versions	18
8. Product accessories	18
9. Networking and combination with other Bürkert products	22
10. Ordering information	24
10.1. Bürkert eShop – Easy ordering and quick delivery	24
10.2. Bürkert product filter	24
10.3. Ordering chart flange connection	25
Valve with flow direction below seat	25
10.4. Ordering chart threaded connection	28
Valve with flow direction below seat	28
10.5. Ordering chart welded connection	31
Valve with flow direction below seat	31
10.6. Ordering chart clamp connection	34
Valve with flow direction below seat	34

1. General technical data

Product properties	
Dimensions	Detailed information can be found in chapter "6. Dimensions" on page 7.
Material	Detailed information can be found in chapter "5. Materials" on page 5.
Design	Globe control valve
Nominal diameter	DN 10...DN 100, NPS ¾...NPS 4
Safety setting in case of power failure	Normally closed (control function A), normally open (control function B)
Flow direction	Flow to open (below seat)
Performance data	
Operating pressure	0 bar(g) ... 25 bar(g), vacuum version up to -0.9 bar(g) (Option) see "7.1. Fluidic data" on page 13
Nominal pressure	PN 25 (DIN EN 1333), Class 150 (DIN EN 1759)
Seat leakage acc. to DIN EN 60534-4:2006	Leakage class III and IV for stainless steel Leakage class VI for PTFE and PEEK (see "7.1. Fluidic data" on page 13)
K _v value	0.1 m ³ /h...140 m ³ /h, see "7.1. Fluidic data" on page 13
Operating characteristic	Linear or equal percentage
Theoretical rangeability	Up to 50:1
Medium data	
Medium	Steam, water, neutral gases, alcohol, oils, fuels, hydraulic fluids, salt solution, alkali solutions, organic solvents, for fuel gases of category I, II and III acc. to Gas Appliances Regulation (EU) 2016/426 and oxygen
Medium temperature	-40 °C...230 °C, see "7.2. Operating limits" on page 16
Viscosity	Max. 600 mm ² /s
Control medium	Air, neutral gases
Process/Port connection & communication	
Port connection²⁾	
Flange connection	DIN EN 1092 - 1 ANSI B 16.5 JIS 10K
Threaded connection	G (DIN ISO 228 - 1) NPT (ASME B1.20.1) Rc (ISO 7 - 1)
Welded connection	DIN EN ISO 1127 / ISO 4200 / DIN11866 B DIN 11850 2 / DIN 11866 A ASME BPE / DIN 11866 C SMS 3008
Clamp connection	DIN 32676 B (pipe ISO 4200) DIN 32676 A (pipe DIN 11850 2) ASME BPE
Approvals and certificates	
Conformity	Food contact 1935/2004(EG), FDA Drinking water Pressure equipment directive Gas Appliances Regulation Machinery Directive
Approval	Explosion proof ATEX / IECex
Material certificate	2.2, 3.1
Environment and installation	
Degree of protection	IP65/67
Installation position	As required, preferably with actuator upright

2. Product versions

2.1. 2301 ELEMENT

Product properties	
Nominal diameter	DN 10...100
Actuator size	50 mm (D), 70 mm (M), 90 mm (N), 130 mm (P)
Performance data	
Maximum pilot pressure	5.6...7 bar(g)
Medium data	
Medium temperature	-40 °C...230 °C, see "7.2. Operating limits" on page 16
Environment and installation	
Ambient temperature	-10...80 °C (for positioner or process controller Type 8791/8792/8793) -10...55 °C (for positioner or process controller Type 8692/8693/8694) See "Operating limits for ambient and medium temperature" on page 17





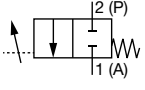
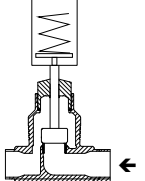
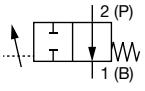
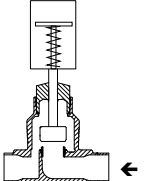

2.2. 2712 CLASSIC

Product properties	
Nominal diameter	DN 65...100
Actuator size	225 mm (L)
Performance data	
Maximum pilot pressure	5.0...6.0 bar(g)
Medium data	
Medium temperature	-40 °C...180 °C, see "7.2. Operating limits" on page 16
Environment and installation	
Ambient temperature	-10...50 °C

3. Circuit functions

Control function (CF)	Description	
Flow direction below seat for fluids, steam and gases		
	CF: A, pneumatically operated control valve 2/2-way Flow direction below seat Normally closed by spring force	
	CF: B, pneumatically operated control valve 2/2-way Flow direction below seat Normally open by spring force	

4. Approvals

Approval	Description
	Food produce contact Materials in contact with the medium conform to EC regulation 1935/2004 (standard Type 2301, option Type 2712) Materials in contact with the medium conform to FDA (option)
	Drinking water Suitable for use with drinking water for medium temperatures up to 85 °C in accordance with the Drinking Water Ordinance §17 and the assessment principles of the Federal Environment Agency (option).
	Oxygen Suitable for use with gaseous oxygen for medium temperature up to 60 °C and operating pressure up to 25 bar(g) (option)
 	Explosion proof As category 2 device suitable for zone 1/21 and zone 2/22 (option) ATEX: II 2G Ex h IIC T4 Gb II 2D Ex h IIIC T135 °C Db IECEX: Ex h IIC T4 Gb Ex h IIIC T135 °C Db
	Fuel gases Approval according to the European Gas Appliances Regulation (EU) 2016/426, DVGW DIN EN 161 and DIN EN 16678, Class D, suitable for medium temperature 0 °C...+160 °C, ambient temperature -10...+60 °C and operating pressures 0...25 bar(g) (option)

5. Materials

5.1. Chemical Resistance Chart – Bürkert resistApp

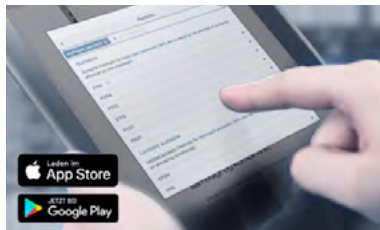

Bürkert resistApp – Chemical Resistance Chart

You want to ensure the reliability and durability of the materials in your individual application case? Verify your combination of media and materials on our website or in our resistApp.

[Start Chemical Resistance Check](#)

5.2. Material specifications

2301 ELEMENT

Note:

The Type 2301 globe control valve is supplied with different connection ports (flange, threaded, welded and clamp). These connections are not shown in the picture. They correspond to the material of the valve body.

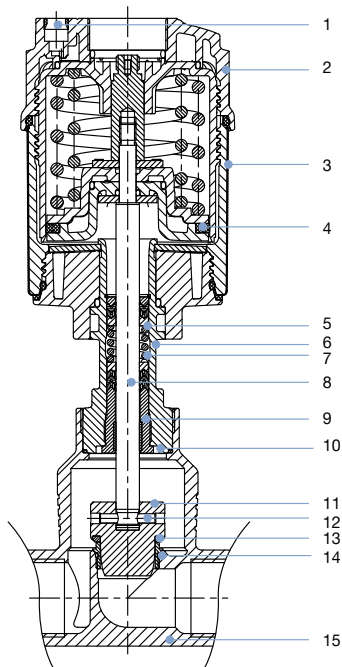

No.	Element	Material
1	Pilot air ports	Push-in connector PP
2	Actuator	PPS
3	Cover	Stainless steel 1.4561 (316Ti)
4	Piston seal	FKM
5	Spring	Stainless steel 1.4310
6	Pipe	Stainless steel 1.4401 (316)
7	Spindle sealing	PTFE V-Rings (filled), with spring compensation
8	Spindle	Stainless steel 1.4401 (316)/1.4404 (316L)
9	Spindle guide	Stainless steel 1.4404 (316L), PTFE filled
10	Body seal	Graphite or PTFE
11	Control cone	Stainless steel 1.4571 (optionally hardened)
12	Spring straight pin	Stainless steel 1.4310
13	Seat seal	Stainless steel 1.4571 (optionally hardened), PTFE or PEEK
14	Valve seat with O-Ring	Stainless steel 1.4571, EPDM
15	Valve body	Stainless steel 316L / CF3M

2712 CLASSIC

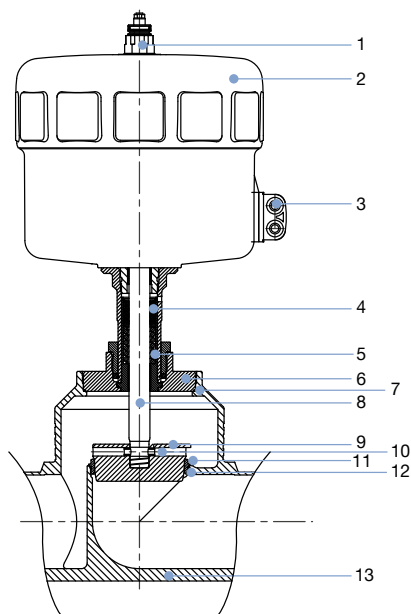

No..	Element	Material
1	Adapter	Stainless steel 1.4305
2	Actuator	PA Polyamide
3	Pilot air ports	Stainless steel 1.4305
4	Spindle sealing	PTFE V-Rings (filled), with spring compensation
5	Spring	Stainless steel 1.4568
6	Nipple	Stainless steel 1.4404
7	Body seal	Graphite or PTFE
8	Spindle	Stainless steel 1.4404
9	Control cone	Stainless steel 1.4571 (optionally hardened)
10	Spring straight pin	Stainless steel 1.4310
11	Seat seal	Stainless steel 1.4571 (optionally hardened), PTFE or PEEK
12	Valve seat with O-Ring	Stainless steel 1.4571 (optionally hardened), EPDM
13	Valve body	Stainless steel 316L / CF3M

DTS 1000112693 EN Version: AF Status: RL (released | freigegeben | valide) printed: 09.03.2023

6. Dimensions

6.1. Actuator

Note:

Dimensions in mm, unless otherwise stated

Continuous ELEMENT Type 2301 valve

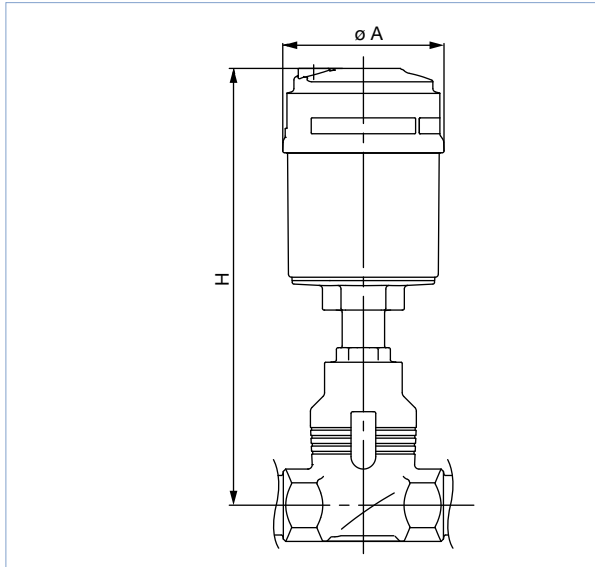

Continuous ELEMENT Type 2712 valve

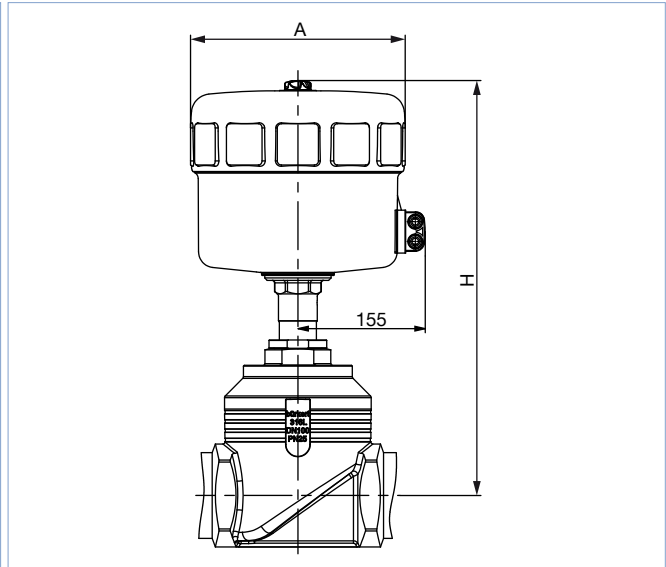

Nominal diameter (pipe)		Actuator size	$\varnothing A$	H
DN	NPS			
10	3/8	50(D)	64.5	226
		70(M)	91	239
15	1/2	50(D)	64.5	226
		70(M)	91	239
20	3/4	50(D)	64.5	232
		70(M)	91	245
25	1	50(D)	64.5	235
		70(M)	91	248
		90(N)	120	301
32	1 1/4	90(N)	120	329
		130(P)	159	381
40	1 1/2	90(N)	120	334
		130(P)	159	386
50	2	90(N)	120	340
		130(P)	159	392
65	2 1/2	130(P)	159	446
		225(L)	261	474
80	3	130(P)	159	454
		225(L)	261	482
100	4	130(P)	159	464
		225(L)	261	492

DTS 1000112693 EN Version: AF Status: RL (released | freigegeben | validé) printed: 09.03.2023

Valve system Continuous ELEMENT

Note:

- Dimensions in mm, unless otherwise stated
- Please note actuator size A in table “6.1. Actuator” on page 7

With positioner
TopControl, **Type 8692**
or
with process controller
TopControl, **Type 8693**

With positioner
TopControl Basic,
Type 8694

With positioner
TopControl Basic,
Type 8696

With remote positioner SideControl, **Type 8792**
or
with remote process controller
SideControl,
Type 8793

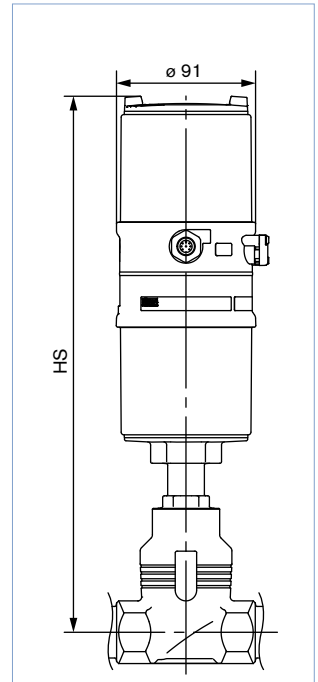
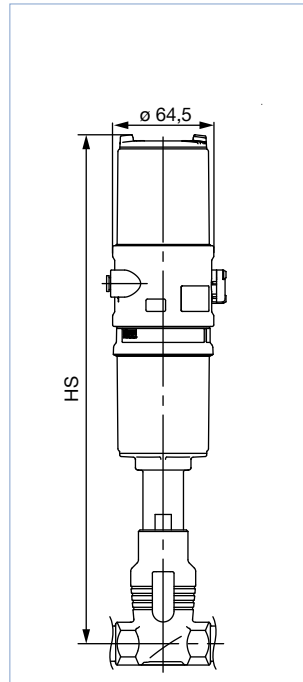
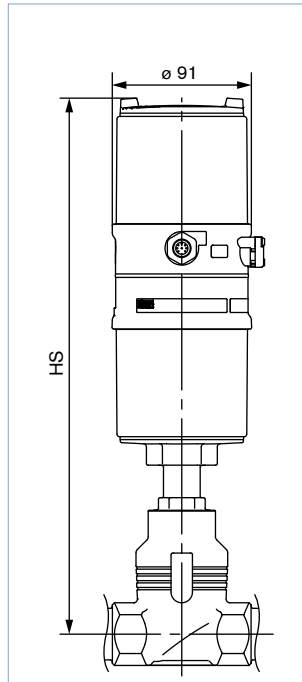
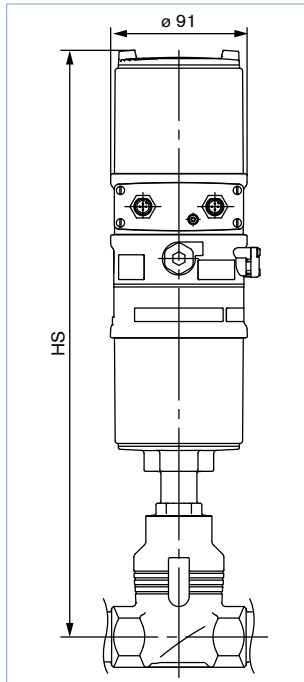

Nominal diameter (pipe)		Actuator size	HS with		
DN	NPS		8692 or 8693	8694 or 8696	8792 or 8793
10	3/8	50(D)	–	329	–
		70(M)	383	342	342
15	1/2	50(D)	–	329	–
		70(M)	383	342	342
20	3/4	50(D)	–	335	–
		70(M)	389	348	348
25	1	50(D)	–	342	–
		70(M)	392	351	351
		90(N)	445	404	404
32	1 1/4	90(N)	473	432	432
		130(P)	525	484	484
40	1 1/2	90(N)	478	437	437
		130(P)	530	489	489
50	2	90(N)	484	443	443
		130(P)	536	495	495
65	2 1/2	130(P)	590	549	549
		225(L)	629	586	586
80	3	130(P)	598	557	557
		225(L)	637	594	594
100	4	130(P)	608	567	567
		225(L)	647	604	604

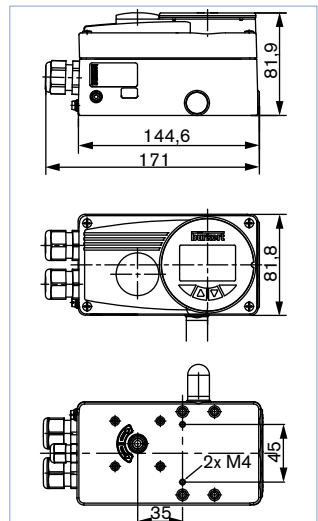

DTS 1000112693 EN Version: AF Status: RL (released | freigegeben | valide) printed: 09.03.2023

6.2. Body with flange connection

Note:

Dimensions in mm, unless otherwise stated

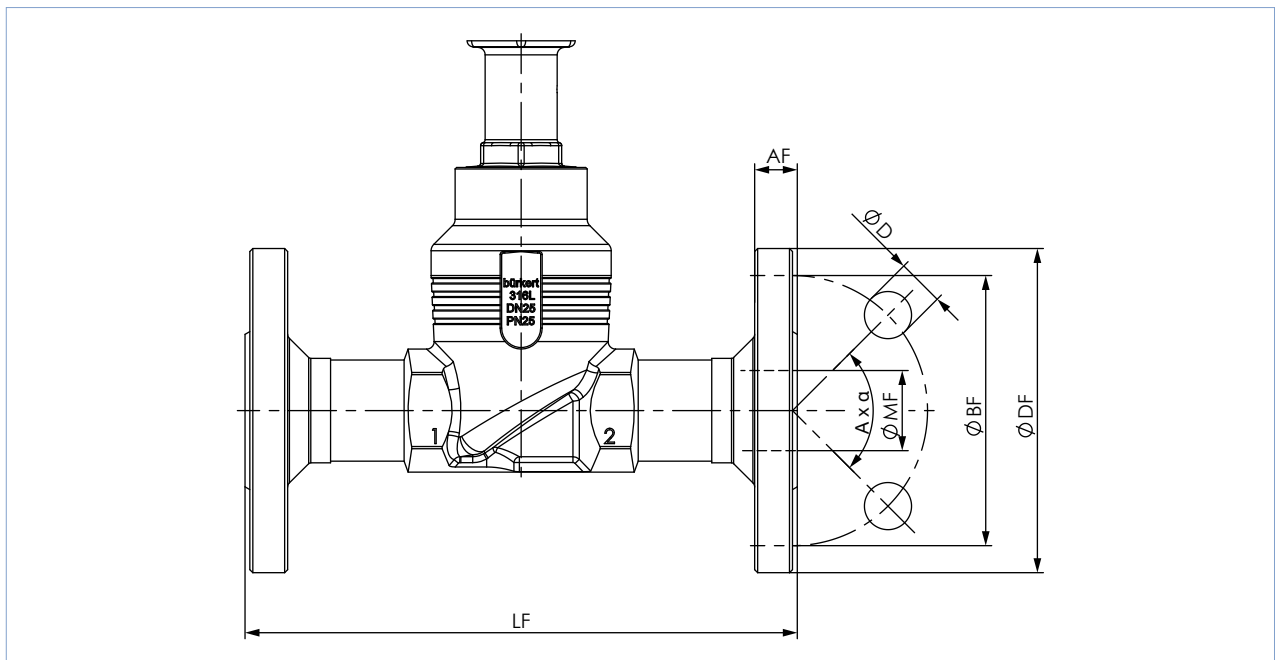

Nominal diameter (pipe)	DIN EN 1092 PN 25 FTF 1 acc. to DIN EN 558-1							JIS 10K FTF 10 acc. to DIN EN 558-2							
	DN	Ø DF	LF	Ø BF	AF	Ø D	A x α	Ø MF	Ø DF	LF	Ø BF	AF	Ø D	A x α	Ø MF
10	90	130	60	16	14	4 x 90°	13.6	-	-	-	-	-	-	-	-
15	95	130	65	16	14	4 x 90°	18.1	95	108	70	12	15	4 x 90°	18.1	
20	105	150	75	18	14	4 x 90°	23.7	100	117	75	14	15	4 x 90°	23.7	
25	115	160	85	18	14	4 x 90°	29.7	125	127	90	14	19	4 x 90°	29.7	
32	140	180	100	18	18	4 x 90°	38.4	135	140	100	16	19	4 x 90°	38.4	
40	150	200	110	18	18	4 x 90°	44.3	140	165	105	16	19	4 x 90°	44.3	
50	165	230	125	20	18	4 x 90°	56.3	155	203	120	16	19	4 x 90°	56.3	
65	185	290	145	22	18	8 x 45°	66.0	175	216	140	18	19	4 x 90°	71.5	
80	200	310	160	24	18	8 x 45°	81.0	185	241	150	18	19	8 x 45°	84.3	
100	235	350	190	24	22	8 x 45°	100.0	292	292	175	18	19	8 x 45°	109.1	

Nominal diameter (pipe)	ANSI B 16.5 Class 150 FTF 37 acc. to DIN EN 558-2						
	NPS	Ø DF	LF	Ø BF	AF	Ø D	A x α
½	89	184	60.5	11.2	15.7	4 x 90°	15.7
¾	99	184	69.9	12.7	15.7	4 x 90°	20.8
1	108	184	79.2	14.2	15.7	4 x 90°	26.7
1½	127	222	98.6	17.5	15.7	4 x 90°	40.9
2	152	254	120.7	19.1	19.1	4 x 90°	52.6
2½	178	276	139.7	22.3	19.1	4 x 90°	62.7
3	190	298	152.5	23.9	19.1	4 x 90°	78.0
4	229	352	190.5	23.9	19.1	8 x 45°	102.4

DTS 1000112693 EN Version: AF Status: RL (released | freigegeben | valide) printed: 09.03.2023

6.3. Body with threaded connection

Note:

Dimensions in mm, unless otherwise stated

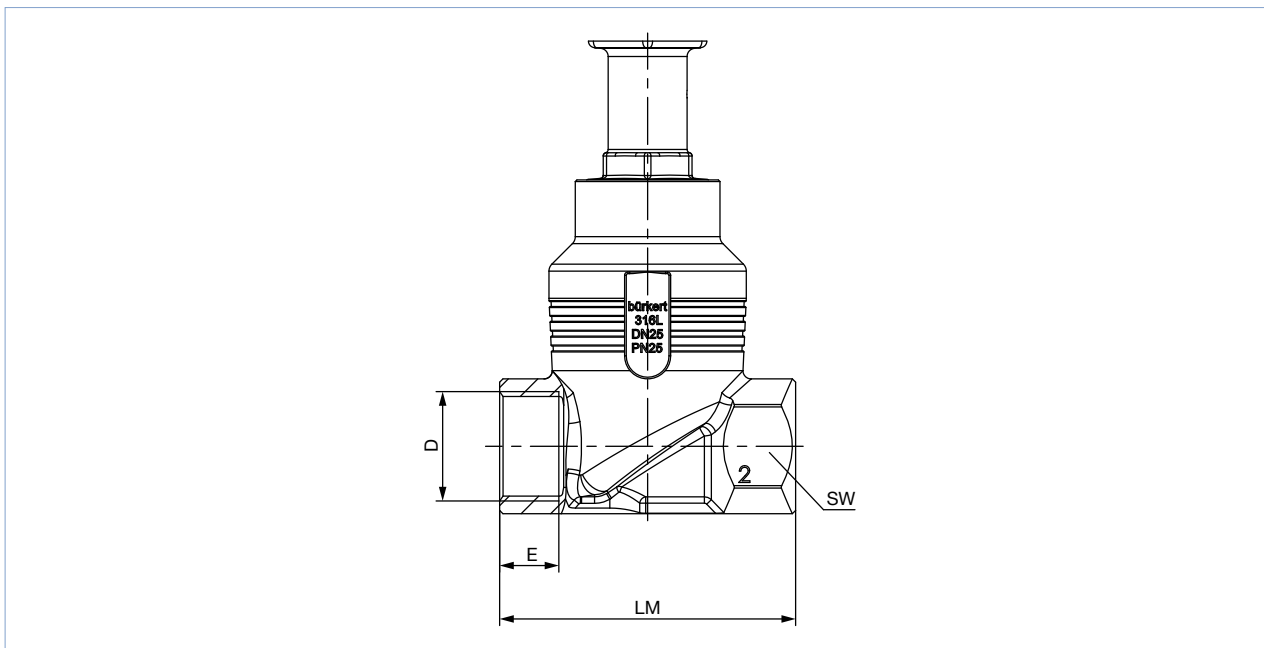

Nominal diameter (pipe)	G, Rc, NPT (EN ISO 228 - 1, ISO 7/1/DIN EN 10226 - 2, ASME B 1.20.1)				LM	SW
	D	E	[G]	[NPT]		
DN	NPS	[G]	[NPT]	[Rc]		
10	3/8	12	10.3	10.1	65	27
15	1/2	14	13.7	13.2	65	27
20	3/4	16	14	14.5	75	34
25	1	18	16.8	16.8	90	41
32	1 1/4	20	17.3	19.1	110	50
40	1 1/2	22	17.3	19.1	120	55
50	2	24	17.6	23.4	150	70
65	2 1/2	26	23.7	26.7	185	85
80	3	28	30.5	29.8	205	100
100	4	32	33	35.8	240	125

6.4. Body with welded connection

Note:

Dimensions in mm, unless otherwise stated

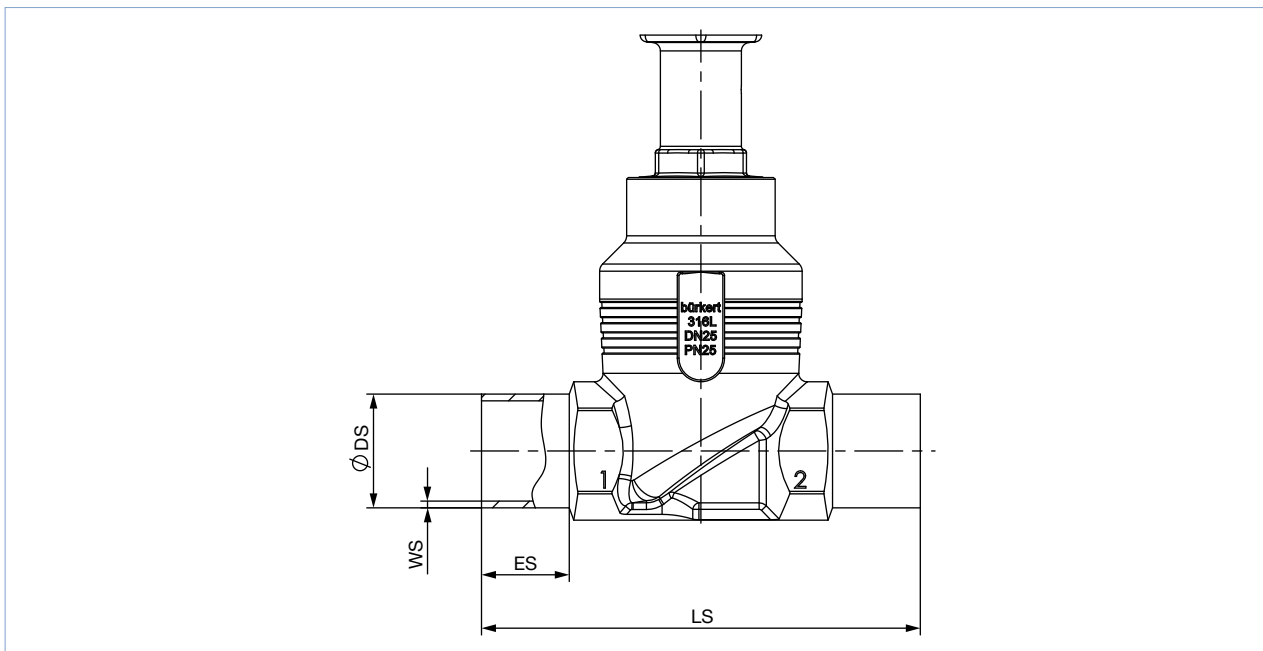

Nominal diameter (pipe) DN	ES	LS	EN ISO 1127 1/ISO 4200/DIN 11866 B		DIN 11850 2/DIN 11866 A/DIN EN 10357 A	
			Ø DS	WS	Ø DS	WS
10	20	90	17.2	1.6	13	1.5
15	20	90	21.3	1.6	19	1.5
20	20	100	26.9	1.6	23	1.5
25	26	130	33.7	2.0	29	1.5
32	26	140	42.4	2.0	35	1.5
40	26	150	48.3	2.0	41	1.5
50	26	175	60.3	2.0	53	1.5
65	26	210	76.1	2.3	70	2.0
80	26	230	88.9	2.3	85	2.0
100	26	260	114.3	2.6	104	2.0

Nominal diameter (pipe) NPS	ES	LS	ASME BPE/DIN 11866 C	
			Ø DS	WS
½	20	90	12.7	1.65
¾	20	90	19.05	1.65
1	20	100	25.4	1.65
1½	26	140	38.1	1.65
2	26	150	50.8	1.65
2½	26	175	63.5	1.65
3	26	210	76.2	1.65
4	26	260	101.6	2.11

DTS 1000112693 EN Version: AF Status: RL (released | freigegeben | valide) printed: 09.03.2023

6.5. Body with clamp connection

Note:

Dimensions in mm, unless otherwise stated

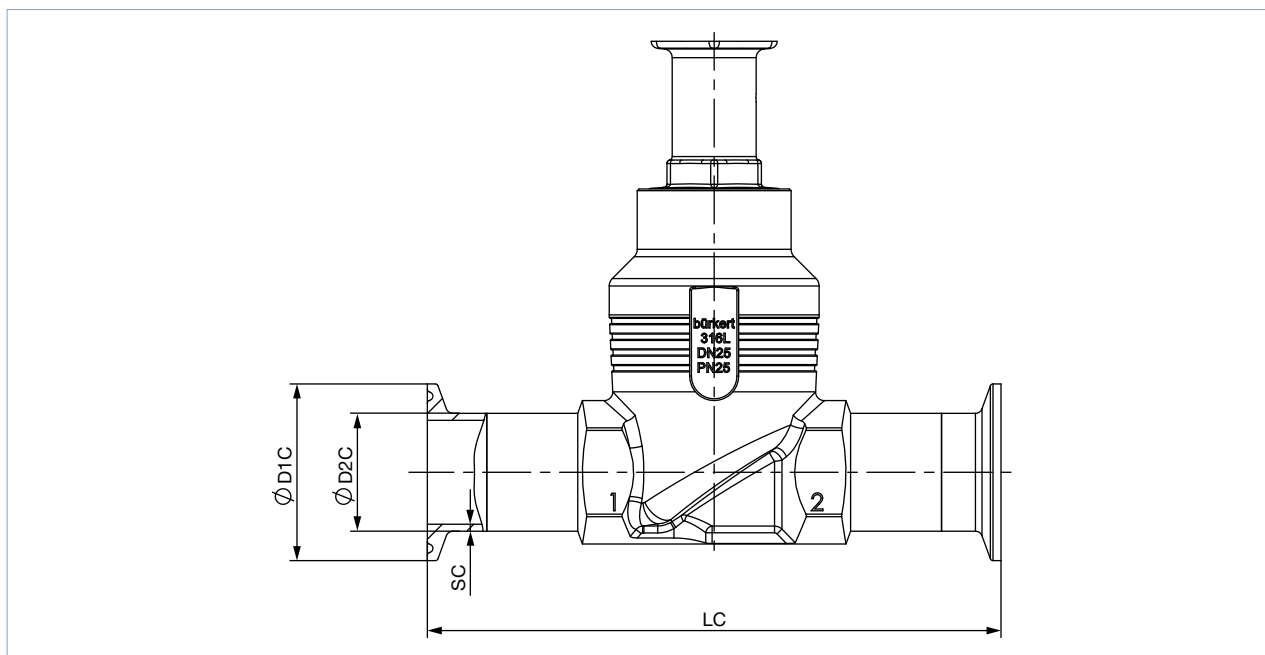

Nominal diameter (pipe)	Clamp: DIN 32676 A				Clamp: DIN 32676 B			
	Pipe: DIN 11850 2 DIN 11866 A DIN EN 10357 A				Pipe: EN ISO 1127 1 ISO 4200 DIN 11866 B			
DN	LC	Ø D2 C	Ø D1 C	SC	LC	Ø D2 C	Ø D1 C	SC
15	126	19	34	1.5	146	21.3	50.5	1.6
20	136	23	34	1.5	136	26.9	50.5	1.6
25	173	29	50.5	1.5	164	33.7	50.5	2.0
40	193	41	50.5	1.5	193	48.3	64.0	2.0
50	218	53	64	1.5	218	60.3	77.5	2.0

Nominal diameter (pipe)	Clamp: ASME BPE DIN 32676 C			
	Pipe: ASME BPE DIN 11866 C			
NPS	LC	Ø D2 C	Ø D1 C	SC
½	122	12.7	25.0	1.65
¾	126	19.05	25.0	1.65
1	126	25.4	50.5	1.65
1½	172	38.1	50.5	1.65
2	182	50.8	64.0	1.65
2½	231	63.5	77.5	1.65
3	265	76.2	91.0	1.65
4	315	101.6	119.0	2.11

DTS 1000112693 EN Version: AF Status: RL (released | freigegeben | valide) printed: 09.03.2023

7. Performance specifications

7.1. Fluidic data

Flow characteristics

- Flow characteristic acc. to DIN EN 60534-2-4
- K_{VR} value at 5 % of stroke for $DN > 10$ mm
 K_{VR} value at 10 % of stroke for $DN \leq 10$ mm
- Actuator size 70 offers a better control quality compared to actuator size 50 and is therefore preferred (K_{VR} value = smallest K_V value, at which the tilt tolerance according to DIN EN 60534-2-4 is still maintained).

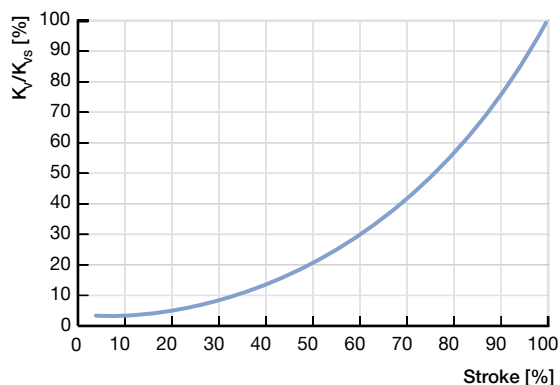

Equal percentage flow curve - detailed values please see below

Overview of fluidic data for flow under seat (for gases, steam and liquids)

Note:

- K_V value [m^3/h]: Measured with water acc. to DIN EN 60534-2-3
- See "7.2. Operating limits" on page 16.

Nominal diameter (pipe)		Seat size	Actuator size Ø	Operating pressure max. CF: A (Seat leakage class)			Characteristic curve (theoretical rangeability)	K_V value at stroke [m^3/h]						K_{VS} value		
				Seat seal				5%	10%	30%	50%	70%	90%			
DN	NPS		[mm]	Stainless steel [bar(g)]	PTFE [bar(g)]	PEEK [bar(g)]										
10	¾ ⁽¹⁾	3	50(D)	16(IV)	-	-	Linear (10:1)	-	0.003	0.015	0.037	0.065	0.090	0.10		
			70(M)	25(IV)												
		4	50(D)	16(IV)			Linear (25:1)	-	0.015	0.10	0.19	0.27	0.33	0.35		
			70(M)	25(IV)												
		4	50(D)	16(IV)			Linear (10:1)	-	0.050	0.16	0.27	0.36	0.44	0.50		
			70(M)	25(IV)												
		6	50(D)	16(IV)			Linear (25:1)	-	0.12	0.48	0.76	0.98	1.1	1.2		
			70(M)	25(IV)												
		6	50(D)	16(IV)			16(VI)	10(VI)	Equal percentage (50:1)	-	0.007	0.045	0.16	0.41	1.1	1.25
			70(M)	25(IV)			25(VI)	25(VI)								
		8	50(D)	16(IV)			16(VI)	10(VI)	-	0.070	0.12	0.26	0.61	1.5	2.0	
			70(M)	25(IV)			25(VI)	25(VI)								
10	50(D)	16(IV)	16(VI)	10(VI)	-	0.11	0.19	0.48	1.0	2.3	2.7					
	70(M)	25(IV)	25(VI)	25(VI)												

DTS 1000112693 EN Version: AF Status: RL (released | freigegeben | valide) printed: 09.03.2023

Nominal diameter (pipe)		Seat size	Actuator size Ø	Operating pressure max. CF: A (Seat leakage class)			Characteristic curve (theoretical rangeability)	K _v value at stroke [m³/h]						K _{vs} value
				Seat seal				5%	10%	30%	50%	70%	90%	
DN	NPS	[mm]	Stainless steel [bar(g)]	PTFE [bar(g)]	PEEK [bar(g)]	[m³/h]								
15	½ ^{1,3}	3	50(D)	16(IV)	-	-	Linear (10:1)	-	0.003	0.015	0.037	0.065	0.090	0.10
			70(M)	25(IV)										
		4	50(D)	16(IV)			Linear (25:1)	-	0.015	0.10	0.19	0.27	0.33	0.35
			70(M)	25(IV)										
		4	50(D)	16(IV)			Linear (10:1)	-	0.050	0.16	0.27	0.36	0.44	0.50
			70(M)	25(IV)										
		6	50(D)	16(IV)			Linear (25:1)	-	0.12	0.48	0.76	0.98	1.1	1.2
			70(M)	25(IV)										
	6	50(D)	16(IV)	16(VI)	10(VI)	Equal percentage (50:1)	-	0.007	0.045	0.16	0.41	1.1	1.25	
			70(M)	25(IV)	25(VI)									25(VI)
		8	50(D)	16(IV)	16(VI)									10(VI)
			70(M)	25(IV)	25(VI)									25(VI)
		10	50(D)	16(IV)	16(VI)									10(VI)
			70(M)	25(IV)	25(VI)									25(VI)
	15	50(D)	16(IV)	16(VI)	10(VI)									
		70(M)	25(IV)	25(VI)	25(VI)									
20	¾ ^{1,3}	10	50(D)	16(IV)	16(VI)	10(VI)	0.11	0.12	0.20	0.52	1.2	2.6	3.2	
			70(M)	25(IV)	25(VI)	10(VI)								
		15	50(D)	16(IV)	16(VI)	10(VI)	0.14	0.17	0.35	0.80	1.8	4.0	5.2	
			70(M)	25(IV)	25(VI)	25(VI)								
		20	70(M)	16(IV)	16(VI)	10(VI)	0.20	0.25	0.45	1.1	2.4	5.2	7.1	
			90(N)	25(IV)	25(VI)	25(VI)								
25	1	15	50(D)	16(IV)	16(VI)	10(VI)	0.14	0.17	0.35	0.80	1.8	4.1	5.3	
			70(M)	25(IV)	25(VI)	25(VI)								
		20	70(M)	16(IV)	16(VI)	10(VI)	0.20	0.25	0.47	1.1	2.5	5.4	7.2	
			90(N)	25(IV)	25(VI)	25(VI)								
		25	70(M)	12(III)	12(VI)	7(VI)	0.35	0.38	1.0	2.2	5.1	9.4	12.0	
			90(N)	25(IV)	25(VI)	20(VI)								
32	1¼ ^{1,3}	20	90(N)	25(IV)	25(VI)	25(VI)	0.21	0.24	0.45	0.85	1.8	3.8	5.5	
			130(P)		25(VI)	25(VI)								
		25	90(N)		20(VI)	20(VI)	0.38	0.45	0.93	1.8	3.7	6.7	8.9	
			130(P)		25(VI)	25(VI)								
		32	90(N)	16(IV)	16(VI)	10(VI)	0.45	0.58	1.1	2.5	4.9	10.1	13.4	
			130(P)	25(IV)	25(VI)	20(VI)	0.48	0.60	1.3	3.1	6.8	14.0	17.8	
40	1½ ^{1,3}	25	90(N)	25(IV)	25(VI)	10(VI)	0.38	0.48	0.95	1.9	3.7	7.2	9.4	
			130(P)		25(VI)	25(VI)								
		32	90(N)	16(IV)	16(VI)	10(VI)	0.45	0.55	1.1	2.5	5.0	10.8	14.4	
			130(P)	25(IV)	25(VI)	20(VI)	0.48	0.60	1.3	3.2	6.9	15.0	20.0	
		40	90(N)	12(III)	12(VI)	7(VI)	0.55	0.67	1.5	3.2	6.5	13.6	17.5	
			130(P)	25(IV)	25(VI)	20(VI)	0.60	0.70	1.7	4.0	9.2	18.2	23.8	
50	2 ^{1,3}	32	90(N)	16(IV)	16(VI)	10(VI)	0.45	0.56	1.1	2.5	5.0	11.4	15.3	
			130(P)	25(20 ^{2,3})(IV)	25(20 ^{2,3})(VI)	20(VI)	0.48	0.60	1.3	3.2	6.9	16.0	21.0	
		40	90(N)	12(III)	12(VI)	7(VI)	0.57	0.68	1.5	3.2	6.4	13.8	18.0	
			130(P)	25(20 ^{2,3})(IV)	25(20 ^{2,3})(VI)	20(VI)	0.60	0.70	1.7	4.0	9.2	18.9	24.5	
		50	90(N)	7(III)	7(VI)	-	0.85	1.1	2.6	5.4	11.4	21.5	28.0	
			130(P)	25(20 ^{2,3})(IV)	25(20 ^{2,3})(VI)	20(VI)	0.90	1.1	2.9	6.8	15.5	29.5	37.0	
65	2½ ^{1,3}	40	130(P)	25(15 ^{2,3})(IV)	25(15 ^{2,3})(VI)	20(15 ^{2,3})(VI)	0.65	0.75	1.8	4.3	10.4	22.0	29.0	
		50	130(P)				1.0	1.2	3.1	6.7	16.0	35.0	45.0	
		65	130(P)	16(15 ^{2,3})(IV)	16(15 ^{2,3})(VI)	10(VI)	1.6	2.0	5.0	13.5	33.0	56	65	
		225 (L)	25(15 ^{2,3})(IV)	25 (15 ^{2,3})(VI)	10 (VI)	1.1	1.4	3.2	8.0	18.5	46.5	62		

DTS 1000112693 EN Version: AF Status: RL (released | freigegeben | valide) printed: 09.03.2023

Nominal diameter (pipe)		Seat size	Actuator size Ø	Operating pressure max. CF: A (Seat leakage class)			Characteristic curve (theoretical rangeability)	K _v value at stroke [m ³ /h]						K _{vs} value
				Stainless steel	PTFE	PEEK		5%	10%	30%	50%	70%	90%	
DN	NPS		[mm]	[bar(g)]	[bar(g)]	[bar(g)]		[m ³ /h]						
80	3 ¹⁾	50	130(P)	25(12.5 ²⁾ (IV)	25(12.5 ²⁾ (VI)	10(VI)	Equal percentage (50:1)	1.0	1.2	3.4	8.3	19.0	35.0	45.0
			65	130(P)	16(12.5 ²⁾ (IV)	16(12.5 ²⁾ (VI)		10(VI)	1.6	2.0	5.0	13.0	35.0	61
			225 (L)	25(12.5 ²⁾ (IV)	25(12.5 ²⁾ (VI)	10(VI)		1.4	1.7	3.8	8.2	19.5	50	70
		80	130(P)	10(III)	10(VI)	10(VI)		2.5	3.4	10.7	27.0	58	87	100
			225 (L)	12.5(IV)	12.5(VI)	7(VI)		2.1	2.6	7.0	16.0	40.0	83	100
		100	4	65	130(P)	16(10 ²)(IV)		16(10 ²)(VI)	10(VI)	1.4	1.8	5.0	15.0	37.0
225 (L)	25(10 ²)(IV)				25(10 ²)(VI)	10(VI)		1.4	1.7	3.8	8.3	20.0	51	75
80	130(P)			10(III)	10(VI)	10(VI)		2.2	3.1	10.3	30.0	66	97	110
	225 (L)			12.5(10 ²)(IV)	12.5(10 ²)(VI)	7(VI)		2.1	2.6	7.0	17.0	44.0	89	115
100	130(P)			6(III)	6(VI)	-		3.8	5.2	15.0	46.5	90	128	140
	225 (L)			10(IV)	10(VI)	-		3.2	3.9	9.0	20.5	51	118	140

- 1.) Deviation for line connections according to ASME BPE: the next larger nominal connection size is used, e.g. NPS 1 instead of NPS ¾
- 2.) According to the pressure equipment directive 97/23/EC for compressible fluids of group 1 (dangerous gases and vapours according to article 3 point 1.3 letter a, first indent)

Pilot pressure diagram with flow direction below seat (Control function B)

Note:

d = Seat size

Actuator size Ø: 50 mm

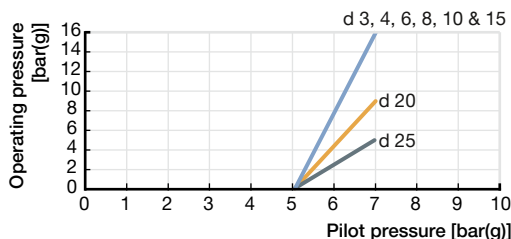

Actuator size Ø: 70 mm

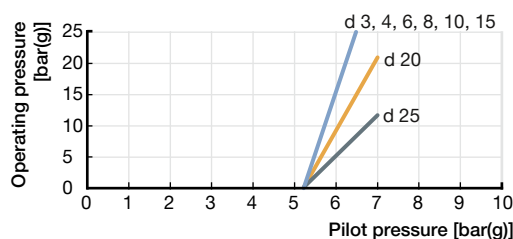

Actuator size Ø: 90 mm

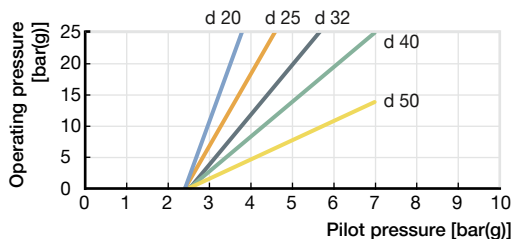

Actuator size Ø: 130 mm

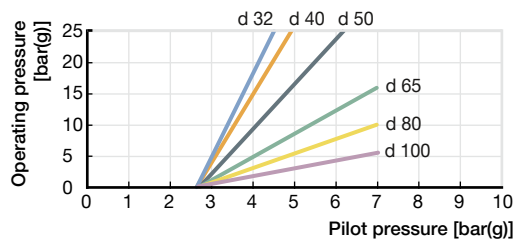

DTS 1000112693 EN Version: AF Status: RL (released | freigegeben | valide) printed: 09.03.2023

7.2. Operating limits

Operating limits for medium temperature and operating pressure

The operating range of Bürkert process valves is in addition to the maximum operating pressures limited by the nominal pressure according to the relevant standard.

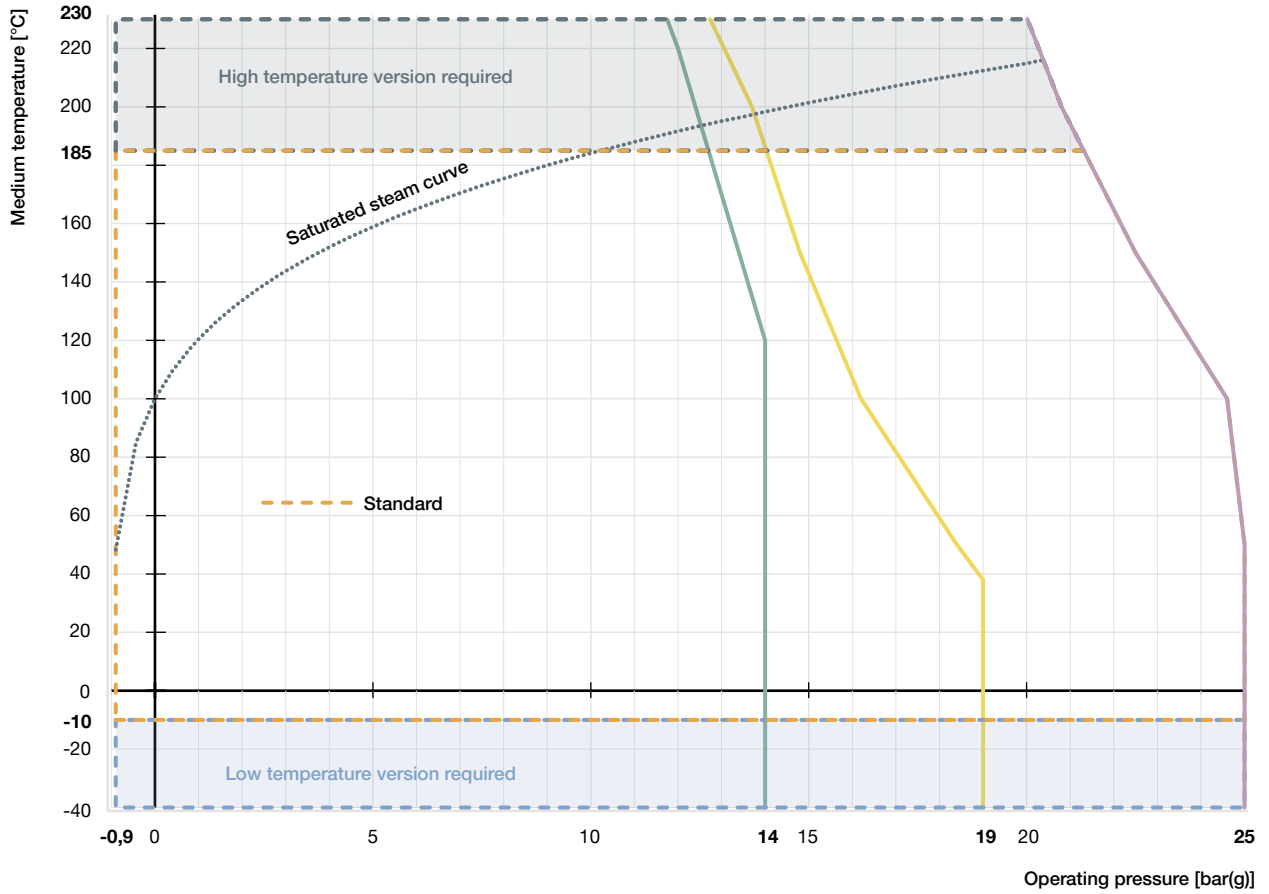

- Operating limits for PN25 acc. to DIN EN 12516-1
- Operating limits for flange 10K acc. to JIS B 2220
- Operating limits for Class 150 acc. to ASME B16.34
- ⋯ Saturated steam curve for water

Operating limits for ambient and medium temperature

ELEMENT Actuator

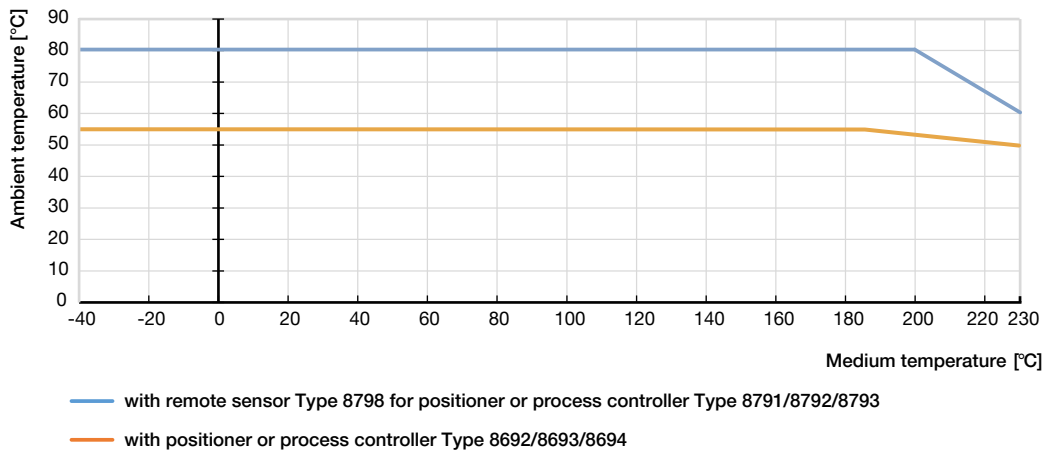

Operating limits for seat seal

Tight sealing required	Leakage class (DIN EN 60534 - 4)	Medium temperature	Seat seal
No An additional shut-off valve is recommended	III/IV (metal seals) Metal-sealed valves have larger leakages (0.1 % or 0.01 % of the nominal flow rate are permissible). Metallic seals are impervious even under demanding process conditions.	-40...230 °C	Stainless steel
	For particularly demanding process conditions such as cavitation, erosion by wet steam or abrasive media, hardened cones and seats can be used to significantly increase the service life.		Hardened stainless steel
Yes An additional shut-off valve is often unnecessary.	VI (soft seals) By using plastics as sealing material, the control valves can close tightly.	-40...130 °C (recommended for ≤ 130 °C)	PTFE
	Their use is not recommended in cases of increased erosion due to demanding process conditions.	-10...230 °C (recommended for > 130 °C)	PEEK

DTS 1000112693 EN Version: AF Status: RL (released | freigegeben | validé) printed: 09.03.2023

Operating limits for optional versions**High temperature version**

By adapting the spindle sealing this version is suitable for applications with steam, neutral gases and other heat transfer mediums up to 230 °C.

Hot water version

For applications with hot water up to 200 °C; a special configuration of the spindle seal increases the lifetime significantly. It is recommended for water temperatures starting at 85 °C.

Drinking water version

Materials in contact with the medium are tested for suitability with drinking water up to 85 °C.

Vacuum version

Without leakage bore, this design is suitable for pressures down to -0.9 bar(g).

Low temperature version

Suitable for minimum medium temperatures down to -40 °C

Version for oxygen



Non-metallic materials in contact with the medium are tested for suitability with oxygen. Suitable for operating pressures up to 25 bar(g) and medium temperatures up to 60 °C.

8. Product accessories

Process controller TopControl	
Type 8693 ▶ Actuator size Ø 70/90/130 mm	Description
	<p>The intelligent process controller Type 8693 is designed for integrated mounting on pneumatic actuators from the process control valve series Type 23xx/2103 and especially for the requirements of hygienic process conditions. Using the TUNE-Functions, the process and positioner can be initialized automatically. Easy operation and selection of additional software functions as well as parameterization are carried out via the large graphic display and the membrane keypad. Device configuration and parameterization can also be conveniently carried out by the Bürkert Communicator software tool via a PC interface.</p> <p>Features</p> <ul style="list-style-type: none"> • Contactless position sensor • Universal control system for single and double acting actuators • Highly dynamic actuating system without internal control air consumption in the balanced state • Integrated diagnostic functions for valve monitoring • Automatic initialization of the positioner and process controller using the TUNE-Function • Safeguarding in the event of failure of the electrical or pneumatic auxiliary power • PROFIBUS DP-V1, EtherNet/IP, PROFINET, Modbus TCP, Bürkert system bus (bùS) • Compact and robust hygienic stainless steel design <p>Customer benefits</p> <ul style="list-style-type: none"> • Quick and easy commissioning • Intuitive and simple operation via graphic display with backlight and membrane keyboard • High system availability due to increased drive service life by means of spring chamber ventilation • Guaranteed reliability and predictable maintenance through valve monitoring and diagnostics • Easy maintenance and process monitoring

Positioner TopControl	
Type 8692 ▶ Actuator size Ø 70/90/130 mm	Description
	<p>The intelligent electropneumatic positioner Type 8692 is designed for integrated attachment to pneumatic actuators of the process control valve series Type 23xx/2103 and especially for the requirements of hygienic process conditions. The positioner can be initialized automatically using the TUNE-Function. Easy operation and the selection of the extensive additional software functions as well as parameterization are carried out via the large graphic display and the membrane keypad. The device configuration and parameterization can also be conveniently carried out using the Bürkert Communicator software tool via a PC interface.</p> <p>Features</p> <ul style="list-style-type: none"> • Contactless position sensor • Universal positioning system for single and double-acting actuators • Highly dynamic positioning system without internal control air consumption • Integrated diagnostic functions for valve monitoring • Automatic initialization of the positioner by means of the TUNE-Function • Safeguard in the event of failure of the electrical or pneumatic auxiliary power • PROFIBUS DP-V1, EtherNet/IP, PROFINET, Modbus TCP, Bürkert system bus (büS) • Compact and robust hygienic stainless steel design <p>Customer benefits</p> <ul style="list-style-type: none"> • Quick and easy commissioning • Intuitive and simple operation via graphic display with backlight and touch keypad • Guaranteed reliability and predictable maintenance through valve monitoring and diagnostics • A high degree of system availability due to increased drive service life by means of spring chamber ventilation
Positioner TopControl BASIC	
Type 8694 ▶ Actuator size Ø 70/90/130 mm	Description
	<p>The compact positioner Type 8694/8696 is designed for integrated attachment to pneumatic actuators of the Type 23xx/2103 Process Control Valve series and especially for the requirements of hygienic process conditions. Operation and parameterization are performed via push buttons and DIP switches. The device configuration and parameterization can also be conveniently carried out using the Bürkert Communicator software tool via a PC interface.</p> <p>Features</p> <ul style="list-style-type: none"> • Contactless position sensor • Universal positioning system for single and double-acting actuators • Ultra dynamic positioning system without internal control air consumption • AS-Interface, IO-Link, Bürkert system bus (büS) (only 8694) • Compact and robust hygienic stainless steel design
Type 8696 ▶ Actuator size Ø 50 mm	Customer benefits
	<ul style="list-style-type: none"> • Simple and safe commissioning through Teach-In function • Minimum space requirement in the plant pipework for more flexibility in plant design • A high degree of system availability due to increased drive service life by means of spring chamber ventilation

Process controller SideControl Remote	
Type 8793 ▶ with Remote Sensor 8798 ▶ Actuator size Ø 70/90/130 mm	Description
	<p>The intelligent digital positioner/process controller Type 8793 is designed for mounting on lift or swivel drives with standardization in accordance with IEC 534-6 or VDI/VDE 3845 and is designed for demanding control tasks. The version with remote position sensor Type 8798 is used to control Bürkert process control valves. It is operated via a backlit graphic display. The initialization of process and positioner can be done automatically by means of TUNE-Function. Here the type of controlled system is automatically recognized and the appropriate controller structure with the corresponding optimum parameter set is determined.</p> <p>Features</p> <ul style="list-style-type: none"> • Universal control system for single and double acting actuators • Integrated diagnostic functions for valve monitoring • Automatic initialization of the position and process controller by means of TUNE-Function • Ultra dynamic actuating system without internal control air consumption. • Illuminated graphic display with touch screen • PROFIBUS DP-V1, EtherNet/IP, PROFINET, Modbus TCP, Bürkert system bus (büs) • Compact and robust design • Adaptation acc. to IEC 534-6 or VDI / VDE 3845 for lift and swivel drives or as remote version on Bürkert process valves <p>Customer benefits</p> <ul style="list-style-type: none"> • Quick and easy commissioning • Intuitive and simple operation via graphic display with backlight and touch keypad. • Guaranteed reliability and scheduled maintenance thanks to valve monitoring and diagnostics. • Easy maintenance and process monitoring • Long service life

Positioner SideControl Remote	
Positioner Type 8792 ▶ with Remote Sensor Type 8798 ▶ Actuator size Ø 70/90/130 mm	Description The intelligent digital position/process controller Type 8792 is designed for attachment to lift and swivel drives with standardization according to IEC 534-6 or VDI/VDE 3845 for demanding control tasks. The Type 8798 version with remote position sensor is used to control Bürkert process control valves. It is operated via a backlit graphic display. The initialization of process and positioner can be done automatically by means of TUNE-Function. Features <ul style="list-style-type: none"> • Illuminated graphic display with touch screen • Universal control system for single and double acting actuators • Ultra dynamic actuating system without internal control air consumption. • Integrated diagnostic functions for valve monitoring • PROFIBUS DP-V1, EtherNet/IP, PROFINET, Modbus TCP, Bürkert system bus (büS) • Compact and robust design • Adaptation acc. to IEC 534-6 or VDI / VDE 3845 for lift and swivel drives or as remote version on Bürkert process valves Customer benefits <ul style="list-style-type: none"> • Quick and easy commissioning • Intuitive and simple operation via backlit graphic display and touch keypad. • Guaranteed reliability and scheduled maintenance thanks to valve monitoring and diagnostics. • Long service life
	
Positioner SideControl BASIC Remote	
Positioner Type 8791 ▶ with Remote Sensor Type 8798 ▶ Actuator size Ø 70/90/130 mm	Description The positioner Type 8791 is designed for mounting on lift or swivel drives with standardization in accordance with IEC 534-6 or VDI/VDE 3845 designed for simple control tasks. The variant with the remote sensor Type 8798 is used to control Bürkert process control valves. All operating elements are located inside the housing. Features <ul style="list-style-type: none"> • Simple design • Universal control system for single and double acting actuators • Highly dynamic actuating system without internal control air consumption in the balanced state • Adaptation according to IEC 534-6 or VDI/VDE 3845 for lift and swivel drives or as remote version on Bürkert process valves • AS-Interface, IO-Link, Bürkert system bus (büS) (only for Positioner Type 8791 BASIC Remote) Customer benefits <ul style="list-style-type: none"> • Simple commissioning • Simple device for simple control tasks • Low energy consumption
	
Positioner IP20 Type 8791 ▶ with Remote Sensor Type 8798 ▶ Actuator size Ø 70/90/130 mm	
	

9. Networking and combination with other Bürkert products

The **Type 2301 Globe Control Valve** can be combined with our extensive range of positioners and process controllers to form the **Continuous ELEMENT valve system, Type 8802-GD**.

The range of the control unit consists of;

- A digital electropneumatic positioner/process controller **Type 8692/8693** (for valve actuator sizes Ø 70/90/130 mm)
- A digital electropneumatic positioner, basic **Type 8694** (for valve actuator size Ø 70/90/130 mm)
- A digital electropneumatic positioner, basic **Type 8696** (for valve actuator size Ø 50 mm)
- An electropneumatic positioner, SideControl **Type 8792** or an electropneumatic process controller, **Type 8793** (for valve actuator size Ø 70/90/130 mm) and a remote sensor, **Type 8798**
- An electropneumatic positioner, SideControl Basic **Type 8791** (for valve actuator size Ø 70/90/130 mm) and a remote sensor, **Type 8798**

Note:

- For the configuration of further valve systems please use the **product enquiry form** at the end of this data sheet.
- You order two components and receive a completely assembled and tested valve.

Example with threaded connection

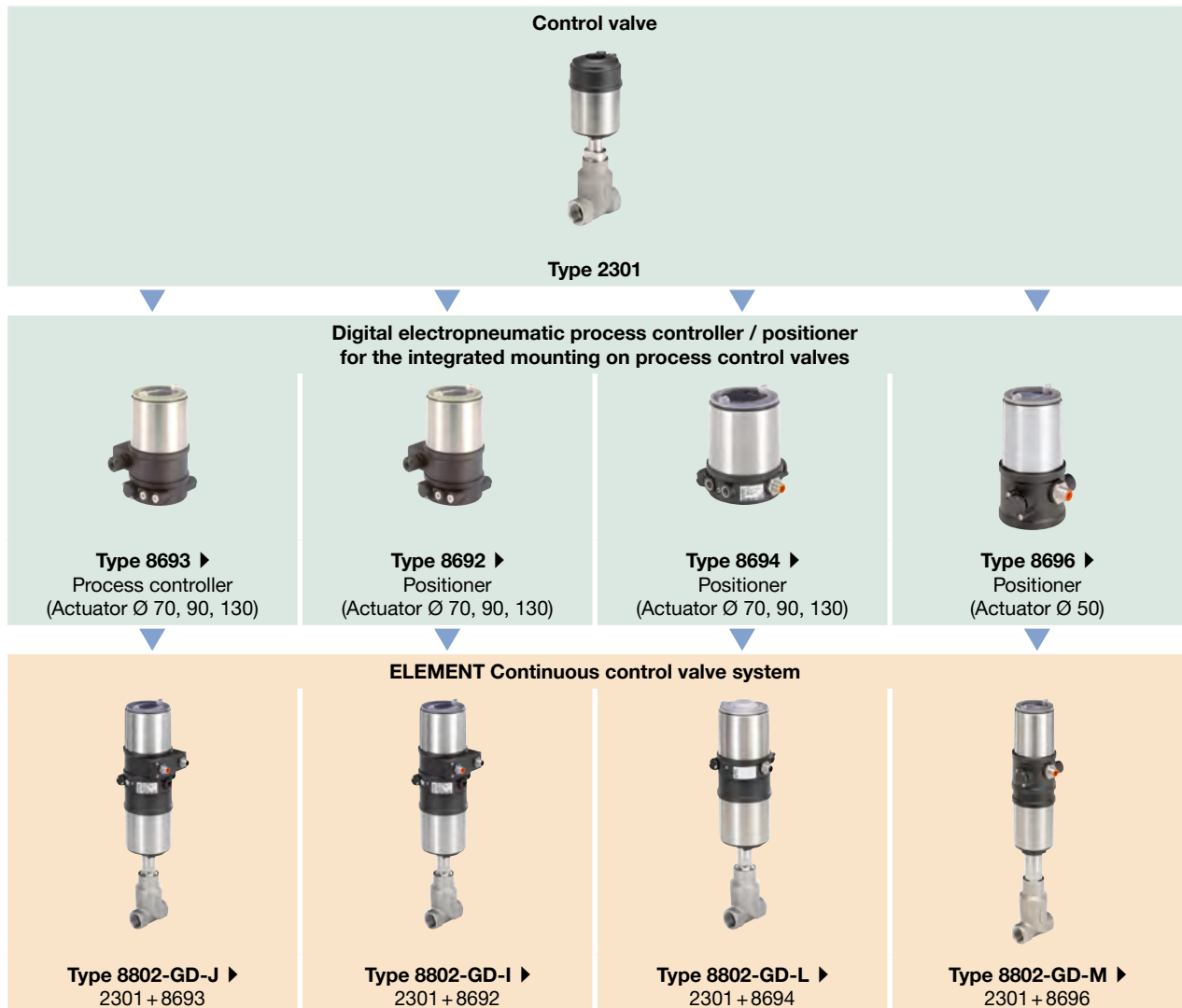

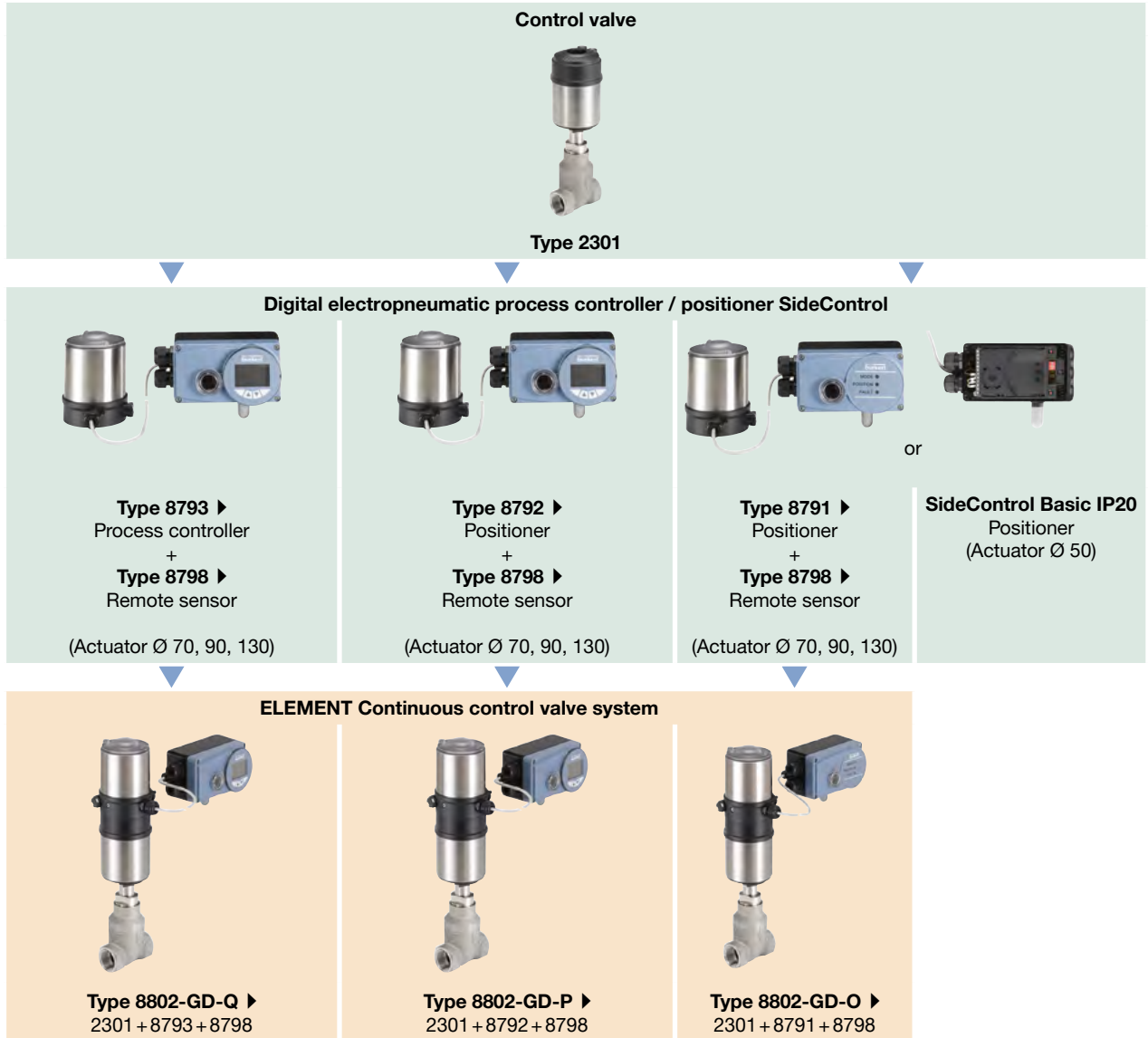

10. Ordering information

10.1. Bürkert eShop – Easy ordering and quick delivery



Bürkert eShop – Easy ordering and fast delivery

You want to find your desired Bürkert product or spare part quickly and order directly? Our online shop is available for you 24/7. Sign up and enjoy all the benefits.

[Order online now](#)

10.2. Bürkert product filter



Bürkert product filter – Get quickly to the right product

You want to select products comfortably based on your technical requirements? Use the Bürkert product filter and find suitable articles for your application quickly and easily.

[Try out our product filter](#)

10.3. Ordering chart flange connection

Valve with flow direction below seat

Nominal diameter (pipe)		Seat size	Actuator size Ø	K _{vs} value	Article no.	
DN	NPS				Seat seal	
DIN EN 1092-1			[mm]	[m ³ /h]	PTFE	Stainless steel
10	3/8	3	70(M)	0.1	-	On request
		4	70(M)	0.5	-	215207
		6	70(M)	1.2	-	215209
		8	70(M)	2.0	213985	215212
		10	70(M)	2.7	213989	215215
15	1/2	3	70(M)	0.1	-	233165
		4	70(M)	0.5	-	210529
		6	70(M)	1.2	-	215211
		8	70(M)	2.1	213987	215214
		10	70(M)	3.1	213991	215217
		15	70(M)	4.3	204932	205010
20	3/4	10	70(M)	3.2	210530	215218
		15	70(M)	5.2	213993	214030
		20	70(M)	7.1	204935	205012
25	1	15	70(M)	5.3	213994	214031
		20	70(M)	7.2	213995	214032
		25	70(M)	12.0	204937	205014
			90(N)	12.0	242054	229421
32	1 1/4	25	90(N)	8.9	213997	210446
			130(P)	13.0	222634	222655
		32	90(N)	13.4	204939	205016
			130(P)	17.8	223597	223598
40	1 1/2	32	90(N)	14.4	213999	214035
			130(P)	20.2	222636	222657
		40	90(N)	17.5	204941	205018
			130(P)	23.8	219791	222659
50	2	40	90(N)	18.0	214001	214037
			130(P)	24.6	222638	222660
		50	90(N)	28.0	204942	205019
			130(P)	37.0	214003	214039
65	2 1/2	50	130(P)	45.0	214005	214040
		65	130(P)	65.0	217772	219618
80	3	65	130(P)	73.0	239545	239581
		80	130(P)	100.0	239540	239576
100	4	80	130(P)	110.0	239561	239597
		100	130(P)	140.0	239556	331125

Nominal diameter (pipe)		Seat size	Actuator size Ø	K _{vs} value	Article no.	
DN	NPS				Seat seal	
			[mm]	[m ³ /h]	PTFE	Stainless steel
JIS 10K						
15	½	3	70(M)	0.1	-	On request
		4	70(M)	0.5	-	215226
		6	70(M)	1.2	-	215227
		8	70(M)	2.1	215203	215228
		10	70(M)	3.1	213913	213911
		15	70(M)	4.3	204953	205030
20	¾	10	70(M)	3.2	215204	215229
		15	70(M)	5.2	213936	213933
		20	70(M)	7.1	204955	205032
25	1	15	70(M)	5.3	214020	214059
		20	70(M)	7.2	213930	213914
		25	70(M)	12.0	204957	205034
			90(N)	12.0	242165	242199
32	1¼	25	90(N)	8.9	213939	213937
			130(P)	13.0	222643	222665
		32	90(N)	13.4	213177	213178
			130(P)	17.8	222645	222667
40	1½	32	90(N)	14.4	213932	213931
			130(P)	20.2	222647	222668
		40	90(N)	17.5	204959	205037
			130(P)	23.8	222649	222670
50	2	40	90(N)	18.0	213941	213940
			130(P)	24.6	222650	222671
		50	90(N)	28.0	204960	205038
			130(P)	37.0	214023	214062
65	2½	50	130(P)	45.0	214024	214063
		65	130(P)	65.0	219617	219620
80	3	65	130(P)	73.0	239547	239584
		80	130(P)	100.0	239542	239578
100	4	80	130(P)	110.0	239563	239599
		100	130(P)	140.0	239558	239594

Nominal diameter (pipe)		Seat size	Actuator size Ø	K _{vs} value	Article no.	
DN	NPS				[mm]	[m ³ /h]
ANSI B 16.5						
15	½	3	70(M)	0.1	-	On request
		4	70(M)	0.5	-	215219
		6	70(M)	1.2	-	215220
		8	70(M)	2.1	215198	215221
		10	70(M)	3.1	215199	215222
		15	70(M)	4.3	204944	205021
20	¾	10	70(M)	3.2	215200	215223
		15	70(M)	5.2	214009	214046
		20	70(M)	7.1	204946	205023
25	1	15	70(M)	5.3	214010	214047
		20	70(M)	7.2	214011	214048
		25	70(M)	12.0	204948	205025
			90(N)	12.0	464851	464367
40	1½	32	90(N)	14.4	215201	215224
			130(P)	20.2	463905	463913
		40	90(N)	17.5	204950	205027
			130(P)	23.8	463907	463915
50	2	40	90(N)	18.0	214013	214050
			130(P)	24.6	463908	463916
		50	90(N)	28.0	204951	205028
			130(P)	37.0	214015	214052
65	2½	50	130(P)	45.0	239537	239573
		65	130(P)	65.0	239535	239572
80	3	65	130(P)	73.0	239546	239582
		80	130(P)	100.0	239541	239577
100	4	80	130(P)	110.0	239562	239598
		100	130(P)	140.0	239557	239593

Further versions on request

**Approval**

FDA, ATEX, (EG Gas Appliances Directive 2009/142/EG)

**Control function/Circuit function**

B (normally open: NO)

**Process connection**

Further housing connections

10.4. Ordering chart threaded connection

Valve with flow direction below seat

Nominal diameter (pipe)		Seat size	Actuator size Ø	K _{vs} value	Article no.	
[mm]	[inch]				Seat seal	
G thread, EN ISO 228 - 1			[mm]	[m ³ /h]	PTFE	Stainless steel
10	3/8	3	70(M)	0.1	-	284168
		4	70(M)	0.5	-	215238
		6	70(M)	1.2	-	215240
		8	70(M)	2.0	215233	215242
		10	70(M)	2.7	215235	215245
15	1/2	3	70(M)	0.1	-	227784
		4	70(M)	0.5	-	208843
		6	70(M)	1.2	-	215241
		8	70(M)	2.1	212964	215243
		10	70(M)	3.1	215236	215246
		15	70(M)	4.3	206432	213955
20	3/4	10	70(M)	3.2	215237	215247
		15	70(M)	5.2	214067	215248
		20	70(M)	7.1	206584	211239
25	1	15	70(M)	5.3	206588	210460
		20	70(M)	7.2	206586	210721
		25	70(M)	12.0	189145	210485
			90(N)	12.0	242203	242207
32	1 1/4	25	90(N)	8.9	214070	210407
			130(P)	13.0	222677	222687
		32	90(N)	13.4	210097	210458
			130(P)	17.8	223599	223600
		40	90(N)	14.4	214072	214084
40	1 1/2		130(P)	20.2	222679	222689
		40	90(N)	17.5	210098	207800
			130(P)	23.8	222681	222691
		50	90(N)	18.0	214074	214086
50	2		130(P)	24.6	222682	222692
		50	90(N)	28.0	210099	203693
			130(P)	37.0	214076	214088
65	2 1/2	50	130(P)	45.0	214077	214089
		65	130(P)	65.0	219621	219622

Nominal diameter (pipe)		Seat size	Actuator size Ø	K _{vs} value	Article no.	
[mm]	[inch]				Seat seal	
			[mm]	[m ³ /h]	PTFE	Stainless steel
NPT thread, ISO 7/1/DIN EN 10226-2						
10	3/8	3	70(M)	0.1	-	On request
		4	70(M)	0.5	-	220447
		6	70(M)	1.2	-	220450
		8	70(M)	2.0	220418	220453
		10	70(M)	2.7	220421	220457
15	1/2	3	70(M)	0.1	-	466159
		4	70(M)	0.5	-	220884
		6	70(M)	1.2	-	220452
		8	70(M)	2.1	220881	220455
		10	70(M)	3.1	220423	220459
		15	70(M)	4.3	220882	220886
20	3/4	10	70(M)	3.2	220425	220461
		15	70(M)	5.2	220427	220463
		20	70(M)	7.1	220430	220466
25	1	15	70(M)	5.3	220428	220464
		20	70(M)	7.2	220431	220467
		25	70(M)	12.0	220434	220470
		90(N)	12.0	464864	464867	
32	1 1/4	25	90(N)	8.9	220435	220471
			130(P)	13.0	463921	463931
		32	90(N)	13.4	220437	220473
			130(P)	17.8	463956	463957
40	1 1/2	32	90(N)	14.4	220438	463803
			130(P)	20.2	463923	463933
		40	90(N)	17.5	220440	220476
			130(P)	23.8	463925	463935
50	2	40	90(N)	18.0	220441	220477
			130(P)	24.6	463926	463936
		50	90(N)	28.0	220443	220479
65	2 1/2	130(P)	37.0	220444	220480	
		50	130(P)	45.0	239536	239620
		65	130(P)	65.0	239534	239571

Nominal diameter (pipe)		Seat size	Actuator size Ø	K _{vs} value	Article no. RC (ASME B 1.20.1)	
[mm]	[inch]				Seat seal	
[mm]	[inch]		[mm]	[m ³ /h]	PTFE	Stainless steel
Rc thread, ASME B 1.20.1						
10	⅜	3	70(M)	0.1	–	On request
		4	70(M)	0.5	–	220513
		6	70(M)	1.2	–	220516
		8	70(M)	2.0	220484	220519
		10	70(M)	2.7	220487	220523
15	½	3	70(M)	0.1	–	233369
		4	70(M)	0.5	–	220891
		6	70(M)	1.2	–	220518
		8	70(M)	2.1	220888	220521
		10	70(M)	3.1	220489	220525
		15	70(M)	4.3	220889	220894
20	¾	10	70(M)	3.2	220491	220527
		15	70(M)	5.2	220493	220529
		20	70(M)	7.1	220496	220532
25	1	15	70(M)	5.3	220494	220530
		20	70(M)	7.2	220497	220533
		25	70(M)	12.0	220500	220536
			90(N)	12.0	242377	242380
32	1¼	25	90(N)	8.9	220501	220537
			130(P)	13.0	222740	222777
		32	90(N)	13.4	220503	220539
			130(P)	17.8	223605	223606
40	1½	32	90(N)	14.4	220504	220540
			130(P)	20.2	222742	222763
		40	90(N)	17.5	220506	220542
			130(P)	23.8	222765	222767
50	2	40	90(N)	18.0	220507	220543
			130(P)	24.6	222768	222766
		50	90(N)	28.0	220509	220545
			130(P)	37.0	220510	220546
65	2½	50	130(P)	45.0	220511	220547
		65	130(P)	65.0	220512	220548

Further versions on request

**Approval**

FDA, ATEX, (EG Gas Appliances Directive 2009/142/EG)

**Control function/Circuit function**

















































B (normally open: NO)

**Process connection**































Further housing connections

10.5. Ordering chart welded connection

Valve with flow direction below seat

Nominal diameter (pipe)		Seat size	Actuator size Ø	K _{vs} value	Connection MW x TW	Article no.	
[mm]	[inch]					Seat seal	
			[mm]	[m ³ /h]		PTFE	Stainless steel
EN ISO 1127 1/ISO 4200/DIN 11866 B							
10	⅜	3	70(M)	0.1	17.2 x 1.6	–	On request
		4	70(M)	0.5	17.2 x 1.6	–	209904 
		6	70(M)	1.2	17.2 x 1.6	–	342944 
		8	70(M)	2.0	17.2 x 1.6	232891 	315915 
		10	70(M)	2.7	17.2 x 1.6	On request	337061 
15	½	3	70(M)	0.1	21.3 x 1.6	–	259240 
		4	70(M)	0.5	21.3 x 1.6	–	215254 
		6	70(M)	1.2	21.3 x 1.6	–	215255 
		8	70(M)	2.1	21.3 x 1.6	212392 	216407 
		10	70(M)	3.1	21.3 x 1.6	212393 	215873 
		15	70(M)	4.3	21.3 x 1.6	209571 	216409 
20	¾	15	70(M)	5.2	26.9 x 1.6	214094 	214132 
		20	70(M)	7.1	26.9 x 1.6	214096 	210696 
25	1	20	70(M)	7.2	33.7 x 2.0	214097 	214135 
		25	70(M)	12.0	33.7 x 2.0	209572 	214138 
32	1¼	25	90(N)	8.9	42.4 x 2.0	214101 	214139 
		32	90(N)	13.4	42.4 x 2.0	214103 	214141 
40	1½	32	90(N)	14.4	48.3 x 2.0	214104 	214142 
			130(P)	20.2	48.3 x 2.0	222700 	222721 
		40	90(N)	17.5	48.3 x 2.0	209440 	214144 
			130(P)	23.8	48.3 x 2.0	222702 	222723 
50	2	40	90(N)	18.0	60.3 x 2.0	210756 	213561 
			130(P)	24.6	60.3 x 2.0	222703 	222724 
		50	90(N)	28.0	60.3 x 2.0	214107 	214146 
			130(P)	37.0	60.3 x 2.0	214108 	214147 
65	2½	65	130(P)	65.0	76.1 x 2.3	219623 	219626 
80	3	80	130(P)	100.0	88.9 x 2.3	239543 	239579 
100	4	100	130(P)	140.0	114.3 x 2.6	239559 	239595 

Nominal diameter (pipe)		Seat size	Actuator size Ø	K _{vs} value	Connection MW x TW	Article no.	
[mm]	[inch]					Seat seal	
			[mm]	[m ³ /h]		PTFE	Stainless steel
DIN 11850 2 / DIN 11866 A / DIN EN 10357 A							
10	⅜	3	70(M)	0.1	13.0 x 1.5	-	250658
		4	70(M)	0.5	13.0 x 1.5	-	284171
		6	70(M)	1.2	13.0 x 1.5	-	284177
		8	70(M)	2.0	13.0 x 1.5	300236	284179
		10	70(M)	2.7	13.0 x 1.5	257412	208553
15	½	3	70(M)	0.1	19.0 x 1.5	-	225130
		4	70(M)	0.5	19.0 x 1.5	-	215257
		6	70(M)	1.2	19.0 x 1.5	-	215258
		8	70(M)	2.1	19.0 x 1.5	215250	215911
		10	70(M)	3.1	19.0 x 1.5	215251	215913
		15	70(M)	4.3	19.0 x 1.5	215253	209173
20	¾	15	70(M)	5.2	23.0 x 1.5	214113	208555
		20	70(M)	7.1	23.0 x 1.5	211937	211953
25	1	20	70(M)	7.2	29.0 x 1.5	214116	214154
		25	70(M)	12.0	29.0 x 1.5	209384	209089
32	1¼	25	90(N)	8.9	35.0 x 1.5	214119	214156
		32	90(N)	13.4	35.0 x 1.5	211965	209181
40	1½	32	90(N)	14.4	41.0 x 1.5	214121	213487
			130(P)	20.2	41.0 x 1.5	222711	222732
		40	90(N)	17.5	41.0 x 1.5	211967	209110
			130(P)	23.8	41.0 x 1.5	222713	222734
50	2	40	90(N)	18.0	53.0 x 1.5	214123	213411
			130(P)	24.6	53.0 x 1.5	222714	222735
		50	90(N)	28.0	53.0 x 1.5	211968	209185
			130(P)	37.0	53.0 x 1.5	214125	214159
65	2½	65	130(P)	65.0	70.0 x 2.0	219625	219628
80	3	80	130(P)	100.0	85.0 x 2.0	239544	239580
100	4	100	130(P)	140.0	104.0 x 2.0	239560	239596

Nominal diameter (pipe)	Seat size	Actuator size Ø	K _{vs} value	Connection Ø DS x WS	Operating pressure	Article no.	
						Seat seal	
NPS		[mm]	[m ³ /h]			PTFE (VI)	Stainless steel (IV)
ASME BPE/DIN 11866 C							
½	3	70(M)	0.1	12.7 x 1.65	25(IV)	–	353371 
	4	70(M)	0.5	12.7 x 1.65	25(IV)	–	226776 
	6	70(M)	1.2	12.7 x 1.65	25(IV)	–	316765 
	8	70(M)	2.0	12.7 x 1.65	25(IV)	379940 	216879 
	10	70(M)	2.7	12.7 x 1.65	25(IV)	225463 	313806 
¾	10	70(M)	3.1	19.05 x 1.65	25(IV)	241143 	On request
	15	70(M)	4.3	19.05 x 1.65	25(IV)	335739 	335741 
1	10	70(M)	3.2	25.4 x 1.65	25(IV)	241633 	242576 
	15	70(M)	5.2	25.4 x 1.65	25(IV)	226329 	242579 
	20	70(M)	7.1	25.4 x 1.65	16(IV)	230405 	216902 
1½	32	90(N)	13.4	38.1 x 1.65	16(IV)	230409 	242587 
		130(P)	17.8	38.1 x 1.65	25(IV)	242557 	242589 
2	40	90(N)	17.5	50.8 x 1.65	12(IV)	211655 	242592 
		130(P)	23.8	50.8 x 1.65	25(IV)	242561 	242593 
2½	50	130(P)	37.0	63.5 x 1.65	25(20*)(IV)	335735 	335737 
3	65	130(P)	65	76.2 x 1.65	16(15*)(IV)	268682 	350667 
4	80	130(P)	110	101.6 x 2.11	10(IV)	298386 	On request
	100	130(P)	140	101.6 x 2.11	6(IV)	275103 	289251 

Further versions on request

**Approval**

FDA, ATEX, (EG Gas Appliances Directive 2009/142/EG)

**Control function/Circuit function**

B (normally open: NO)

**Process connection**

Further housing connections

10.6. Ordering chart clamp connection

Valve with flow direction below seat

Nominal diameter (pipe)		Seat size	Actuator size Ø	K _{vs} value	Connection MC x TC, CC	Article no.	
[mm]	[inch]					Seat seal	
			[mm]	[m ³ /h]		PTFE	Stainless steel
DIN 32676 A							
15	½	15	70(M)	4.3	19 x 1.5, 34	222593 𐀀	282208 𐀀
20	¾	20	70(M)	7.1	23 x 1.5, 34	225647 𐀀	282209 𐀀
25	1	25	90(N)	12.0	29 x 1.5, 50.5	222594 𐀀	282210 𐀀
32	1¼	32	90(N)	13.4	35 x 1.5, 50.5	240415 𐀀	282211 𐀀
40	1½	40	130(P)	23.8	41 x 1.5, 50.5	240351 𐀀	282212 𐀀
50	2	50	130(P)	37.0	53 x 1.5, 64	282258 𐀀	282259 𐀀
DIN 32676 B							
15	½	15	70(M)	4.3	21.3 x 1.6, 50.5	273974 𐀀	282213 𐀀
20	¾	20	70(M)	7.1	26.9 x 1.6, 50.5	209438 𐀀	282214 𐀀
25	1	25	90(N)	12.0	33.7 x 2.0, 50.5	241115 𐀀	282215 𐀀
40	1½	40	130(P)	23.8	48.3 x 2.0, 64.0	209880 𐀀	284181 𐀀
50	2	50	130(P)	37.0	60.3 x 2.0, 77.5	282261 𐀀	282263 𐀀

Further versions on request

**Approval**

FDA, ATEX, (EG Gas Appliances Directive 2009/142/EG)

**Control function/Circuit function**

B (normally open: NO)

**Process connection**

Further housing connections

Bürkert – Close to You

For up-to-date addresses
please visit us at
www.burkert.com

DTS 1000112693 EN Version: AF Status: RL (released | freigegeben | validé) printed: 09.03.2023



Valve data		
Circuit Function	A: Normally closed	B: Normally open

Approvals / Conformities
For use with food (conform to EG regulation no. 1935/2004)
For use with food (conform to FDA)
Explosion protection in accordance with ATEX II 2GD mech. / IECex
European Gas Appliances Directive (EU) 2016/426, DVGW DIN EN 161 and DIN EN 16678
Suitable for drinking water ^{1.)}
Certificate for the fulfilment of the order EN-ISO 10204 2.1 (Article no. 440788)
Test report EN-ISO 10204 2.2 (Article no. 803722)
Conformity certification for raw material EN-ISO 10204 3.1 (included)



1.) For use with drinking water for medium temperatures up to 85 °C in accordance with the Drinking Water Ordinance §17 and the assessment principles of the Federal Environment Agency.

Additional Requirements / Comment

DTS 1000112693 EN Version: AF Status: RL (released | freigegeben | valide) printed: 09.03.2023

Positioner / process controller TopControl for control valves of the ELEMENT series

For actuator size $\varnothing 70/\varnothing 90/\varnothing 130$ mm

Process Controller TopControl Type 8693 ▶		Positioner TopControl Type 8692 ▶	
	<ul style="list-style-type: none"> Intelligent digital positioners and process controllers with integrated PID controller for accurate process control Lighted graphic display with membrane keypad Tune function for automatic start-up Field bus communication Diagnostic functions 		<ul style="list-style-type: none"> Digital positioner without sensor input Lighted graphic display with membrane keypad Tune function for automatic start-up Field bus communication Diagnostic functions
Pneumatic function Single-acting Double-acting		Electrical connection Cable gland M12 Multipole connection Without	
Digital Communication PROFIBUS DP-V1 EtherNet/IP PROFINET Bürkert Systembus (bùS) ^{1.)} Modbus TCP Without		Approvals ATEX cat. 3GD, IECEx Without	
Analogue feedback 0/4...20 mA 0/4...20 mA + 2 binary outputs		Digital outputs and diagnostics Yes No	

1.) Based on CANopen

For actuator size $\varnothing 70/\varnothing 90/\varnothing 130$ mm

For actuator size $\varnothing 50$ mm

Positioner TopControl BASIC Type 8694 ▶		Positioner TopControl BASIC Type 8696 ▶	
	<ul style="list-style-type: none"> Status LED and DIP switches Tune-function for automatic start-up Positioning system for single-acting actuators Field bus communication 		<ul style="list-style-type: none"> Status LED and DIP switches Tune-function for automatic start-up Positioning system for single-acting actuators
Pneumatic function Single-acting		Electrical connection Cable gland ^{1.)} M12 Multipole connection Without	
Digital Communication AS-Interface ^{1.)} IO-Link Bürkert Systembus (bùS) ^{2.)} Without		Approvals ATEX cat. 3GD, IECEx Without	
Analogue feedback Yes No			



1.) Only available for Type 8694. Not available for Type 8696.

2.) Based on CANopen

DTS 1000112693 EN Version: AF Status: RL (released | freigegeben | validé) printed: 09.03.2023

Positioner / process controller SideControl Remote for control valves of the ELEMENT series



For actuator size $\varnothing 70/\varnothing 90/\varnothing 130$ mm

Process Controller SideControl Type 8793 ▶ with Remote sensor Type 8798 ▶		Positioner SideControl Type 8792 ▶ with Remote sensor Type 8798 ▶	
	<ul style="list-style-type: none"> Intelligent digital positioners and process controllers with integrated PID controller Lighted graphic display with membrane keypad Tune-function for automatic start-up, linearization and optimization of process characteristics Field bus communication Diagnostic functions 		<ul style="list-style-type: none"> Digital positioner without sensor input Lighted graphic display with membrane keypad Tune function for automatic start-up Field bus communication Diagnostic functions
Pneumatic function		Electrical connection	
Single-acting	Single- and double-acting	Cable gland ^{1.)}	M12 Multipole connection
Digital communication		Approvals	
PROFIBUS DP-V1	EtherNet/IP	ATEX cat. 3GD, IECEx	Without
PROFINET	Bürkert Systembus (büS) ^{2.)}		
Modbus TCP	Without		
Analogue feedback		Digital outputs and diagnostics	
0/4...20 mA	0/4...20 mA + 2 binary outputs	Yes	No
0/5...10 V	0/5...20 V + 2 binary outputs		

1.) With a cable gland the selection of a fieldbus communication PROFIBUS, EtherNet etc. is not possible. Only variants with M12 Multipole are offered as standard for fieldbus communication.

2.) Based on CANopen

For actuator size $\varnothing 70/\varnothing 90/\varnothing 130$ mm

Positioner SideControl BASIC Type 8791 ▶ with Remote sensor Type 8798 ▶		Positioner SideControl BASIC IP20 Type 8791 ▶ with Remote sensor Type 8798 ▶	
	<ul style="list-style-type: none"> „simple positioner“ Universal positioning system for single and double acting actuators Tune function for automatic start-up Field bus communication 		<ul style="list-style-type: none"> „simple positioner“ Universal positioning system for single and double acting actuators Tune function for automatic start-up Switchgear cabinet assembly
Pneumatic function		Electrical connection	
Single-acting (actuator size $\varnothing 70/90$)	Single- and double-acting (actuator size $\varnothing 130$)	Cable gland ^{1.)}	M12 Multipole connection
Digital communication		Approvals	
AS-Interface ^{2.)} :		ATEX cat. 3GD, IECEx ^{2.)}	Without
Analogue profile S-7.3.4 (only set point)			
Analogue profile S-7.A.5 (set point and feedback)			
IO-Link	Bürkert Systembus (büS) ^{3.)} Without		
Analogue feedback			
0/4...20 mA	No		

1.) With a cable gland, the selection of a fieldbus communication AS-Interface is not possible. For fieldbus communication, only variants with M12 Multipole are offered as standard.

2.) Only available for Positioner SideControl BASIC Type 8791. Not available for Positioner SideControl BASIC IP20 Type 8791.

3.) Based on CANopen, IO-Link and büS not available for IP20 Type 8791