



## Control head for decentralized automation of hygienic process valves

- Universal attachment for hygienic process valves
- Contactless position measurement system with 3 switching points (Teach-In function)
- Coloured status display
- Manual override operative with closed housing
- AS-Interface, IO-Link, bÜS/CANopen

Product variants described in the data sheet may differ from the product presentation and description.

### Can be combined with



**Single seat valve**  
**Double seat valve**



**Butterfly valve** **Ball valve**

### Type description

The control head Type 8681 is optimized for decentralised automation of hygienic process valves. Thanks to its universal adapter it can be combined with all normal commercial butterfly valves, ball valves, single and double seated valves.

With a decentralised automation concept, the control head takes over all pneumatic actuation, feedback and diagnostic functions including field bus communication.

The housing is easy to clean and features proven IP protection and chemically resistant materials for use in hygienic processing in food, beverage and pharmaceutical industries.

Depending on the process valve type, up to 3 pneumatic actuator chambers can be controlled independently from each other. The switching speeds of both movement directions can be set separately. A built-in check valve prevents incorrect switching of process valve actuator chambers which could result from back-pressure.

The process valve switching positions are detected by an inductive, analogue position sensor and reported to the PLC system. Up to 3 switching points can be adjusted automatically by a Teach-In function. Additionally a fourth switching position can be read in and fed back via an external inductive proximity switch. The coloured status display signals the particular process valve switching position or indicates a diagnostic function such as maintenance required status or fault conditions.

The pilot valves are equipped with a manual override. If the device housing is closed, the patented magnetically encoded manual override tool can be used to open the process valve from the exterior. Bus communication is available with AS-interface, IO-Link or bÜS/CANopen.

## Table of contents

<b>1. General technical data</b>	<b>3</b>
1.1. Control head Type 8681 .....	3
1.2. Without fieldbus communication: 24 V DC .....	4
1.3. Without fieldbus communication: 120 V AC .....	5
1.4. With fieldbus communication: AS-Interface .....	6
1.5. With digital communication: IO-Link .....	7
1.6. With digital communication: büS/CANopen .....	8
1.7. Bit configuration table .....	8
1.8. Programming data table .....	8
1.9. Functional overview Type 8681 .....	9
<b>2. Approvals and conformities</b>	<b>10</b>
2.1. General notes .....	10
2.2. Conformity .....	10
2.3. Standards .....	10
2.4. Explosion protection .....	10
2.5. North America (USA/Canada) .....	10
<b>3. Materials</b>	<b>11</b>
3.1. Material specifications .....	11
3.2. Flange for process valve and target specification .....	11
<b>4. Dimensions</b>	<b>12</b>
4.1. Control head .....	12
4.2. Feedback version (without pilot valves) .....	13
4.3. Measuring range of piston rod and target .....	14
4.4. Accessories .....	14
<b>5. Device/Process connections</b>	<b>15</b>
5.1. Electrical connection .....	15
Without fieldbus communication: 24 V DC .....	15
Without fieldbus communication: 120 V AC .....	16
AS-Interface connection .....	17
IO-Link connection .....	18
Bürkert system bus büS/CANopen connection .....	19
Pneumatic connection .....	20
<b>6. Product operation</b>	<b>20</b>
6.1. Magnetic manual override .....	20
Activation / Deactivation solenoid valve 1 (process valve maintenance function) .....	20
<b>7. Ordering information</b>	<b>21</b>
7.1. Bürkert eShop .....	21
7.2. Bürkert product filter .....	21
7.3. Ordering chart .....	22
7.4. Ordering chart accessories .....	24
Standard accessories .....	24
Special accessories for Type 8681 büS/CANopen .....	24

DTS 1000140628 EN Version: N Status: RL (released | freigegeben | validé) printed: 11.12.2023

## 1. General technical data

### 1.1. Control head Type 8681

<b>Product properties</b>	
Dimensions	Further information can be found in chapter "4. Dimensions" on page 12.
<b>Material</b>	
Body	PA, PPO, VA, stainless steel
Seal	PC
Cover	CR, EPDM
<b>Operation</b>	
Operating keys	Teach keys
DIP switch	Yes
Service interface	Connection with PC via USB connection
Configuration tool	Bürkert Communicator or PC service programme (according to device version)
<b>Commissioning</b>	
Setting valve end position	Through automatic or manual teach function
Manual override of pilot valve	Yes
<b>Status display</b>	
Display of device and valve status	High-power LEDs (colours individually adjustable)
<b>Communication</b>	
Fieldbus	AS-Interface
Digital	IO-Link, Bürkert system bus (based on CANopen)
<b>Fieldbus specific data</b>	
Bit configuration table	Further information can be found in chapter "1.7. Bit configuration table" on page 8.
Programming data table	Further information can be found in chapter "1.8. Programming data table" on page 8.
<b>Performance data</b>	
Functional overview	Further information can be found in chapter "1.9. Functional overview Type 8681" on page 9.
<b>Position sensor</b>	
Analogue position sensor	Inductive (contactless), 3 self-regulated switching points PNP (Teach resp. autotune function), closer (normally open), PNP output short circuit proof, clocking short circuit protection
<b>Stroke range for linear actuator</b>	
Valve spindle	0...80 mm
<b>Position feedback</b>	
Output current	Max. 100 mA per feedback signal
Resolution	≤0.1 mm
Total error	±0.5 mm when using a target for the dimensional drawing, (material 1.4021) and a piston rod (Ø 22 mm, material 1.4301) (error refers to the reproducibility of the teach position)
<b>Pneumatic data</b>	
<b>Control medium</b>	<b>Neutral gases, air, quality class according to ISO 8573 - 1</b>
Dust content	Class 7 (<40 µm particle size)
Particle density	Class 7 (<10 mg/m <sup>3</sup> )
Pressure dew point	Class 3 (<-20 °C)
Oil content	Class X (<25 mg/m <sup>3</sup> )
Supply pressure	2.5...8 bar
<b>Pilot air port</b>	
Air inlet and outlet	G ¼
Service port	G ⅛

<b>Actuating system</b>	
Circuit function	Single-acting and double-acting
Air performance <sup>1.)</sup>	110 l <sub>N</sub> /min for aeration and ventilation 110 l <sub>N</sub> /min delivery condition 200 l <sub>N</sub> /min maximum typical flow rate
<b>Approvals and conformities</b>	
<b>Explosion protection</b>	
ATEX	Dust: II 3 D Ex tc IIIC T135 °C Dc X Gas: II 3 G Ex ec IIC T4 Gc X Further information can be found in chapter "2.4. Explosion protection" on page 10.
<b>North America (USA/Canada)</b>	
UL Listed for the USA and Canada	cULus-Zertifikat: E238179
FM Explosion Protection	Nonincendive for Class I, Division 2, Groups A, B, C and D hazardous locations
Further information can be found in chapter "2.5. North America (USA/Canada)" on page 10.	
<b>Environment and installation</b>	
<b>Operating conditions</b>	
<b>Ambient temperature</b>	<b>- 10 to +55 °C</b> <b>+5 to +55 °C (in Ex atmosphere (Zone 2))</b>
Degree of protection	IP65/67 according to EN 60529
Operating altitude	Up to 2000 m above sea level
<b>Installation and mechanical data</b>	
Installation position	As required, preferably with actuator in upright position

1.) Q<sub>Nm</sub>-value for pressure drop from 7 to 6 bar absolute at 20 °C

## 1.2. Without fieldbus communication: 24 V DC

<b>Electrical data</b>	
Operating voltage	12 bis 28 V DC
Residual ripple	Max. 10 %
Protection class	III according to DIN EN 61140
Power consumption	<5 W (according to version and operating status, see <b>operating manual Type 8681</b> ▶)
<b>Inputs valve control (Y1 - Y3)</b>	
Signal level active	U > 10 V, max. 24 V DC + 10 %
Signal level inactive	U < 5 V
Impedance	U > 30 kOhm
<b>Outputs/binary feedback signal (S1 OUT - S4 OUT)</b>	
Design	Closer (normally open), PNP output short circuit proof, self-locking short circuit protection
Switchable output current	Max. 100 mA per feedback signal
Output voltage active	≥ Operating voltage - 2 V
Output voltage inactive	Max. 1 V in unloaded state
<b>Input / proximity switch (external initiator: S4 I<sub>N</sub>)</b>	
Operating voltage	Voltage applied at control head - 10 %
Current carrying capacity, sensor operating voltage	Max. 90 mA short circuit protection
Design	DC 2-wire and 3-wire, NO or NC (factory setting NO), PNP output
Input current 1 signal	I <sub>Sensor</sub> > 6.5 mA, limited internally to 10 mA
Input voltage 1 signal	U <sub>Sensor</sub> > 10 V
Input current 0 signal	I <sub>Sensor</sub> < 4 mA
Input voltage 0 signal	U <sub>Sensor</sub> < 5 V
<b>Electrical connection</b>	
Multipole	M12, 12-pin with 8 cm cable, 1 x M16 x 1.5 cable glands for external initiator (clamping range 3...6 mm)
Cable gland	M16 x 1.5 (cable Ø 5...10 mm, screw terminals 0.14...1.5 mm <sup>2</sup> ), 1 x M16 x 1.5 cable glands for external initiator (clamping range 3...6 mm)

### 1.3. Without fieldbus communication: 120 V AC

<b>Electrical data</b>	
Operating voltage	110...130 V AC/50/60 Hz
Protection class	I according to DIN EN 61140
Current consumption (stand by current)	10 mA at 120 V AC
<b>Input, valve control (Y1 - Y3)</b>	
Signal level active	U > 60 V AC
Signal level inactive	U < 20 V AC
Impedance	> 40 Ω
<b>Output/binary feedback signal S1 OUT - S3 OUT</b>	
Design	Closer (normally open), L-switching, short circuit protection via automatically resetting fuse
Switchable output current	Max. 50 mA per feedback signal
Output voltage active	≥ operating voltage - 2 V
Output voltage inactive	Max. 1 V in unloaded state
<b>Input/proximity switch (external initiator: S4 I<sub>N</sub>)</b>	
Operating voltage	Voltage applied at control head: U <sub>Nominal</sub> = 120 V AC, 50/60 Hz
Current carrying capacity sensor operating voltage	Max. 0.7 A
Design	DC 2 and 3 wire, NO contact, L switching
Input current 1-Signal	I <sub>Sensor</sub> < 2 mA
<b>Electrical connection</b>	
Cable gland	M16 x 1.5 (cable Ø 5...10 mm, screw terminals 0.14...1.5 mm <sup>2</sup> ), 1 x M16 x 1.5 cable glands for external initiator (clamp range 3...6 mm)

#### 1.4. With fieldbus communication: AS-Interface

Product properties	
Profile	S- 7.A.E (AB slave max. 62 slaves/master) S- 7.F.F (max. 31 Slaves/Master)
Electrical data	
Operating voltage	
Via bus cable	According to specification
Isolated from bus signal	Reversible (jumper)
Protection class	III according to DIN EN 61140
Power consumption equipment without external operating voltage	
Maximum current consumption	< 160 mA (including external initiator with 30 mA)
Current consumption in normal operation	< 150 mA
(after power reduction of the valves + 1 end position reached)	3 valves activated, 1 position feedback with LED display, no external initiator
Current consumption device with external operating voltage	
The operating voltage unit must contain a safe disconnection according to IEC 60364 - 4 - 41.	19.2 V DC to 31.6 V DC ≤ 110 mA 24 V DC ≤ 150 mA typical
It must comply with the SELV standard. The ground potential must not have an earth connection.	
Output (from master perspective)/solenoid valve	
Contact rating	Max. 0.9 W per solenoid valve for 200 ms after switching on
Typical contact rating	0.6 W per solenoid valve from 200 ms after switching on
Watchdog function	Integrated
Typical inrush current per solenoid valve	30 mA resp. 0.9 W/200 ms (at 30.5 AS-i voltage)
Typical hold current per solenoid valve	20 mA resp. 0.6 W/200 ms (at 30.5 AS-i voltage)
Operating mode	Continuous operation (100 % duty cycle)
Valve type	6524
Input/proximity switch (external initiator: S4 I <sub>N</sub> )	
Operating voltage	AS-Interface voltage applied at control head - 10 %
Current carrying capacity of sensor operating voltage	Max. 30 mA short circuit protection
Design	DC 2- and 3-wire, NO or NC (factory setting NO), PNP output
Input current 1 signal	$I_{\text{Sensor}} > 6.5 \text{ mA}$ , limited internally to 10 mA
Input voltage 1 signal	$U_{\text{Sensor}} > 10 \text{ V}$
Input current 0 signal	$I_{\text{Sensor}} < 4 \text{ mA}$
Input voltage 0 signal	$U_{\text{Sensor}} < 5 \text{ V}$
Electrical connection (standard: AS-i flat cable clip at 80 cm cable)	
Multipole	M12, 4-pin on 8 cm cable (resp. 0.3 m cable length according to AS-Interface specification) or on 80 cm cable (resp. 1.0 m cable length according to AS-Interface specification)
Cable gland	1 x M16 x 1.5 for external initiator (clamp range 3...6 mm)

### 1.5. With digital communication: IO-Link

Electrical data	
IO-Link revision	1.1
SIO mode	No
VendorID	0x78, 120
DeviceID	See corresponding IODD file (Port Class A, resp. Port Class B) The IODD file can be downloaded from our <a href="#">website Type 8681</a> ▶, see Software > Device Description Files A.04.
Transmission rate	230.4 kbit/s
Frame type in operation	TYPE_2_V
Cycle time	Min. 2 ms
Data Storage	Yes
Cable length	Max. 20 m
Port Class	A resp. B
Operating voltage	18 bis 30 V DC (according to specification)
Operating voltage	Via IO-Link
Protection class	III according to DIN EN 61140
Maximum current consumption	
Port Class A	< 170 mA at 18 V, without external initiator for 3 solenoid valves
Port Class B	< 65 mA at 18 V, without external initiator from power 1, < 100 mA at 18 V for 3 valves from power 2
Current consumption in normal operation (after power reduction of the 3 solenoid valves + 1 end position reached)	
Port Class A	< 155 mA at 18 V, without external initiator at 3 solenoid valves
Port Class B	< 65 mA at 18 V, without external initiator from power 1, < 85 mA at 18 V for 3 solenoid valves from power 2
Output (from master perspective)/solenoid valves	
Contact rating	Max. 0.9 W (per solenoid valve)
Typical continuous output	0.6 W (per solenoid valve)
Inrush current	40 mA resp. 0.9 W/200 ms (for voltage rating 24 V)
Hold current	25 mA resp. 0.6 W (for voltage rating 24 V)
Operating mode	Continuous operation (100 % duty cycle)
Input/proximity switch (external initiator: S4 I <sub>n</sub> ) solenoid valves	
Operating voltage	Voltage at power 1...10 %
Current carrying capacity sensor operating voltage	Max. 30 mA, short circuit protection
Design	DC 2- and 3-wire, NO, PNP output
Input current 1 signal	$I_{\text{Sensor}} > 6.5 \text{ mA}$ , limited internally to 10 mA
Input voltage 1 signal	$U_{\text{Sensor}} > 10 \text{ V}$
Input current 0 signal	$I_{\text{Sensor}} < 4 \text{ mA}$
Input voltage 0 signal	$U_{\text{Sensor}} < 5 \text{ V}$
Electrical connection	
Multipole	M12, 4-pin (IO-Link, Port Class A) M12, 5-pin (IO-Link, Port Class B)
Cable gland	M16 x 1.5 (clamp range 5...10 mm, screw terminals 0.14...1.5 mm <sup>2</sup> ) 1 x cable gland M16 x 1.5 (clamp range 3...6 mm, screw terminals 0.14...1.5 mm <sup>2</sup> ) for external initiator

## 1.6. With digital communication: büS/CANopen

Electrical data	
<b>Power supply</b>	<b>11...25 V DC</b>
Protection class	III according to DIN EN 61140
Current consumption	< 180 mA at 24 V DC
<b>Output (from master perspective)/solenoid valve</b>	
Typical contact rating	0.9 W per solenoid valve for 200 ms after switching on
Typical continuous output	0.6 W per solenoid valve from 200 ms after switching on
Power reduction	Via the büS/CANopen interface, electronically integrated
Typical inrush current per solenoid valve	38 mA resp. 0.9 W/200 ms at 24 V DC
Typical hold current per solenoid valve	75 mA typically at 24 V DC (3 solenoid valves)
Operating mode	Continuous operation (100 % duty cycle)
Valve type	6524
<b>Input/proximity switch (external initiator: S4 I<sub>N</sub>)</b>	
Operating voltage	Via the büS/CANopen operating voltage - 10 %
Current carrying capacity of sensor operating voltage	Max. 30 mA
Short circuit protection design	DC 2- and 3-wire, closer (NO), PNP output
Input current 1 signal	$I_{\text{Sensor}} > 6.5 \text{ mA}$ , limited internally to 10 mA
Input voltage 1 signal	$U_{\text{Sensor}} > 10 \text{ V}$
Input current 0 sSignal	$I_{\text{Sensor}} < 4 \text{ mA}$
Input voltage 0 signal	$U_{\text{Sensor}} < 5 \text{ V}$
Electrical connection	
Multipole	M12, 5-pin on 80 cm cable, 1 x M16 x 1.5 cable gland for external initiator (clamp range 3...6 mm)
Cable gland	1 x M16 x 1.5 cable gland (clamping range 5...10 mm), 1 x M16 x 1.5 cable gland for external initiator (clamp range 3...6 mm)

## 1.7. Bit configuration table

Bit assignment				
Databit	D3	D2	D1	D0
Input	External initiator S4	Position 3	Position 2	Position 1
Output	Not assigned	Solenoid valve 3	Solenoid valve 2	Solenoid valve 1
Parameterbit	D3	D2	D1	D0
Output	Not assigned	Not assigned	Not assigned	Not assigned

## 1.8. Programming data table

Programming data		
Databit	Programming data with 62 slaves AS-Interface – Device for AB slave addressing (standard device)	Programming data with 31 slaves AS-Interface (optional)
E/A-Configuration	7 hex (4 inputs/4 outputs) see “1.7. Bit configuration table” on page 8	7 hex (4 inputs/4 outputs) see “1.7. Bit configuration table” on page 8
ID-Code	A hex	F hex
Extended ID Code 1	7 hex	(F hex)
Extended ID Code 2	E hex	(F hex)
Profile	S-7.A.E	S-7.F.F



## 1.9. Functional overview Type 8681

Function	Version					
	24 V DC	120 V AC	AS-Interface standard slave	AS-Interface AB slave	IO-Link	büS/ CANopen
<b>Basic functions</b>						
Teach function of the position measuring system for 3 definable teach points (S1, S2, S3) <sup>1.)</sup>	–	X	X	X	X	X
Manual override of pilot valve (mechanical)	X	X	X	X	X	X
Manual override, magnetic (for pilot valve MV1 = 2/A1)	X	X	X	X	X	X
Position feedback process valve OPEN/CLOSED <sup>2.)</sup>	X	X	X	X	X	X
Feedback signal current valve position (intermediate position)	–	–	–	–	X <sup>3.)</sup>	X <sup>4.)</sup>
Optical position feedback of teach points (S1, S2, S3) and S4 <sup>1.)</sup>	X	X	X	X	X	X
Colour change of the optical position feedback possible	X	X	X	X	X	X
Selection of LED display modes	–	–			X	X
Diagnosis LEDs (on the electronic module)	–	–	X	X	X	X
Locating function	–	–	–	–	X	X
büS communication interface (Bürkert system bus)	–	–	–	–	X	X
büS service interface (for Bürkert Communicator software)	X	X	X	X	–	–
<b>Diagnosis</b>						
Counter switching cycles of pilot valve MV1...3 with definable limit value	X	X	X	X	X	X
Counter operating hours with definable limit value	X	X	X	X	X	X
Maintenance / service notification (feedback when selected limit values are exceeded)	X	X	X	X	X	X
Active diagnostic messages	–	–	–	–	X	X
Device reset	X	X	X	X	X	X
Feedback Teach error	X	X	X	X	X	X
Feedback overtemperature	–	–	–	–	X	X
Feedback communication error	–	–	X	X	X	X
Feedback for opening/closing timeout	–	–	–	–	X	–
Tolerance for switching time overrun	–	–	–	–	X	–
Error detection if the setpoint position is not reached (end positions not reached)	–	–	–	–	X	–
Detection of under-voltage and over-voltage of operating voltage	–	–	–	–	X	–
Trigger maintenance function	–	–	–	–	X	X
Tolerance band of end position detection	X	X	X	X	X	X
Log function for error cases (via Bürkert Communicator)	–	–	–	–	X	X
<b>Parameterisation</b>						
Parameterisation via Bürkert Communicator (service interface on electronic module)	X	X	X	X	–	–
<b>Parameterisation via büS communication interface</b>						
Activation/deactivation safety position in case of bus error	–	–	X	X	X	X
Fail-safe positions are defined in case of power and compressed air failure	X	X	X	X	X	X
Activation/deactivation of the magnetic manual override	X	X	X	X	X	X
Deactivation of local operation (lock function)	–	–	–	–	X	X
Factory reset function (reset to factory setting)	X	X	X	X	X	X

- 1.) S1 - mostly lower valve position (valve completely closed)  
 S2 - mostly upper valve position (valve fully open)  
 S3 - mostly specific intermediate position (e.g. upper cycle stroke for double-seat valves)  
 S4 - external feedback/initiator (e.g. lower cycle stroke for double-seat valves)
- 2.) OPEN/CLOSED via S1/S2/intermediate position via S3/external feedback/initiator via S4
- 3.) Specification for I/O link in mm with 0.1 mm resolution
- 4.) Specification for büS/CANopen in mm with 1 mm resolution

## 2. Approvals and conformities

### 2.1. General notes

- The approvals and conformities listed below must be stated when making enquiries. This is the only way to ensure that the product complies with all required specifications.
- Not all available versions can be supplied with the below mentioned approvals or conformities.

### 2.2. Conformity

In accordance with the Declaration of Conformity, the product is compliant with the EU Directives.

### 2.3. Standards

The applied standards which are used to demonstrate compliance with the EU Directives are listed in the EU-Type Examination Certificate and/or the EU Declaration of Conformity.

### 2.4. Explosion protection

Approval	Description				
	<b>Optional: Explosion protection</b>  ATEX:				
	<table border="1"> <thead> <tr> <th>Dust</th> <th>Gas</th> </tr> </thead> <tbody> <tr> <td>II 3 D Ex tc IIIC T135 °C Dc X</td> <td>II 3 G Ex ec IIC T4 Gc X</td> </tr> </tbody> </table>	Dust	Gas	II 3 D Ex tc IIIC T135 °C Dc X	II 3 G Ex ec IIC T4 Gc X
	Dust	Gas			
II 3 D Ex tc IIIC T135 °C Dc X	II 3 G Ex ec IIC T4 Gc X				

### 2.5. North America (USA/Canada)

Approval	Description
	<b>Optional: UL Listed for the USA and Canada</b> The products are UL Listed for the USA and Canada according to: <ul style="list-style-type: none"> <li>• UL 61010-1 (ELECTRICAL EQUIPMENT FOR MEASUREMENT, CONTROL, AND LABORATORY USE – Part 1: General Requirements)</li> <li>• CAN/CSA-C22.2 No. 61010-1</li> </ul>
	<b>Optional: FM (Factory Mutual) – Explosion Protection</b> Nonincendive for Class I, Division 2, Groups A, B, C and D hazardous locations

DTS 1000140628 EN Version: N Status: RL (released | freigegeben | validé) printed: 11.12.2023

### 3. Materials

#### 3.1. Material specifications

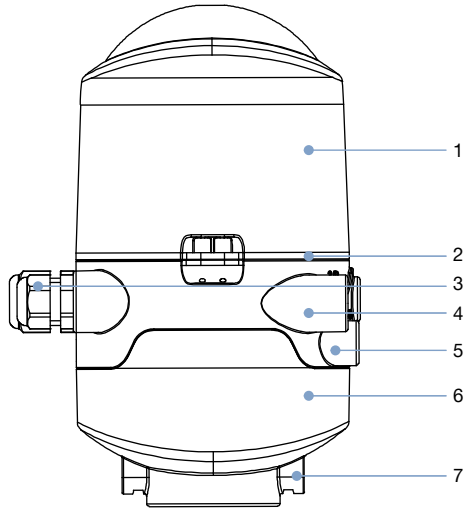

No.	Element	Material
1	Cover	PC
2	Seals	EPDM, CR
3	Cable glands	PA
4	Fluid part	PPO
5	Screws/Threaded ports	Stainless steel
6	Lower part of body	PPO
7	Screws/Threaded ports	Stainless steel

#### 3.2. Flange for process valve and target specification

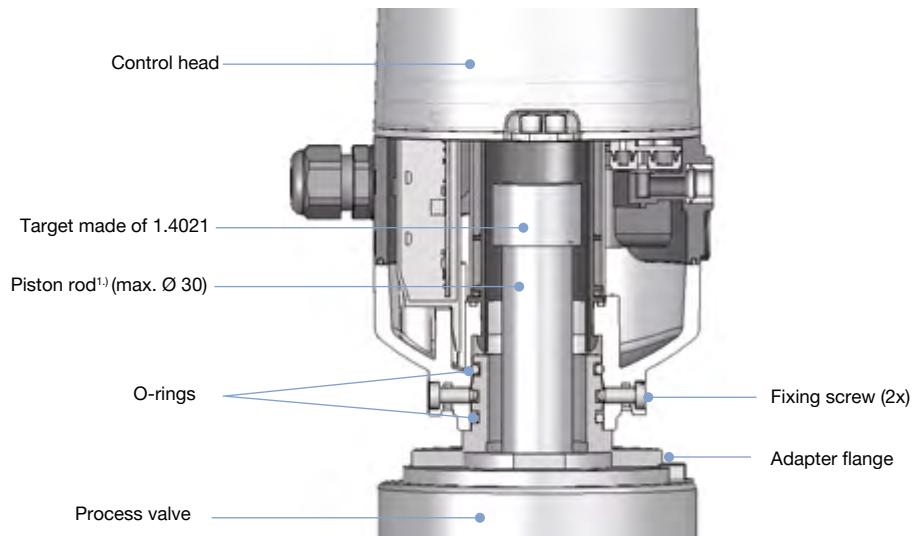

1.) Target and piston should not be made of ferromagnetic material or material with high electrical conductivity (e.g. copper, aluminium). Stainless steel without ferromagnetic properties such as 1.4404 is suitable (if necessary verify after processing).

DTS 1000140628 EN Version: N Status: RL (released | freigegeben | validé) printed: 11.12.2023

## 4. Dimensions

### 4.1. Control head

**Note:**

Dimensions in mm

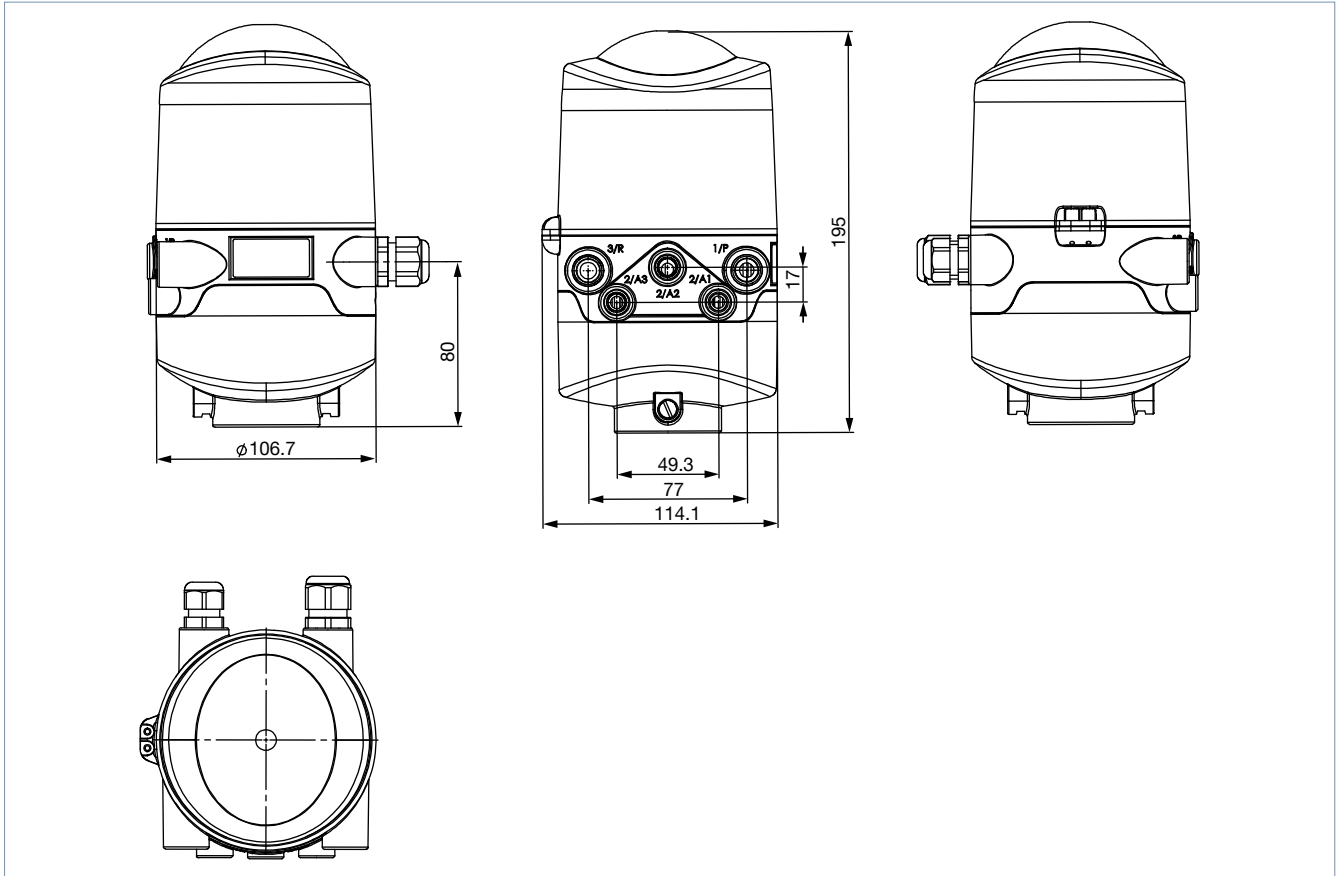

**4.2. Feedback version (without pilot valves)**

**Note:**

Dimensions in mm

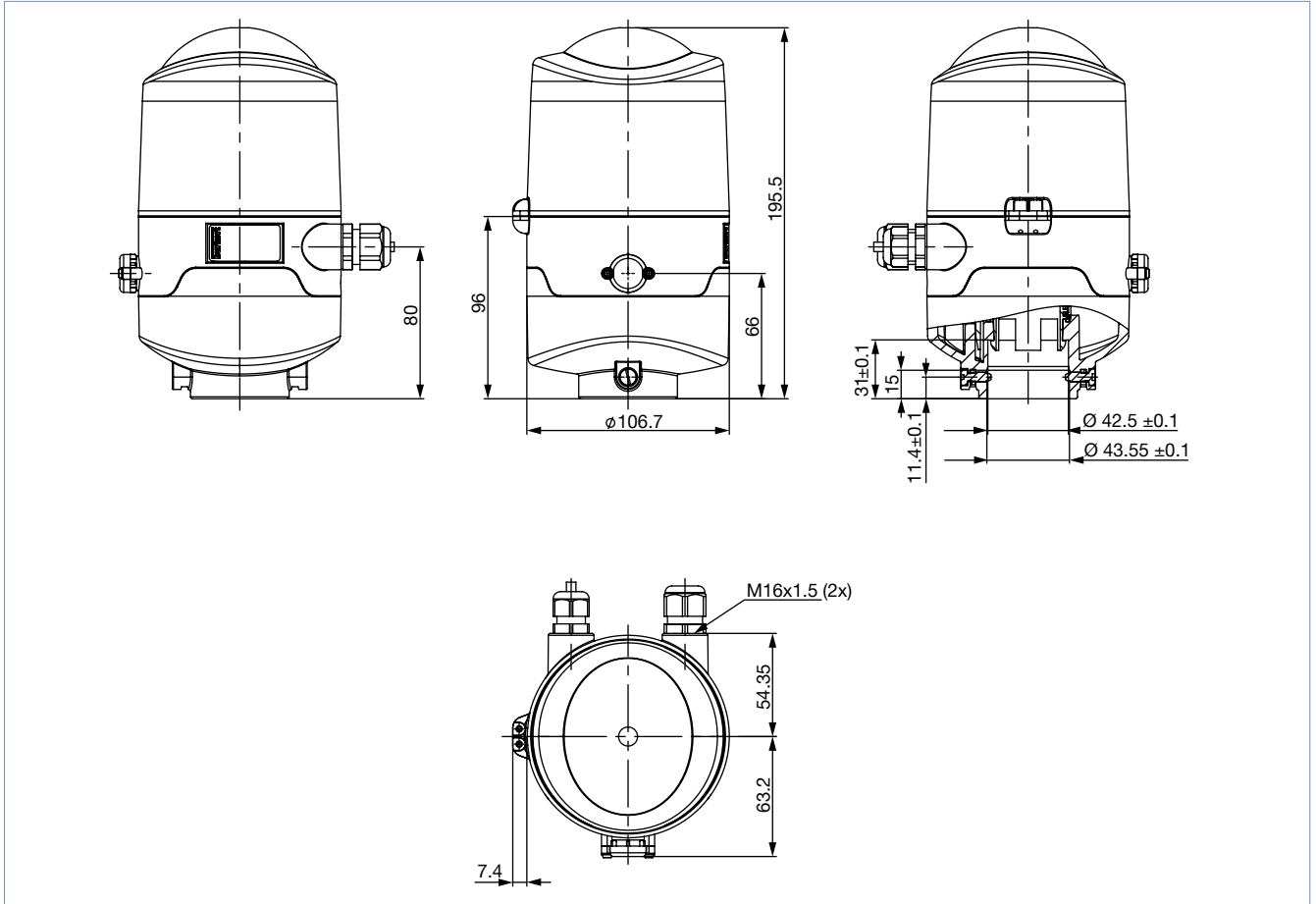

### 4.3. Measuring range of piston rod and target

**Note:**

Dimensions in mm

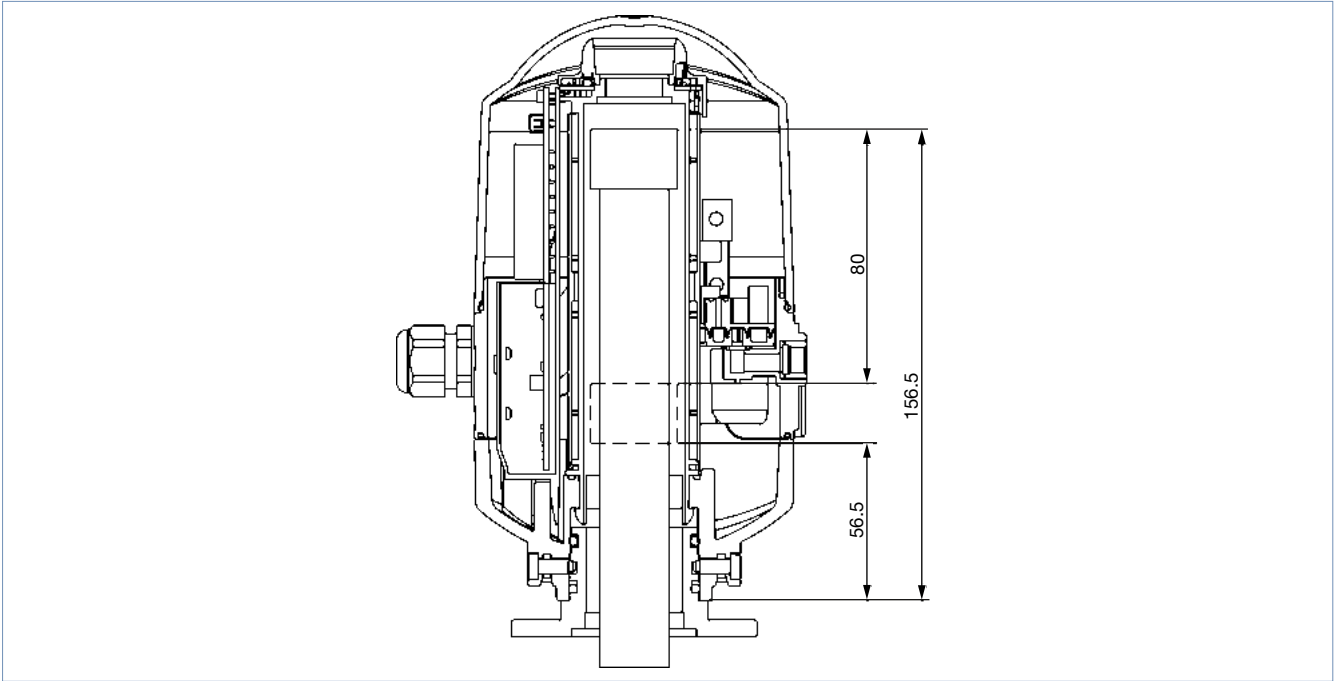

### 4.4. Accessories

**Note:**

- Dimensions in mm
- For in-house production of a flange adapter, please request a detailed dimensional drawing.

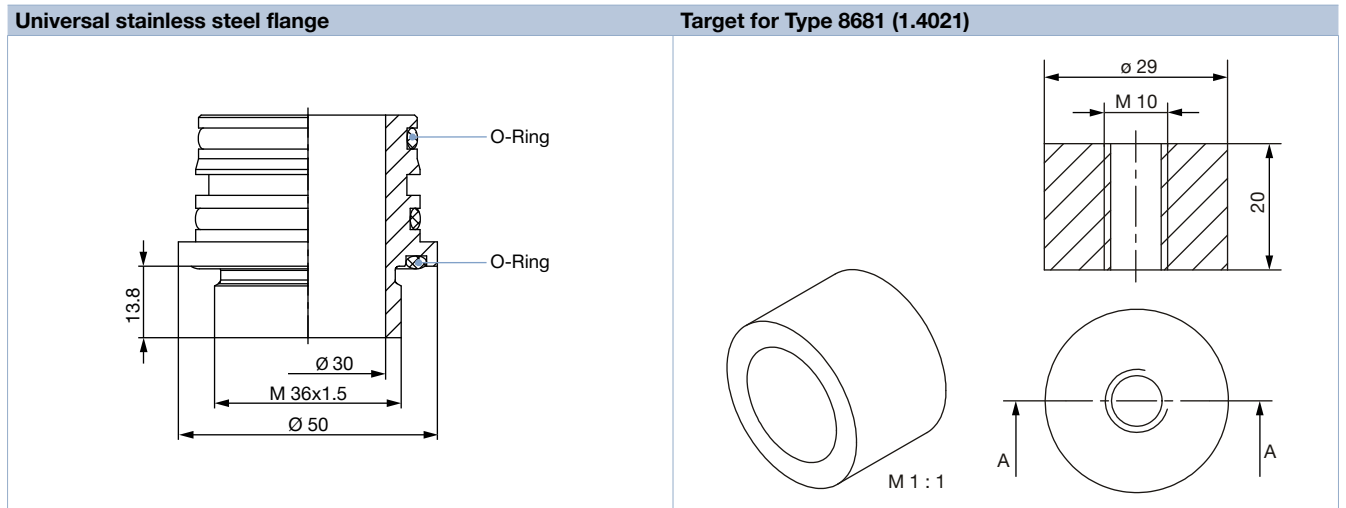

DTS 1000140628 EN Version: N Status: RL (released | freigegeben | validé) printed: 11.12.2023

## 5. Device/Process connections

### 5.1. Electrical connection

Without fieldbus communication: 24 V DC

Cable glands		Version with 12-pin plug (for 24 V) <sup>1.)</sup>	
Connection left: Voltage, signals	Connection right: External initiator	Connection left: Voltage, signals	Connection right: External initiator

1.) M12 plug according to IEC 61076-2-101, 12-pin with 8 cm cable

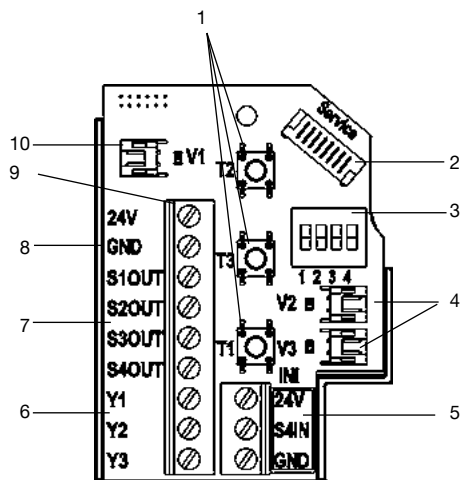

Pin	Description	Pin assignment
1	T1 T2 T3	Teach keys
2	Service	Service interface
3	-	DIP button for colour coding of LEDs
4	V2 V3	Solenoid valve connection with status LED for valves 2, 3
5	24 V S4IN GND	Connection of the external initiators
6	Y1 Y2 Y3	Control unit solenoid valve Y1...3
7	S1 OUT S2 OUT S3 OUT S4 OUT	Feedback signals S1...4 OUT
8	GND	Operating voltage
9	-	Terminal strip
10	-	Solenoid valve connection with status LED for valve 1

Description terminal strip	Pin assignment	Description terminal strip	Pin assignment
24 V	Operating voltage 24 V	24 V	Operating voltage 24 V for external initiator
GND	GND	S4 I <sub>N</sub>	Input external initiator
S1 OUT	Output position 1	GND	GND external initiator
S2 OUT	Output position 2		
S3 OUT	Output position 3		
S4 OUT	Output external initiator		
Y1	Solenoid valve input 1		
Y2	Solenoid valve input 2		
Y3	Solenoid valve input 3		

**Multipole connection M12, 12-pin input and output signals to the higher level control system (SPS)**  
**12-pin circular plug connector M12 x 1.0 (according to IEC 61076-2-101)**

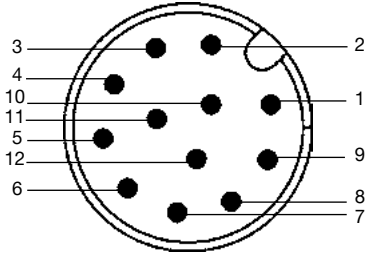

Pin	Description	Pin assignment
1	24 V	Operating voltage 24 V
2	GND	GND
3	S1 OUT	Output position S1
4	S2 OUT	Output position S2
5	S3 OUT	Output position S3
6	S4 OUT	Output external initiator S4
7	Y1	Solenoid valve input 1
8	Y2	Solenoid valve input 2
9	Y3	Solenoid valve input 3
10	-	Not assigned
11	-	Not assigned
12	-	Not assigned

**Without fieldbus communication: 120 V AC**

**Cable gland**

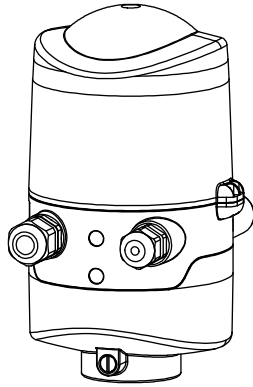

Connection left:  
Voltage, signals

Connection right:  
External initiator

Description terminal strip 1	Pin assignment	
PE	Protective earth conductor	
L	Operating voltage	Conductor
N	120 V AC	Neutral conductor
S1 OUT	Output position 1	
S2 OUT	Output position 2	
S3 OUT	Output position 3	
S4 OUT	Output external initiator	
Y1	Solenoid valve input 1	
Y2	Solenoid valve input 2	
Y3	Solenoid valve input 3	
Description terminal strip 2	Pin assignment (external initiator)	
L	Operating voltage, live conductor	
S4 I <sub>N</sub>	Input external initiator	
N	Operating voltage, neutral conductor	



**AS-Interface connection**

With multipole connection <sup>1.)</sup>		With multipole connection	
M12 plug according to IEC 61076-2-101, 4-pin on 8 cm cable		M12 plug according to IEC 61076-2-101, 4-pin with mounted AS-i flat cable clip on 80 cm cable	
Connection left: AS-Interface	Connection right: External initiator	Connection left: AS-Interface	Connection right: External initiator

1.) On request

M12 circular plug, 4-pin				M12 circular plug, 4-pin			
Bus connection operating voltage via bus				Bus connection with external operating voltage			
Pin	Description	Pin assignment	Wire colour	Pin	Description	Pin assignment	Wire colour
1	ASI +	AS-Interface - AS-i +	Brown	1	ASI +	AS-Interface - AS-i +	Brown
2	NC	Not assigned	White	2	GND	GND	White
3	ASI -	AS-Interface - AS-i -	Blue	3	ASI -	AS-Interface - AS-i -	Blue
4	NC	Not assigned	Black	4	24 V +	24 V +	Black

DTS 1000140628 EN Version: N Status: RL (released | freigegeben | validé) printed: 11.12.2023

**IO-Link connection**

Multipole connection		Cable gland	
M12 plug according to IEC 61076-2-101, 4-pin (Port Class A) or 5-pin (Port Class B) on a 15 cm cable		M16 x 1.5 (SW22)	
Connection left: Voltage, signals (IO-Link connection)	Connection right: External initiator	Connection left: Voltage, signals (IO-Link connection)	Connection right: External initiator

M12 circular plug, 4-pin, Port Class A		Pin	Description	Pin assignment	Wire colour
		1	L+	24 V DC	Brown
		2	DIO/2L+	Not assigned	(White)
		3	L-	0 V (GND)	Blue
		4	C/Q	IO-Link	Black

M12 circular plug, 5-pin, Port Class B		Pin	Description	Pin assignment	Wire colour
		1	L+	24 V DC (Power 1)	Brown
		2	DIO/2L+	24 V DC (Power 2)	White
		3	L-	0 V (GND, Power 1)	Blue
		4	C/Q	IO-Link	Black
		5	2M	0 V (GND, Power 2)	Grey or yellow/green

DTS 1000140628 EN Version: N Status: RL (released | freigegeben | validé) printed: 11.12.2023

**Bürkert system bus büS/CANopen connection**

**Multipole**

Connection left: büS/CANopen      Connection right: External initiator

**M12 circular plug, 5-pin**

Pin	Description	Wire colour
1	Shielding	Shielding
2	V+	Red
3	V-	Black
4	CAN_H	White
5	CAN_L	Blue

**Cable gland**

Description terminal strip 1	Wire colour	Pin assignment
V+	Red	Operating voltage büS/CANopen
V-	Black	Operating voltage büS/CANopen
CAN_H	White	Bus signal CAN high
CAN_L	Blue	Bus signal CAN low
Description terminal strip 2	Pin assignment	
V+	Operating voltage for external initiator	
S4 I <sub>N</sub>	Input external initiator	
GND	GND external initiator	

Connection left: Voltage, signals      Connection right: External initiator

DTS 1000140628 EN Version: N Status: RL (released | freigegeben | validé) printed: 11.12.2023

**Pneumatic connection**

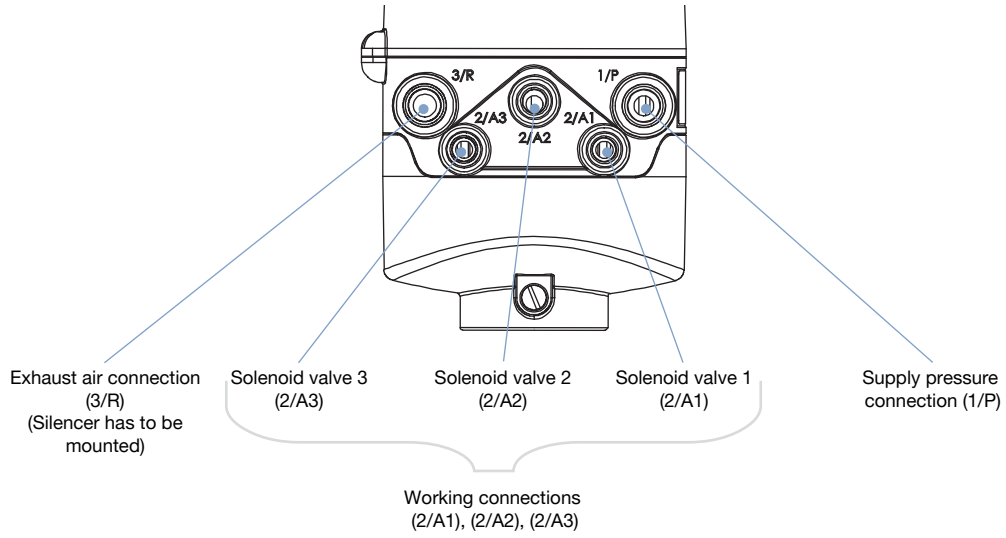

## 6. Product operation

### 6.1. Magnetic manual override

Activation / Deactivation solenoid valve 1 (process valve maintenance function)

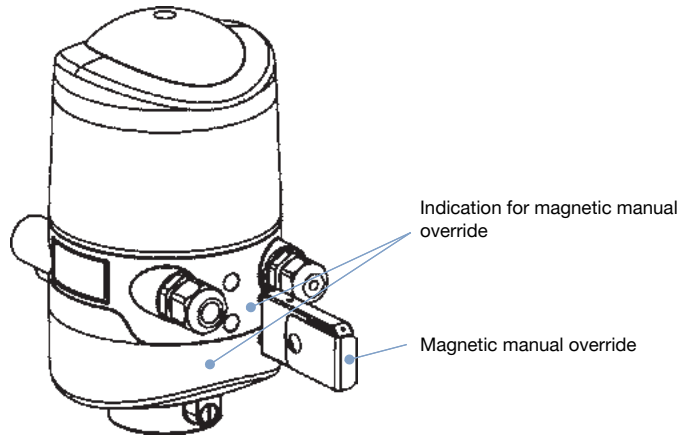

## 7. Ordering information

### 7.1. Bürkert eShop



#### Bürkert eShop – Easy ordering and quick delivery

You want to find your desired Bürkert product or spare part quickly and order directly? Our online shop is available for you 24/7. Sign up and enjoy all the benefits.

[Order online now](#)

### 7.2. Bürkert product filter



#### Bürkert product filter – Get quickly to the right product

You want to select products comfortably based on your technical requirements? Use the Bürkert product filter and find suitable articles for your application quickly and easily.

[Try out our product filter](#)

























7.3. Ordering chart

Note:

Further versions are available on request.

Communi- cation	Operating voltage	Connection	ATEX Zone 2/22 Cat. 3	FM NI Class I Division 2	cULus	Number of solenoid valves	Position feedback	Article no.		
Analogue	12...28 V DC	Cable gland	-	-	-	0	3 int. + 1 ext.	196410		
			-	-	-	1	3 int. + 1 ext.	196411		
			-	-	-	2	3 int. + 1 ext.	196412		
			-	-	-	3	3 int. + 1 ext.	196413		
			Yes	-	-	1	3 int. + 1 ext.	196415		
	12...28 V DC	M12, 12-pin, 8 cm cable	-	-	-	0	3 int. + 1 ext.	196420		
			-	-	-	1	3 int. + 1 ext.	196421		
			-	-	-	2	3 int. + 1 ext.	196422		
			-	-	-	3	3 int. + 1 ext.	196423		
			Yes	-	-	1	3 int. + 1 ext.	196425		
	120 V AC	Cable gland	-	-	-	0	3 int. + 1 ext.	196470		
			-	-	-	1	3 int. + 1 ext.	196471		
			-	-	-	2	3 int. + 1 ext.	196472		
			-	-	-	3	3 int. + 1 ext.	196473		
			Yes	-	-	1	3 int. + 1 ext.	196475		
	AS-Interface (62 slaves)	29.5...31.6 V DC	Version with AS-i flat cable clip and 80 cm cable	-	-	-	0	3 int. + 1 ext.	196430	
-				-	-	1	3 int. + 1 ext.	196431		
-				-	-	2	3 int. + 1 ext.	196432		
-				-	-	3	3 int. + 1 ext.	196433		
Yes				-	-	1	3 int. + 1 ext.	196435		
		Version with 80 cm cable, without AS-i flat cable clip	-	-	-	0	3 int. + 1 ext.	20056039		
			-	-	-	1	3 int. + 1 ext.	384550		
			-	-	-	2	3 int. + 1 ext.	20029227		
			-	-	-	3	3 int. + 1 ext.	291622		
			-	-	-	3	3 int. + 1 ext.	291622		
IO-Link	18...30 V DC (according to specification)	Multipole M12, 5-pin (Port Class B) with 15 cm cable	-	-	-	0	3 int. + 1 ext.	359308		
			-	-	-	1	3 int. + 1 ext.	358577		
			-	-	-	2	3 int. + 1 ext.	359309		
			-	-	-	3	3 int. + 1 ext.	355009		
			Yes	-	-	0	3 int. + 1 ext.	359322		
			Yes	-	-	1	3 int. + 1 ext.	359323		
			Yes	-	-	2	3 int. + 1 ext.	359324		
			Yes	-	-	3	3 int. + 1 ext.	359325		
			Multipole, 4-pin (Port Class A) with 15 cm cable	-	-	-	0	3 int. + 1 ext.	359167	
				-	-	-	1	3 int. + 1 ext.	358578	
		-		-	-	2	3 int. + 1 ext.	359258		
		-		-	-	3	3 int. + 1 ext.	358579		
		Yes		-	-	0	3 int. + 1 ext.	359318		
					Yes	-	-	1	3 int. + 1 ext.	359319
					Yes	-	-	2	3 int. + 1 ext.	359320
Yes	-				-	3	3 int. + 1 ext.	359321		
Yes	-				-	3	3 int. + 1 ext.	359321		
bÜS / CANopen	Via bus	Cable gland	-	-	-	0	3 int. + 1 ext.	363169		
			-	-	-	1	3 int. + 1 ext.	363164		
			-	-	-	2	3 int. + 1 ext.	363166		
			-	-	-	3	3 int. + 1 ext.	363168		
		Multipole M12, 5-pin, 80 cm cable	-	-	-	1	3 int. + 1 ext.	363140		
			-	-	-	2	3 int. + 1 ext.	363160		
			-	-	-	3	3 int. + 1 ext.	363163		

DTS 1000140628 EN Version: N Status: RL (released | freigegeben | validé) printed: 11.12.2023

Communi- cation	Operating voltage	Connection	ATEX Zone 2/22 Cat. 3	FM NI Class I Division 2	cULus	Number of solenoid valves	Position feedback	Article no.
<b>FM/UL version</b>								
Analogue	12...28 V DC	Cable gland	-	Yes	-	0	3 int. + 1 ext.	267358 
			-	Yes	-	1	3 int. + 1 ext.	261483 
			-	Yes	-	3	3 int. + 1 ext.	261484 
			-	-	Yes	1	3 int. + 1 ext.	281497 
			-	-	Yes	3	3 int. + 1 ext.	281498 
AS-Interface (62 slaves)	29.5...31.6 V DC	Cable gland	-	Yes	-	1	3 int. + 1 ext.	261485 
			-	Yes	-	2	3 int. + 1 ext.	268730 
			-	Yes	-	3	3 int. + 1 ext.	261486 
			-	-	Yes	1	3 int. + 1 ext.	329396 
			-	-	Yes	3	3 int. + 1 ext.	329397 
IO-Link	18...30 V DC (according to specification)	Cable gland (Port Class B)	-	Yes	-	1	3 int. + 1 ext.	20003495 
			-	Yes	-	2	3 int. + 1 ext.	20003499 
			-	Yes	-	3	3 int. + 1 ext.	20003500 
		Multipole 5-pin (Port Class B) with 15 cm cable	-	-	Yes	0	3 int. + 1 ext.	359314 
			-	-	Yes	1	3 int. + 1 ext.	359315 
			-	-	Yes	2	3 int. + 1 ext.	359316 
			-	-	Yes	3	3 int. + 1 ext.	359317 
		Cable gland (Port Class A)	-	Yes	-	1	3 int. + 1 ext.	20002932 
			-	Yes	-	2	3 int. + 1 ext.	20003418 
			-	Yes	-	3	3 int. + 1 ext.	20003427 
		Multipole, 4-pin (Port Class A) with 15 cm cable	-	-	Yes	0	3 int. + 1 ext.	359310 
			-	-	Yes	1	3 int. + 1 ext.	359311 
			-	-	Yes	2	3 int. + 1 ext.	359312 
-	-		Yes	3	3 int. + 1 ext.	359313 		

#### Further versions on request



#### Additional















AS-Interface: connection M12, 4-pin 8 cm cable  
 AS-Interface (31 Slaves)

## 7.4. Ordering chart accessories

### Standard accessories

**Note:**



















Must be ordered separately.

Version	Article no.
Rotary push-in fitting, nickel-plated brass G ¼ for tube Ø 8/6	780084 
Rotary push-in fitting, nickel-plated brass G ⅜ for tube Ø 6/4	780082 
Universal adapter with O-ring	196495 
Target for position sensor, 1.4021	196494 
Magnetic manual override tool	196490 
AS-Interface flat cable clamp, M12 outlet, stainless steel outlet	799646 
USB interface for serial communication	227093 
USB bÜS interface set 1 (Type 8923) for connection to the Bürkert Communicator software: includes connection cable (M12 and micro USB), stick with integrated terminating resistor, power supply and software	772426 
Software Bürkert Communicator	<b>Type 8920</b> 
Silencer, G ¼	780780 
Blind plug PP, G ⅜	770901 
8 cm cable with M12 plug, 12-pin, for 24 V DC	217574 
80 cm cable with M12 plug, 4-pin, for AS-i	217572 
27 cm cable with M12 plug, 4-pin	217573 
Set with 20 lead seals to avoid tool-free opening of the cover	257100 

### Special accessories for Type 8681 bÜS/CANopen

**Note:**

Standard gateway (non-configured) see **data sheet Type ME43** 

Version	Article no.
Pre-configured SYME43 gateway <sup>1.)</sup> for integration of Type 8681 bÜS/CANopen in EtherNet/IP	316696 
CAN distributor with 8 x M12 sockets, stainless steel	338398 
Connection cable with M12 plug, 5-pin, cable length: 990 mm	218187 
Connection cable with M12 socket, stainless steel, cable length: 1 m	773482 
Connection cable with M12 socket, stainless steel, cable length: 3 m	773483 
Extension cable for M12 plug and M12 socket, stainless steel, cable length: 0.5 m	773484 
Extension cable for M12 plug and M12 socket, stainless steel, cable length: 1 m	773485 
Extension cable for M12 plug and M12 socket, stainless steel, cable length: 3 m	773486 
Extension cable for M12 plug and M12 socket, stainless steel, cable length: 5 m	773487 
Extension cable for M12 plug and M12 socket, stainless steel, cable length: 10 m	773488 
Extension cable for M12 plug and M12 socket, stainless steel, cable length: 20 m	773489 
CAN terminating resistor, M12 plug, stainless steel, 120 Ω	773490 
CAN terminating resistor, M12 socket, stainless steel, 120 Ω	773491 
M12 CAN Y connection piece, stainless steel (1x M12 plug, 2x M12 socket)	773492 
M12 CAN T connection piece, stainless steel (1x M12 plug, 2x M12 socket)	773493 
Fixing plate for M12-CAN-T connection piece, stainless steel	773494 
Screw plug for M12 socket	308778 
Set protection cover M12 with O-ring (spare part)	308785 
USB bÜS interface set 1 (Type 8923) for connection to the Bürkert Communicator software: includes connection cable (M12 and micro USB), stick with integrated terminating resistor, power supply and software	772426 

1.) Further system-specific configurations are available on request.