



Control head for decentralised automation of ELEMENT process valves

- Contact-free inductive valve position registration (Teach function)
- Colour illuminated status display
- Integrated pilot air duct in the actuator
- Fieldbus interface AS-Interface, IO-Link or Bürkert system bus (büS)
- With ATEX II cat. 3G/D / IECEx approval

Product variants described in the data sheet may differ from the product presentation and description.

Can be combined with

	Type 2100 ▶ Pneumatically operated 2/2-way angle seat valve ELEMENT for decentralized automation
	Type 2101 ▶ Pneumatically operated 2/2-way globe valve ELEMENT for decentralized automation
	Type 2103 ▶ 2/2-way diaphragm valve with pneumatic stainless steel actuator (Type ELEMENT) for decentralised automation
	Type 2104 ▶ T-diaphragm valve with pneumatic actuator in stainless steel (Type ELEMENT) for decentralised automation
	Type 2105 ▶ Tank bottom diaphragm valve with pneumatic actuator in stainless steel (Type ELEMENT) for decentralised automation
	Type 2106 ▶ Pneumatically operated 3/2-way seat valve ELEMENT for decentralized automation

Type description

The device Type 8691 control head is designed for decentralised automation of ELEMENT Type 21xx pneumatic process valves. The valve position is registered via a contact-free, analogue sensor element which automatically detects and saves the valve end position using the Teach function during start-up. The integrated pilot valve controls single or double-acting actuators. An optional communication interface, AS-Interface, IO-Link or büS (based on CANopen) can be selected.

The design of the control head and the actuator permits internal control air routing without external piping. Besides the electrical position feedback, the device status is shown directly on the control head itself through coloured powerful LEDs, even in difficult ambient conditions.

The housing is easy to clean and features proven IP protection and chemically resistant materials for use in hygienic processing in the food, beverage and pharmaceutical industries. Focused on plant wash-down applications, the IP protection of the housing is supported by positive pressure inside the control head. Combined with Bürkert ELEMENT actuators, the pneumatic actuating system enables spring chamber aeration that avoids actuator chamber contamination from the environment.

Table of contents

1. General technical data	3
1.1. Control head Type 8691	3
1.2. Without fieldbus communication: 24 V DC	4
1.3. With fieldbus communication: AS-Interface	5
1.4. With digital communication: IO-Link	5
1.5. With digital communication: Bürkert system bus (bÜS)	5
1.6. Functional overview Type 8691	6
2. Approvals and conformities	7
2.1. General notes	7
2.2. Conformity	7
2.3. Standards	7
2.4. Explosion protection	7
2.5. North America (USA/Canada)	7
2.6. Others	7
China Compulsory Certification (CCC)	7
3. Materials	8
3.1. Material specifications	8
4. Dimensions	8
4.1. Mounting on process valve ELEMENT Type 21xx	8
5. Device/Process connections	9
5.1. Electrical connections	9
Without fieldbus communication 24 V DC	9
AS-Interface connection	10
IO-Link connection	10
Bürkert system bus (bÜS) connection	10
6. Product installation	11
6.1. Combination options with pneumatic process valves	11
7. Ordering information	12
7.1. Bürkert eShop	12
7.2. Bürkert product filter	12
7.3. Ordering chart	13
7.4. Ordering chart accessories	14
Standard accessories	14
Adapter kits	14

1. General technical data

1.1. Control head Type 8691

Product properties	
Dimensions	Further information can be found in chapter "4. Dimensions" on page 8.
Material	
Body	PPS, stainless steel
Seal	EPDM
Cover	PC
Operation	
Operating keys	2
Service interface	Connected to PC via USB connection
Configuration tool	Bürkert Communicator
Commissioning	
Setting valve end position	Through automatic or manual teach function
Manual operation of pilot valve	Yes
Status display	
Display of device and valve status	High-power LEDs (colours individually adjustable)
Communication	
Fieldbus	AS-Interface, IO-Link
Digital	Bürkert system bus (bÜS) (based on CANopen)
Performance data	
Functional overview	Further information can be found in chapter "1.6. Functional overview Type 8691" on page 6.
Position sensor	
Analogue position sensor	Inductive (contactless) with self-adjusting switching points (PNP) (NPN on request)
Stroke range for linear actuator	
Valve spindle	2.5...45 mm
Electrical data	
Electrical connection	
Multipole version	M12, 8-pin resp. 4- or 5-pin according to device version (see "5. Device/Process connections" on page 9)
Cable gland version	M16 x 1.5 (terminal range 5...10 mm) With screw terminals for cable cross sections 0.14...1.5 mm ²
Pneumatic data	
Control medium	
Dust content	Neutral gases, air, quality class according to ISO 8573-1 Class 7 (< 40 µm particle size)
Particle density	Class 5 (< 10 mg/m ³)
Pressure dew point	Class 3 (< -20 °C)
Oil content	Class X (< 25 mg/m ³)
Air supply filter	
Mesh size	Exchangeable ~0.1 mm
Supply pressure	3...7 bar ¹⁾
Pilot air port	Threaded connection G 1/8, stainless steel
Positioning system	
Circuit function	Single and double-acting
Air capacity	250 l _N /min (for aeration and ventilation) (Q _{Nn} value according to definition at pressure drop from 7 to 6 bar abs)
Actuator series/size	Type 21xx, actuator Ø 70/90/130 mm

Approvals and conformities

Explosion protection

Ignition protection class	II 3D Ex tc IIIC T135 °C Dc II 3G Ex ec IIC T4 Gc
ATEX	BVS 14 ATEX E 008 X II 3D Ex tc IIIC T135 °C Dc II 3G Ex ec IIC T4 Gc
IECEX	IECEX BVS 14.0009 X Ex tc IIIC T135 °C Dc Ex ec IIC T4 Gc

Further information can be found in chapter [“2.4. Explosion protection” on page 7.](#)

North America (USA/Canada)

UL Listed for the USA and Canada	cULus certificate: E238179 Further information can be found in chapter “2.5. North America (USA/Canada)” on page 7.
FM Explosion Protection	Increased Safety for Class I, Zone 2, AEx ec IIC T4 Gc hazardous (classified) locations, indoors and outdoors (IP54). Alternatively marked as Class I Division 2 Groups A, B, C, and D; T4. Further information can be found in chapter “2.5. North America (USA/Canada)” on page 7.

Others

China Compulsory Certification (CCC)	The products with Ex approval are suitable for import and use for hazardous applications in China. Further information can be found in chapter “2.6. Others” on page 7.
--------------------------------------	---

Further information can be found in chapter [“2. Approvals and conformities” on page 7.](#)

Environment and installation

Operating conditions

Ambient temperature

With pilot valve	-10...+55 °C
Without pilot valve	-20...+60 °C
Degree of protection	IP65/IP67 according to EN 60529, 4X according to NEMA 250 Standard
Operating altitude	Up to 2000 m above sea level

Installation and mechanical data

Mounting variants	Direct mounting
Installation position	As required, preferably with actuator in upright position
Valve actuator (type, size)	ELEMENT Type 21xx (actuator Ø 70/90/130 mm)
Adapter kit	Further information can be found in chapter “Adapter kits” on page 14.

1.) The supply pressure applied must be 0.5 to 1 bar above the minimum required pilot pressure of the valve actuator.

1.2. Without fieldbus communication: 24 V DC

Electrical data

Operating voltage	24 V DC ±25 % UL: NEC Class 2
Residual ripple	10 %
Power consumption	2 W or 5 W at maximum load on an active digital output
Protection class	III according to DIN EN 61140

Electrical connection

Multipole version	M12, 8-pin
Cable gland version	M16 x 1.5 (cable Ø 5...10 mm) with terminals for cable cross-sections 0.14...1.5 mm ²

Input/Output

Output	Max. 100 mA per output
--------	------------------------

1.3. With fieldbus communication: AS-Interface

Product properties	
Profile	S-B.A.E (AB slave, max. 62 slaves/master), certificate no. 136701 according to specification v3.0
Electrical data	
Operating voltage	Via ASi power supply 29.5...31.6 V DC (according to specification), UL: NEC Class 2
Protection class	III according to DIN EN 61140
Power consumption	
Max. current consumption	110 mA
Unit with additional actuator supply (AUX Power)	External power supply 24 V DC \pm 10 % (the power supply unit must contain one secured disconnection according to IEC 364-4-41 (PELV or SELV))
System supply	Max. 110 mA without additional actuator supply (AUX Power), with pilot valve. Max. 60 mA with additional actuator supply or without pilot valve
Actuator supply	Max. 50 mA with additional actuator supply
Electrical connection	M12, 4-pin
Output	
Contact rating pilot valve	Approx. 0.8 W
Watchdog function	Integrated

1.4. With digital communication: IO-Link

Electrical data	
Electrical connection	M12 x 1, 5-pin, A-coded
IO-Link revision	1.1
SIO-Mode	Nein
VendorID	0x0078, 120
DeviceID	See IODD file (the IODD file can be downloaded from our website Type 8691 ▶, see Software > Device Description Files)
Transmission rate	230.4 kbit/s
Data storage	Yes
Maximum cable length	20 m
Port class	A and B
Power supply	Via IO-Link
Port Class A	
Operating voltage	24 V DC \pm 25 % (according to specification)
System supply	Max. 150 mA with pilot valve Max. 100 mA without pilot valve
Port Class B	
Operating voltage	
System supply (Pin 1 + 3)	24 V DC \pm 25 % (according to specification)
Actuator supply (Pin 2 + 5)	24 V DC \pm 25 % (according to specification)
Current consumption	
System supply (Pin 1 + 3)	Max. 100 mA
Actuator supply (Pin 2 + 5)	Max. 50 mA

1.5. With digital communication: Bürkert system bus (būS)

Electrical data	
Operating voltage	18...30 V DC (according to specification)
Electrical connection	M12 x 1, 5-pin, A-coded
Current consumption	Max. 120 mA

1.6. Functional overview Type 8691

Function	Version				
	24 V	IO-Link	AS-Interface Standard-Slave	AS-Interface A/B-Slave	büS/CANopen
Basic functions					
Teach function position sensor	X	X	X	X	X
Manual override of pilot valve (mechanical)	X	X	X	X	X
Manual override of pilot valve (electrical)	-	X	-	-	X
Position feedback process valve	X	X	X	X	X
Feedback signal current valve position (intermediate position)	-	X	-	-	-
Optical position feedback/status display high-performance LEDs	X	X	X	X	X
Colour change of the optical position feedback possible (LED in 3 colours: green, yellow, red)	X	X	X	X	X
Selection of LED display modes	-	X	-	-	X
Diagnostic LEDs	-	X	X	X	X
Selection of different LED display modes	-	X	-	-	X
Date storage function	-	X	-	-	-
Locating function	-	X	-	-	X
büS communication interface (Bürkert system bus)	-	-	-	-	X
büS service interface (for Bürkert Communicator software)	-	X	-	-	X
Diagnosis					
Process valve switching cycles counter with definable limit value	-	X	-	-	X
Pilot valve switching cycles counter	-	X	-	-	X
Operating hours counter with definable limit value	-	X	-	-	X
Process valve counter for opening/closing timeout	-	X	-	-	X
Travel accumulator with definable limit value	-	X	-	-	X
Active diagnostic messages (feedback when limit values are exceeded)	-	X	-	-	X
Diagnosis reset command (to reset counter values)	-	X	-	-	X
Error feedback displacement transducer	-	X	X	X	X
Self-monitoring control head with automatic error message	-	X	-	-	X
Feedback Teach error	X	X	X	X	X
Feedback overtemperature	-	X	-	-	X
Feedback communication error	-	X	X	X	X
Feedback for opening/closing timeout	-	X	-	-	X
Tolerance for switching time overrun	-	X	-	-	X
Error detection if the setpoint position is not reached (end positions not reached)	-	X	-	-	X
Tolerance band of end position detection	-	X	-	-	-
Detection of under-voltage and over-voltage of power supply	-	X	-	-	X
Log function for error cases	-	X	-	-	X
Parameterization					
Enable/disable safety position in case of setpoint or bus error	-	X	-	-	X
Selecting and setting the SIO mode	-	X	-	-	-
Selection of digital outputs (end positions) PNP, NPN	X	X	-	-	-
Selection of digital outputs (end positions) PNP, NPN, PP	-	X	-	-	-
Deactivation of local operation (lock function)	-	X	-	-	X
Factory reset function (reset to factory setting)	-	X	-	-	X

DTS 1000110599 EN Version: AC Status: RL (released | freigegeben | valide) printed: 13.11.2023

2. Approvals and conformities

2.1. General notes

- The approvals and conformities listed below must be stated when making enquiries. This is the only way to ensure that the product complies with all required specifications.
- Not all available versions can be supplied with the below mentioned approvals or conformities.



2.2. Conformity

In accordance with the Declaration of Conformity, the product is compliant with the EU Directives.



2.3. Standards

The applied standards which are used to demonstrate compliance with the EU Directives are listed in the EU-Type Examination Certificate and/or the EU Declaration of Conformity.

2.4. Explosion protection

Approval	Description
 	<p>Optional: Explosion protection</p> <p>ATEX: BVS 14 ATEX E 008 X II 3D Ex tc IIIC T135 °C Dc II 3G Ex ec IIC T4 Gc</p> <p>IECEx: IECEx BVS 14.0009 X Ex tc IIIC T135 °C Dc Ex ec IIC T4 Gc</p>

2.5. North America (USA/Canada)

Approval	Description
	<p>Optional: UL Listed for the USA and Canada The products are UL Listed for the USA and Canada according to:</p> <ul style="list-style-type: none"> • UL 61010-1 (ELECTRICAL EQUIPMENT FOR MEASUREMENT, CONTROL, AND LABORATORY USE – Part 1: General Requirements) • CAN/CSA-C22.2 No. 61010-1
	<p>Optional: FM (Factory Mutual) – Explosion Protection Increased Safety for Class I, Zone 2, AEx ec IIC T4 Gc hazardous (classified) locations, indoors and outdoors (IP54). Alternatively marked as Class I Division 2 Groups A, B, C, and D; T4.</p>

2.6. Others

China Compulsory Certification (CCC)

Conformity	Description
	<p>Optional: China Compulsory Certification (CCC) The products with Ex approval are suitable for import and use for hazardous applications in China.</p>

DTS 1000110599 EN Version: AC Status: RL (released | freigegeben | valide) printed: 13.11.2023

3. Materials

3.1. Material specifications

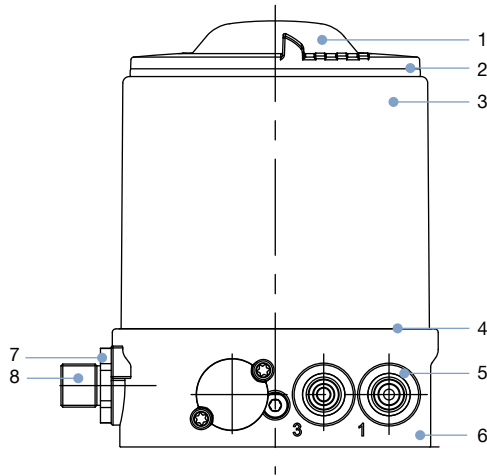

No.	Element	Material
1	Cover	PC
2	Seal	EPDM
3	Body casing	Stainless steel
4	Seal	EPDM
5	Push-in connector Threaded ports G 1/8	POM/stainless steel Stainless steel
6	Basic housing	PPS
7	Screws	Stainless steel
8	M12 plug connector M12	Stainless steel

4. Dimensions

4.1. Mounting on process valve ELEMENT Type 21xx

Note:

Dimensions in mm

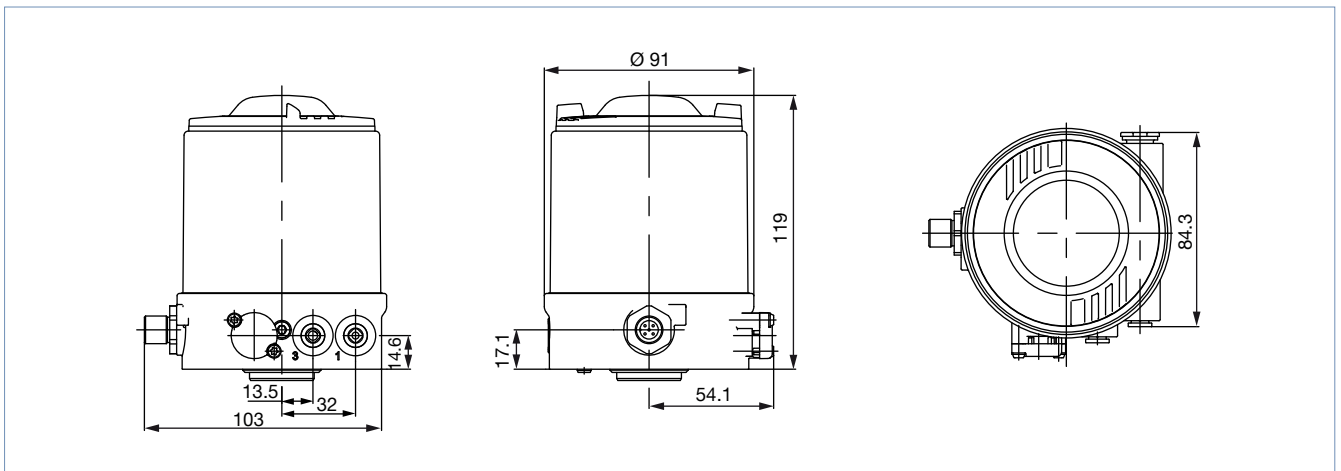

DTS 1000110599 EN Version: AC Status: RL (released | freigegeben | validé) printed: 13.11.2023

5. Device/Process connections

5.1. Electrical connections

Without fieldbus communication 24 V DC

M12 circular plug, 8-pin

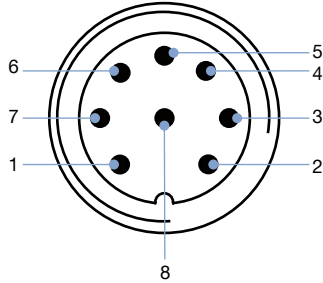

Pin	Description	Pin assignment
1	Limit switches 1	I _N 1/TOP
2	Limit switches 2	I _N 2/BOTTOM
3	Operating voltage	GND
4	Operating voltage +	24 V DC
5	Valve control +	Valve +
6	Valve control -	Valve -
7	-	Not assigned
8	-	Not assigned

Cable gland

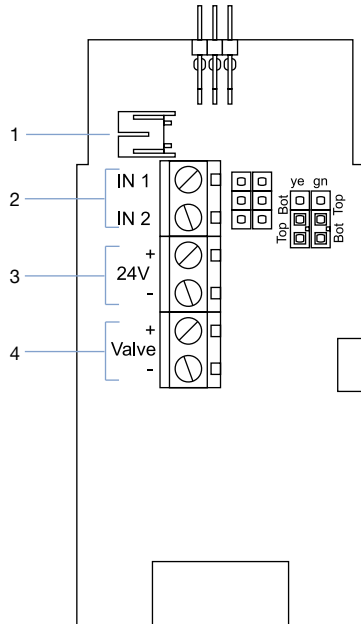

Input signal

Pin	Pin assignment
1	Valve connection
2	Connecting terminals End positions
3	Connecting terminals Supply 24 V DC
4	Connecting terminals Valve (input signal)

AS-Interface connection

M12 circular plug, 4-pin, without external power supply			
Pin	Description	Pin assignment	
1	Bus +	Bus cable AS-Interface +	
2	NC	Not assigned	
3	Bus -	Bus cable AS-Interface -	
4	NC	Not assigned	
5	NC	Not assigned	

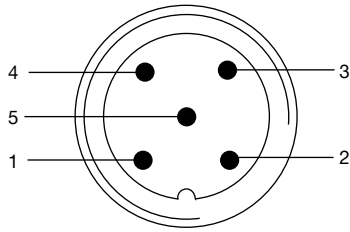

M12 circular plug, 4-pin, with external power supply (on request)			
Pin	Description	Pin assignment	
1	Bus +	Bus cable AS-Interface +	
2	GND (optional)	External power supply	
3	Bus -	Bus cable AS-Interface -	
4	24 V + (optional)	External power supply	
5	NC	Not assigned	

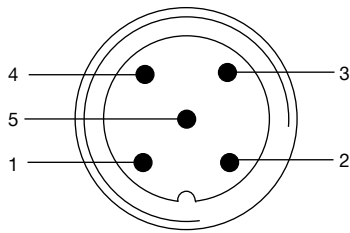

IO-Link connection

M12 circular plug, 5-pin, Port Class A			
Pin	Description	Pin assignment	
1	L +	24 V DC	System supply
2	I/Q	NC	Not connected
3	L -	0 V (GND)	System supply
4	C/Q	IO-Link	Communication
5	NC	NC	Not connected

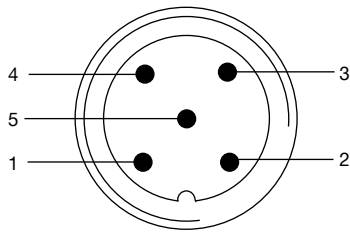

M12 circular plug, 5-pin, Port Class B			
Pin	Description	Pin assignment	
1	L +	24 V DC	System supply
2	P24	24 V DC	Actuator supply
3	L -	0 V (GND)	System supply
4	C/Q	IO-Link	Communication
5	N24	0 V (GND)	Actuator supply

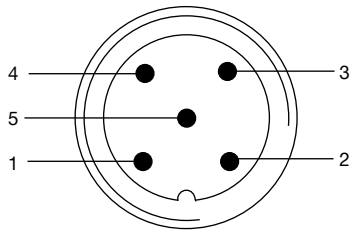

Bürkert system bus (bùS) connection

M12 circular plug, 5-pin			
Pin	Description	Cable colour	
Supply voltage: 18...30 V DC (bùS)			
2	V +	Red	
3	V -	Black	
Data lines			
1	Drain/Shielding	-	
4	CAN_H	White	
5	CAN_L	Blue	

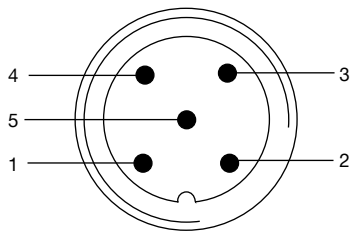

DTS 1000110599 EN Version: AC Status: RL (released | freigegeben | validé) printed: 13.11.2023

6. Product installation

6.1. Combination options with pneumatic process valves

Note:

A complete **TopControl control valve system Type 8691** and an **ELEMENT process valve Type 21xx**.

The following information is required to select a complete system:

- **Article no.** of the desired **control head**, see **data sheet Type 8691**
- **Article no.** of the desired **process valve Type 21xx**, see **data sheet Type 2100 ▶, Type 2101 ▶ and Type 2103 ▶**

You order two components and receive a completely assembled and tested valve.

Example of decentralised automation of On/Off ELEMENT valve systems



1.) See data sheet **adaptations for third-party actuators Type KK01 ▶** or contact the relevant Bürkert sales office.

7. Ordering information

7.1. Bürkert eShop



Bürkert eShop – Easy ordering and quick delivery

You want to find your desired Bürkert product or spare part quickly and order directly? Our online shop is available for you 24/7. Sign up and enjoy all the benefits.

[Order online now](#)

7.2. Bürkert product filter



Bürkert product filter – Get quickly to the right product

You want to select products comfortably based on your technical requirements? Use the Bürkert product filter and find suitable articles for your application quickly and easily.

[Try out our product filter](#)

7.3. Ordering chart

Note:

All standard versions are UL-approved (UL approval for IO-Link).

Communication	Electrical connection	Circuit function Pilot valve system	Pilot air port (threaded port)	Article no.	
				Standard	ATEX II Cat. 3G/D, IECEx, CCC ^{1.)}
AS-Interface Slave profile: S-B.A.E (AB-Slave, max. 62 slaves)	M12 circular plug connector	Single-acting	G 1/8	227254	264988
		Double-acting	G 1/8	227240	264975
	M12 circular plug connector/ Flat cable clip/80 cm cable	Single-acting	G 1/8	227258	264990
		Double-acting	G 1/8	227244	264977
IO-Link	M12 circular plug connector	Single-acting	G 1/8	307371	321927
		Double-acting	G 1/8	307368	321925
Bürkert system bus (büS)	M12 circular plug connector	Single-acting	G 1/8	307375	321931
		Double-acting	G 1/8	307373	321929
		Without	G 1/8	307379	321935
Without fieldbus communication	M12 circular plug connector	Single-acting	G 1/8	227262	264992
		Double-acting	G 1/8	227248	264979
		Without	G 1/8	246211	264972
	Cable gland	Single-acting	G 1/8	227260	264991
		Double-acting	G 1/8	227246	264978
		Without	G 1/8	264943	264971

1.) CCC (China Compulsory Certificate) for device versions with Ex approval

Further versions on request













Additional
büS/CANopen

7.4. Ordering chart accessories

Standard accessories

Note:

Must be ordered separately.

Description	Article no.
M12 circular socket with cable, 8-pin, cable length: 5 m, for input and output signals	919267 
AS-interface flat cable clamp, M12 outlet, stainless steel outlet	799646 
USB büS interface set 2 (Type 8923) for connection to the Bürkert Communicator software: including büS stick, connection cable to M12 plug, M12 connection cable on micro USB for the büS service interface and Y distributor, cable length: 0.7 m	772551 
büS cable extension, M12, cable length: 1 m	772404 
büS cable extension, M12, cable length: 3 m	772405 
büS cable extension, M12, cable length: 5 m	772406 
büS cable extension, M12, cable length: 10 m	772407 
Silencer G 1/8	780779 
Sensor Puck (spare part)	682240 
Software Bürkert Communicator	Type 8920 

Adapter kits

Note:

Must be ordered separately.

Adapter kits for third-party actuators can be found in the **data sheet Adaptation for third-party actuators Type KK01**  or contact the appropriate Bürkert sales office.

Description	Actuator size	Control function	Article no.
Attachment kit for Type 21xx/23xx actuator series	Ø 70/90/130 mm	Universal	679917 