

# Type 3360, 3361, AE3360, AE3361, AE33

Electromotive control valve



## Operating instructions

We reserve the right to make technical changes without notice.  
Technische Änderungen vorbehalten.  
Sous réserve de modifications techniques.

© Bürkert Werke GmbH & Co. KG, 2016–2023

Operating Instructions 2301/06\_ENen\_00810490 / Original DE

## Electromotive control valve

### INHALT

<b>1</b>	<b>OPERATING INSTRUCTIONS</b> .....	<b>8</b>
1.1	Symbols.....	8
1.2	Definition of terms.....	9
<b>2</b>	<b>INTENDED USE</b> .....	<b>10</b>
<b>3</b>	<b>BASIC SAFETY INSTRUCTIONS</b> .....	<b>11</b>
<b>4</b>	<b>GENERAL NOTES</b> .....	<b>13</b>
4.1	Contact address.....	13
4.2	Warranty.....	13
4.3	Information on the Internet.....	13
<b>5</b>	<b>PRODUCT DESCRIPTION</b> .....	<b>14</b>
5.1	General description.....	14
5.2	Properties.....	14
5.3	Variants.....	15
<b>6</b>	<b>STRUCTURE AND FUNCTION</b> .....	<b>18</b>
6.1	Representation – Structure of the electromotive control valve AG2.....	19
6.2	Representation – Structure of the electromotive control valve AG3.....	20
6.3	Valve position after supply voltage failure.....	20
6.4	Safety position.....	21
6.5	Display of the device status.....	22
6.6	Factory settings.....	24
<b>7</b>	<b>CONTROL ELECTRONICS</b> .....	<b>25</b>
7.1	Functional diagram of the electromotive control valve.....	27
7.2	Functionality of the control electronics.....	28
7.3	Energy storage SAFEPOS energy-pack (option).....	31
<b>8</b>	<b>TECHNICAL DATA</b> .....	<b>35</b>
8.1	Standards and directives.....	35

8.2	Approvals .....	35
8.3	Type label .....	35
8.4	Operating conditions .....	36
8.5	General technical data .....	39
8.6	Electrical data .....	40
8.7	Flow rate values and flow rate characteristics for angle seat control valve (Type 3360).....	43
8.8	Flow rate values and flow rate characteristics for globe control valve (Type 3361).....	47
<b>9</b>	<b>INSTALLING THE VALVE.....</b>	<b>50</b>
9.1	Safety instructions .....	50
9.2	Installation of devices with threaded connection, flange connection or clamp connection .....	50
9.3	Installation of devices with welded connections.....	52
9.4	Disassembly of the actuator from the valve body .....	54
9.5	Installing actuator on valve body.....	56
9.6	Rotating the actuator .....	58
9.7	Holding device.....	59
<b>10</b>	<b>ELECTRICAL INSTALLATION.....</b>	<b>60</b>
10.1	Electrical installation with circular plug-in connector.....	60
10.2	Electrical connection fieldbus gateway .....	65
10.3	Electrical installation with cable gland (only AG2) .....	66
<b>11</b>	<b>START-UP .....</b>	<b>73</b>
11.1	Safety instructions .....	73
11.2	Before start-up.....	73
11.3	Configuration options for start-up.....	73
11.4	Base settings .....	73
11.5	Set safety position .....	75
11.6	Adjustment of position controller – execute X.TUNE.....	76
11.7	Set standard signal for set-point position.....	78
11.8	Select physical unit for process control.....	79
11.9	Configure process values .....	80
11.10	Scaling the process control .....	81

11.11	Set dead band for process control .....	82
11.12	Setting up process control and executing P.LIN, P.TUNE.....	83
11.13	Set AUTOMATIC operating state.....	85
<b>12</b>	<b>OPERATION.....</b>	<b>86</b>
12.1	Overview: availability of the operating elements.....	86
12.2	Display elements .....	87
12.3	Operating elements.....	89
12.4	büS service interface.....	90
12.5	SIM card – acquire and save data (option) .....	91
<b>13</b>	<b>DISPLAY OPERATION (OPTION).....</b>	<b>92</b>
13.1	User interface .....	92
13.2	Description of buttons.....	92
13.3	Display views.....	93
13.4	Description of symbols.....	97
13.5	Access rights and password protection.....	99
13.6	Screen saver.....	101
<b>14</b>	<b>BASIC FUNCTIONS.....</b>	<b>102</b>
14.1	Changing the operating state, AUTOMATIC, MANUAL .....	102
14.2	Enable – disable sealing function.....	105
14.3	Enabling – disabling correction characteristic .....	107
14.4	Change effective direction.....	110
14.5	Disabling process control .....	112
<b>15</b>	<b>MANUAL OVERRIDE OF VALVE.....</b>	<b>113</b>
15.1	Electrical override of valve on devices without a display module .....	113
15.2	Electrical override of valve on devices with a display module.....	115
15.3	Electrically actuating the valve using the Bürkert Communicator or display .....	116
15.4	Actuating the valve mechanically.....	117
<b>16</b>	<b>ADVANCED FUNCTIONS.....</b>	<b>124</b>
<b>17</b>	<b>OPERATING STRUCTURE AND FACTORY SETTING .....</b>	<b>125</b>

17.1	Operating structure of the configuration area .....	125
17.2	Context menu for operation on display .....	143
<b>18</b>	<b>INDUSTRIAL ETHERNET .....</b>	<b>145</b>
18.1	Fieldbus gateway description .....	145
18.2	Technical data Industrial Ethernet.....	147
18.3	Projecting via fieldbus.....	148
18.4	Web server.....	150
<b>19</b>	<b>CANopen.....</b>	<b>153</b>
19.1	Projecting via fieldbus.....	153
19.2	CANopen network configuration.....	153
<b>20</b>	<b>büS.....</b>	<b>154</b>
20.1	Cabling of büS networks.....	154
20.2	Configuration of büS networks.....	154
<b>21</b>	<b>MAINTENANCE.....</b>	<b>155</b>
21.1	Safety instructions .....	155
21.2	Actuator.....	155
21.3	Wearing parts of the valve .....	155
21.4	Visual inspection .....	156
21.5	Maintenance notifications .....	156
<b>22</b>	<b>TROUBLESHOOTING AND MESSAGES.....</b>	<b>157</b>
22.1	Error notifications .....	157
22.2	Notifications on device status “Out of specification”.....	159
22.3	Notifications on device status “Function check”.....	160
<b>23</b>	<b>CLEANING.....</b>	<b>160</b>
<b>24</b>	<b>ACCESSORIES, WEARING PARTS.....</b>	<b>161</b>
24.1	Communication software .....	162
<b>25</b>	<b>DISASSEMBLY.....</b>	<b>162</b>
25.1	Safety instructions .....	162

26	PACKAGING AND TRANSPORT .....	163
27	STORAGE.....	163
28	DISPOSAL .....	163

# 1 OPERATING INSTRUCTIONS

The operating instructions describe the entire life cycle of the device. Keep these instructions in an easily accessible location for every user. The instructions must be available to each new owner of the device.

## Important safety information!

Carefully read through the operating instructions. Study in particular the chapters entitled *Basic safety instructions* and *Intended use*.

- ▶ The operating instructions must be read and understood.

## 1.1 Symbols



### DANGER!

Warns of an immediate danger!

- ▶ Failure to observe these instructions will result in death or serious injuries.



### WARNING!

Warns of a potentially hazardous situation!

- ▶ Failure to observe these instructions may result in serious injuries or death.



### CAUTION!

Warns of a potential danger!

- ▶ Failure to observe these instructions may result in moderate or minor injuries.

### NOTE!

Warns of damage!

- Failure to observe the warning may result in damage to the device or the equipment.



Indicates important additional information, tips and recommendations.



Refers to information in these operating instructions or in other documentation.

- ▶ Designates instructions to avoid a danger.

→ Designates a procedure which you must carry out.



Designates a result.



Symbol for software interface texts.



## 1.2 Definition of terms

- **Device:** The term “Device” used in these instructions applies to the types described in these instructions:  
Type 3360, electromotive angle seat control valve  
Type 3361, electromotive globe control valve
- **AG2:** Actuator size 2 with a nominal force of 1300 or 2500 N for seat size 3–50  
**AG3:** Actuator size 3 with a nominal force of 7700 or 10000 N for seat size 40–100
- **Ex:** The abbreviation “Ex” used in these instructions stands for “potentially explosive”.
- The term “bÜS” (Bürkert system buS) used in this manual stands for the communication buS developed by Bürkert, based on the CANopen protocol.
- In these instructions, the unit bar stands for relative pressure. The absolute pressure is stated separately in bar(abs).

## 2 INTENDED USE

Improper use of the electromotive Type 3360 and 3361 control valve may be dangerous for people, nearby equipment and the environment.

The electromotive control valve is designed to control the flow of liquid and gaseous media.

- ▶ Standard devices must not be used in the potentially explosive area. They do not possess the separate “Ex” type label denoting the approval for use in potentially explosive environments.
- ▶ The use of alkaline cleaning agents is not permitted for cleaning the surface of the device.
- ▶ If the position of the valve has a bearing on safety concerns in the event of a power failure: Only use devices that have the SAFEPOS energy-pack (optional energy storage).
- ▶ When using the device, observe the authorised data, operating conditions and deployment conditions specified in the contract documents and in the operating instructions.
- ▶ Protect device from harmful environmental influences! (e.g. radiation, air humidity, fumes, etc.) For any matters requiring clarification, contact the relevant sales department.

### Use of the device

- ▶ Use only in conjunction with third-party devices and components recommended or approved by Bürkert.
- ▶ Only use when in perfect condition and always ensure proper storage, transportation, installation and operation.
- ▶ Use only as intended.

### 3 BASIC SAFETY INSTRUCTIONS

These safety instructions do not take into account any unforeseen circumstances and events which occur during installation, operation and maintenance. The operator is responsible for observing the location-specific safety regulations, also with reference to personnel.



#### Risk of injury from high pressure.

- ▶ Before working on the system or device, switch off the pressure and vent or empty the lines.

#### Danger of burns and risk of fire.

Following an extended duty cycle or as a result of a hot medium, the surface of the device may become hot.

- ▶ Only touch the device when wearing protective gloves.
- ▶ Keep the device away from highly flammable substances and media.

#### Danger due to loud noises.

- ▶ Depending on the operating conditions, the device may generate loud noises. More detailed information on the likelihood of loud noises is available from the relevant sales office.
- ▶ Wear hearing protection when in the vicinity of the device.

#### Discharge of medium if packing gland worn.

- ▶ Relief bore must be regularly inspected for any medium leakages.
- ▶ If medium is leaking from the relief bore, the packing gland must be replaced (see chapter “Maintenance”).
- ▶ If the medium is hazardous, secure the area around the leakage to prevent risks.

#### Risk of crushing by mechanically powered parts.

- ▶ Installation work on the control cone, diaphragm and valve body must only be performed while electrically isolated.  
For devices with SAFEPOS energy-pack: completely remove the SAFEPOS energy-pack. Wait until the LED ring is no longer lit and ensure that the LED status is not in “LED off” mode.
- ▶ Do not reach into the openings of the valve body.

#### Risk of uncontrolled process in the event of a power failure.

For devices without the optional SAFEPOS energy-pack, the valve will not stop in a defined position in the event of a power failure.

- ▶ If the position of the valve has a bearing on safety concerns in the event of a power failure: Only use devices that have the SAFEPOS energy-pack (optional energy storage).
- ▶ Select a valve position that is safe in respect of the process in the SAFEPOS menu.

### General hazardous situations.

To prevent injury, ensure that:

- ▶ In potentially explosive environments the device must only be used in accordance with the specifications on the separate type label.
- ▶ The additional information and safety instructions relating to potentially explosive atmospheres enclosed with the device or the separate operating instructions relating to potentially explosive atmospheres must be heeded when using the device.
- ▶ In potentially explosive atmospheres, only use devices with a separate “Ex” type label for use in such atmospheres.
- ▶ Feed only those media listed in chapter “[8 Technical data](#)” into the medium ports.
- ▶ Do not make any internal or external changes to the device and do not subject it to mechanical stress.
- ▶ Transport, install and dismantle a heavy device only with the aid of a second person and using suitable equipment.
- ▶ Secure the device against unintentional activation.
- ▶ Only trained technicians carry out installation and maintenance work.
- ▶ Following an interruption in the power supply, ensure that the process is restarted in a controlled manner. Observe the sequence.
  1. Connect supply voltage.
  2. Charge the device with medium.
- ▶ Observe general engineering standards & rules.
- ▶ The valves must be installed according to the regulations applicable in the country of use.

### NOTE!

#### Electrostatically sensitive components and assemblies.

The device contains electronic components that are susceptible to the effects of electrostatic discharging (ESD). Components that come into contact with electrostatically charged persons or objects are at risk. In the worst-case scenario, they will be destroyed immediately or will fail after start-up.

- Observe the requirements for minimizing or avoiding the possibility of damage caused by sudden electrostatic discharge in accordance with EN 61340-5-1.
- Do not touch electronic components when the supply voltage is connected.

## 4 GENERAL NOTES

### 4.1 Contact address

#### Germany

Bürkert Fluid Control Systems  
Sales Center  
Christian-Bürkert-Str. 13-17  
D-74653 Ingelfingen  
Tel. + 49 (0) 7940 - 10-91 111  
Fax + 49 (0) 7940 - 10-91 448  
E-mail: [info@burkert.com](mailto:info@burkert.com)

#### International

The contact addresses can be found on the back pages of the printed operating instructions.

Also on the Internet at:

[country.burkert.com](http://country.burkert.com)

### 4.2 Warranty

A precondition for the warranty is that the device is used as intended and that the specified usage conditions are taken into account.

### 4.3 Information on the Internet

Operating instructions and data sheets for Types 3360 and 3361 can be found on the Internet at:

[country.burkert.com](http://country.burkert.com)

## 5 PRODUCT DESCRIPTION

### 5.1 General description

The electromotive control valve Type 3360 and 3361 is suitable for controlling the flow of liquid and gaseous media. This may be neutral gas, water, alcohol, oil, fuel, hydraulic fluid, salt solution, caustic soda, organic solvent or vapour.

The control valve has an electromotive linear actuator with actuation electronics assembly. The actuation electronics assembly for position control or process control is actuated either via standard signals (analogue) or a fieldbus (digital). The electromotive linear actuator is set up such that it is optimally effective. At the same time, when idling without power, it also keeps the valve sealed and in position even under the maximum specified operating pressure.

The device can also be equipped with the energy storage system (SAFEPOS energy-pack). In the event of a supply voltage failure, the energy storage system supplies the actuator with the energy required to move the valve to the position defined in the SAFEPOS menu.

The valve position can be manually changed in two ways.

1. Electrical manual override: used if supply voltage is present.
2. Mechanical manual override: Must only be used if there is no supply voltage present.

The device can be set and operated either with 2 buttons and 4 DIP switches, or on a display with buttons for touch operation. It is also always possible to set the device with the bÜS service interface and by using the software Bürkert Communicator. The USB bÜS interface set, available as an accessory, is required for configuration with Bürkert Communicator.

One special characteristic of the Type 3361 globe control valve is the screwed-in valve seat, which can be replaced to reduce the seat size.

### 5.2 Properties

- High seal tightness due to self-adjusting packing gland.
- Devices with PTFE seal material are kept sealed without power.
- High flow rate values due to the stainless steel valve body that aids in flow.
- External, directly accessible display with buttons for touch operation.
- Mechanical position indicator shows the valve position even in the event of a supply voltage failure.
- 360° LED light ring for displaying device states, valve end positions and operating state.
- No electrical energy is required to hold the valve position even under maximum operating pressure, except for basic consumption for the control unit.
- Easy and quick replacement of the control cone.
- Valve actuator can rotate 360°.
- Integrated control unit for position control or process control.
- Contact-free, high-resolution and wear-free position sensor.
- The actuator housing consists of a robust and heat-dissipating aluminium body. The coating is resistant to common detergents. The plastics used for the actuator housing are also detergent-resistant.

### 5.2.1 Special characteristics of the 2-way globe control valve (Type 3361):

- Simple and quick replacement of the screwed-in valve seat.
- Large expansion space above the valve seat that prevents body erosion caused by cavitation.
- Optimal valve selection for the application.  
By default, 3 variants with different Cv values are available for each DN (5 variants of different Cv values for DN ½").

## 5.3 Variants

The following variants are described in these instructions:

#### Type 3360:

- Electromotive angle seat control valve with position control function
- Electromotive angle seat control valve with process control function

#### Type 3361:

- Electromotive globe control valve with position control function
- Electromotive globe control valve with process control function

### 5.3.1 Variants (valve sizes and actuator sizes)

Angle seat control valve Type 3360 AG2:

Available actuator size in nominal force [N]							
DN connection (valve body)		Seat size valve					
[DN]	[NPS]	15	20	25	32	40	50
15	1/2	1300	-	-	-	-	-
20	3/4	-	1300	-	-	-	-
25	1	-	-	1300	-	-	-
32	1 1/4	-	-	-	1300, 2500	-	-
40	1 1/2	-	-	-	-	1300, 2500	-
50	2	-	-	-	-	-	1300, 2500

Table 1: Angle seat control valve variants, Type 3360 AG2

**Angle seat control valve Type 3360 AG3:**

Available actuator size in nominal force [N]				
DN connection (valve body)		Seat size valve		
[DN]	[NPS]	40	50	65
40	1 1/2	7700	-	-
50	2	-	7700	-
65	2 1/2	-	-	10000

Table 2: Angle seat control valve variants, Type 3360 AG3

**Globe control valve Type 3361 AG2:**

Available actuator size in nominal force [N]												
DN connection (valve body)		Seat size valve										
[DN]	[NPS]	3	4	6	8	10	15	20	25	32	40	50
10	3/8	1300	1300	1300	1300	1300	-	-	-	-	-	-
15	1/2	1300	1300	1300	1300	1300	1300	-	-	-	-	-
20	3/4		-	-	-	1300	1300	1300	-	-	-	-
25	1		-	-	-	-	1300	1300	1300	-	-	-
32	1 1/4		-	-	-	-	-	1300	1300	1300, 2500	-	-
40	1 1/2		-	-	-	-	-	-	1300	1300, 2500	1300, 2500	-
50	2		-	-	-	-	-	-	-	1300, 2500	1300, 2500	1300, 2500

Table 3: Globe control valve variants, Type 3361 AG2

**Globe control valve Type 3361 AG3:**

Available actuator size in nominal force [N]						
DN connection (valve body)		Seat size valve				
[DN]	[NPS]	40	50	65	80	100
40	1 1/2	7700	-	-	-	-
50	2	7700	7700	-	-	-
65	2 1/2	10000	10000	10000	-	-
80	3	-	10000	10000	10000	-
100	4	-	-	10000	10000	10000

Table 4: Globe control valve variants, Type 3361 AG3



### 5.3.2 Options

- Energy storage system (SAFEPOS energy-pack) for reaching safety position.  
The safety position that the valve is supposed to take in the event of a supply voltage failure is specified in the SAFEPOS menu.
- Various fieldbus systems for transmitting the control parameters.
- Display module with buttons for touch operation.
- SIM card for saving and transmitting device-specific values and settings.

## 6 STRUCTURE AND FUNCTION

The electromotive control valve consists of an electromotive linear actuator, a control cone and a 2-way globe valve body or a 2-way angle seat valve body.

The control electronics and “SAFEPOS energy-pack” are housed in the side of the linear actuator.

The control electronics consist of the microprocessor-controlled electronic mechanism and the position sensor.

The actuation electronics assembly for position control or process control is actuated either via standard signals (analogue) or a fieldbus (digital).

Standard devices are operated with 2 buttons and 4 DIP switches, while devices with a display module can be display-operated.

The electromotive linear actuator consists of a brushless direct current motor, a gear and a threaded spindle. The valve spindle connected to the threaded spindle transfers the force to the control cone.

- The linear actuator does not use any electrical energy when holding the valve position. This means that, when idling, only the control electronics require energy.
- The stainless steel valve body aids in flow and facilitates high flow rates.
- The self-adjusting packing gland guarantees a high degree of tightness.
- The control cone is connected to the actuator spindle via a spring-type straight pin, and can thus be quickly replaced.
- The actuator housing consists of a robust and heat-dissipating aluminium body with a detergent-resistant coating. The plastics used are also detergent-resistant.
- The flow direction is always below the valve seat.

### Valve seat:

- For a globe control valve, the valve seat is screwed-in. The seat size can easily be reduced by exchanging the screwed-in valve seat.
- For an angle seat control valve, the valve seat is machined into the valve body. This means the seat size cannot be reduced.

The valve seat is always closed against the medium flow. The flow direction must thus be such that the flow reaches the valve below the seat.

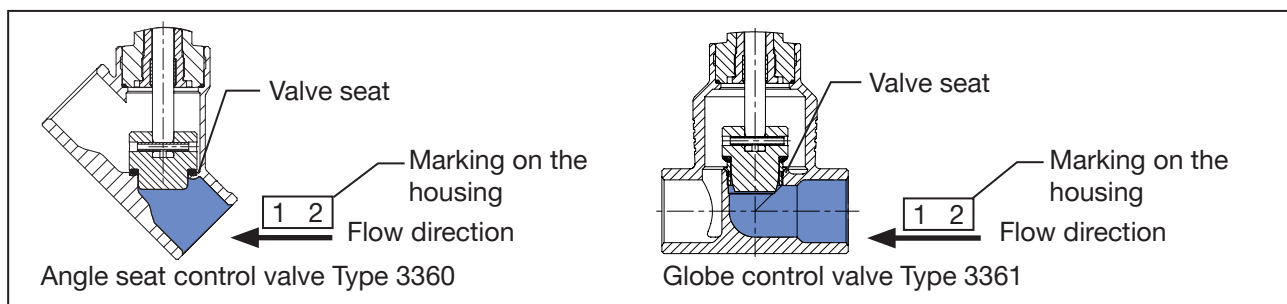

Fig. 1: Flow direction below seat, flow direction

### Fluidic connections:

- The threaded socket connection, welded connection or clamp connection are available for all valve bodies.
- The valve body with flange connection is also available for globe control valve Type 3361.

## 6.1 Representation – Structure of the electromotive control valve AG2

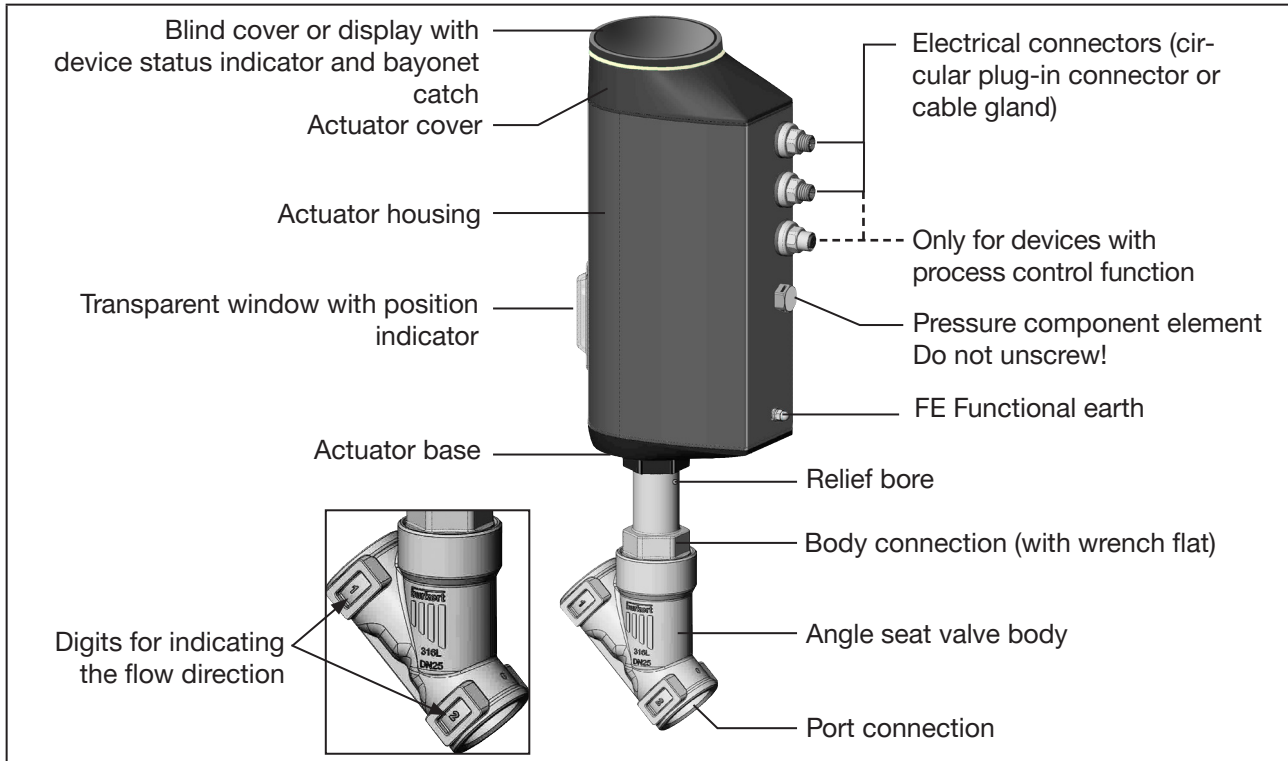

Fig. 2: Assembly, electromotive angle seat control valve Type 3360 AG2

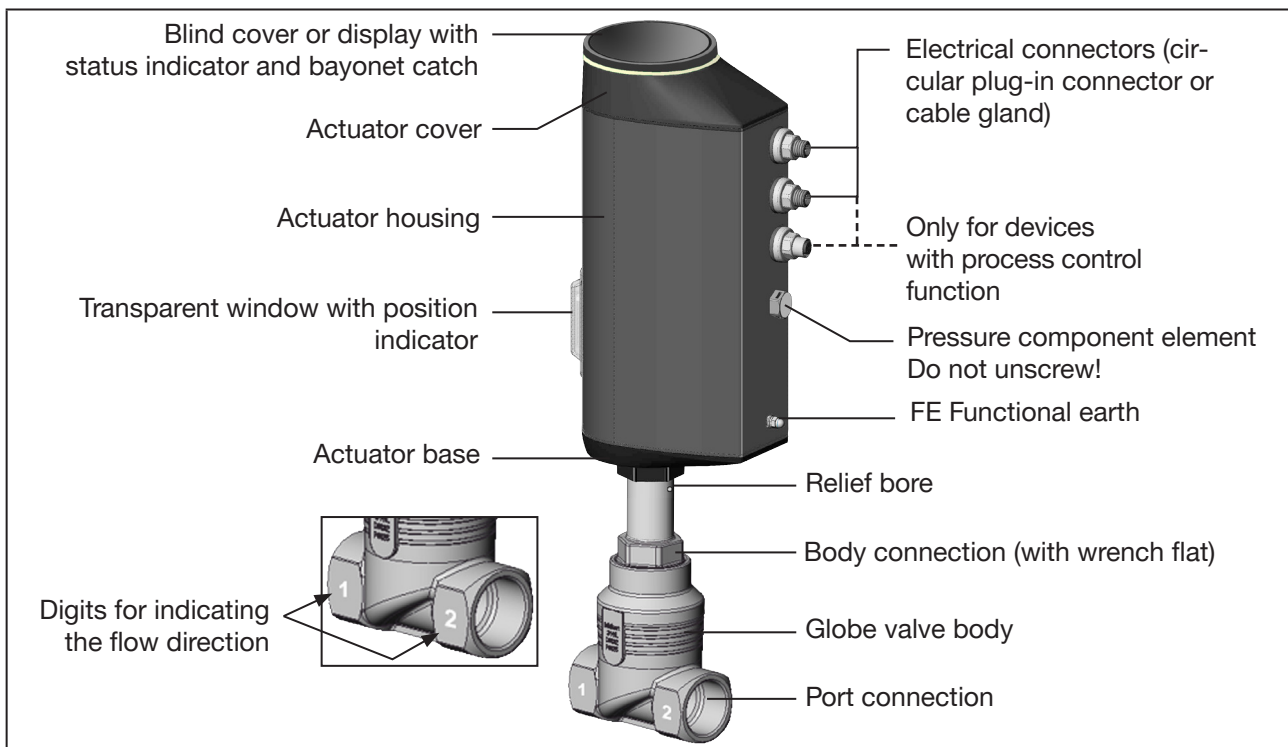

Fig. 3: Assembly, electromotive globe control valve Type 3361 AG2

## 6.2 Representation – Structure of the electromotive control valve AG3

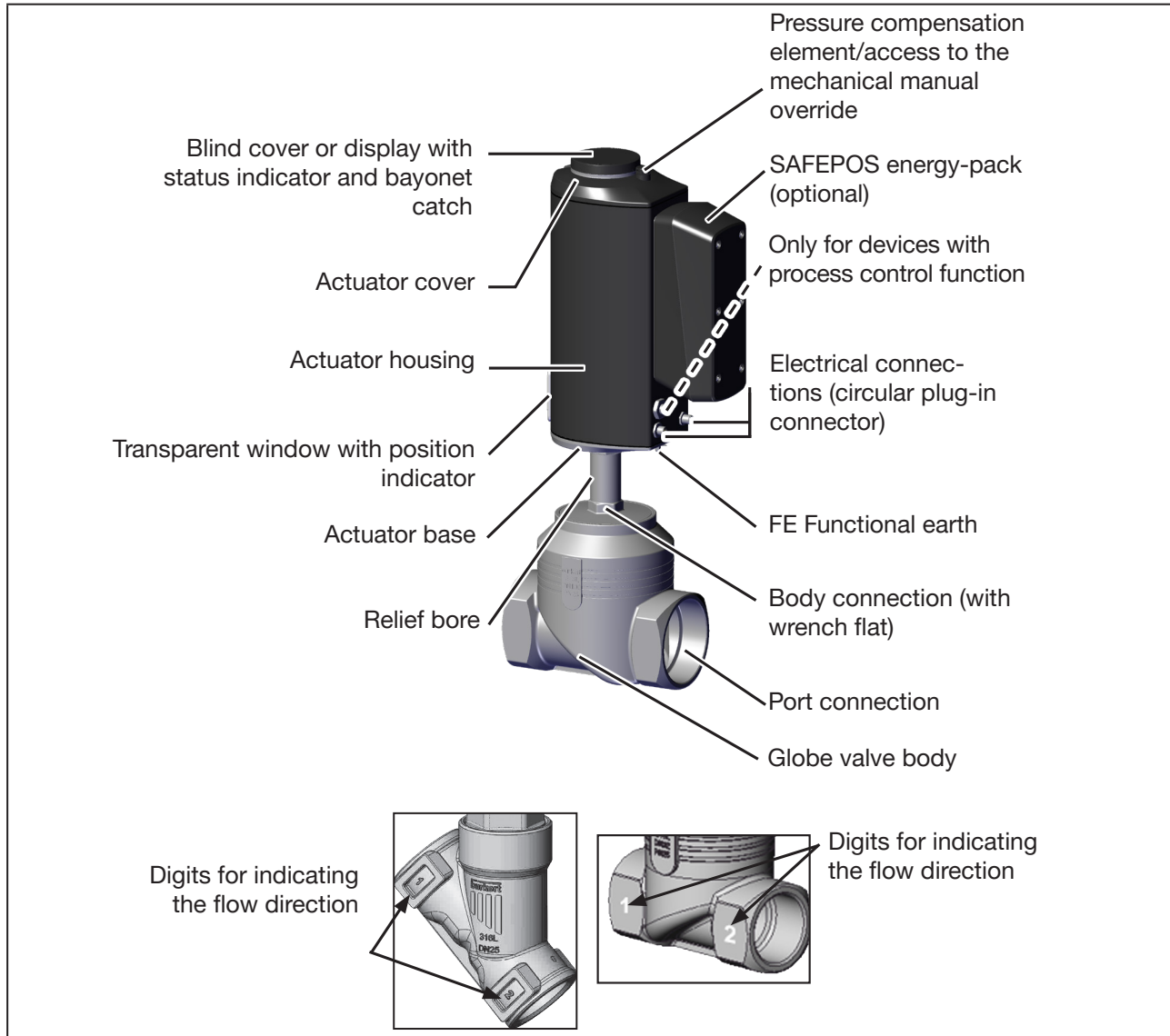

Fig. 4: Assembly, electromotive angle seat control valve Type 3360 AG3

## 6.3 Valve position after supply voltage failure

**Valve position for devices without the SAFEPOS energy-pack energy storage:**

If the electromotive actuator idles upon a supply voltage failure, the valve remains in the last position that it was in.

If the supply voltage fails while the actuator is changing the valve position, the valve remains in an undefined position. The flywheel mass of the actuator and the operating pressure continue to influence the valve spindle until it finally idles.

### Valve position for devices with the SAFEPOS energy-pack energy storage:

The valve assumes the safety position defined in the SAFEPOS menu.



For a description of the SAFEPOS energy-pack energy storage system, see chapter [“7.3 Energy storage SAFEPOS energy-pack \(option\)”](#) on page 31

## 6.4 Safety position

The safety position that the valve assumes in the following scenarios is defined in the SAFEPOS menu:

- Internal error
- Cable break if parameterised accordingly
- Digital input if parameterised accordingly
- Supply voltage failure (optional)  
This function is only available in devices that have the optional SAFEPOS energy-pack energy storage accessory.

The following safety positions are available to choose from in the SAFEPOS menu:

- Close = valve closed
- Open = valve opened
- User-Defined = freely defined safety position input by a per cent value (0% = closed, 100% = open).
- Inactive = valve remains in an undefined position in the event of a supply voltage failure.

## 6.5 Display of the device status

The device status is displayed on the LED light ring. Various LED modes may be configured to display the device's status and valve position:

- Valve mode
- Valve mode + warnings (factory pre-set)
- NAMUR operation mode



\* The description for setting the LED mode can be found in chapter "12.2.2 Set LED operation mode" on page 88.

### 6.5.1 Valve mode

The valve position and device status "Failure" are displayed in the valve mode.



Notifications on device statuses "Out of specification", "Maintenance required" and "Function check" are not displayed in the valve mode.

The factory-set colours for displaying the valve positions "open" and "closed" can be switched. The described can be found in the software description for Types 3360, 3361 on our homepage [country.burkert.com](http://country.burkert.com)

#### Displays in valve mode:

If device status "Normal": Continuously lit in the colour of the valve position.

For device status "Failure": Alternating flashing between red and the valve position colour.

Valve position	Colour for valve position	Colour for device status "Failure"
open	yellow	red
in between	white	
closed	green	

Table 5: Display of device status in valve mode

### 6.5.2 Valve mode + warnings

In this operation mode, the valve position and device statuses "Failure", "Out of specification", "Maintenance required" and "Function check" are displayed.

If several device statuses exist simultaneously, the device status with the highest priority is displayed. The priority is based on the severity of the deviation from standard operation (red = failure = highest priority).

#### Displays in valve mode + warnings:

For device status "Normal": Continuously lit in the colour of the valve position.

For device statuses that deviate from "Normal": flashes alternately with the colours for the valve position and the device status.

Valve position	Colour for valve position	Colour for device status			
		Failure, error or fault	Function check	Outside of specification	Maintenance required
open	yellow	red	orange	yellow	blue
in between	white				
closed	green				

Table 6: Display of device status in valve mode + warnings

### 6.5.3 NAMUR operation mode

In NAMUR mode the LED light ring lights up in the colour specified for the device status as per NAMUR NE 107.

If several device statuses exist simultaneously, the device status with the highest priority is displayed. The priority is based on the severity of the deviation from standard operation (red = failure = highest priority).

Indicators in NAMUR operation mode:

Status LED in line with NE 107, issue 2006-06-12			
Colour	Colour code	Description	Meaning
red	5	Failure, error or fault	Due to a malfunction in the device or its peripherals, closed-loop control mode is not possible.
orange	4	Function check	Work is being carried out on the device, which means that closed-loop control mode is temporarily not possible.
yellow	3	Outside of specification	The environment conditions or process conditions for the device are not within the specified range. Internal device diagnostics indicate problems within the device or with the process properties.
blue	2	Maintenance required	The device is in closed-loop control mode, but function will soon be restricted. → Perform device maintenance.
green	1	Diagnostics active	Device is in error-free operation. Status changes are highlighted in colour. Messages are sent via any fieldbus that may be connected.
white	0	Diagnostics inactive	Device is switched on. Status changes are not displayed. Messages are not transferred via a fieldbus that may be connected.

Table 7: Indication of the device status in NAMUR operation mode



\* A detailed fault description can be found in chapter [“22 Troubleshooting and messages”](#) on page [157](#).

### 6.5.4 Flashing of the LED light ring

Flashing indicates that a connection with the software Bürkert Communicator has been established.

### 6.5.5 Notifications on device status

Notifications on device status are recorded in the logbook. Chapter [“21 Maintenance”](#) contains the most common notifications and the measures that they require.

**Notifications on device status “Function check”**

The notifications are presented when closed-loop control mode is interrupted by work on the device.

Notifications on device status “Function check”
MANUAL operating state active
X.TUNE active
P.TUNE active
P.LIN active
Process simulation active
Signal generator active

Table 8: Notifications on device status “Function check”

## 6.6 Factory settings



**Operating state:**

Devices in their factory default state have their operating state preset to MANUAL.

The pre-set factory settings for the individual menu options can be found in chapter [“17 Operating structure and factory setting”](#).

The factory settings are depicted in blue in the operating structure to the right of the menu.



## 7 CONTROL ELECTRONICS

- **Variants**  
Types 3360, 3361 with position control function  
Types 3360, 3361 with process control function (optional)
- **Position sensor**  
Contact-free, high-resolution and wear-free.
- **Microprocessor-controlled electronics assembly**  
For signal processing, closed-loop control and motor control.
- **Electrical interfaces**  
(circular plug-in connector or cable gland (only AG2))

### 7.6.1 Interfaces

#### AG2 variant

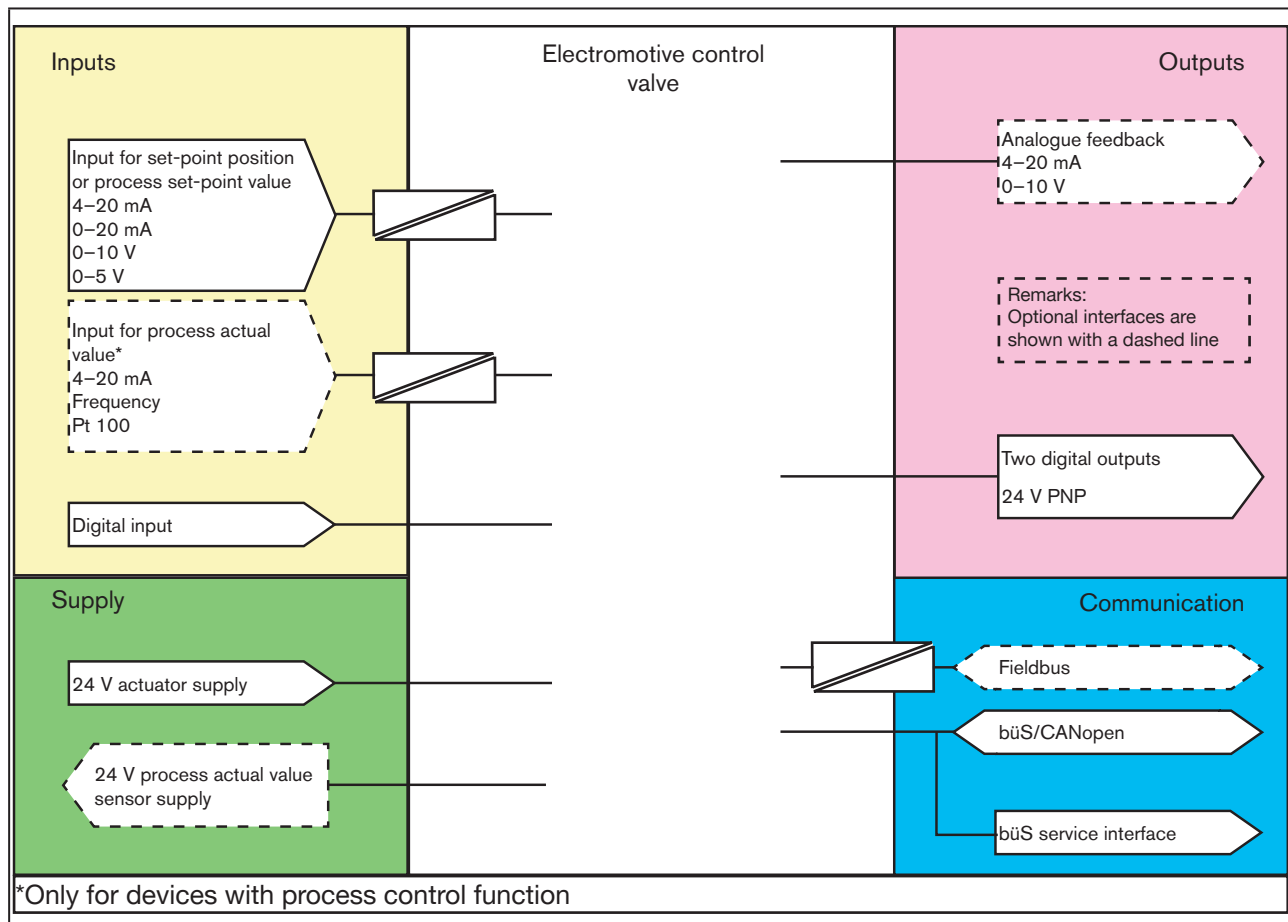

Fig. 5: Overview of galvanic isolations AG2

AG3 Variant

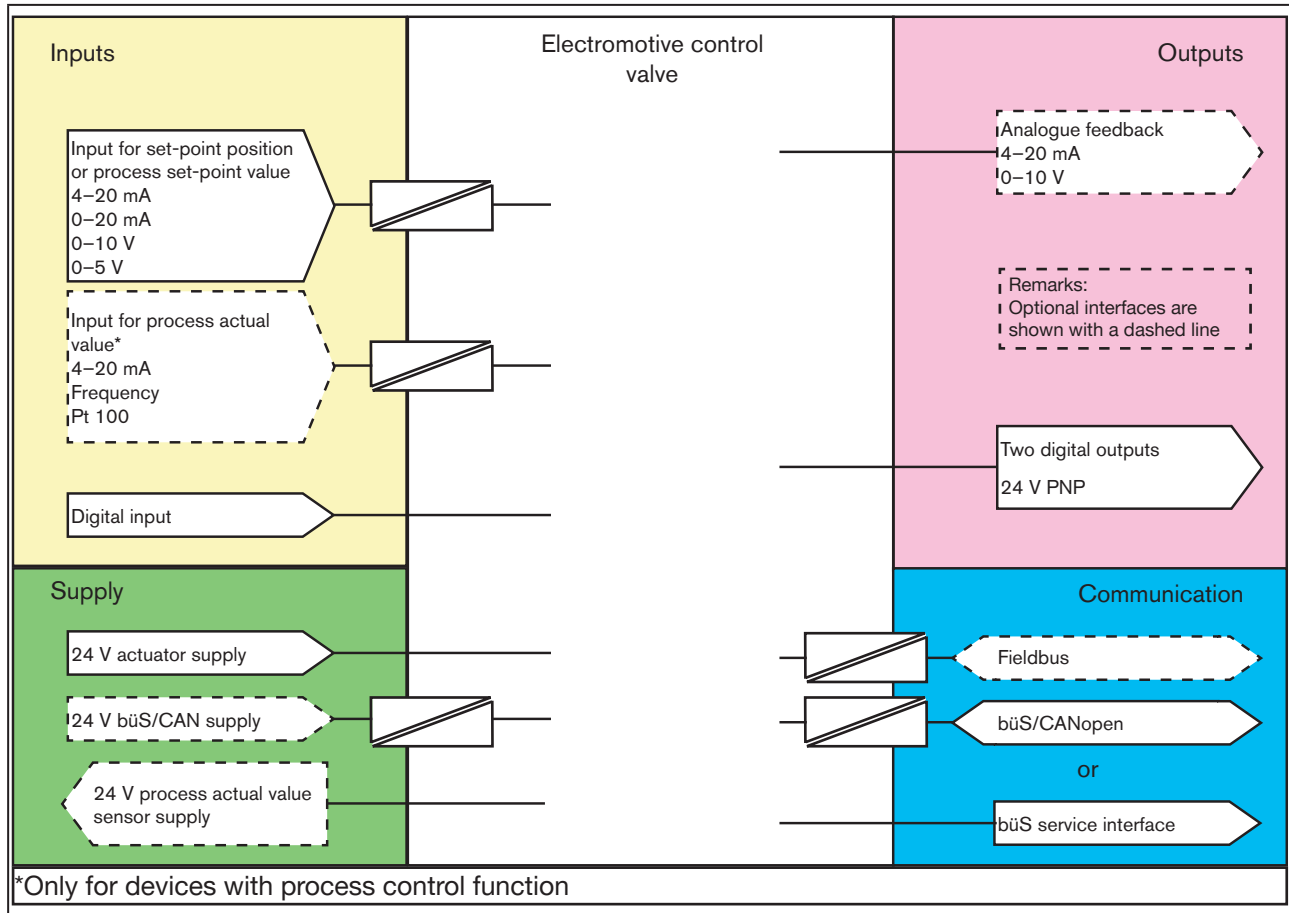

Fig. 6: Overview of galvanic isolations AG3

**!** The electromotive control valve is designed with the three-wire technique, i.e. the electrical supply (24 V DC) is separate from the set-point signal.

## 7.1 Functional diagram of the electromotive control valve

The black parts of the image describe the position control function. The additional elements for the process control function (optional) are depicted in blue.

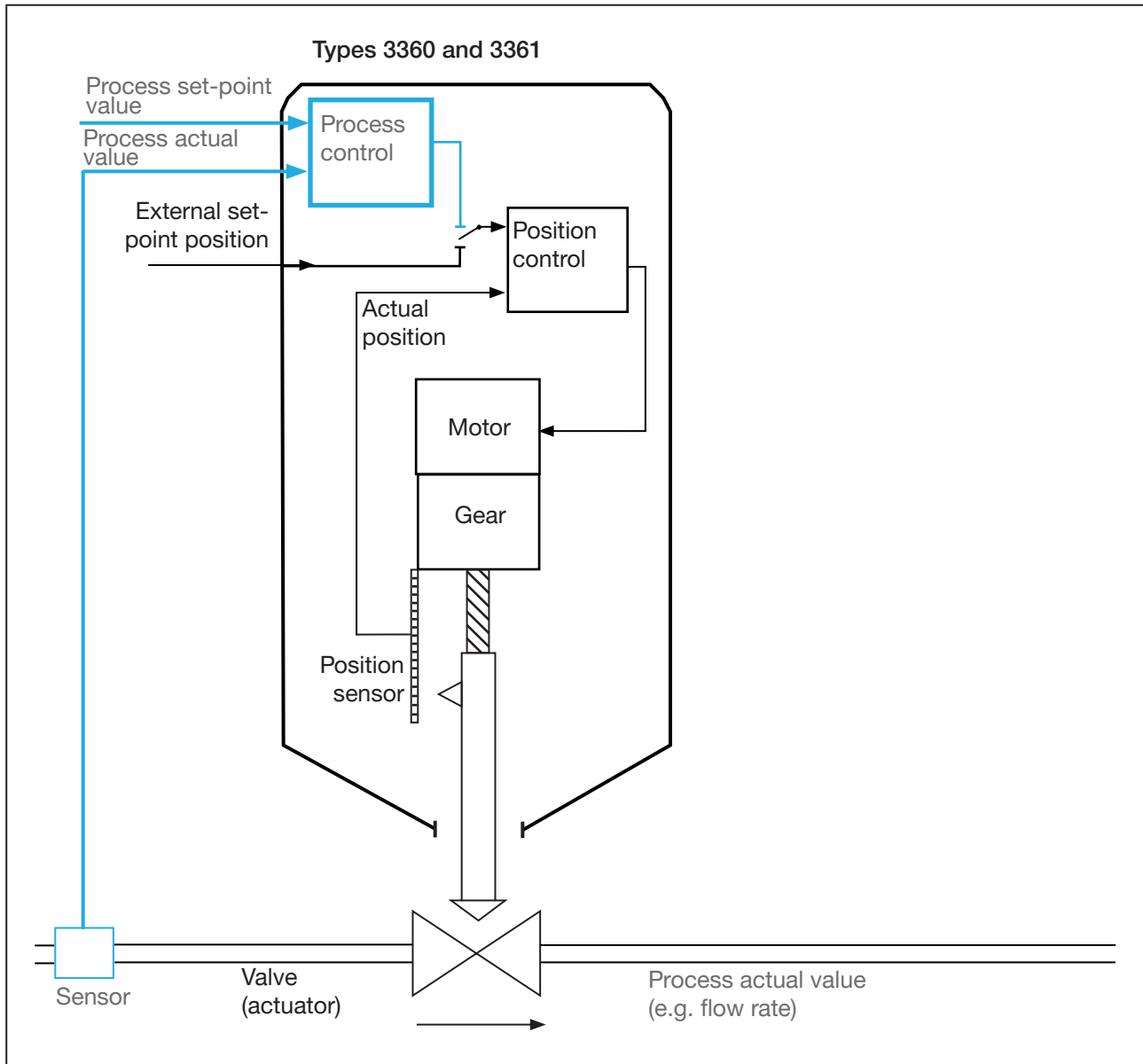

Fig. 7: Functional diagram, electromotive control valve

## 7.2 Functionality of the control electronics

The additionally implemented PID controller can, except for the position control, also be used to conduct a process control (e.g. level, pressure, flow rate, temperature) for purposes of cascade control.

The process control function is integrated in a control loop. The set-point position of the valve is derived from the process set-point value and the process actual value, with the control parameters (PID controller). The process set-point value can be specified by an external signal.

For process control, the position control becomes an auxiliary control loop, which in turn creates a cascade control. The process controller in the main control loop of the control valve has a PID function. The process set-point value (SP) is specified as the set-point value and compared with the actual value (PV) of the measured variable being controlled. The position sensor records the actual position (POS) of the electromotive linear actuator. The position control compares this actual position with the set-point value (CMD) of the process control. If there is a control difference ( $X_{d1}$ ), the actuating variable (CTRL) is used to change the actual position (POS) and thus the valve opening.

### Signal flow diagram

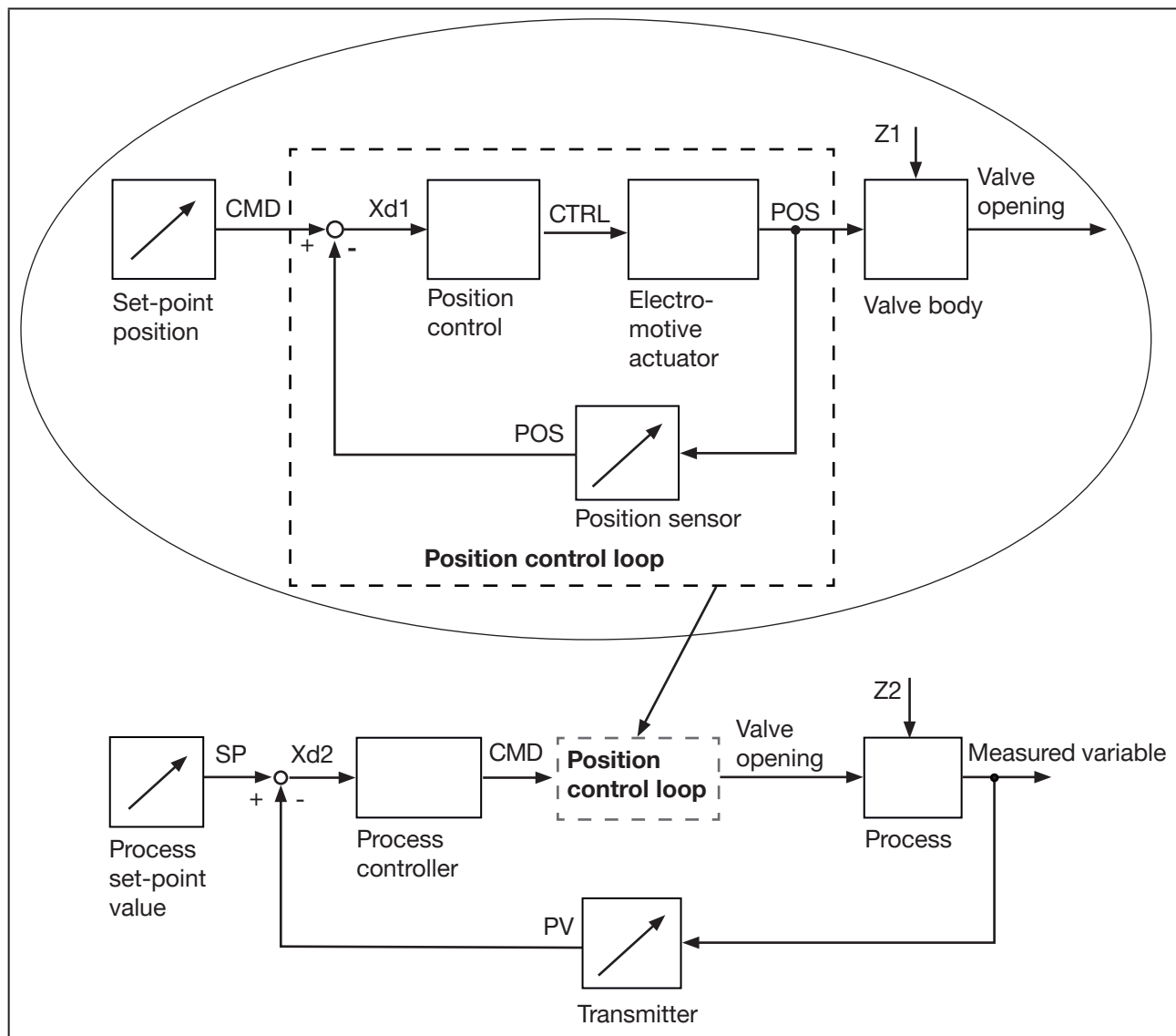

Fig. 8: Signal flow diagram

## 7.2.1 Schematic presentation of the position control

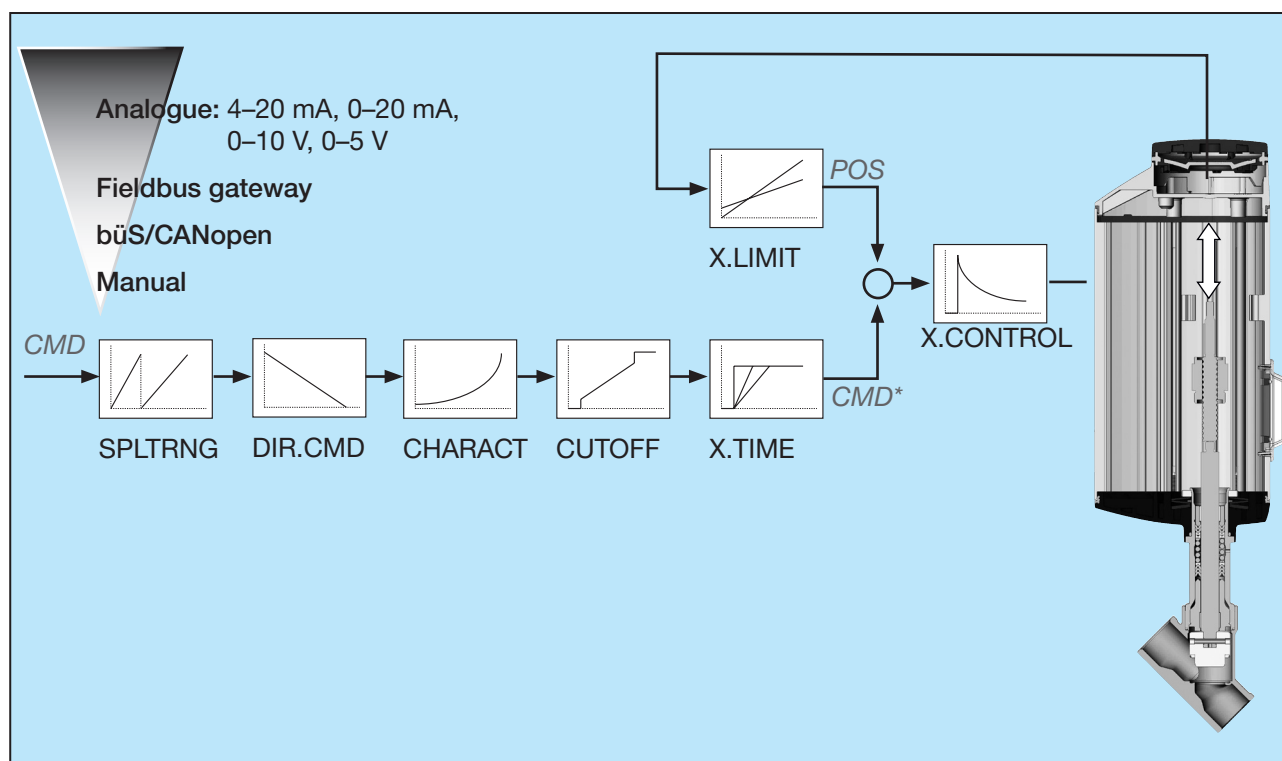

Fig. 9: Schematic presentation of the position control

Legend for the schematic representation of position control and process control:

Menu	Description
X.LIMIT	Mechanical stroke range limit
DIR.CMD	Set-point position direction
SPLTRNG	Signal split range
CHARACT	Transfer characteristic
CUTOFF (type X.CO) (type P.CO)	Sealing function (based on set-point position) (based on process set-point value)
X.TIME	Position control setting speed limit
X.CONTROL	Position control parameterisation
SP.scale	Scaling process set-point value
SP.SLOPE	Increase rate per unit of time
SP.FILTER	Process set-point value filter
PV.scale	Scaling process actual value
PV.FILTER	Process actual value filter
PID.PARAMETER	Process control parameterisation
P.CO. scale	Scaling process control

Table 9: Legend, position control and process control menu

Measured variables	Description
POS	Actual position
CMD	Set-point position
	Position controller function: Selection of the source for the input signal of the set-point position in the menu → <b>Inputs/outputs</b> → <b>CMD</b> → <b>CMD.source</b> . Process controller function: The set-point position is specified by the process controller.
CMD*	Set-point position processed by the controller
PV	Process actual value: Selection of the source for the input signal of the process actual value in the menu → <b>Inputs/outputs</b> → <b>PV</b> → <b>PV.source</b> .
PV*	Process actual value processed by the controller
SP	Process target value: Selection of the source for the input signal of the process set-point value in the menu → <b>Inputs/outputs</b> → <b>SP</b>   <b>CMD</b> → <b>SP.source</b> .
SP*	Process set-point value processed by the controller

Table 10: Legend, position control and process control measured variables

### 7.2.2 Schematic presentation of the process control

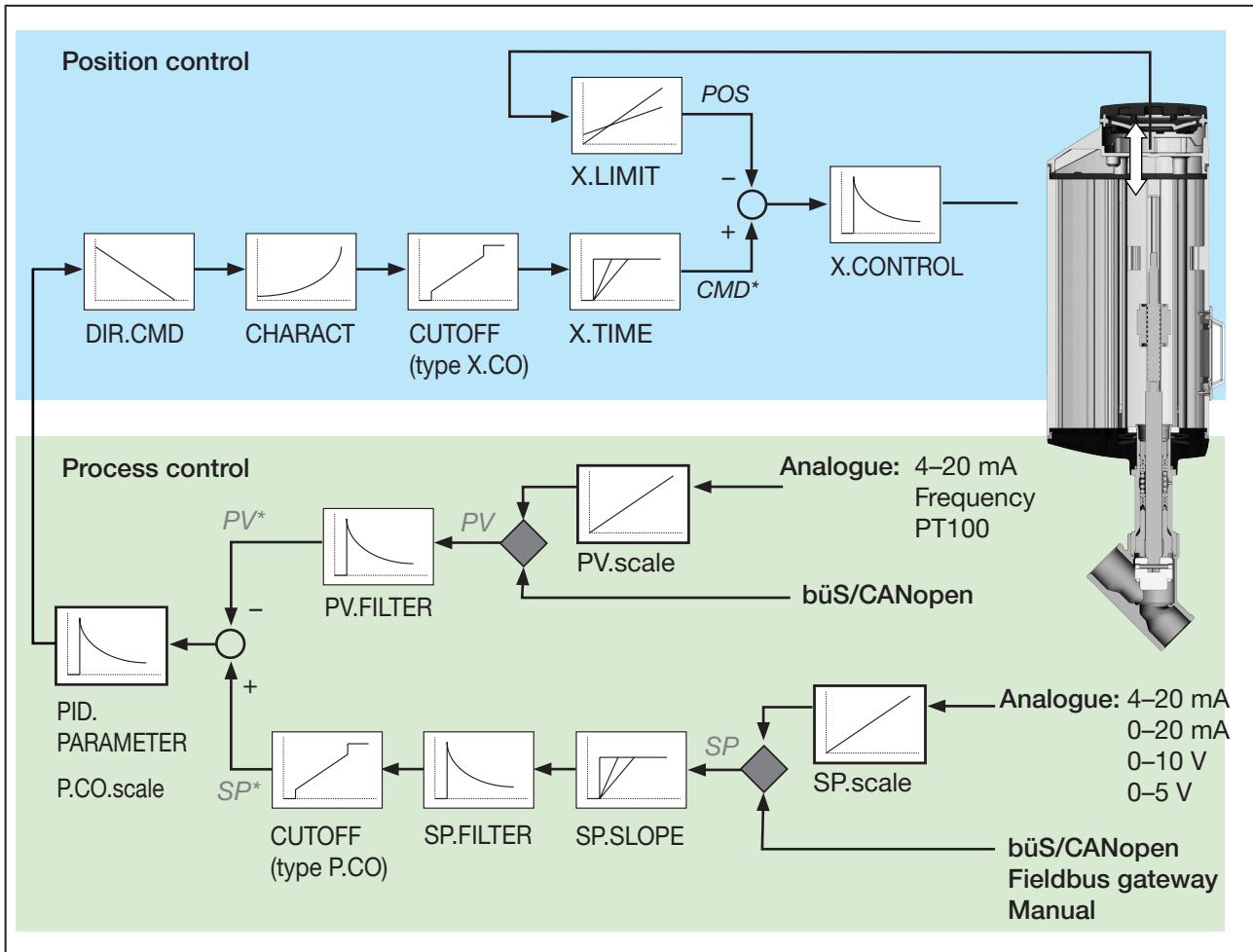

Fig. 10: Schematic presentation of the process control

## 7.3 Energy storage SAFEPOS energy-pack (option)

The device can also be equipped with the energy storage system (SAFEPOS energy-pack). In the event of a supply voltage failure, the energy storage system supplies the actuator with the energy required to move the valve to the safety position.

The safety position is set using the DIP switch or via the display module..

After a maximum of 120 seconds (depending on operating conditions), the energy storage is fully charged and ready for operation

### 7.3.1 Service life

Service life: up to 15 years (depending on operating conditions).

The service life of 5 years was calculated based on the following conditions:

Ambient temperature	30 °C (AG2) / 60 °C (AG3)
Medium temperature	165 °C
Duty cycle	100 %
Operating pressure	5 bar
Nominal diameter	DN32 (AG2) / DN65 (AG3)

#### NOTE!

The energy storage system SAFEPOS energy-pack is a wearing part. The service life figures are approximate values that cannot be guaranteed.

### 7.3.2 Notifications on the state of the SAFEPOS energy-pack

**The device issues a warning:**

The capacity of the energy storage is strongly decreased. The energy pack needs to be replaced soon.

- ▶  The SAFEPOS energy-pack must be promptly replaced before the end of its service life.

**The device issues an error alert and assumes the safety position:**

The SAFEPOS energy-pack was not promptly replaced before issuance of the warning. The storage capacity is so low that assumption of the safety position can no longer be guaranteed.

### 7.3.3 Replace SAFEPOS energy-pack (AG2)



#### CAUTION!

Risk of injury due to electrical voltage.

- ▶ Turn off the supply voltage before removing the SAFEPOS energy-pack.
- ▶ Ensure that the SAFEPOS energy-pack is fully discharged. Wait until the LED ring is no longer lit and ensure that the LED status is not in "LED off" mode (see chapter ["12.2.1 LED illuminated ring"](#)).

The SAFEPOS energy-pack energy storage system is located in the actuator housing. Remove the following parts from the actuator for replacement:



Devices with ATEX approval or IECEx approval are secured with a magnetic lock.

The removal of the cover is described in the supplementary instructions for the electromotive control valves with ATEX approval and IECEx approval.

1. Blind cover
2. LED & storage module
3. Actuator cover

The process for removing these parts is described in detail in chapter [“10.3.2 Access to connection terminals”](#) on page 66.

**Removing SAFEPOS energy-pack:**

- Loosen the safety screw (hexalobular-internal screw T10).
- Completely pull the SAFEPOS energy-pack out from the clamp.

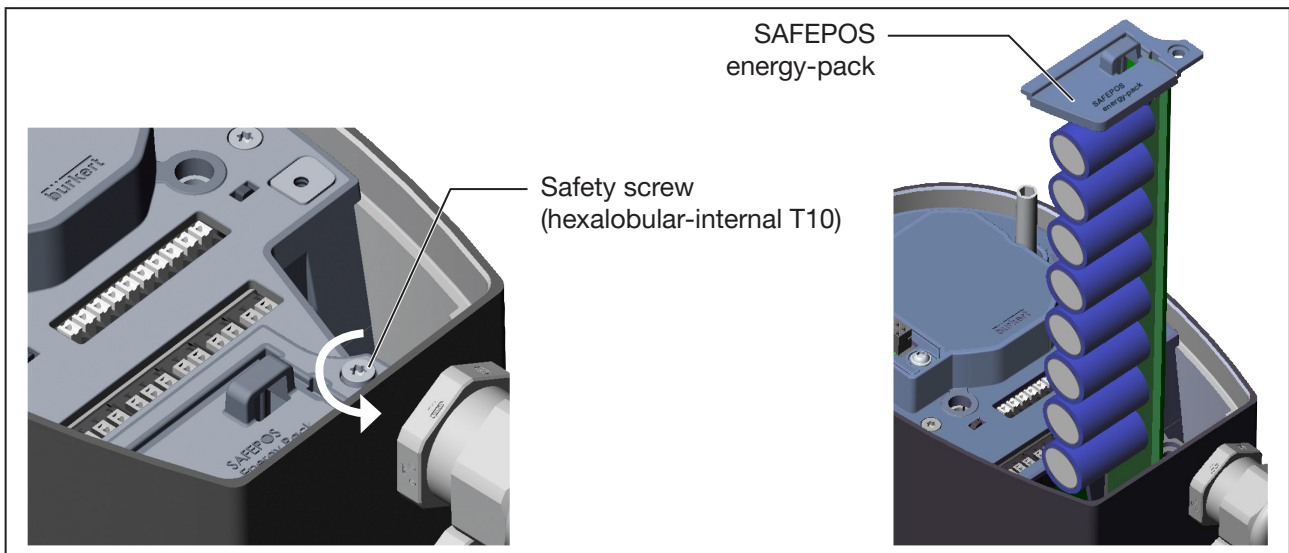

Fig. 11: Removing SAFEPOS energy-pack

**Inserting new SAFEPOS energy-pack:**

- Remove the SAFEPOS energy-pack from the transport packaging.
- Insert the SAFEPOS energy-pack into the two guide grooves on the side and push it in until it stops.



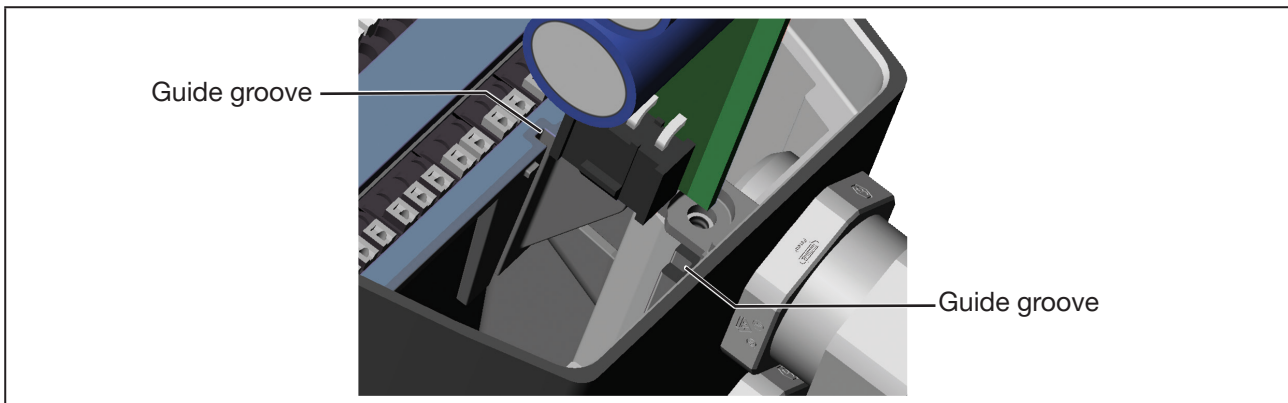

Fig. 12: Inserting SAFEPOS energy-pack

→ Apply the safety screw (hexalobular-internal screw T10).

→ Connect supply voltage.

### 7.3.4 Replace SAFEPOS energy-pack (AG3)

#### **!** CAUTION!

Risk of injury due to electrical voltage.

- ▶ Turn off the supply voltage before removing the SAFEPOS energy-pack.
- ▶ Ensure that the SAFEPOS energy-pack is fully discharged. Wait until the LED ring is no longer lit and ensure that the LED status is not in “LED off” mode (see chapter “12.2.1 LED illuminated ring”).

The SAFEPOS energy-pack energy storage system is located on the actuator housing. Remove the following parts from the actuator for replacement:

#### Remove SAFEPOS energy-pack cover:

→ Remove 6 fastening screws (hexalobular-internal screws T25).

→ Remove cover.

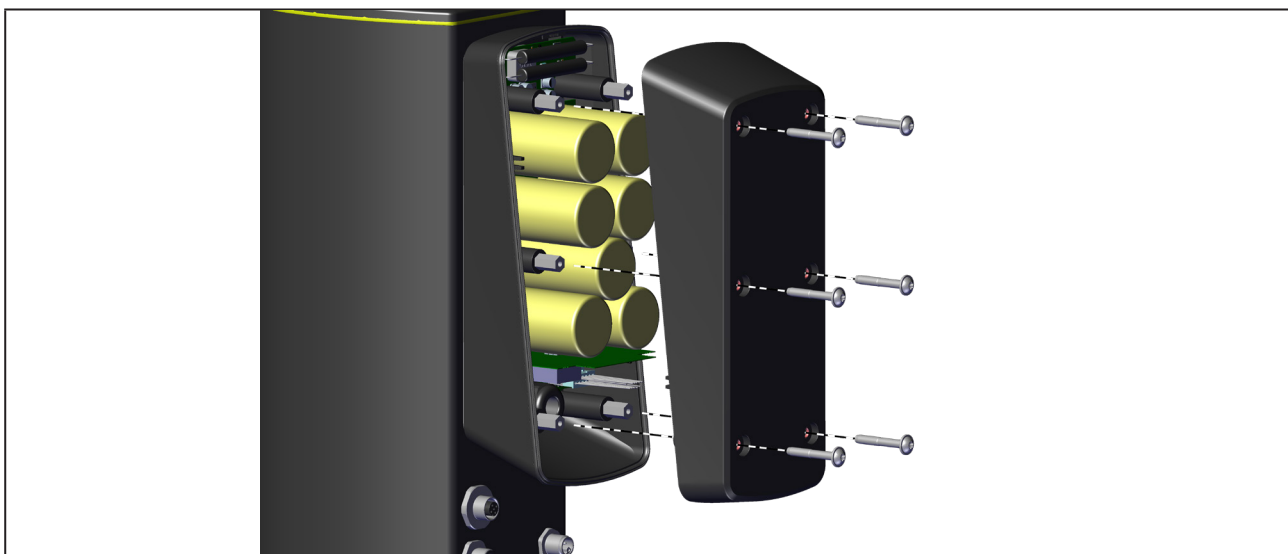

Fig. 13: Take off SAFEPOS energy-pack cover

Removing SAFEPOS energy-pack:

**! CAUTION!**

Risk of injury due to electrical voltage.

- ▶ Ensure that the red LED to display the residual voltage has gone out before the components are touched.

- Remove printed circuit board.
- Remove adapter cable.

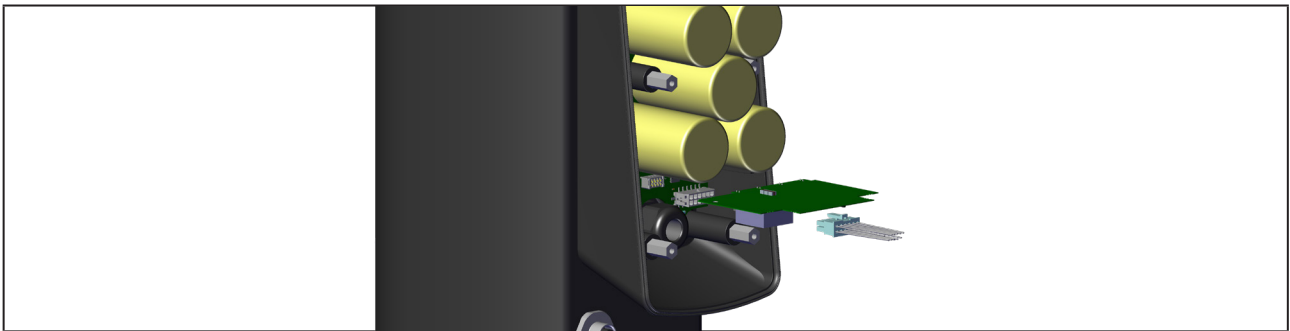

Fig. 14: Remove printed circuit board and adapter cable

- Loosen 4 cheese head screws (socket head screw AF3).
- Remove the SAFEPOS energy-pack.



Fig. 15: Loosen screws on the printed circuit board/remove SAFEPOS energy-pack

Inserting new SAFEPOS energy-pack:

- Remove the SAFEPOS energy-pack from the transport packaging.
- Installation in reverse order.

- !** Tighten 4 cheese head screws (socket head screw AF3) to 1.1 Nm tightening torque.
- Tighten 6 fastening screws (T25 hexalobular-internal screws) to 3 Nm tightening torque.

## 8 TECHNICAL DATA



The following product-specific information is provided on the type label:

- Voltage [V] (tolerance  $\pm 10\%$ ) and type of current
- Seal material
- Fieldbus standard
- Flow capacity
- Actuator size
- Maximum permitted operating pressure
- Flow direction
- Temperature specifications

### 8.1 Standards and directives

The device complies with the valid EU harmonisation legislation. In addition, the device also complies with the requirements of the laws of the United Kingdom.

The harmonised standards that have been applied for the conformity assessment procedure are listed in the current version of the EU Declaration of Conformity/UK Declaration of Conformity.

### 8.2 Approvals

The product is cULus listed. Refer to chapter “8.6 Electrical data” for information on use in UL environments.

### 8.3 Type label

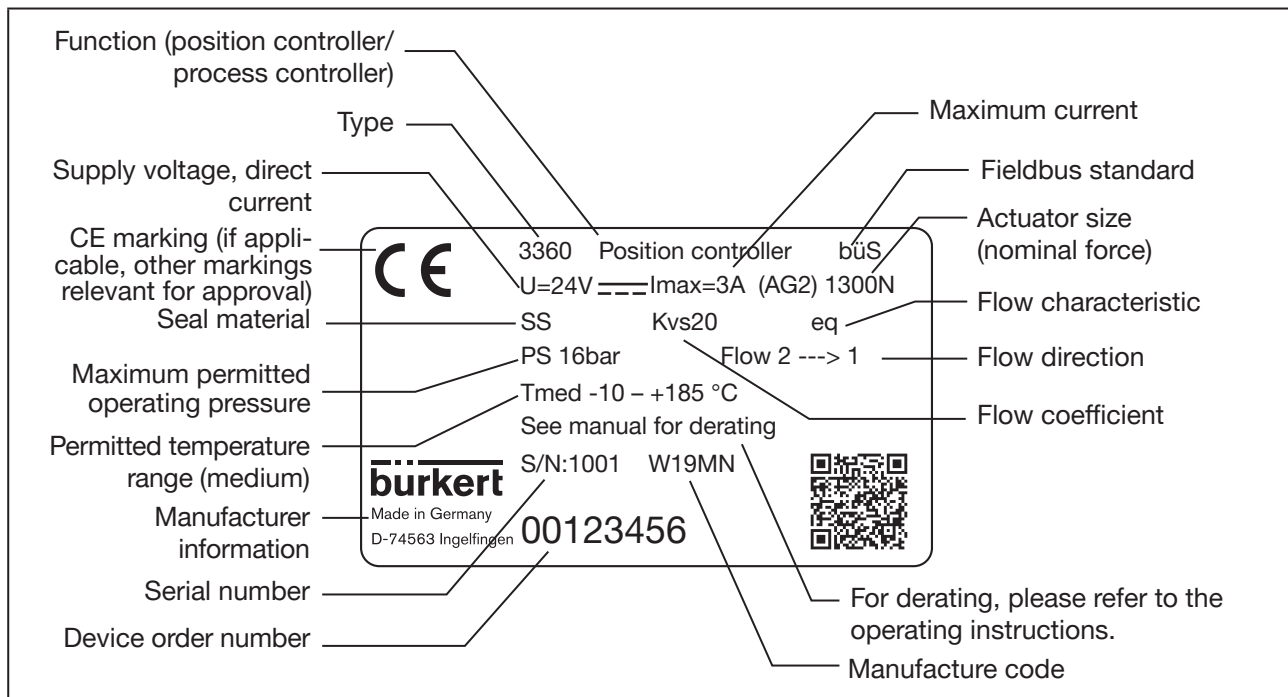

Fig. 16: Description of the type label (example)

### 8.3.1 UL additional label (example)

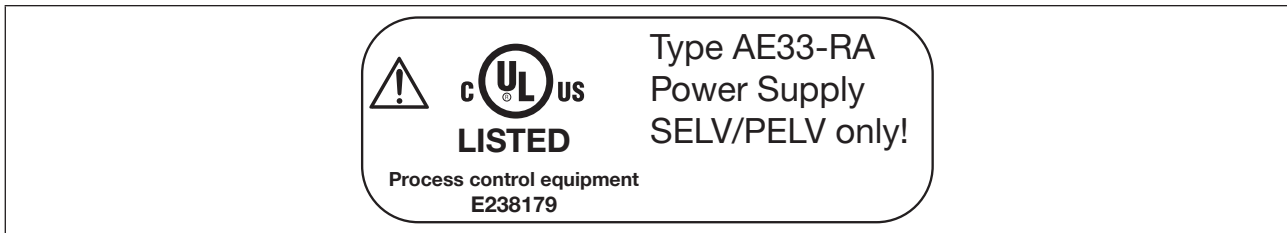

Fig. 17: UL additional label (example)

## 8.4 Operating conditions



The product-specific information on the type label must be heeded when operating the device.



### WARNING!

Loss of function if operated below or above permitted temperature range.

- ▶ Never expose the device to direct sunlight in outdoor areas.
- ▶ Do not operate above or below the permitted ambient temperature range.



### WARNING!

Reduced sealing function if operating pressure too high.

Because the valve seat is closed against the medium flow, an excessive operating pressure may cause the valve seat to not close tightly.

- ▶ The operating pressure must not exceed the maximum value specified on the type label.

Maximum permitted operating pressure:	see type label, depending on usage limits of the armature (derating operating pressure)
Media:	neutral gases and steam. Liquid media: water, alcohol, oil, fuel, hydraulic fluid, salt solution, caustic soda, organic solvent.
Degree of protection:	(verified by Bürkert/not evaluated by UL) IP65 and IP67 in accordance with IEC 529, EN 60529. NEMA 250 4x (not guaranteed for installation position: actuator facing downwards) (only for AG2, for AG3 on request).
Flow direction:	indicated on the type label with an arrow and the digits 1 and 2. The 1 and 2 are also on the valve body for identification. The flow direction is below the seat with flow from port 2 to port 1.
Altitude	Up to 2000 m above sea level

### 8.4.1 Permitted temperature ranges

Minimum temperatures	Environment:	-25 °C
	Medium:	-10 °C (-40 °C on request)
Maximum temperatures	Environment:	depends on the medium temperature, see subsequent temperature diagram.
	Medium:	depends on the ambient temperature; see temperature diagram below, as well as usage limits of the valve (derating operating pressure). For devices with PTFE valve seat seal max. +130 °C. For devices with stainless steel or PEEK valve seat seal max. +185 °C (+230 °C on request).

#### Temperature diagram

The maximum permitted temperature for the environment and medium are dependent on one another. The permitted maximum temperatures must be determined using the temperature diagram.

The values are calculated under the following maximum operating conditions:

AG2: Nominal diameter DN32 at 100% duty cycle with 16 bar operating pressure.

AG3: Nominal diameter DN65 at 100% duty cycle with 25 bar operating pressure.

Individual reviews may be performed under different operating conditions. For this, please contact your Bürkert branch office.

#### AG2

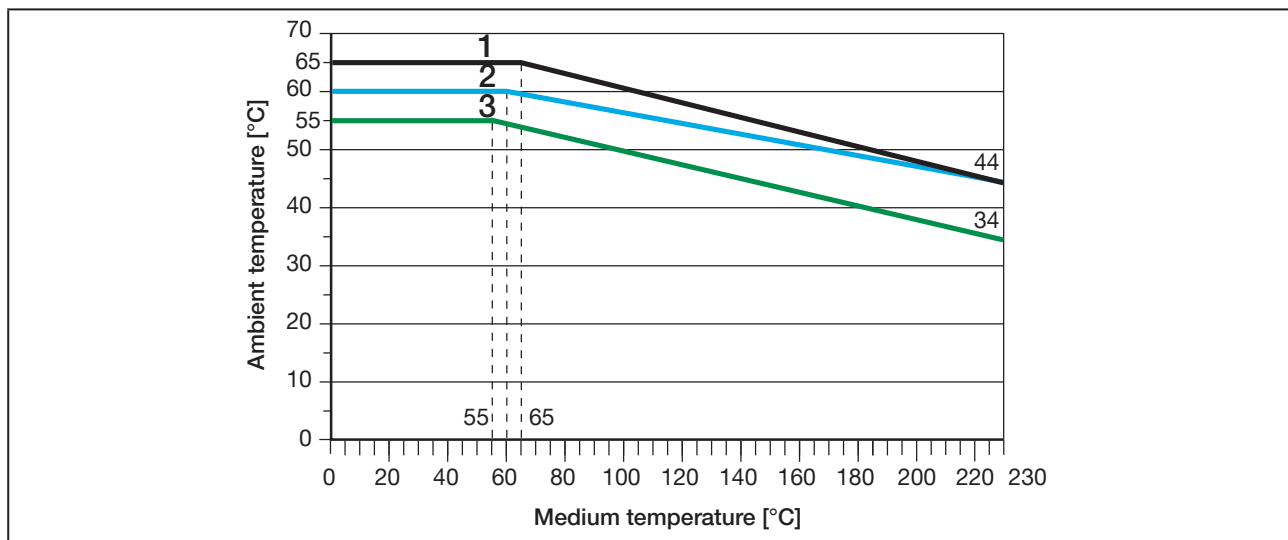

Fig. 18: Temperature diagram AG2

No.	Description
1	Device without module
2	Devices with display module
3	Devices with SAFEPOS energy-pack* or fieldbus gateway, with or without display module

\* The service life of the SAFEPOS energy-pack is dependent on the medium temperature and ambient temperature (see chapter "Electrical data").

Table 11: Description of temperature diagram AG2

AG3

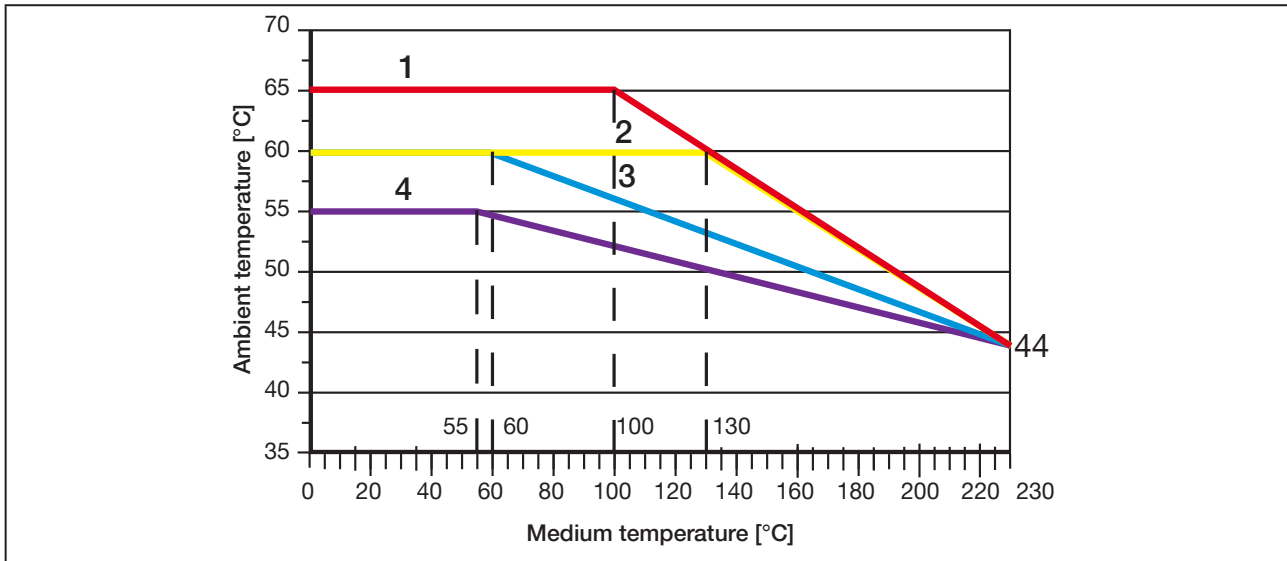

Fig. 19: Temperature diagram AG3

No.	Description
1	Device without module
2	Devices with SAFEPOS energy-pack*
3	Devices with display module with/without SAFEPOS energy-pack*
4	Devices with fieldbus gateway with/without display module with/without SAFEPOS energy-pack*

\* The service life of the SAFEPOS energy-pack is dependent on the medium temperature and ambient temperature (see chapter "Electrical data").

Table 12: Description of temperature diagram AG3

**Derating pressure and temperature range**

Usage limits of the valve (derating operating pressure)

Medium temperature	Operating pressure
-10...+50 °C	25 bar
100 °C	24.5 bar
150 °C	22.4 bar
200 °C	20.3 bar
230 °C	19 bar

Table 13: Derating the operating pressure as per DIN EN 12516-1/PN25

Medium temperature	Operating pressure
-29...+38 °C	19 bar
50 °C	18.4 bar
100 °C	16.2 bar
150 °C	14.8 bar
200 °C	13.7 bar
230 °C	12.7 bar

Table 14: Derating the operating pressure as per ASME B16.5/ASME B16.34 Cl.150

Medium temperature	Operating pressure
-10...+50 °C	14 bar
100 °C	14 bar
150 °C	13.4 bar
200 °C	12.4 bar
230 °C	11.7 bar

Table 15: Derating the operating pressure as per JIS B 2220 10K

## 8.5 General technical data

Dimensions: see data sheet

Weight: see data sheet

Materials:

Actuator base:	PPS (AG2)/1.4308 (AG3)
Actuator housing:	Aluminium EN AW 6063 powder-coated
Inspection view:	PC
Actuator cover:	PPS (AG2)/PC (AG3)
Valve body:	316L/CF3M
Body connection:	AG2: 316L / 1.4401 AG3: 1.4401 / 1.4404 / 1.4435 / CF3M
Spindle:	1.4401 / 1.4404
Spindle guide:	1.4401/1.4404/316L with carbon-filled PTFE
Packing gland	PTFE V-rings with spring compensation (carbon-filled PTFE)

Seal material:

Actuator housing sealing element:	EPDM
Valve seat seal:	see type label

Fluid connection:

Possible connection types:

- Threaded socket connection G ½–G 4 (NPT, RC on request)
- Welded connection as per EN ISO 1127 (ISO 4200), DIN 11850 series 2
- Clamp connection as per ISO 2852, DIN 32676, ASME BPE, BS 4825

Additionally for Type 3361 globe valve:

- Flange connection as per DIN 2634, ANSI B16.5 class 150, JIS 10K
- Other connections on request

Electrical connection: With terminal connectors (only AG2) or circular plugs

Installation position: any, preferably actuator face up

Sound pressure level: <70 dB (A), may be higher depending on the operating conditions.

Cv value: see type label or chapters [“8.7”](#) and [“8.8”](#)

## 8.6 Electrical data



### WARNING!

Electrical shock.

Protection class III is only guaranteed when using an SELV or PELV power supply unit.

Protection class	3 in accordance with DIN EN 61140
Electrical connections	Devices with position controller function: Terminal strip with cable gland, 2 x M20 (only AG2) or 2 circular plug-in connectors M12, 5-pin and 8-pin  Devices with process control function: Terminal strip with cable gland, 3 x M20 (only AG2) or circular plug-in connectors 2 x M12, 5-pin and 1 x M12, 8-pin

### NOTE!

Consider voltage drop through power supply cable.

Example: With a cable cross-section of 0.34 mm<sup>2</sup> the copper cable must not exceed 8 metres in length.

Operating voltage	24 V $\pm$ 10%, max. ripple 10%
Supply voltage transmitter	24 V $\pm$ 10% only for devices with process control function.
Supply current transmitter	max. 150 mA only for devices with process control function.
Operating current [A]*:	including actuator at max. load and charging current of the optional SAFEPOS energy-pack (charging current approx. 1 A) for the design of the power supply unit

Actuator size	Typical (without charging current SAFEPOS energy-pack)*	Maximum (to design the power supply)*
AG2	2 A	3 A
AG3	3.5 A	5 A



The operating current can be reduced if necessary:

1. Reduce the control speed X.TIME.
2. Devices with SAFEPOS energy-pack: Set "Control if ready" function.

Standby consumption (electronics assembly without actuator) [W]*	1...5 (depending on the level of disassembly)
Protection class	3 according to DIN EN 61140 (VDE 0140)

\* All values relate to a supply voltage of 24 V  $\pm$ 10% at an ambient and medium temperature of 25 °C.

Caution: At minimum ambient and medium temperature, the operating current can be up to 5 A (AG2) or 11 A (AG3) (incl. 1 A charging current of the optional SAFEPOS energy-pack).





The operating current can be reduced by the following measures, if necessary

1. For devices with the SAFEPOS energy-pack energy storage:  
Configuring the “Control if ready” reduces the max. operating current.

Setting in the configuration area **Position controller** → **Parameter** → **SAFEPOS** → **ENERGY-PACK** → **FUNCTION** → **Control if ready**.

2. Reducing the control speed X.TIME.

Setting: Setting in the configuration area **Position controller** → **Parameter** → **ADD.FUNCTION** → **Activate X.TIME** → **X.TIME** → **Opening time** → **Closing time**.

Service life of energy storage  
SAFEPOS energy-pack:

Charging time: maximum 120 seconds (dependent on operating conditions)

Service life: up to 15 years (depending on operating conditions).

The service life of 5 years was calculated based on the following conditions:

ambient temperature	30 °C (AG2)/60 °C (AG3)
Medium temperature	165 °C
Duty cycle	100%
Operating pressure	5 bar
DN	DN32 (AG2) / DN65 (AG3)

**Analogue inputs:** (electrically isolated from the supply voltage and analogue output)

Input data for set-point value signal

0/4...20 mA:	Input resistance	<70 Ω
	Resolution	12 bit
0...5/10 V:	Input resistance	22 kΩ
	Resolution	12-bit, resolution relates to 0–10 V

Input data for actual value signal (optional)

4...20 mA:	Input resistance	<70 Ω
	Resolution	12 bit
Frequency:	Measuring range	up to 1000 Hz
	Input resistance	> 30 kΩ
	Resolution	0.1% from measured value
	Input signal	> 300 mV <sub>ss</sub>
	Signal form	Sine wave, square wave, triangle wave
Pt 100:	Measuring range	-20...+220 °C
	Resolution	0.01 °C
	Measuring current	1 mA

**Analogue output (optional):**

max. current	10 mA (for voltage output 0...5/10 V)
Load	0–800 Ω (for current output 0/4–20 mA)

**Digital outputs (optional):**

PNP, current limit	100 mA
--------------------	--------

**Digital inputs:**

NPN, 0–5 V = log “0”, 10–30 V = log “1”  
inverted input inverted accordingly (input current < 6 mA)

**Communication interface with PC:**

büS service interface, connection is established using the USB büS interface set

**Communication software for PC:**

“Bürkert Communicator”



The digital input, digital outputs and analogue output are not electrically isolated from the operating voltage. They relate to the GND potential of the operating voltage.

Current limit: output voltage is reduced in the event of overload.

## 8.7 Flow rate values and flow rate characteristics for angle seat control valve (Type 3360)

The flow rate values and resulting characteristic depend on the valve seat size.

### 8.7.1 Flow rate values and flow rate characteristic for seat size 15

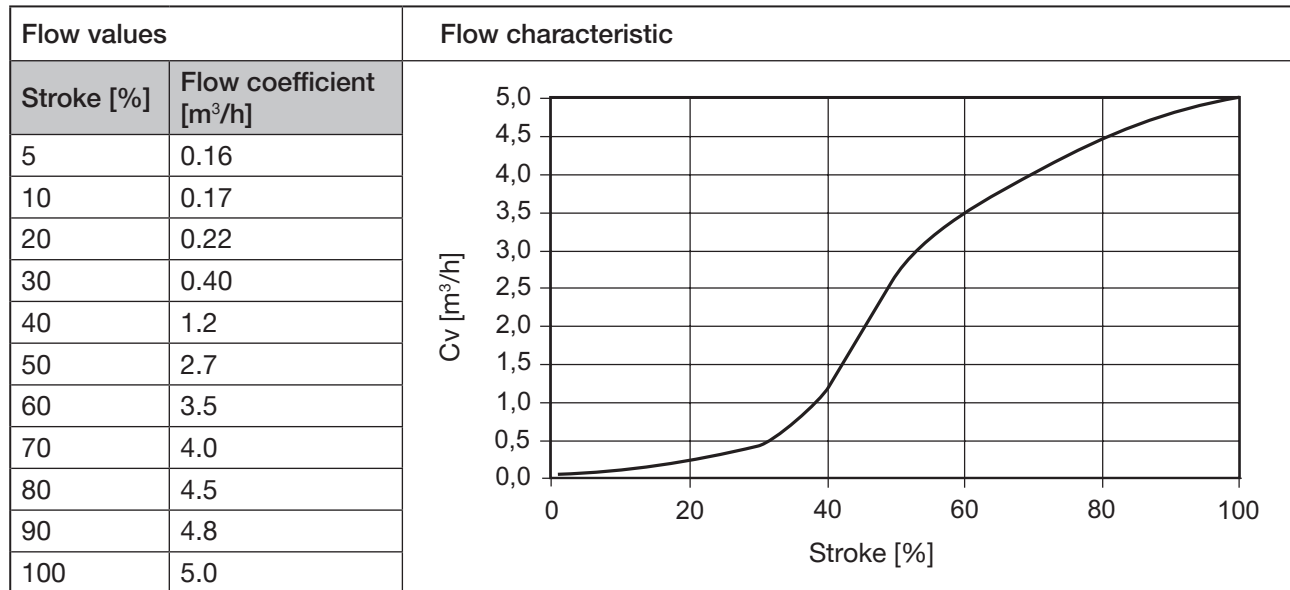

Table 16: Angle seat control valve, flow rate values and flow rate characteristic for seat size 15

### 8.7.2 Flow rate values and flow rate characteristic for seat size 20

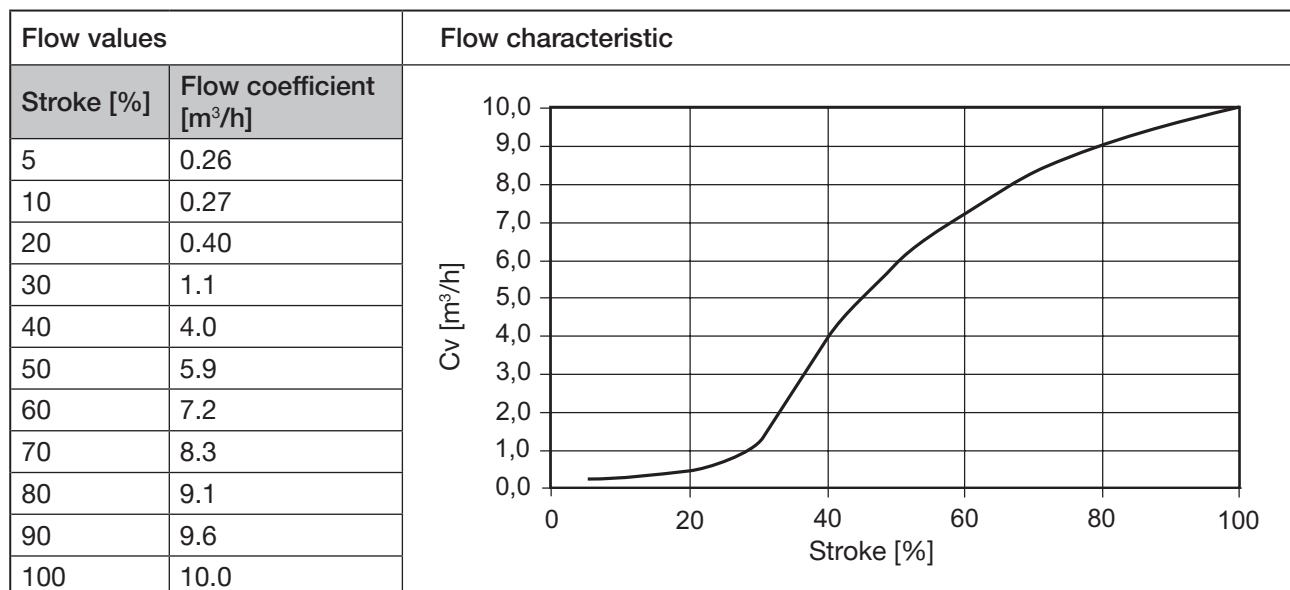

Table 17: Angle seat control valve, flow rate values and flow rate characteristic for seat size 20

### 8.7.3 Flow rate values and flow rate characteristic for seat size 25

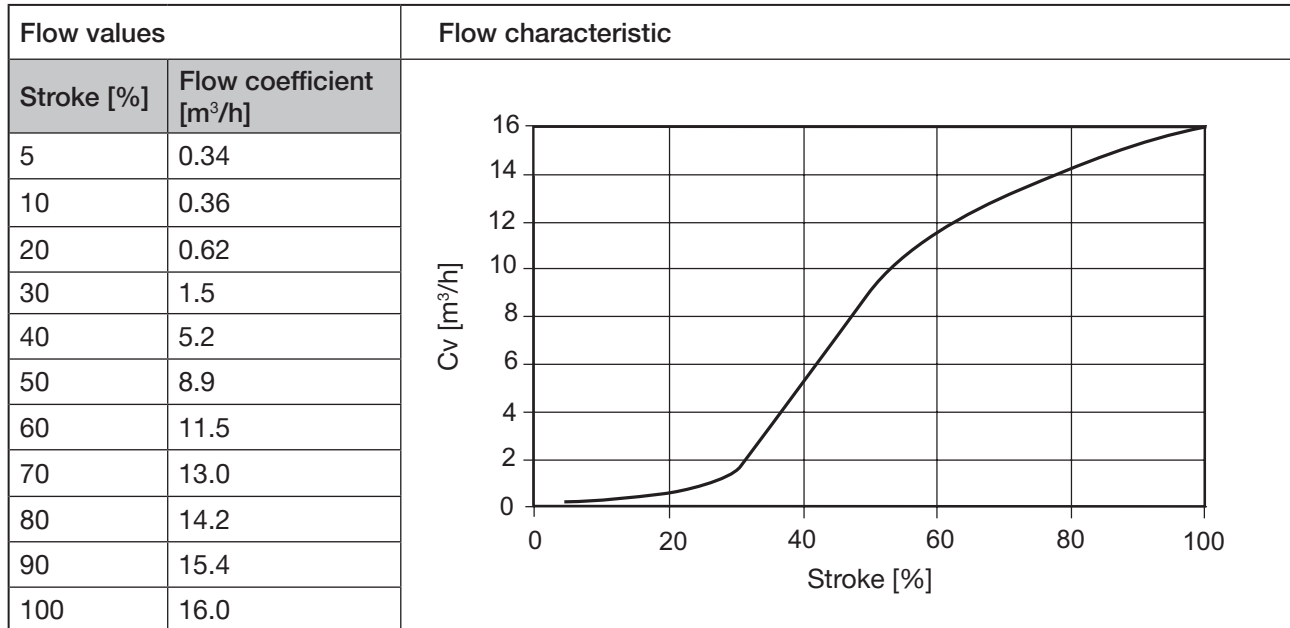

Table 18: Angle seat control valve, flow rate values and flow rate characteristic for seat size 25

### 8.7.4 Flow rate values and flow rate characteristic for seat size 32

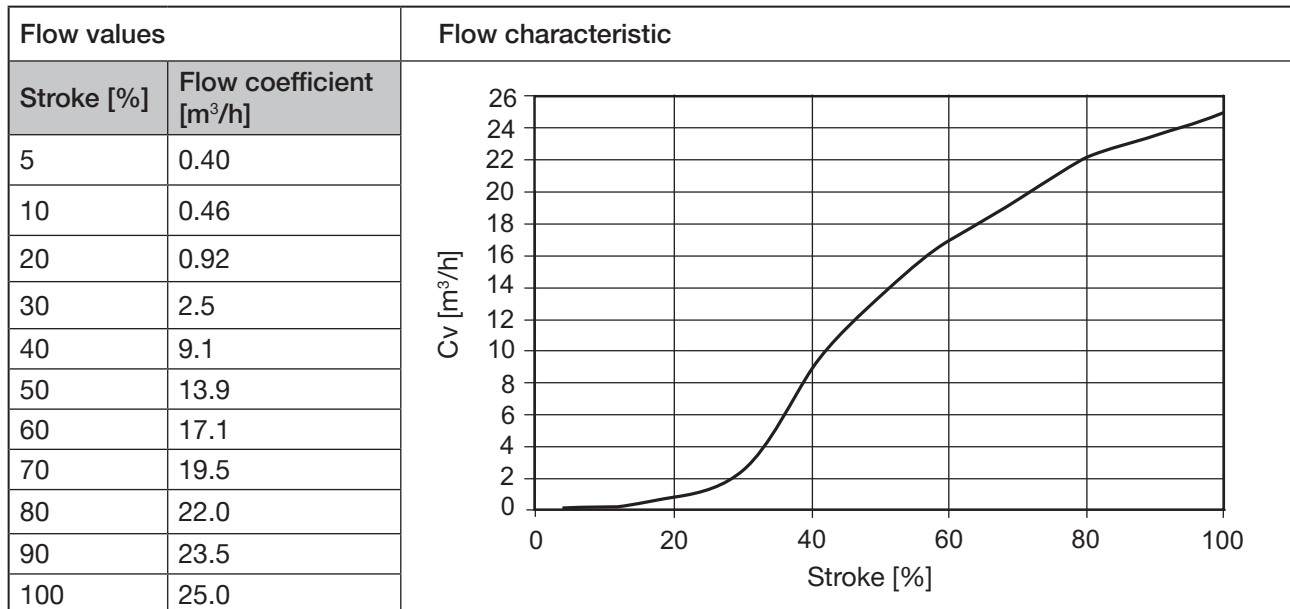

Table 19: Angle seat control valve, flow rate values and flow rate characteristic for seat size 32

### 8.7.5 Flow rate values and flow rate characteristic for seat size 40

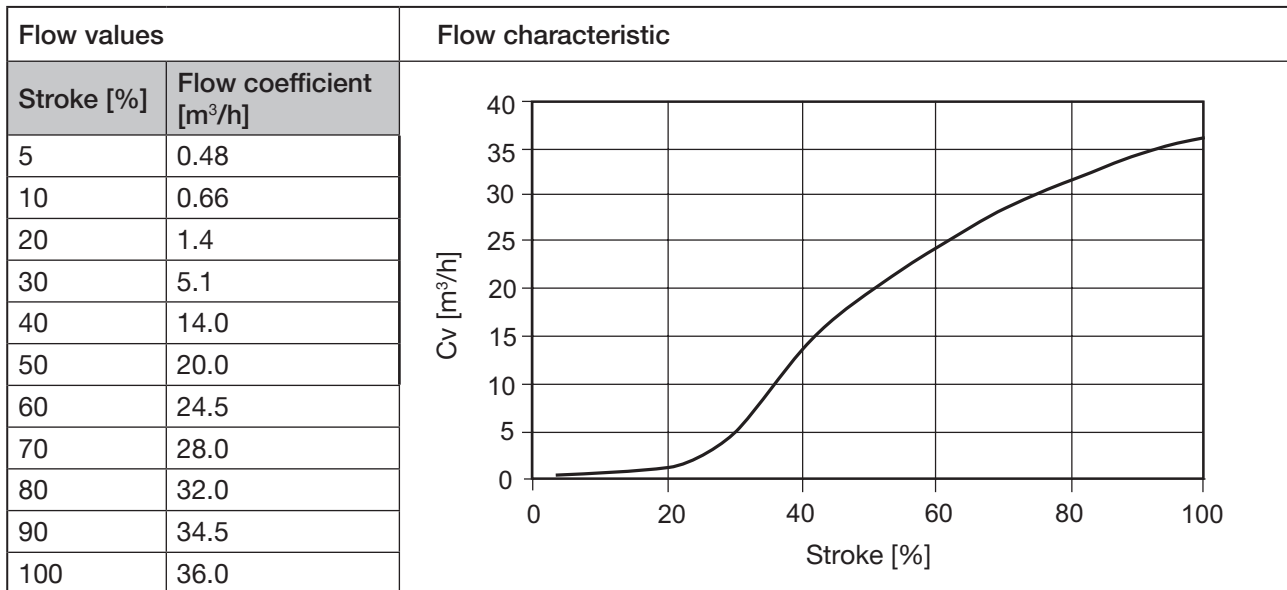

Table 20: Angle seat control valve, flow rate values and flow rate characteristic for seat size 40

### 8.7.6 Flow rate values and flow rate characteristic for seat size 50

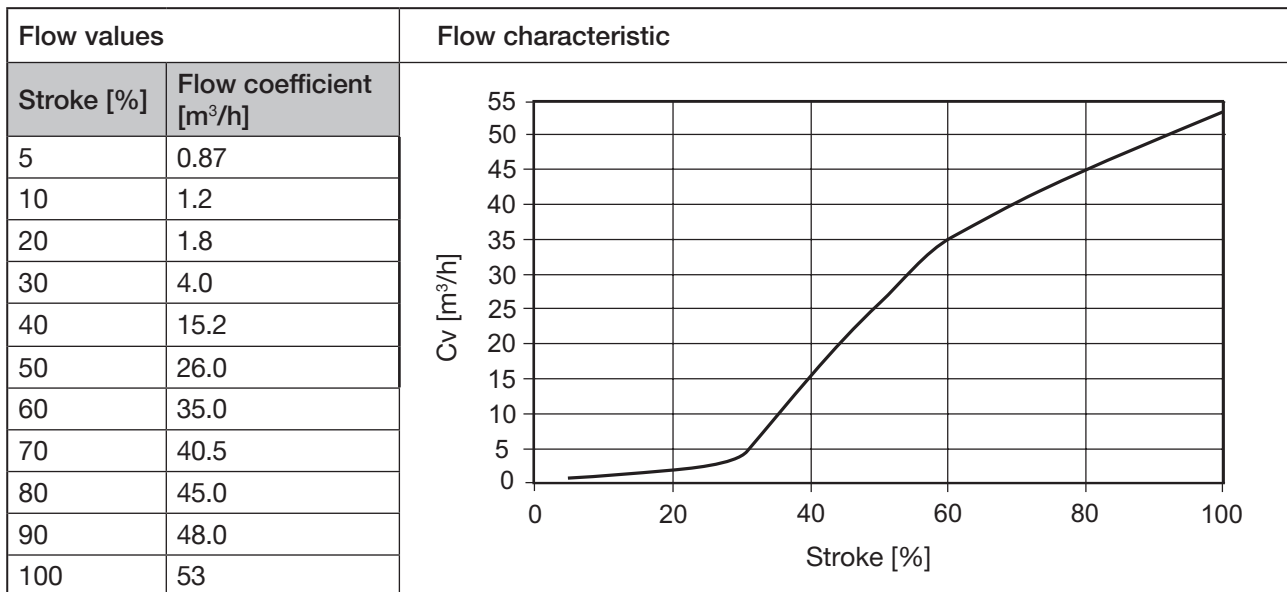

Table 21: Angle seat control valve, flow rate values and flow rate characteristic for seat size 50

### 8.7.7 Flow rate values and flow rate characteristic for seat size 65

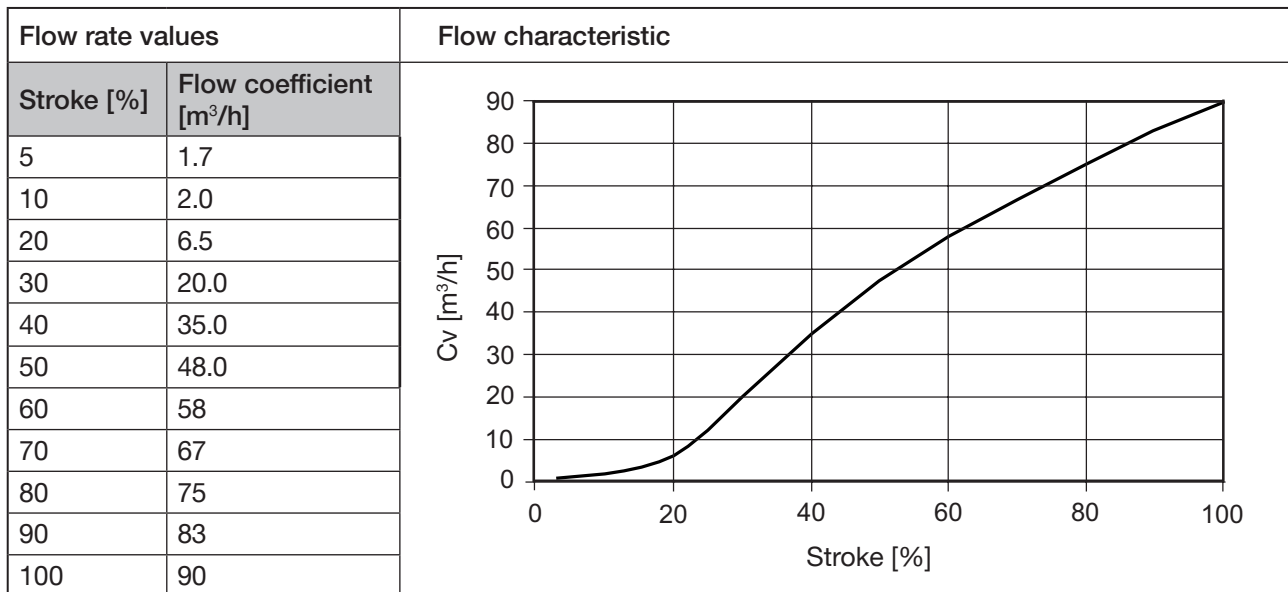

Table 22: Angle seat control valve, flow rate values and flow rate characteristic for seat size 65

## 8.8 Flow rate values and flow rate characteristics for globe control valve (Type 3361)

### 8.8.1 Flow rate characteristics

The globe control valve exhibits various characteristics depending on the valve seat size.

- Parabolic cone of equal per cent for valves with seat size 6–50
- Linear cone for valves with seat size 3–6
- Flow characteristic as per DIN EN 60534-2-4
- Theoretical rangeability ( $Kv_S$ :  $Kv_0$ )
 

Seat size 8–100:	50 : 1
Seat size 6:	25 : 1
Seat size 3–4:	10 : 1
- $Kv_R$  value\* at 5% of the stroke for seat size > 10  
 $Kv$  value at 10% of the stroke for seat size ≤ 10

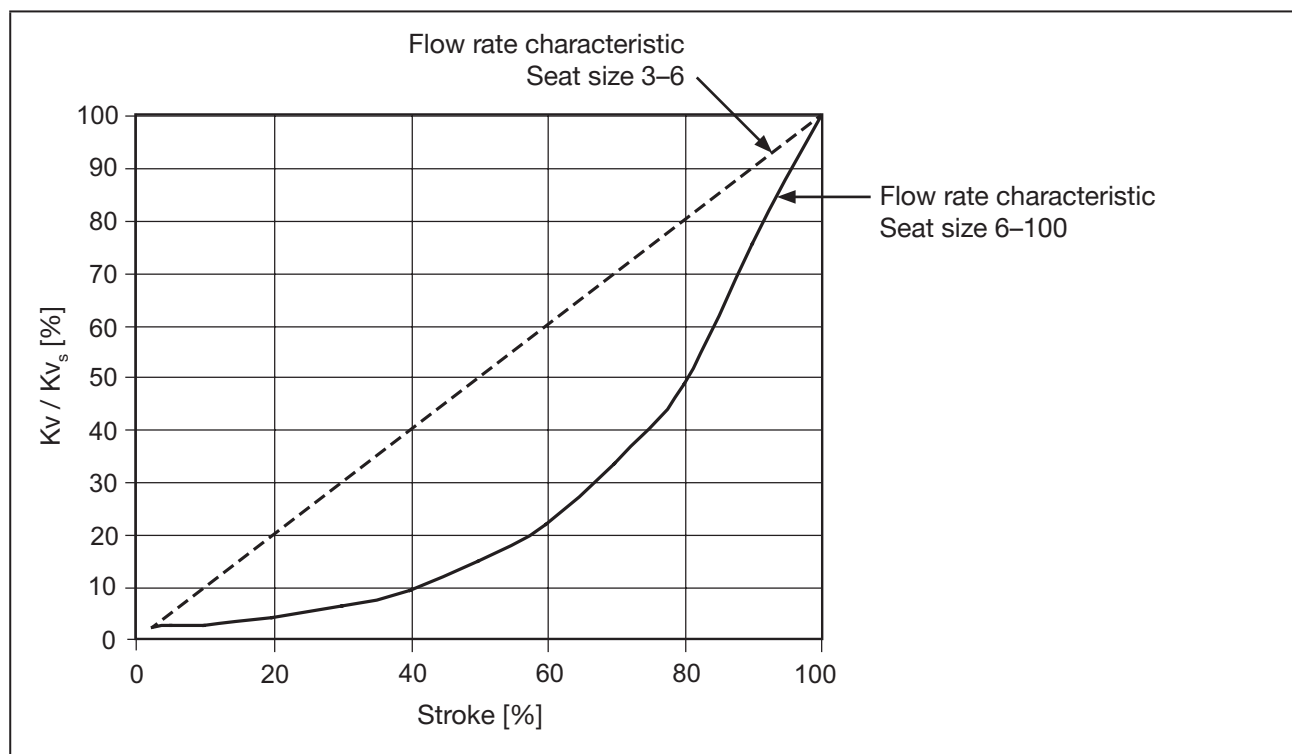

Fig. 20: Flow rate characteristic, globe control valves

\*  $Cv_R$  value = lowest  $Cv$  value at which the tilt tolerance as per DIN EN 60534-2-4 can still be observed.

## 8.8.2 Flow rate values

### KV<sub>s</sub> values

DN connection (valve body)		Kv <sub>s</sub> values													
		Seat size valve													
DN	[NPS]	3	4	6	8	10	15	20	25	32	40	50	65	80	100
10	3/8	0.1	0.5	1.2	2	2.7	-	-	-	-	-	-	-	-	-
15	1/2	0.1	0.5	1.2	2.1	3.1	4.3	-	-	-	-	-	-	-	-
20	3/4	-	-	-	-	3.2	5.2	7.1	-	-	-	-	-	-	-
25	1	-	-	-	-	-	5.3	7.2	12	-	-	-	-	-	-
32	1 1/4	-	-	-	-	-	-	8	13	17.8	-	-	-	-	-
40	1 1/2	-	-	-	-	-	-	-	13.6	20	24	-	-	-	-
50	2	-	-	-	-	-	-	-	-	21	24.5	37	-	-	-
65	2 1/2	-	-	-	-	-	-	-	-	-	25.5	39.5	62	-	-
80	3	-	-	-	-	-	-	-	-	-	-	42	70	100	-
100	4	-	-	-	-	-	-	-	-	-	-	-	75	115	140

Table 23: Kv<sub>s</sub> values, globe control valves

### Kv values

DN connection (valve body)		Seat size valve	Kv values [m <sup>3</sup> /h]										
			Stroke [%]										
DN	[NPS]		5	10	20	30	40	50	60	70	80	90	100
10	3/8	3	-	0.003	0.007	0.015	0.025	0.037	0.052	0.065	0.078	0.090	0.10
		4	-	0.050	0.10	0.16	0.22	0.27	0.32	0.36	0.40	0.44	0.50
		6	-	0.12	0.32	0.48	0.62	0.76	0.88	0.98	1.1	1.1	1.2
		8	-	0.070	0.090	0.12	0.18	0.26	0.42	0.61	0.92	1.5	2.0
		10	-	0.11	0.13	0.19	0.30	0.48	0.73	1.00	1.6	2.3	2.7
15	1/2	3	-	0.003	0.007	0.015	0.025	0.037	0.052	0.065	0.078	0.090	0.10
		4	-	0.050	0.10	0.16	0.22	0.27	0.32	0.36	0.40	0.44	0.50
		6	-	0.12	0.32	0.48	0.62	0.76	0.88	0.98	1.1	1.1	1.2
		8	-	0.080	0.11	0.13	0.19	0.27	0.43	0.63	0.95	1.6	2.1
		10	-	0.11	0.15	0.19	0.31	0.49	0.75	1.1	1.7	2.5	3.1
20	3/4	15	0.14	0.17	0.22	0.35	0.52	0.80	1.2	1.8	2.7	3.7	4.3
		10	0.11	0.12	0.16	0.20	0.33	0.52	0.77	1.2	1.8	2.6	3.2
		15	0.14	0.17	0.22	0.35	0.52	0.80	1.2	1.8	2.9	4.0	5.2
25	1	20	0.20	0.25	0.30	0.45	0.70	1.1	1.6	2.4	3.5	5.2	7.1
		15	0.14	0.17	0.22	0.35	0.52	0.80	1.2	1.8	2.9	4.1	5.3
		20	0.20	0.25	0.31	0.47	0.70	1.1	1.6	2.5	3.8	5.4	7.2
32	1 1/4	25	0.35	0.38	0.65	1.00	1.5	2.2	3.4	5.1	7.0	9.4	12.0
		20	0.22	0.25	0.35	0.50	0.75	1.1	1.6	2.5	3.8	5.8	8.0
		25	0.40	0.47	0.73	1.1	1.6	2.5	3.7	5.4	7.5	10.3	13.0
		32	0.48	0.60	0.85	1.3	2.1	3.1	4.5	6.8	10.2	14.0	17.8

Table 24: Kv values, DN10 to DN32, globe control valves



DN connection (valve body)		Seat size valve	Kv values [m <sup>3</sup> /h]										
			Stroke [%]										
DN	[NPS]		5	10	20	30	40	50	60	70	80	90	100
40	1 1/2	25	0.40	0.50	0.75	1.1	1.7	2.6	3.8	5.6	8.0	10.7	13.6
		32	0.48	0.60	0.85	1.3	2.1	3.2	4.6	6.9	11.0	15.0	20.0
		40	0.60	0.70	1.1	1.7	2.7	4.0	6.0	9.2	13.8	18.2	24.0
50	2	32	0.48	0.60	0.90	1.3	2.1	3.2	4.6	6.9	11.6	16.0	21.0
		40	0.60	0.70	1.00	1.7	2.6	4.0	5.9	9.2	14.0	18.9	24.5
		50	0.90	1.1	1.9	2.9	4.5	6.8	10.5	15.5	22.0	29.0	37.0
65	2 1/2	40	0.45	0.55	0.85	1.3	2	3.1	4.6	6.8	10.7	17,2	25.5
		50	0.75	0.9	1.5	2.3	3.5	4.9	7.1	11	17.5	26	39.5
		65	1.1	1.4	2.1	3.2	4.9	8	12	18.5	31.5	46.5	62
80	3	50	0.85	1	1.5	2.3	3.5	5	7.1	10.5	16	25	42
		65	1.4	1.7	2.5	3.8	5.7	8.2	12.2	19.5	32,5	50	70
		80	2.1	2.6	4.2	7	10.5	16	25	40	60	83	100
100	4	65	1.4	1.7	2.6	3.8	5.7	8.3	12.6	20	32	51	75
		80	2.1	2.6	4.3	7	11	17	26,5	44	65	89	115
		100	3.2	3.9	5.7	9	13.5	20.5	32	51	83	118	140

Table 25: Kv values, DN40 to DN100, globe control valves

## 9 INSTALLING THE VALVE

### 9.1 Safety instructions



#### WARNING!

Risk of injury due to improper installation.

- ▶ Installation may be carried out by trained technicians only with the appropriate tools.
- ▶ Secure the system against unintentional activation.
- ▶ After installation, ensure that the process is restarted in a controlled manner. Observe the sequence!
  1. Connect supply voltage.
  2. Charge the device with medium.



#### CAUTION!

Risk of injury due to heavy device.

During transportation or installation work, the device may fall down and cause injuries.

- ▶ Transport, install and remove heavy device with the aid of a second person only.
- ▶ Use suitable tools.

#### NOTE!

**Loose screw connection of the valve body connection with high mechanical stress.**

If the pipeline is subject to high mechanical stress (vibrations), the screw connection on the valve body connection must be checked before installation and regularly during operation (tightening torque see ["Table 26" on page 57](#)).

### 9.2 Installation of devices with threaded connection, flange connection or clamp connection

#### NOTE!

**Damage to valve body, valve seat seal or diaphragm.**

- ▶ To prevent damage, the device must be in MANUAL operating state during installation.

Devices in their factory default state already have their operating state set to MANUAL.

#### 9.2.1 Required work steps

1. If not already preset, set MANUAL operating state, chapter ["14.1" on page 102](#).
2. If the device is already electrically connected, shut off supply voltage. Wait until LED illuminated ring goes out.
3. Install device in pipeline, chapter ["9.2.3" on page 51](#).
4. Electrical installation, chapter ["10" on page 60](#).
5. Connect supply voltage.
6. Set AUTOMATIC mode, chapter ["14.1" on page 102](#).

## 9.2.2 Mounting conditions

Installation position:	arbitrary, ideally with actuator facing upwards.
Flow direction:	indicated on the type label with an arrow and the digits 1 and 2. The 1 and 2 are also on the valve body for identification. The flow direction is below the seat with flow from port 2 to port 1.
Pipelines:	ensure that pipelines are in alignment.
Filter:	required for devices with approval as per EN 161. According to EN 161 “Automatic shut-off valves for gas burners and gas appliances”, a dirt trap, which prevents the penetration of a 1 mm test pin, must be installed upstream of the valve in the pipeline.
Preparation:	Clear impurities from pipelines (seal material, metal chips, etc.).

## 9.2.3 Install device in the pipeline

Prerequisite: MANUAL operating state.

### NOTE!

The following must be heeded when installing the device in the system.

The device and relief bore must be accessible for inspections and maintenance work.



### DANGER!

Risk of injury from high pressure.

- ▶ Before working on the system, switch off the pressure and vent or empty the lines.



### WARNING!

Risk of crushing by mechanically powered parts.

- ▶ Do not reach into the openings of the valve body.

→ Connect valve body to pipeline.



Ensure that there is no voltage present and minimal vibration during installation.



### Holding device

To protect the valve actuator from damage resulting from forces and vibrations, a holding device is recommended. This is available as an accessory. See chapter [“24 Accessories, Wearing parts”](#).

### Next steps:

- Electrical installation, chapter [“10”](#) on page 60.
- Connect supply voltage.
- Set AUTOMATIC mode, chapter [“14.1”](#) on page 102.

## 9.3 Installation of devices with welded connections

### NOTE!

Damage to valve body, valve seat seal or diaphragm.

- ▶ To avoid damage, the valve should only be mounted in the opened valve position and in the MANUAL operating state.

Devices in their factory default state already have their operating state set to MANUAL.

### NOTE!

The following must be heeded when installing the device in the system.

The device and relief bore must be accessible for inspections and maintenance work.

### 9.3.1 Required work steps

The device must not be welded into the pipeline while the actuator is still installed. The installation is divided into the following steps:

1. If not already preset, set MANUAL operating state, chapter [“14.1” on page 102](#).
2. If the valve is in the closed position, switch the valve to the open position, chapter [“15” on page 113](#).
3. If the device is already electrically connected, shut off supply voltage. Wait until LED illuminated ring goes out.
4. Remove actuator from the valve body, chapter [“9.4” on page 54](#).
5. Weld the valve body into the pipeline, chapter [“9.3.4” on page 53](#).
6. Mount actuator on the valve body, chapter [“9.5” on page 56](#).
7. Electrical connection of the device, chapter [“10” on page 60](#).
8. Connect supply voltage.
9. To adjust the position control, execute the X.TUNE function, chapter [“11.6” on page 76](#).
10. Set AUTOMATIC mode, chapter [“14.1” on page 102](#).

### 9.3.2 Required tool

- Allen key, width across flats 3 mm (AG2) / 5 mm (AG3)  
Required when no supply voltage is applied to the device in order to move the valve into the open position.
- Open-end wrench

### 9.3.3 Mounting conditions

Installation position: any

Flow direction: indicated on the type label with an arrow and the digits 1 and 2.  
The 1 and 2 are also on the valve body for identification.  
The flow direction is below the seat with flow from port 2 to port 1.

Pipelines: ensure that pipelines are in alignment.

- Filter:** required for devices with approval as per EN 161.  
According to EN 161 “Automatic shut-off valves for gas burners and gas appliances”, a dirt trap, which prevents the penetration of a 1 mm test pin, must be installed upstream of the valve in the pipeline.
- Preparation:** Clear impurities from pipelines (seal material, metal chips, etc.).

### 9.3.4 Weld the valve body into the pipeline



#### **DANGER!**

Risk of injury from high pressure.

- ▶ Before working on the system, switch off the pressure and vent or empty the lines.

#### **NOTE!**

The electronics assembly in the actuator will be damaged by the effects of heat.

- The actuator must be removed before the valve body is welded in.

→ Weld the valve body into the pipeline.



Ensure that there is no voltage present and minimal vibration during installation.



#### **Holding device**

To protect the valve actuator from damage resulting from forces and vibrations, a holding device is recommended. This is available as an accessory. See chapter “[24 Accessories, Wearing parts](#)”.

#### **Next steps:**

- Mount actuator on the valve body, chapter “[9.5](#)” on page 56.
- Electrical connection of the device, chapter “[10](#)” on page 60.
- Connect supply voltage.
- To adjust the position control, execute the X.TUNE function, chapter “[11.6](#)” on page 76.

#### **NOTE!**

**Damage to valve body, valve seat seal or diaphragm.**

- ▶ To avoid damage, execute the X.TUNE function first after establishing the electrical connection. Only then should the operating state be set to AUTOMATIC.

- Set AUTOMATIC mode, chapter “[14.1](#)” on page 102.

## 9.4 Disassembly of the actuator from the valve body



### DANGER!

Risk of injury from high pressure.

- ▶ Before working on the system or device, switch off the pressure and vent or empty the lines.



### WARNING!

Risk of injury due to improper installation work.

- ▶ The actuator may be removed only by trained technicians and with the appropriate tools.

### 9.4.1 Required work steps

1. Set MANUAL operating state, chapter “14.1” on page 102.
2. Move valve into open position, chapter “15” on page 113.
3. Switch off the supply voltage. Wait until LED illuminated ring goes out.
4. Remove actuator from the valve body, chapter “9.4.3” on page 54.

### 9.4.2 Required tool

- Allen key, width across flats 3 mm (AG2) / 5 mm (AG3)  
Only required when no supply voltage is applied to the device in order to move the valve into the open position.
- Open-end wrench

### 9.4.3 Removing actuator from the valve body

Prerequisites:

MANUAL operating state, valve position at least 1/3 open, supply voltage switched off.



### WARNING!

Risk of injury due to electric shock.

Risk of crushing by mechanically powered parts.

- ▶ Switch off the supply voltage.
- ▶ For devices with SAFEPOS energy-pack: completely remove the SAFEPOS energy-pack. Wait until the LED ring is no longer lit and ensure that the LED status indicator is not in “LED off” mode.

### NOTE!

Damage to valve body or valve seat seal.

To avoid damage, the valve must be open when the actuator is disassembled.

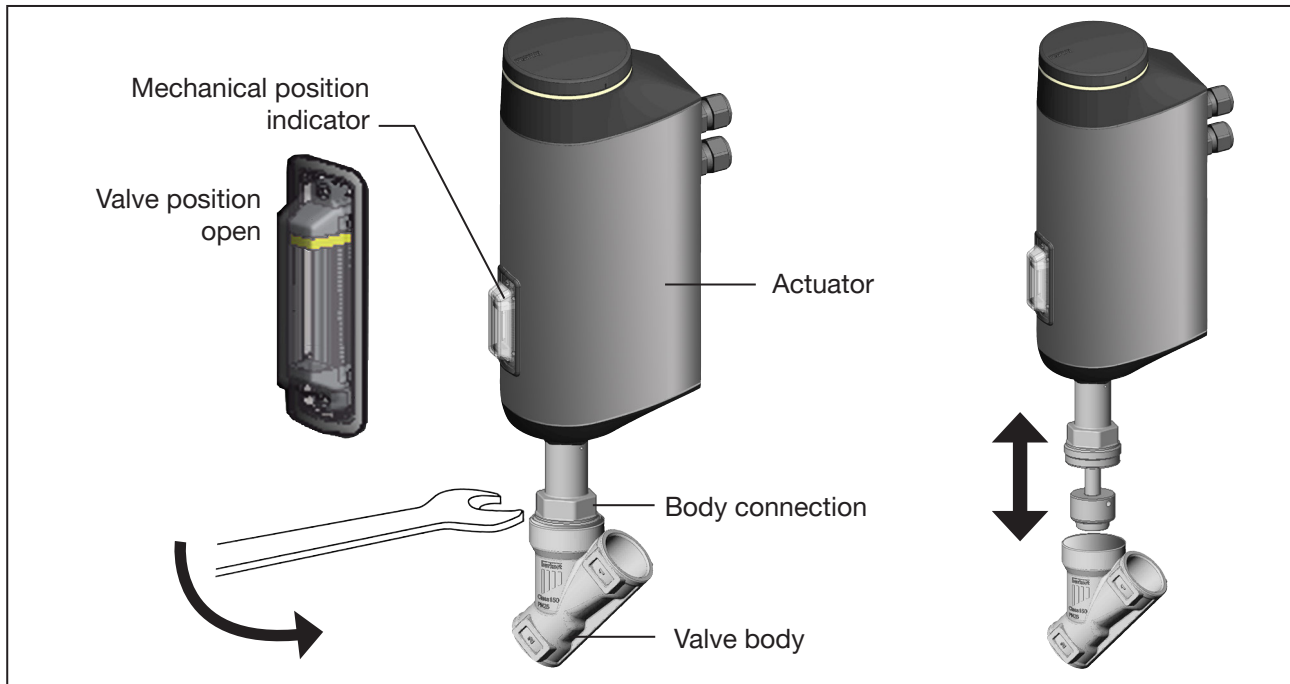

Fig. 21: Actuator disassembly (with angle seat control valve as an example)

- Clamp valve body into a holding device.
- Place on the body connection with a suitable open-end wrench.  
⚠ Do not use any tools for unscrewing which could damage the body connection.
- Unscrew actuator from the valve body.

## 9.5 Installing actuator on valve body

Prerequisites:

MANUAL operating state, valve position at least 1/3 open, supply voltage switched off.

→ ⚠ Before installing the actuator, check whether the seal for the valve body is present and undamaged.

→ Replace seal.

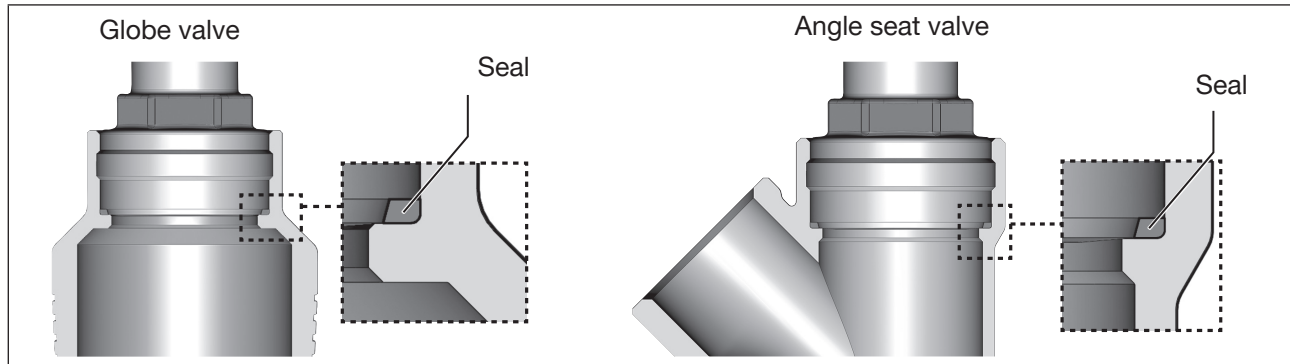

Fig. 22: Seal

### NOTE!

Damage to valve body or valve seat seal.

To avoid damage, the valve must be in an open position when the actuator is disassembled.



### WARNING!

Danger due to unsuitable lubricants.

Unsuitable lubricant may contaminate the medium. There is a risk of explosion in oxygen applications.

► For specific applications, e.g. oxygen or analysis applications, use approved lubricants only.

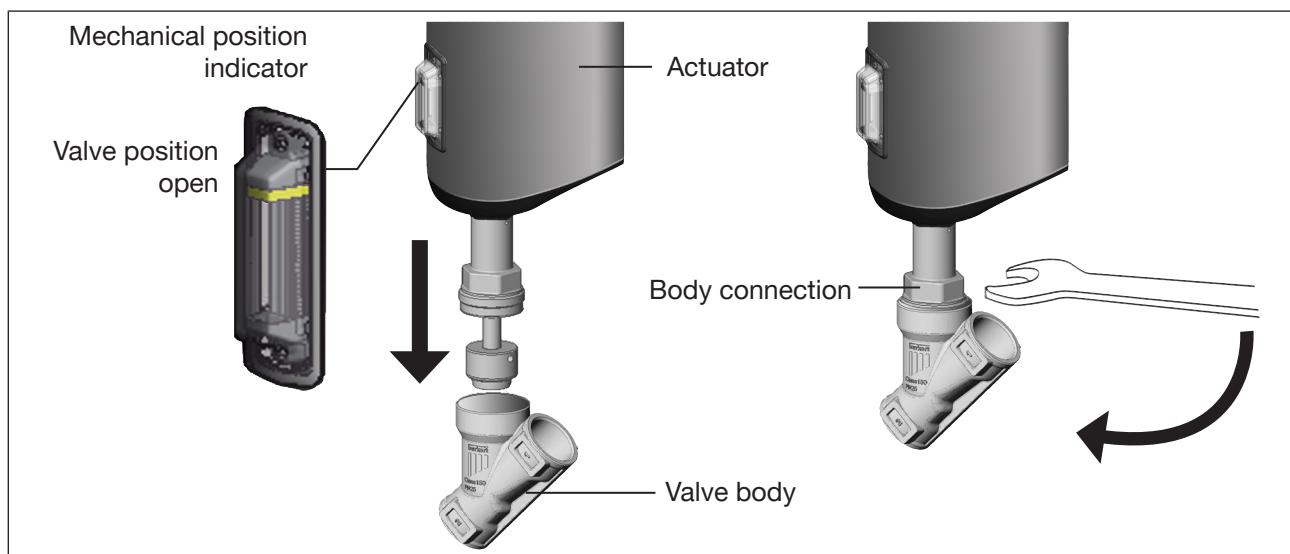

Fig. 23: Installing actuator on valve body

→ Before re-installation, grease the external thread of the body connection (e.g. with Klüberpaste UH1 96-402 from Klüber).



→ Position the external thread of the valve body on the internal thread of the body connection.

→ Place on the body connection with a suitable open-end wrench.

⚠ Do not use any tools for unscrewing, which could damage the body connection.



### WARNING!

**Risk of injury when failing to observe tightening torque value!**

Failure to observe the tightening torque value is dangerous due to the risk of damage to the device.

▶ Observe the tightening torque value.

→ Screw actuator onto valve body.

⚠ Observe tightening torque (see “Table 26”).

DN connection (valve body) [DN]	Tightening torque for body connection [Nm]
10/15	45 ±3
20	50 ±3
25	60 ±3
32	65 ±3
40	
50	70 ±3
65	100 ±3
80	120 ±5
100	150 ±5

Table 26: Tightening torque for body connection

#### Next steps:

- Electrical connection of the device, chapter “10” on page 60.  
The position of the ports can be changed by turning the actuator through 360°. For a description see chapter “9.6 Rotating the actuator”.
- Connect supply voltage.
- To adjust the position control, execute the X.TUNE function, chapter “11.6” on page 76.

#### NOTE!

**Damage to valve body, valve seat seal or diaphragm.**

▶ To avoid damage, execute the X.TUNE function first after establishing the electrical connection. Only then should the operating state be set to AUTOMATIC.

- Set AUTOMATIC mode, chapter “14.1” on page 102.

## 9.6 Rotating the actuator

The position of the ports can be changed by turning the actuator through 360°.

### NOTE!

**Damage to the valve seat seal and valve seat contour when valve closed.**

If the valve is closed when the actuator is turned, the valve seat seal and the valve seat contour can be damaged.

- If the valve is closed: before turning the actuator, open the valve with the mechanical manual override. For a description see [“15.4 Actuating the valve mechanically”](#).

→ For devices that have not been installed, clamp the valve body in a holding device.

→ Place a suitable open-end wrench (width across flats M41) on the hexagon head of the actuator.

→ Move the actuator into the desired position preferably by turning it clockwise.

If only turning counterclockwise is technically possible for installation, observe the following safety warning:



### WARNING!

**Risk of injury from discharge of pressure and escaping medium.**

If the actuator is turned counterclockwise, the body connection can loosen.

- ▶ When turning counterclockwise, hold the hexagon of the body connection with a 2nd open-ended wrench.

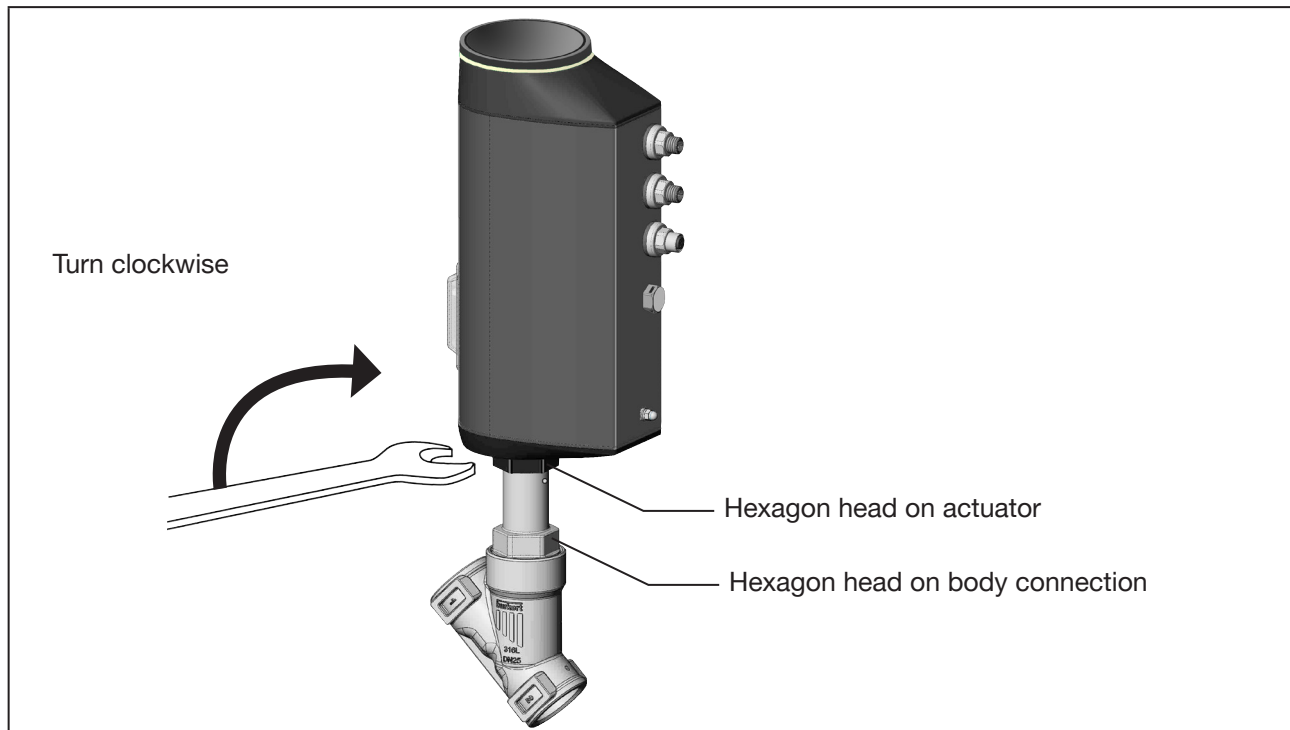

Fig. 24: Turn actuator

## 9.7 Holding device

The holding device protects the valve actuator from damage resulting from forces and vibrations. The holding device is available as an accessory in 2 sizes. See chapter “[24 Accessories, Wearing parts](#)” on page 161.

### 9.7.1 Mounting the holding device

→ Attach the holding device to the pipe between the valve body and the actuator as shown in the picture.

In case of existing relief bore:

#### **NOTE!**

Make sure that the relief bore, which is used to detect leaks, is not covered.

→ Fix the holding device in place by suitable means.

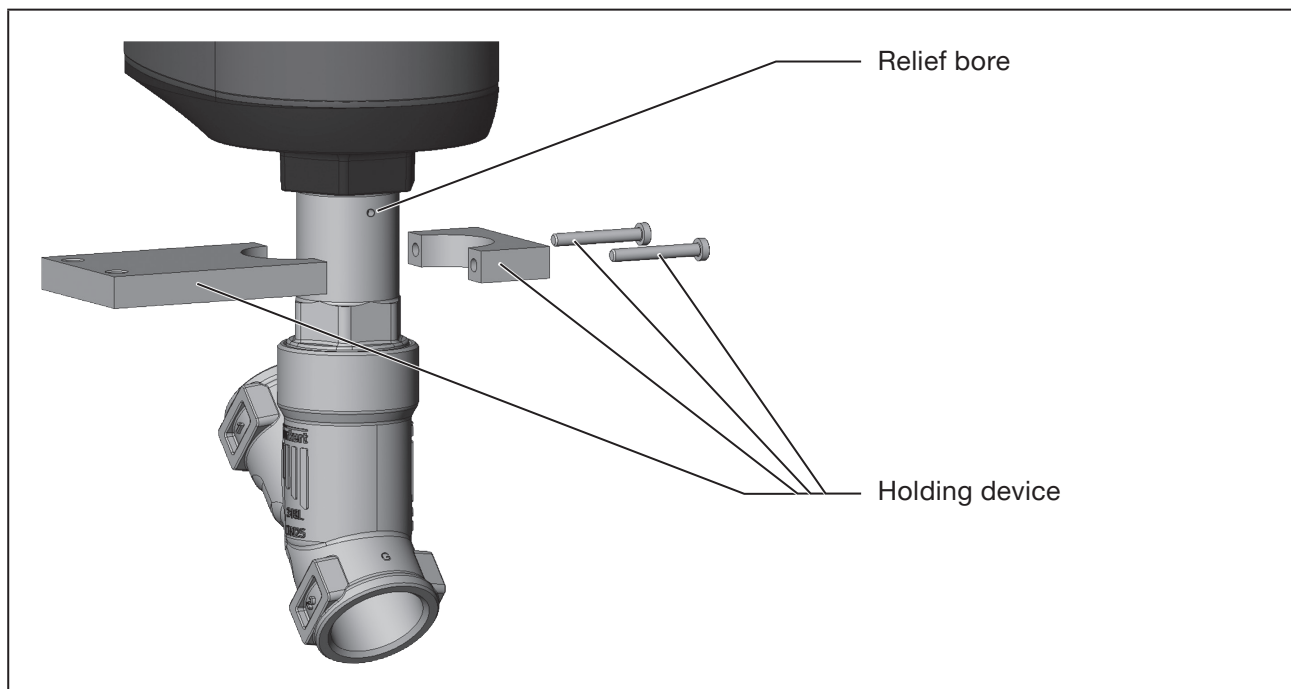



Fig. 25: Mounting the holding device

## 10 ELECTRICAL INSTALLATION

The electromotive control valve is available with two connector options:

- With a circular plug-in connector (multi-pin variant)
- Cable gland with connection terminals (only AG2)

### Signal values

Operating voltage: 24 V 

Set-point value: 0–20 mA; 4–20 mA  
0–5 V; 0–10 V

### 10.1 Electrical installation with circular plug-in connector

#### 10.1.1 Safety instructions



#### WARNING!

**Risk of injury due to improper installation.**

- ▶ Installation may be carried out by authorised technicians only and with the appropriate tools.
- ▶ Observe general engineering standards & rules during installation.

**Risk of injury due to unintentional activation of the system and uncontrolled restart.**

- ▶ Secure the system against unintentional activation.
- ▶ Following installation, ensure a controlled restart.

#### NOTE!

To ensure electromagnetic compatibility (EMC) the functional earth must be connected to earth with a short line (max. 1 m). Functional earth must have a cross-section of at least 1.5 mm<sup>2</sup>.



#### Use of set-point input 4–20 mA

If several Type 3360 or 3361 devices are connected in series and the electrical power supply for a device in this connected series fails, the input of the failed device becomes highly resistive. As a result, the 4–20 mA standard signal fails.

#### Choice of connection line:

When choosing the length and cross-section of the individual wires, take into account the voltage drop in relation to the maximum supply current.

→ Connect the device in accordance with the tables.

→ Perform the necessary basic configuration and adjustments for the electromotive control valve after the operating voltage has been established. For a description see chapter [“11 Start-up”](#).

## 10.1.2 Description of circular plug-in connectors AG2 and AG3

### AG2 variant

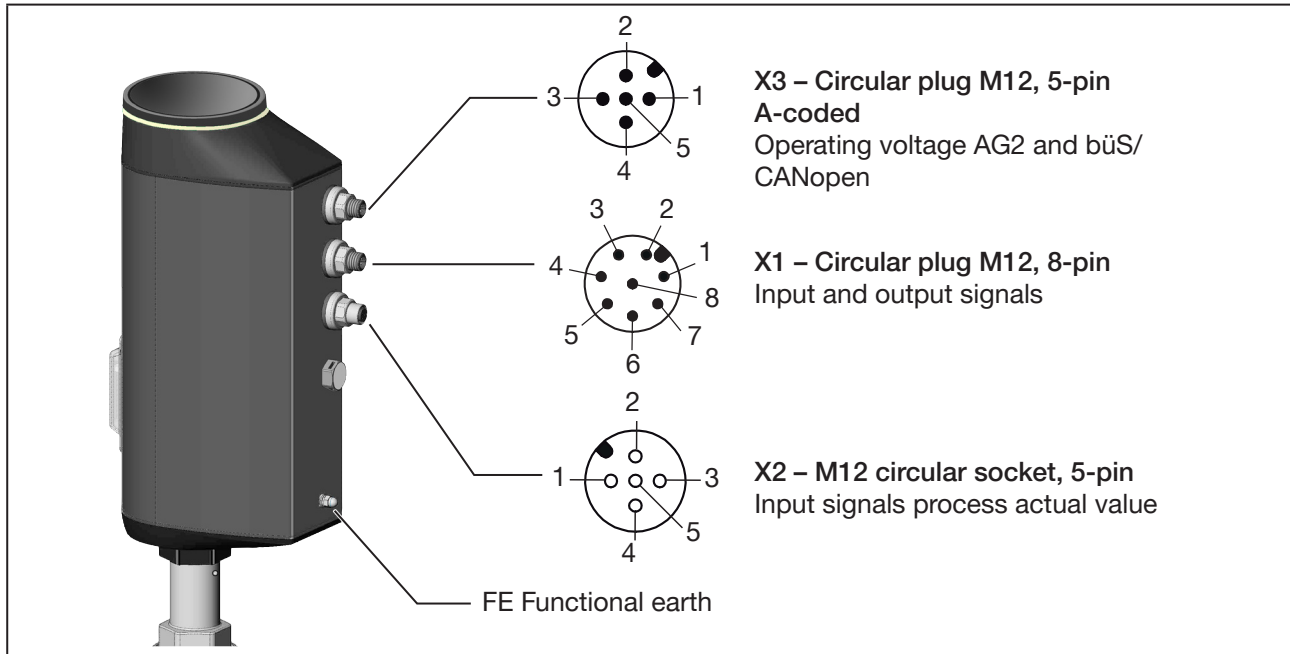

Fig. 26: Description of circular plug-in connector AG2

### AG3 variant

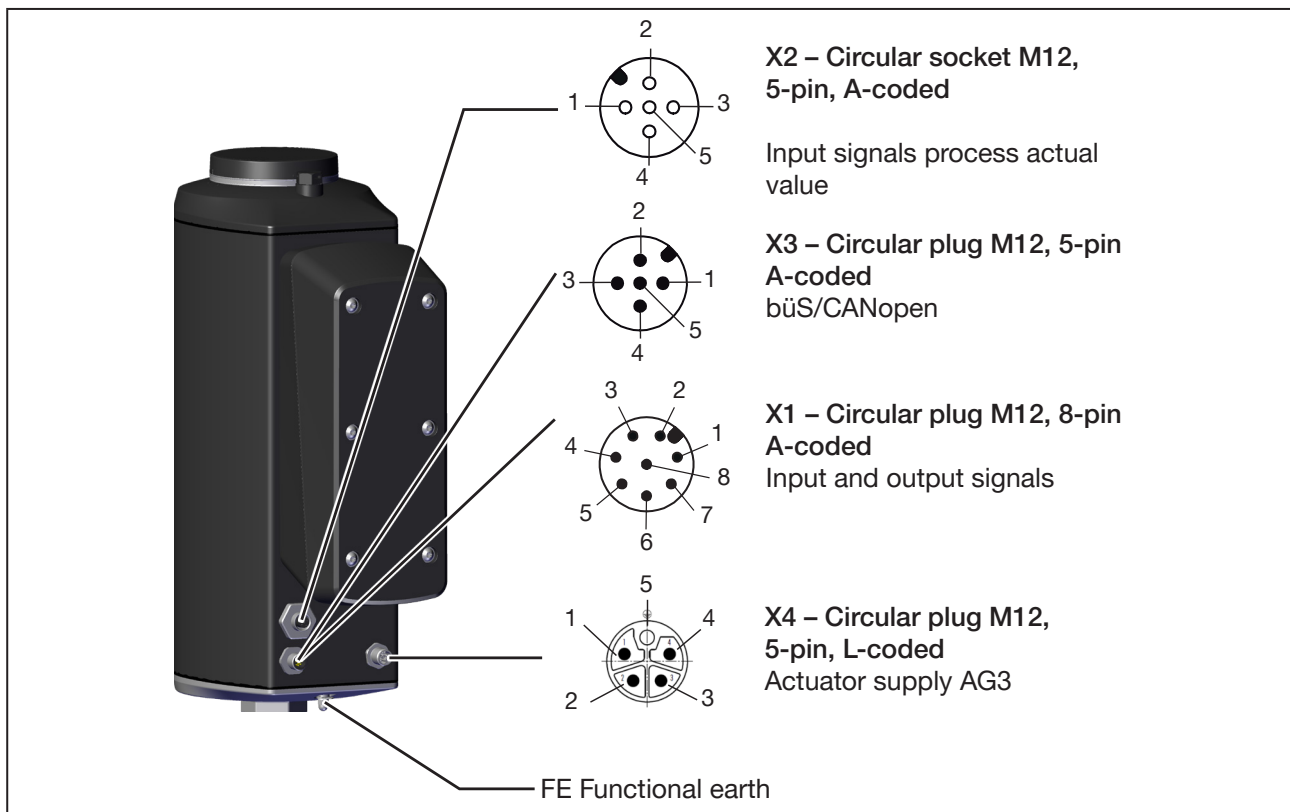

Fig. 27: Description of circular plug-in connector AG3

Circular plug-in connector	AG2			AG3		
	Analogue	Fieldbus gateway	büS/ CANopen	Analogue	Fieldbus gateway	büS/ CANopen
X1	X	-	-	X	-	-
X2	Optional for devices with process control function					
X3	X	X	X	-	X	X
X4	-	-	-	X	X	X

Table 27: Use of circular plug-in connector AG2/AG3

→ Connect the device in accordance with the tables.

→ Perform the necessary basic configuration and adjustments for the electromotive valve after the operating voltage has been established. see chapter “11 Start-up”

### 10.1.3 X1 – Circular plug M12, 8-pin A-coded Input and output signals

Pin	Wire colour*	Assignment
<b>Input signals from control centre (e.g. PLC)</b>		
8	red	Set-point value + (0/4–20 mA or 0–5/10 V) for operating voltage electrically isolated
7	blue	Set-point value –
1	white	Digital input + 
<b>Output signals to control centre (e.g. PLC) only required with analogue output and/or digital output option</b>		
6	pink	Analogue output+ (0/4–20 mA or 0–5/10 V)
5	grey	Analogue output –
4	yellow	Digital output 1 (24 V / 0 V)
3	green	Digital output 2 (24 V / 0 V)
2	brown	Digital inputs and digital outputs GND
* The specified wire colours refer to the connection cable, which is available as an accessory with ID no. 919061.		

Table 28: X1 – Circular plug M12, 8-pin

### 10.1.4 X2 – M12 circular socket, 5-pin, A-coded input signals process actual value (only with process control function)

Signal type*	Pin	Wire colour	Assignment	Device end	External circuit
4–20 mA – internally supplied	1 2 3 4 5	brown white blue black grey	+24 V supply transmitter PV1: not used GND (identical to GND operating voltage) PV2: output from transmitter PV3: Bridge to GND (GND from 3-wire transmitter)	1 2 3 4 5	
4...20 mA - externally supplied	1 2 3 4 5	brown white blue black grey	not used not used not used PV2: process actual + PV3: process actual –	4 5	4...20 mA GND 4...20 mA
Frequency – internally supplied	1 2 3 4 5	brown white blue black grey	+24 V supply sensor PV1: Cycle input + GND PV2: not used PV3: Bridge to GND (GND from 3-wire transmitter)	1 2 3 5	+24 V Cycle + GND (identical to GND operating voltage) Cycle –
Frequency - externally supplied	1 2 3 4 5	brown white blue black grey	not used PV1: Cycle input + not used PV2: not used PV3: Cycle input –	2 5	Cycle + Cycle –
Pt 100 (see note below)	1 2 3 4 5	brown white blue black grey	not used PV1: Process actual 1 (power supply) not used PV2: Process actual 2 (compensation) PV3: Process actual 3 GND	2 4 5	
* Configurable in the software: <b>Inputs/outputs</b> → PV → ANALOG.type (Signal source: PV.source → Analog).					

Table 29: X2 – M12 socket, 5-pin, input signals process actual value (only on devices with process control function)

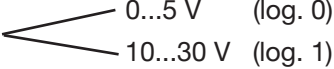

#### NOTE!

The Pt 100 sensor must be connected via three lines to compensate for line resistance. Pin 4 and Pin 5 must be bridged at the sensor. Connection cables must not exceed 20 m in length.

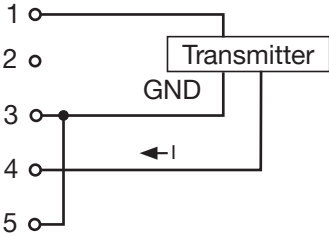
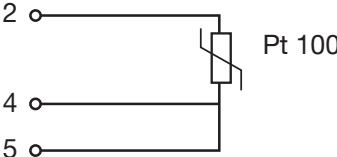
### 10.1.5 X3 – Circular plug M12, 5-pin A-coded, operating voltage AG2 and büS/CANopen network



**Electrical installation with or without büS-network:**

In order to be able to use the büS network (CAN interface), a 5-pin circular plug and a shielded 5-wire cable must be used.

If the büS network is not used, a 4-pin circular plug can be used as a counterpart.

Pin	Wire colour		Layout (from device perspective)
	without büS network 4-pin connection*	with büS network**	
1	-	CAN shield/shielding	
2	white	red	+24 V $\pm 10\%$ , max. ripple 10%
3	blue	black	GND /CAN_GND
4	-	white	CAN_H
5	-	blue	CAN_L

\* The specified wire colours relate to the 4-pin M12 connection cable, which is available as an accessory with ID No. 918038.  
 \*\* The specified wire colours relate to the büS cable, which is available as an accessory. See cabling guideline on our website [country.burkert.com](http://country.burkert.com).

Table 30: X3 – Circular plug M12, 5-pin, A-coded, operating voltage AG2 and büS/CANopen network

### 10.1.6 X3 – Circular plug M12, 5-pin, büS/CANopen network AG3



For variants with fieldbus gateway, using this connection is optional for service büS or a büS-capable externally supplied sensor.

Pin	Wire colour with büS network*	Layout (from device perspective)
1	CAN shield/shielding	
2**	red	24 V $\pm 10\%$ max. ripple 10%
3**	black	GND / CAN_GND
4	white	CAN_H
5	blue	CAN_L

\*The specified wire colours relate to the büS cable, which is available as an accessory. See cabling guideline on our website [country.burkert.com](http://country.burkert.com).  
 \*\* This system supply must be galvanically isolated from the actuator supply.

Fig. 28: X3 – Circular plug M12, 5-pin, büS/CANopen network AG3



### 10.1.7 X4 – Circular plug M12, L-coded, 5-pin, actuator supply AG3

Pin	Wire colour*	Assignment
1	brown	24 V $\pm 10\%$ , max. residual ripple 10%
2	white	Do not connect
3	blue	GND
4	black	Do not connect
5	grey	FE connected to housing

\* The specified wire colours relate to the 5-pin M12 connection cable, which is available as an accessory with ID No. 20010840.

Table 31: X4 – Circular plug M12, L-coded, actuator supply AG3

## 10.2 Electrical connection fieldbus gateway

The fieldbus gateway for Industrial Ethernet is connected using 4-pin M12 circular plug-in connectors.

### NOTE!

To ensure electromagnetic compatibility (EMC), a shielded Ethernet cable must be used. Connect the cable shielding on both sides to earth (i.e. on each of the connected devices).

Use a short line (max. 1 m) with a cross-section of at least 1.5 mm<sup>2</sup> for connecting to earth.

For the version with fieldbus gateway, the fieldbus gateway must also be grounded in addition to the grounding on the actuator. This earthing is done with the enclosed earthing terminal on the circular plug-in connector of the connected Ethernet cable.

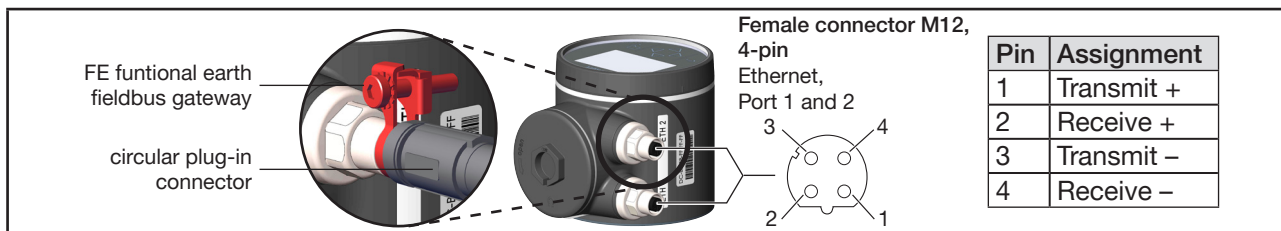

Fig. 29: Electrical connection, layout and FE functional earth on fieldbus gateway

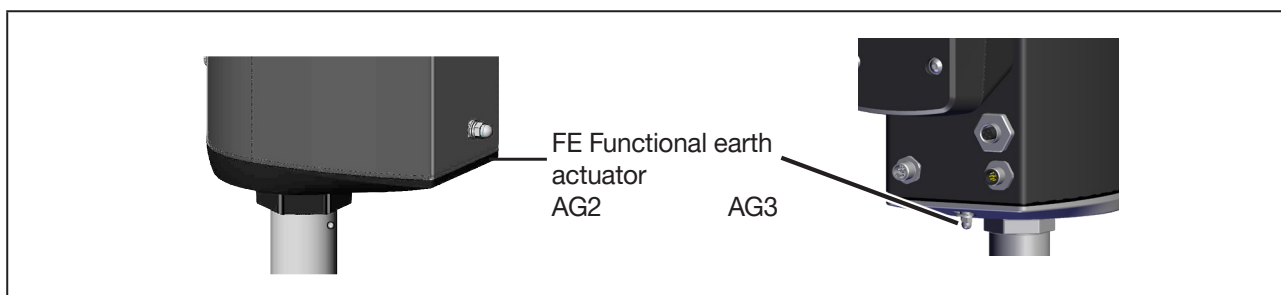

Fig. 30: FE functional earth on actuator

## 10.3 Electrical installation with cable gland (only AG2)

### 10.3.1 Safety instructions



#### WARNING!

Risk of injury due to improper installation.

- ▶ Installation may be carried out by authorised technicians only and with the appropriate tools.
- ▶ Observe general engineering standards & rules during installation.

Risk of injury due to unintentional activation of the system and uncontrolled restart.

- ▶ Secure the system against unintentional activation.
- ▶ Following installation, ensure a controlled restart.



#### Use of set-point input 4–20 mA

If several Type 3360 or 3361 devices are connected in series and the electrical power supply for a device in this connected series fails, the input of the failed device becomes highly resistive. As a result, the 4–20 mA standard signal fails.

#### NOTE!

To ensure electromagnetic compatibility (EMC) the functional earth must be connected to earth with a short line (max. 1 m). Functional earth must have a cross-section of at least 1.5 mm<sup>2</sup>.

### 10.3.2 Access to connection terminals



Devices with ATEX approval or IECEx approval are secured with a magnetic lock.

The removal of the cover is described in the supplementary instructions for the electromotive control valves with ATEX approval and IECEx approval.

To access the terminals, open the actuator housing as described below.

1. Remove display module or blind cover:

#### NOTE!

Carefully remove the display module so that the connection cable and HMI interface are not damaged.



Fig. 31: Remove blind cover or display module

- To unlock, turn the display module or the blind cover counterclockwise and remove.
- NOTE!** For devices with display module, take note of the connection cable to the HMI interface.
- For devices with display module, disconnect the connection cable from the HMI interface.

## 2. Remove the LED and storage module:

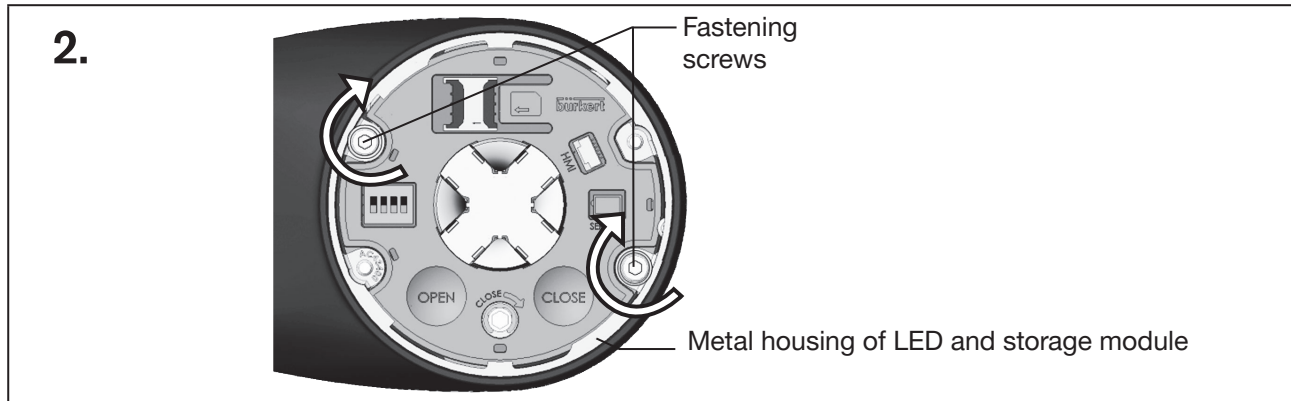

Fig. 32: Remove the LED and storage module

- Remove 2 fastening screws (hexalobular-internal screws T20).
- Grab the LED and storage module by both sides of the metal housing and lift it out.

## 3. Remove the actuator cover:

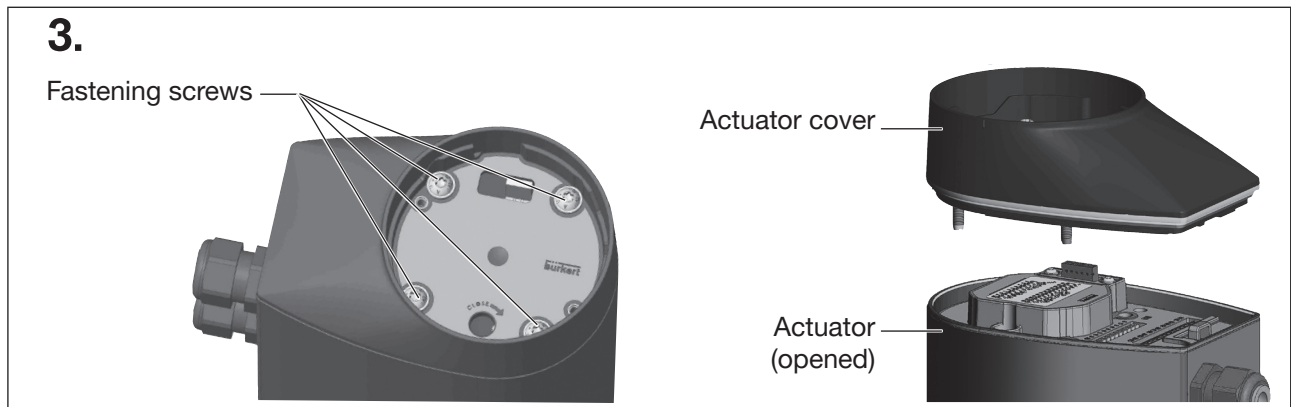

Fig. 33: Removing actuator cover

- Remove 4 fastening screws (hexalobular-internal screws T25).  
The screws are integrated securely in the actuator cover.
- Remove the actuator cover.

The connection terminals are now accessible.

### 10.3.3 Connecting the cable

→ Push the cable through the cable gland.

**NOTE!**

Take note for connection to spring-loaded terminals.

- ▶ Minimum length of wire ferrules: 8 mm
- ▶ Maximum cross-section of the wire ferrule: 1.5 mm<sup>2</sup> (without collar), 0.75 mm<sup>2</sup> (with collar)

→ Strip at least 8 mm of insulation from the wires and crimp ferrules on.

→ Attach the wires to the terminals. The terminal layout is provided in the tables below from [page 69](#).

→ Tighten union nut of cable gland (tightening torque approx. 1.5 Nm).

**NOTE!**

The ingress of dirt or moisture may cause damage or malfunction.

To preserve IP65 and IP67 protection, ensure the following:

- ▶ Unused cable glands must be sealed using dummy plugs.
- ▶ The union nuts of cable glands must be tightened. Tightening torque, dependent on the cable size or dummy plugs, approx. 1.5 Nm.

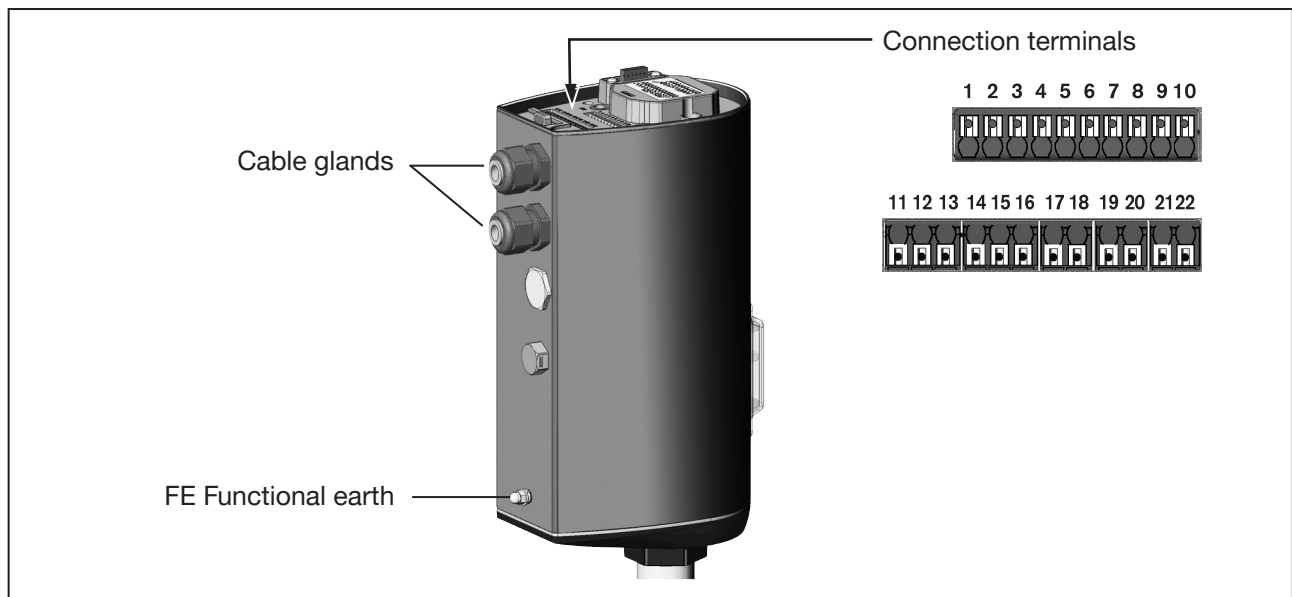

Fig. 34: Connecting the cable

→ Connect the device in accordance with the tables.

MAN 1000274112 EN Version: H Status: RL (released | freigegeben) printed: 26.01.2023

### 10.3.4 Terminal layout – input signal from control centre (e.g. PLC)

Clip	Assignment
8	Set-point value + (0/4–20 mA or 0–5/10 V) for operating voltage electrically isolated
7	Set-point value –
5	Digital input + 
4	Digital input GND relates to GND operating voltage (GND Clip)

Table 32: Terminal layout – input signal from control centre (e.g. PLC)

### 10.3.5 Terminal layout – output signals to control centre (e.g. PLC) – only required with analogue output and/or digital output option

Clip	Assignment
19	Analogue output + (0/4–20 mA or 0–5/10 V)
20	Analogue output –
18	Digital output 1 (24 V / 0 V)
17	Digital output 2 (24 V / 0 V)
16	Digital output GND

Table 33: Terminal layout – output signal to control centre (e.g. PLC)

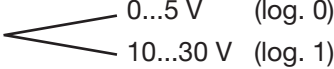
### 10.3.6 Terminal layout – operating voltage and bÜS network



Clip	Assignment
	CAN shield/shielding
10	24 V  ± 10% max. ripple 10%
9	GND
1*	CAN_GND  Only connect when a separate line is used for CAN.
2*	CAN_H
3*	CAN_L

Table 34: Terminal layout – operating voltage and bÜS network



\*Electrical installation of bÜS network:

Terminals 1, 2 and 3 (CAN interface) are for the bÜS network connection.

Terminal 1 is bridged internally with terminal 9, however it is not designed for the operating voltage.

### 10.3.7 Terminal layout – process actual value input (only with process control function)

Signal type*	Clip	Assignment	Device end	External circuit
4...20 mA – internally supplied	22 15 21 14 13	+24 V supply transmitter PV1: not used GND (identical to GND operating voltage) PV2: output from transmitter PV3: Bridge to GND (GND from 3-wire transmitter)	22 15 21 14 13	
4...20 mA - externally supplied	22 15 21 14 13	not used not used not used PV2: process actual + PV3: process actual -	14 13	14 — 4...20 mA 13 — GND 4...20 mA
Frequency – internally supplied	22 15 21 14 13	+24 V supply sensor PV1: Cycle input + GND PV2: not used PV3: Bridge to GND (GND from 3-wire transmitter)	22 15 21 13	22 — +24 V 15 — Cycle + 21 — GND (identical to GND operating voltage) 13 — Cycle -
Frequency – externally supplied	22 15 21 14 13	not used PV1: Cycle input + not used PV2: not used PV3: Cycle input -	15 13	15 — Cycle + 13 — Cycle -
Pt 100 (see note below)	22 15 21 14 13	not used PV1: Process actual 1 (power supply) not used PV2: Process actual 2 (compensation) PV3: Process actual 3 GND	15 14 13	
* Configurable in the software: <b>Inputs/outputs</b> → PV → ANALOG.type (Signal source: PV.source → Analog).				

Table 35: Terminal layout – process actual value input (only on devices with process control function)



**NOTE!**

The Pt 100 sensor must be connected via three lines to compensate for line resistance. Clip 14 and clip 13 must be bridged at the sensor.

Connection cables must not exceed 20 m in length.

MAN 1000274112 EN Version: H Status: RL (released | freigegeben) printed: 26.01.2023

### 10.3.8 Close device

#### NOTE!

The ingress of dirt or moisture may cause damage or malfunction.

To preserve IP65 and IP67 protection, ensure the following before closing the device:

- ▶ The seal in the actuator housing/actuator cover must be inserted and undamaged.
- ▶ The seal surfaces must be clean and dry.

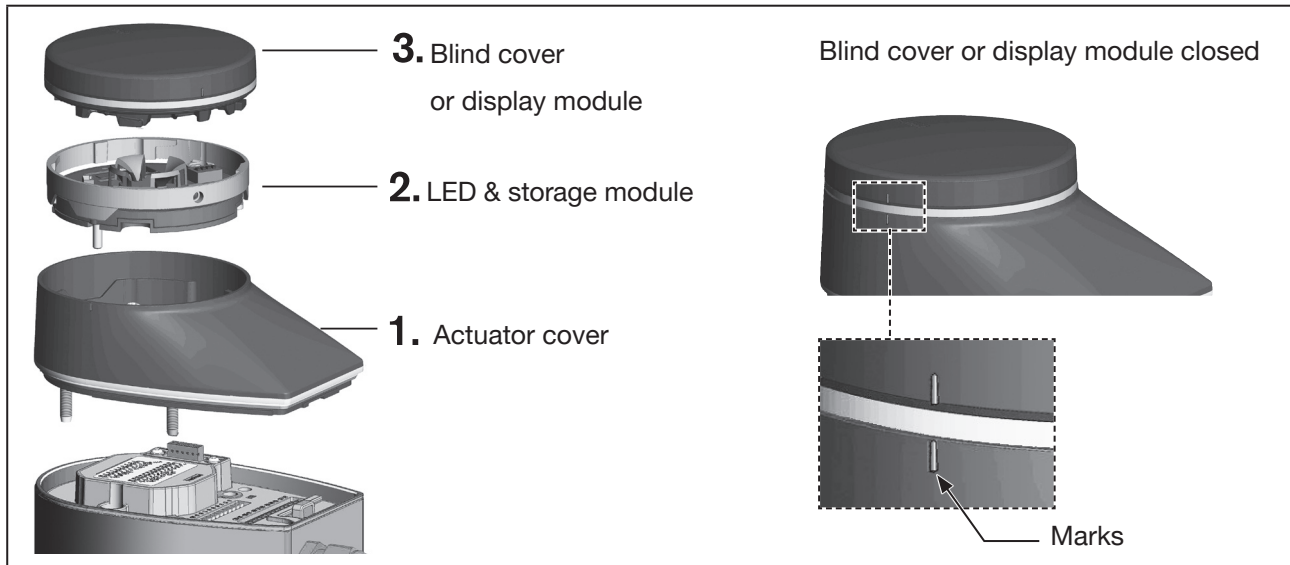

Fig. 35: Close device

#### 1. Install actuator cover

→ Place actuator cover on the actuator housing.

→ First screw in the four fastening screws (hexalobular-internal screws T25) by hand lightly, then tighten them (tightening torque: 5.0 Nm).

## 2. Mount LED and storage module:

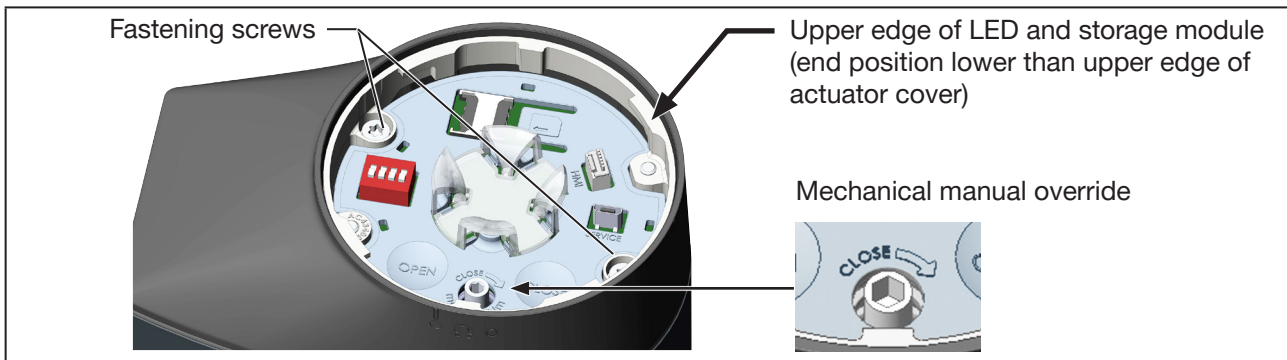

Fig. 36: Mount LED and storage module:

- Place the LED and storage module onto the actuator cover.  
Align the recess for the manual override in the centre, paying attention to the correct alignment of the electrical plug connection.
- Carefully press down the LED and storage module by hand.  
The end position is reached if the upper edge of the module is fully and evenly recessed in the actuator cover.

### NOTE!

The plug connection will be damaged if the LED and storage module is not correctly inserted.

- ▶ Before the fastening screws are tightened, the LED and storage module must be fully recessed in the actuator cover.

- Tighten 2 fastening screws (hexalobular-internal screws T20).  
Observe the tightening torque of 1.1 Nm!

## 3. Close device with blind cover or display module

For devices with display module:

- Connect the connection cable to the HMI interface.
- Fit the display module and turn clockwise until the marking at the edge is directly over the marking for the actuator cover.

For devices with blind covers:

Fit the blind cover and turn clockwise until the marking at the edge is directly over the marking for the actuator cover.

Perform the necessary basic configuration and adjustments for the electromotive control valve after the operating voltage has been established. For a description see chapter [“11.4 Base settings”](#).



# 11 START-UP

## 11.1 Safety instructions



### WARNING!

Risk of injury due to improper operation.

Improper operation may result in injuries as well as damage to the device and the surrounding area.

- ▶ The operating personnel must know and understand the contents of the operating instructions.
- ▶ The safety instructions and the intended use must be observed.
- ▶ Only adequately trained personnel may start up the system/device.

## 11.2 Before start-up

### NOTE!

Consider for devices requiring disassembly for installation.

If the actuator is disassembled, X.TUNE function must be carried out again before start-up. See chapter “11.6 Adjustment of position controller – execute X.TUNE”.

## 11.3 Configuration options for start-up

- **Configuration with the Bürkert Communicator software on PC**  
This type of configuration is possible for all device types and device variants.



The Bürkert Communicator software can be downloaded free of charge from the Bürkert website.

It requires the USB-büS-Interface set available as an accessory.  
Communication is performed via the device's büS service interface.

- **Configuration on display of device (optional)**  
Only possible on devices with display module.
- **Use two capacitive buttons in device to adjust position control (X.TUNE function)**  
Only possible on devices without display module.

## 11.4 Base settings



A start-up wizard that provides step-by-step guidance through the base settings is available for Bürkert Communicator and the display.  
(Configuration area → **Position controller** or **Process controller** → **START-UP**)

### 11.4.1 Base settings for position control



Before delivery, the base settings for the position control have already been input by the manufacturer. See diagrams below.

Type of base setting (observe sequence)		Factory default setting
1.	Set safety position	Close/open (dependent on device variant)
2.	Adjustment of position control (Function X.TUNE)	Factory setting <b>NOTE:</b> If the actuator is disassembled, X.TUNE function must be carried out again before start-up.
3.	Set standard signal for set-point position	Signal type analogue: 4–20 mA
		Gateway: Specified by fieldbus
4.	Set AUTOMATIC operating state	MANUAL

Table 36: Overview: base settings for position control

### 11.4.2 Base settings for process control



Before delivery, important base settings for the process control have already been input by the manufacturer. See diagrams below.

Type of base setting (observe sequence)		Factory default setting	
1.	Set safety position	Close/open (dependent on device variant)	
2.	Adjustment of position control (Function X.TUNE)	Factory setting <b>NOTE:</b> If the actuator is disassembled, X.TUNE function must be carried out again before start-up.	
3	Select physical unit for process control	Per cent	
4	Configure process values		
	a)	Select standard signal for process set-point value	Signal type analogue: 4–20 mA Gateway: Specified by fieldbus
	b)	Scale process set-point value	Minimum 0%, maximum 100%
	c)	Select standard signal for process actual value	4...20 mA
	d)	Scale process actual value	Minimum 0%, maximum 100%
5.	Scaling the process control	Minimum 0%, maximum 100%	
6.	Set dead band for process control	1 %	
7.	Set up process control		
	a)	Linearising process characteristic* (function P.LIN) Additionally for devices without display: Set DIP switch 2 to ON to activate the correction characteristic.	-
	b)	Adjust process control ** (P.TUNE function)	-
8.	Set AUTOMATIC operating state	MANUAL	

Table 37: Overview: base settings for position control

\* Only necessary if process characteristic varies substantially from linearity. Linearisation using the function P.LIN can take a lot of time with slow processes.

\*\*The P.TUNE function supports process control set-up by independently optimising process parameters. The process of fine-tuning process parameters is described in the Type 3360, 3361 software description.

## 11.5 Set safety position



### Setting option:

Using the Bürkert Communicator software or the display of the device (optional).

Settings are created on the PC using the büS service interface and the Bürkert Communicator software. It requires the USB büS interface set available as an accessory.

Display operation: button functions

 Select, activate	 Confirm	 Back
--	---	--

To adjust the safety position, switch to the “Parameters” detailed view for position controllers.

### How to switch to detailed view:

→ When using Bürkert Communicator for the configuration, select **Position Controller** in the navigation area.

→ When using the display for the configuration, switch to **CONFIGURATION** on the home screen and select **Position Controller**.

✔ You are now in the “Parameter” detailed view.

### How to configure the safety position:

→ Select **SAFEPOS**.

→ Select **FUNCTION**.

The following safety positions are available to choose from:

**Close** Valve tightly closed.

**Open** Valve open.

**User-defined** User-defined safety position.  
The entry of the position in this menu is described below.

**Inactive** Valve remains in an undefined position.

→ Set safety position.

**Entry of user-defined safety setting (only if **user-defined** safety position is selected).**

→ Select **position**.

→ Enter safety position  
(0% = closed, 100% = open).

✔ The safety position is now configured.

## 11.6 Adjustment of position controller – execute X.TUNE

When executing the X.TUNE function, the position control is adjusted at the physical stroke of the actuator in use.

Devices come with the X.TUNE function performed by the manufacturer.

### NOTE!

Only perform X.TUNE if required!

The X.TUNE function only has to be executed again if the actuator has been dismantled or the valve body has been replaced.



### WARNING!

Danger due to uncontrolled process after executing the X.TUNE function.

Executing X.TUNE under operating pressure will cause an adjuster error. The result is an uncontrolled process.

- ▶ Never perform X.TUNE under operating pressure.
- ▶ Secure the system against unintentional activation!

### 11.6.1 Adjustment of position controller with buttons in device

The two buttons for triggering X.TUNE are located beneath the blind cover.

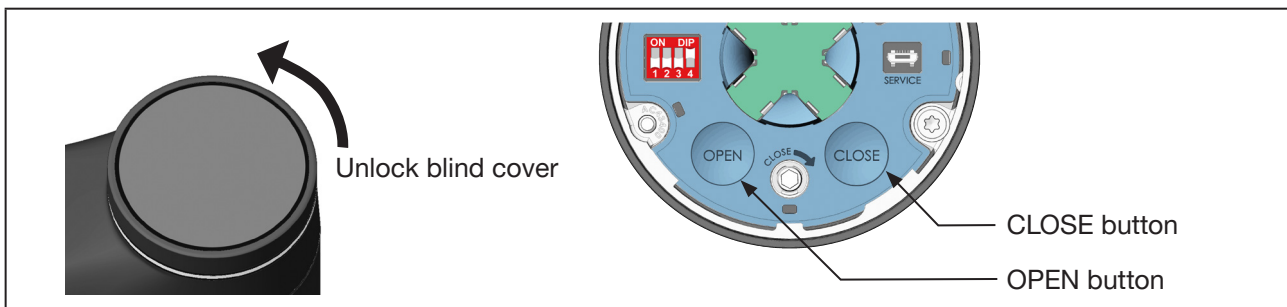

Fig. 37: Adjustment of position controller with buttons in device

Remove the blind cover:



**Devices with ATEX approval or IECEx approval are secured with a magnetic lock.**

The removal of the cover is described in the supplementary instructions for the electromotive control valves with ATEX approval and IECEx approval.

→ To unlock the blind cover, turn it counterclockwise and remove

Trigger the X.TUNE function:

⚠ Make sure that there is no operating pressure!  
Only perform X.TUNE when necessary.

→ Hold down the OPEN and CLOSE buttons together at the same time for 5 seconds.

The LED illuminated ring will light up orange while the X.TUNE is executed.

When X.TUNE is finished, the LED illuminated ring returns to its previous status.

## 11.6.2 Adjustment of position control on PC or device display



Settings are created on the PC using the bÜS service interface and the Bürkert Communicator software. It requires the USB-bÜS-Interface set available as an accessory.

Display operation: button functions

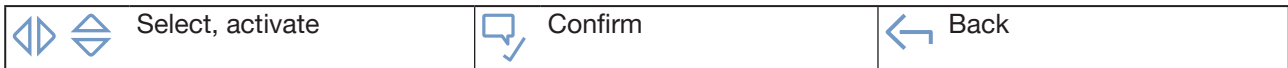

To trigger the X.TUNE function, you must switch to the “Maintenance” detailed view for position controllers.

**How to switch to detailed view:**

→ When using Bürkert Communicator for the configuration, select **Position Controller** in the navigation area and switch to **MAINTENANCE**.

→ When using the display for the configuration, switch to **CONFIGURATION** on the home screen, select **Position Controller** and switch to **MAINTENANCE**.

✓ You are now in the “Maintenance” detailed view.

**How to trigger the X.TUNE function:**

⚠ Make sure that there is no operating pressure!

→ Select **CALIBRATION**.

→ Select **X.TUNE**.

The following text appears: “Select seal material (see type label)!”

→ Select seal material.

The following question appears: “Do you really want to start X.TUNE?”

⚠ Only start X.TUNE if absolutely necessary.

→ Start X.TUNE.

✓ This will execute the X.TUNE function.



If X.TUNE is aborted due to an error, a message will appear (see subsequent table).

Possible messages when X.TUNE is aborted	Description
Device error present.	There is an error present that makes it impossible to execute X.TUNE.
Timeout.	X.TUNE could not be executed within the time limit due to an error.
The motor current is too great.	The motor current is too great to perform the X.TUNE function.
The lower end position of the valve is not recognised.	The lower end position of the valve cannot be recognised by the position sensor.

Table 38: Possible error messages after abort of the X.TUNE function

## 11.7 Set standard signal for set-point position







### Setting option:

Using the Bürkert Communicator software or the display of the device (optional).

Settings are created on the PC using the büS service interface and the Bürkert Communicator software. It requires the USB büS interface set available as an accessory.

Display operation: button functions

 	Select, activate		Confirm		Back
---	------------------	---	---------	---	------

To set the standard signal, switch to the “Parameters” detailed view for inputs/outputs.

### How to switch to detailed view:

→ When using Bürkert Communicator for the configuration, select **Inputs/Outputs** in the navigation area.

→ When using the display for the configuration, switch to **CONFIGURATION** on the home screen and select **Inputs/Outputs**.

✓ You are now in the “Parameter” detailed view.

### How to configure the standard signal:

→ Select **CMD**.

→ Select **ANALOG.type**.

→ Select standard signal.

✓ The standard signal is now configured.

## 11.8 Select physical unit for process control



### Setting option:

Using the Bürkert Communicator software or the display of the device (optional).

Settings are created on the PC using the bÜS service interface and the Bürkert Communicator software. It requires the USB bÜS interface set available as an accessory.

Display operation: button functions



To select the physical unit, switch to the “Parameters” detailed view for process controllers.

### How to switch to detailed view:

→ When using Bürkert Communicator for the configuration, select **Process Controller** in the navigation area.

→ When using the display for the configuration, switch to **CONFIGURATION** on the home screen and select **Process Controller**.

✓ You are now in the “Parameter” detailed view.

### How to select the physical unit for process control:

→ Select **UNIT**.

→ Select physical unit.

✓ The physical unit is now selected.

## 11.9 Configure process values





### Setting option:

Using the Bürkert Communicator software or the display of the device (optional).

Settings are created on the PC using the büS service interface and the Bürkert Communicator software. It requires the USB büS interface set available as an accessory.

Display operation: button functions

 Select, activate	 Confirm	 Back
--	---	--

To configure process values, you must go to the “Parameters” detailed view for inputs/outputs.

### How to switch to detailed view:

→ When using Bürkert Communicator for the configuration, select **Inputs/Outputs** in the navigation area.

→ When using the display for the configuration, switch to **CONFIGURATION** on the home screen and select **Inputs/Outputs**.

✔ You are now in the “Parameter” detailed view.

### 11.9.1 Selecting and scaling standard signal for process set-point value

How to select the standard signal for the process set-point value:

→ Select **SP/CMD**.

→ Select **ANALOG.type**.

→ Select standard signal.

→ ✔ The standard signal for the process set-point value is now selected.

How to scale the process set-point value:

→ Select **SP.scale**.

→ Enter the minimum and maximum values.

✔ The process set-point value is now configured.

### 11.9.2 Selecting and scaling standard signal for process actual value

How to select the standard signal for the process actual value:

→ Select **PV**.

→ Select **ANALOG.type**.

→ Select standard signal.

✔ The standard signal for the process actual value is now selected.

How to scale the process actual value:

→ Select **PV.scale**.

→ Enter the minimum and maximum values.

✔ The process actual value is now configured.



## 11.10 Scaling the process control

Scaling process control affects the following functions:

- Dead band for process control
- Sealing function (CUTOFF), if process control (P.CO) is selected in menu CUTOFF → CUTOFF.type.



### Setting option:

Using the Bürkert Communicator software or the display of the device (optional).

Settings are created on the PC using the büS service interface and the Bürkert Communicator software. It requires the USB büS interface set available as an accessory.

Display operation: button functions



To scale process control, switch to the “Parameters” detailed view for process controllers.

### How to switch to detailed view:

- When using Bürkert Communicator for the configuration, select **Process Controller** in the navigation area.
- When using the display for the configuration, switch to **CONFIGURATION** on the home screen and select **Process Controller**.

✔ You are now in the “Parameters” detailed view.

### How to scale process control:

- Select **P.CO.scale**.
- Enter the minimum and maximum values.
- ✔ The process control is now scaled.

## 11.11 Set dead band for process control



### Setting option:

Using the Bürkert Communicator software or the display of the device (optional).

Settings are created on the PC using the bÜS service interface and the Bürkert Communicator software. It requires the USB bÜS interface set available as an accessory.

Display operation: button functions

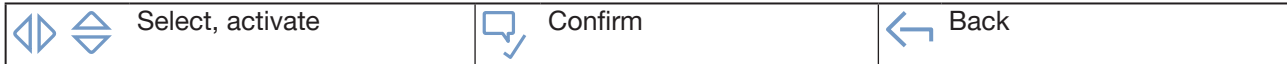

To set the dead band, switch to the “Parameters” detailed view for process controllers.

### How to switch to detailed view:

- When using Bürkert Communicator for the configuration, select **Process Controller** in the navigation area.
- When using the display for the configuration, switch to **CONFIGURATION** on the home screen and select **Process Controller**.

✔ You are now in the “Parameters” detailed view.

### How to configure the dead band:

- Select **PID.PARAMETER**.
  - Select **DBND**.
  - Enter percentage value.
- ✔ The dead band is now configured.

## 11.12 Setting up process control and executing P.LIN, P.TUNE



### Setting option:

Using the Bürkert Communicator software or the display of the device (optional).

Settings are created on the PC using the bÜS service interface and the Bürkert Communicator software. It requires the USB bÜS interface set available as an accessory.

Display operation: button functions

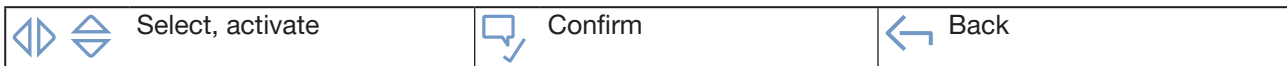

To set up process control, switch to the “Maintenance” detailed view for process controllers.

### How to switch to detailed view:

- When using Bürkert Communicator for the configuration, select **Process Controller** in the navigation area and switch to **MAINTENANCE**.
- When using the display for the configuration, switch to **CONFIGURATION** on the home screen, select **Process Controller** and switch to **MAINTENANCE**.

✓ You are now in the “Maintenance” detailed view.

### 11.12.1 Linearising process characteristic (P.LIN)

#### How to linearise the process characteristic:

- Select **CALIBRATION**.
- Select **P.LIN**.
- The following text appears: “Do you really want to start P.LIN?”
- Start P.LIN.

✓ This will execute the P.LIN function.

### 11.12.2 For devices without a display – activate the correction characteristic

DIP switch 2, which is located under the blind cover, is used to activate the correction characteristic.

→ To unlock the blind cover, turn it counterclockwise and remove.



**Devices with ATEX approval or IECEx approval are secured with a magnetic lock.**

The removal of the cover is described in the supplementary instructions for the electromotive control valves with ATEX approval and IECEx approval.

→ Set DIP switch 2 to ON. The correction characteristic is now enabled.

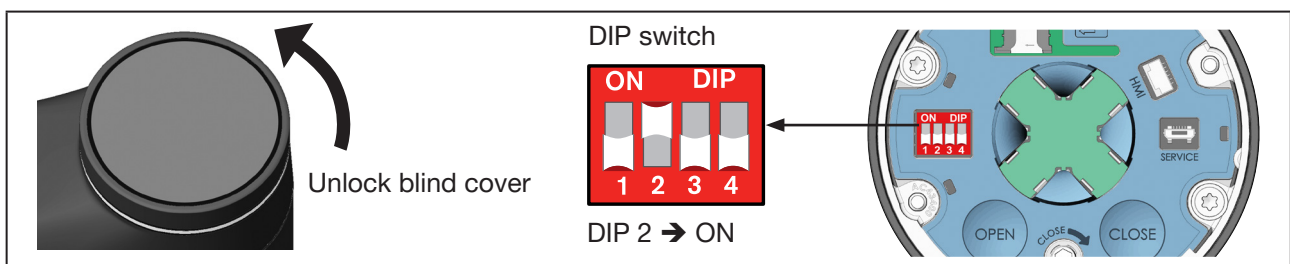

Fig. 38: Activate the correction characteristic

→ Close the blind cover.

### 11.12.3 Adjusting process control (P.TUNE)

How to trigger the P.TUNE function:

→ Select **CALIBRATION**.

→ Select **P.TUNE**.

The following text appears: “Do you really want to start P.TUNE?”

→ Start P.TUNE.

✓ This will execute the P.TUNE function.



The LED illuminated ring will light up orange while the functions P.LIN and P.TUNE are executed. If it is aborted due to an error, a message will appear.

## 11.13 Set AUTOMATIC operating state

Factory setting: Devices in their factory default state have their operating state preset to MANUAL.

### 11.13.1 Setting AUTOMATIC operating state for devices without a display module

DIP switch 4, which is located under the blind cover, is used to set the operating state.



**Devices with ATEX approval or IECEx approval are secured with a magnetic lock.**

The removal of the cover is described in the supplementary instructions for the electromotive control valves with ATEX approval and IECEx approval.

→ To unlock the blind cover, turn it counterclockwise and remove.

→ Set AUTOMATIC operating state with DIP switch 4.

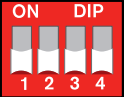
	<b>Operating state</b>	
	<b>AUTOMATIC:</b> DIP 4 → down	<b>MANUAL:</b> DIP 4 → up (ON)

→ Close the blind cover.

### 11.13.2 Setting AUTOMATIC operating state for devices with a display module

This setting is changed in the Process Control layout.



The Process Control layout is pre-defined in factory settings for the home screen (factory designation: View 1...).

To access the home screen, hold down the ← Back key.

See also chapter [“13.3.1 Home screen and user-specific views“](#) on page 94).

→ To change the operating mode, briefly press the  Menu button.

AUTOMATIC operating state: The MANUAL icon  and the two arrow icons labelled “open” and “close” are hidden.

**Home screen** (factory designation: View 1...)  
 Layout: Process Control  
 Display: in MANUAL operating state.

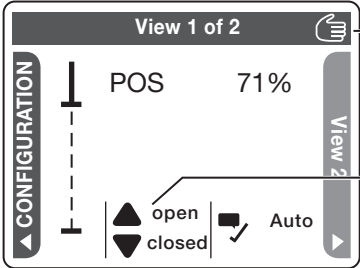

Icon for MANUAL operating state: MANUAL icon is displayed  
 AUTOMATIC: MANUAL icon is hidden

Arrow icons labelled “open” and “close”  
 MANUAL: Arrow icons are displayed  
 AUTOMATIC: Arrow icons are hidden

Fig. 39: Icons for operating state

→ Set AUTOMATIC operating state.

## 12 OPERATION



### WARNING!

#### Risk of injury from improper operation!

Improper operation may result in injuries as well as damage to the device and its surroundings.

- ▶ The operating personnel must know and understand the contents of the operating instructions.
- ▶ The safety instructions and the intended use must be observed.
- ▶ Only adequately trained personnel may operate the system/device.

Different operating elements are available for operating the device, depending on the variant.

- **Standard devices without display module**

Operation is performed with 2 capacitive buttons and 4 DIP switches.

- **Option – devices with display module**

Operation and configuration are performed on the display with buttons for touch operation.

- **Additional operating options**

Alternatively, the device can be configured using a PC. Settings are created using the bÜS service interface and the Bürkert Communicator software.

It requires the USB-bÜS-Interface set available as an accessory.

### 12.1 Overview: availability of the operating elements

Operating element	Function	Availability	
		Devices without display module	Devices with display module
4 DIP switches	Set effective direction	yes	no (available, but without function. Configuration via display)
	Enabling, disabling correction characteristic		
	Enable, disable sealing function		
	Switch to AUTOMATIC, MANUAL operating state		
OPEN button	Opening the valve	yes	
CLOSE button	Closing the valve	yes	
OPEN button and CLOSE button	Adjustment of position control, perform X.TUNE function	yes	
Mechanical manual override	Mechanically opening or closing the valve	yes	yes
SIM card holder	Holder for using the SIM card available as an accessory	yes	yes
bÜS service interface (only for analogue)	For connecting a CAN adapter or the USB bÜS interface set available as an accessory	yes	yes
Bürkert Communicator software	Software for configuration and setting the device on a PC	yes	yes
Display with buttons for touch operation	Configuring, setting and operating the device	no	yes

Table 39: Operating possibilities

## 12.2 Display elements

Description of the display elements:

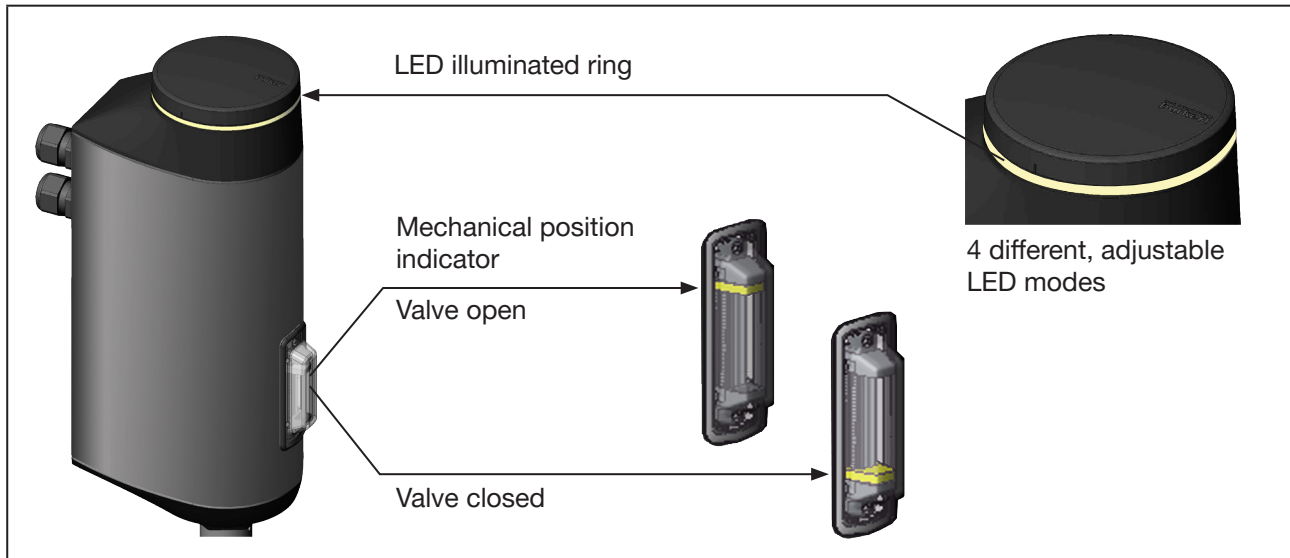

Fig. 40: Display elements

### 12.2.1 LED illuminated ring

The transparent LED light ring that transmits the light of the LEDs to the outside is fitted to the blind cover or display module.

The LED illuminated ring lights up or flashes slowly or quickly in one or several alternating colours to indicate the device's state.

4 different LED modes can be set for the LED light ring:

- NAMUR operation mode\*
- Valve mode\*
- Valve mode + warnings\* – factory pre-set operation mode
- LED off



\* The complete description of the device states, errors and warnings that are displayed in LED mode can be found in chapter [“6.5 Display of the device status”](#).

## 12.2.2 Set LED operation mode



### Setting option:

Using the Bürkert Communicator software or the display of the device (optional).

Settings are created on the PC using the büS service interface and the Bürkert Communicator software. It requires the USB büS interface set available as an accessory.

Display operation: button functions

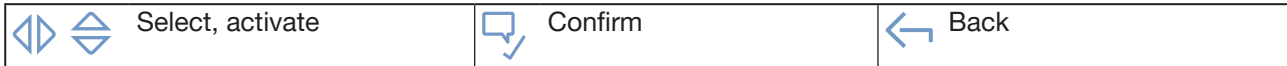

To configure, you must switch to the detailed view “Parameter for general settings”.

### How to switch to detailed view:

→ When using Bürkert Communicator for the configuration, select **General settings** in the navigation area.

→ When using the display for the configuration, switch to **CONFIGURATION** on the home screen and select **General settings**.

✔ You are now in the “Parameter” detailed view.

### How to set LED operation mode:

→ Select **Status LED**.

→ Select **Operation mode**.

The following LED operation modes are available:

**NAMUR operation mode**

**Valve mode**

**Valve mode + warnings**

**LED off**

→ Select LED operation mode.

✔ You have set the LED operation mode.

## 12.2.3 Mechanical position indicator

The valve position is read from the mechanical position indicator even if the supply voltage fails (see “[Fig. 40: Display elements](#)”)

## 12.2.4 Display elements of the display module (optional)

For a description see “[13 Display operation \(option\)](#)”



## 12.3 Operating elements

Presentation of the operating elements:

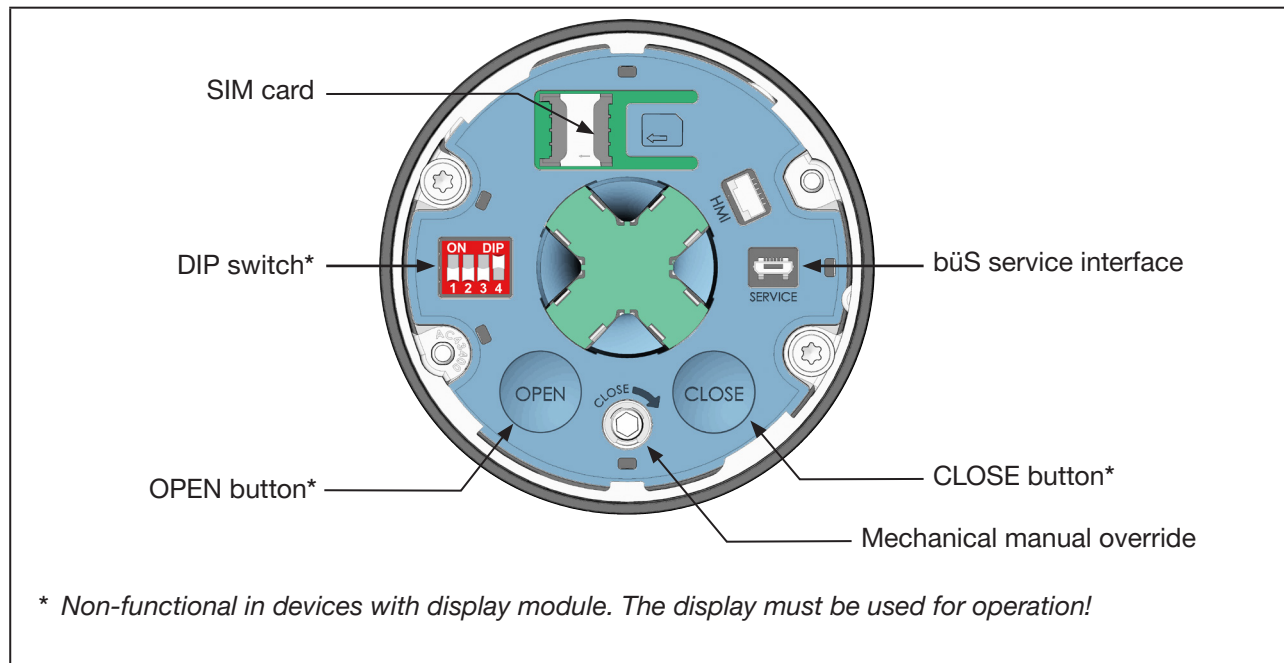

Fig. 41: Operating elements

### 12.3.1 DIP switch

#### Settings

- Switch 1: Sets the effective direction between input signal and set-point position. See chapter “14.4” on page 110.
- Switch 2: Enables or disables the correction characteristic (for adjusting the operating characteristic) (see chapter “14.3” on page 107).
- Switch 3: Enables or disables sealing function. See chapter “14.2” on page 105.
- Switch 4: Switch between AUTOMATIC and MANUAL operating state. See chapter “14.1” on page 102.



The DIP switches are non-functional in devices with a display module. The configuration can only be performed on the display.

### 12.3.2 OPEN button and CLOSE button

- Electrical manual override: Open valve: to open, press OPEN key  
Close valve: press CLOSE button. See chapter “15.1”.
- Trigger X.TUNE: For a description see chapter “11.6 Adjustment of position controller – execute X.TUNE”.



If the device has a display module, the OPEN and CLOSE buttons will have no function. The configuration can be performed on the display.

### 12.3.3 Mechanical manual override

If there is no supply voltage, e.g. during installation or in the event of a power failure, the valve can be opened or closed using the mechanical manual override.

For a description see chapter [“15.4 Actuating the valve mechanically”](#)

## 12.4 büS service interface



For AG3 with büS, CANopen and fieldbus gateway, the büS service interface is inactive. Only use circular plug X? as a büS interface for these devices.

The büS service interface can be used for quick service.

- Configuration of the device, e.g. the base setting for start-up with the software Bürkert Communicator. It requires the USB-büS-Interface set available as an accessory.
- Configuration of the büS network.
- Parameterising of operation parameters
- Error diagnostics
- Software update

Only connect the matching CAN adapter to the büS service interface. This CAN adapter is part of the USB büS interface set available as an accessory (see [“Table 52: Accessories”](#) on page 161).

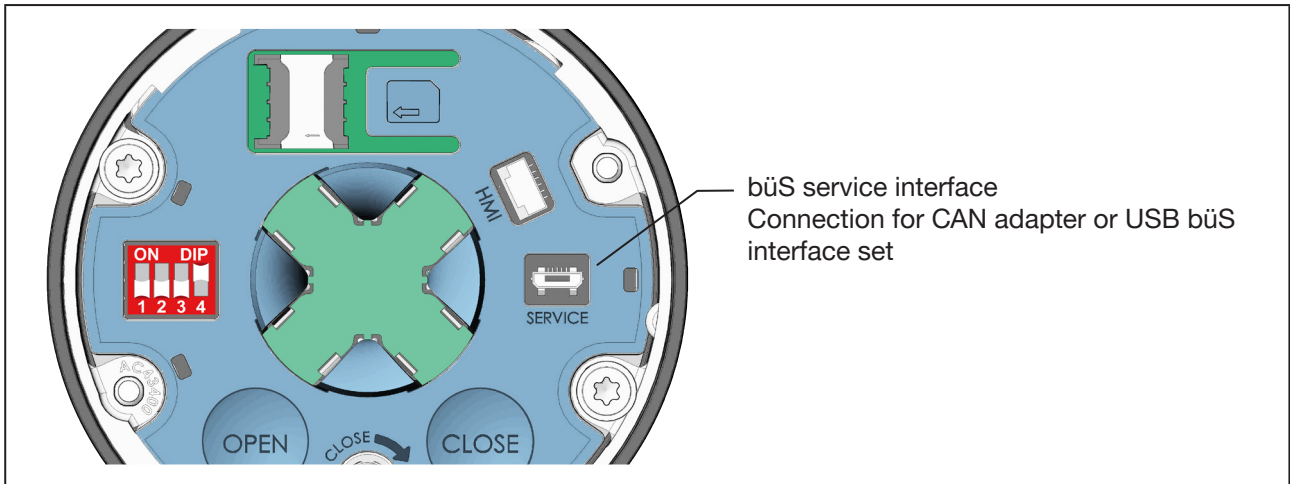

Fig. 42: büS service interface



For devices with a fieldbus gateway, the büS service interface is inside the fieldbus gateway (see chapter [“18.1 Fieldbus gateway description”](#) on page 145).

## 12.5 SIM card – acquire and save data (option)

The optional SIM card can be used to store device-specific values and user settings and transfer them to another device.



When a SIM card is inserted, the configuration client (for bÜS devices) is deactivated. You can find additional information under the search term “central configuration management” at our webpage: [country.burkert.com](http://country.burkert.com)

The SIM card is detected when the device starts and is checked for available data. This data will be transferred or overwritten accordingly:

- The SIM card does not contain any data.  
The existing device-specific values and user settings are saved to the SIM card.
- The SIM card contains data compatible with the device.  
The data on the SIM card are transferred by the device. The existing device-specific values and user settings are overwritten.
- The SIM card contains data that are not compatible with the device.  
The device overwrites the data on the SIM card with its own device-specific values and user settings.

### NOTE!

#### Do not use a standard SIM card for the device.

The SIM card used is a special industrial version that offers additional durability and temperature-resistance.

Only purchase the SIM card for the electromotive control valves from your Bürkert sales department. See chapter “24 Accessories, Wearing parts”.

#### Do not remove the SIM card during operation.

During operation, parameter changes are immediately saved to the SIM card.

If the SIM card is removed during operation, data may be lost and the SIM card damaged.



The SIM card can be inserted during operation. A restart is required to ensure that the device detects the SIM card.

### Inserting the SIM card:

- Place the SIM card on the surface with the SIM card symbol. The position must correspond to that shown on the symbol.
- Gently push the SIM card to the left into the holder until it stops.
- Restart the device. The new data are transmitted.

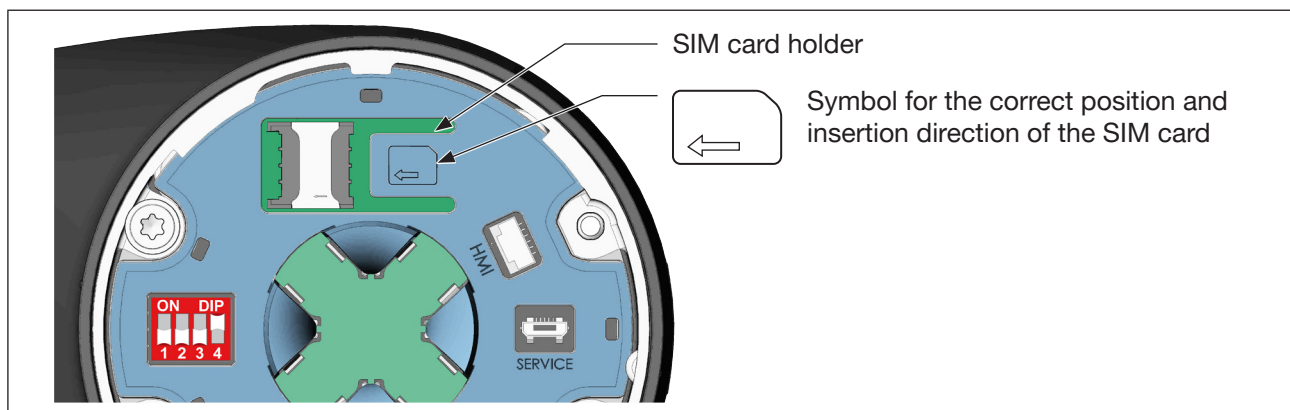

Fig. 43: Using the SIM card

## 13 DISPLAY OPERATION (OPTION)

The device is operated and configured using buttons on a touchscreen display.

### 13.1 User interface

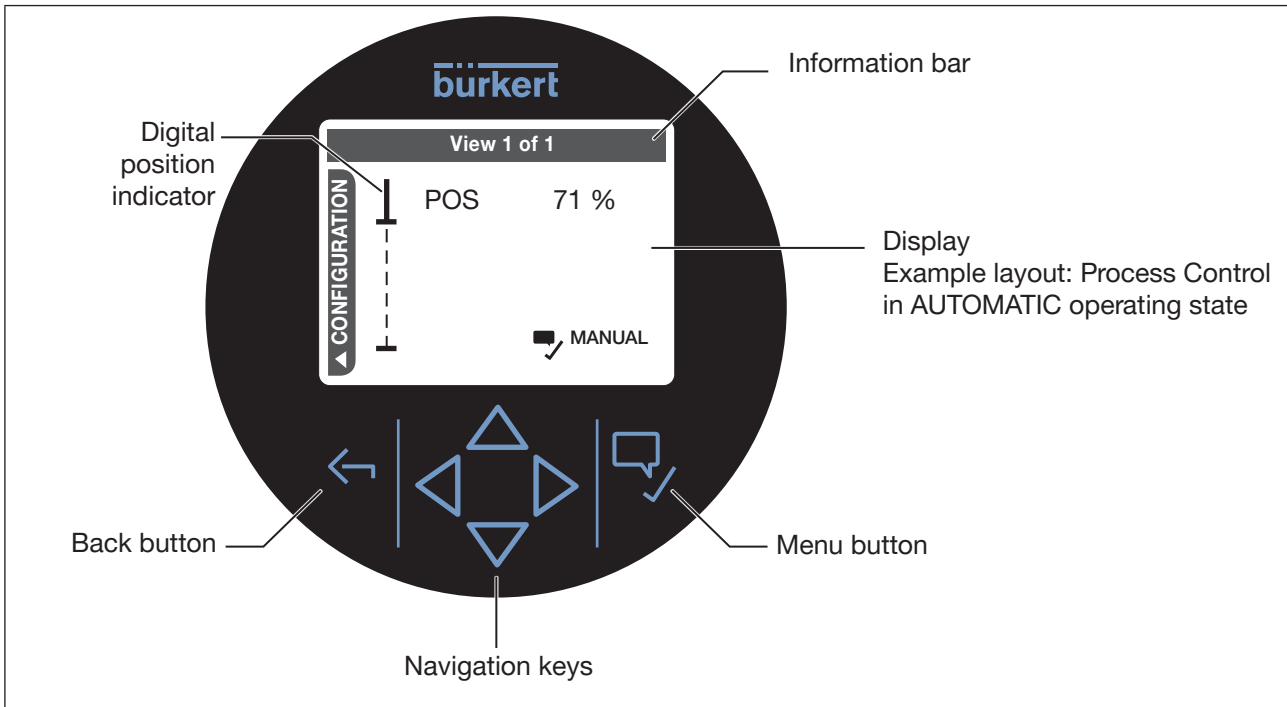

Fig. 44: User interface

### 13.2 Description of buttons

Key		Functions	
Back button		Press briefly:	Back
		Hold down:	Return to home screen (View 1...)
Navigation keys		Change view	
		Accept selection (e.g. with option fields)	
		When entering values: change decimal place	
		Select menu	
		Configuration, select setting	
		When entering values: change value (figure)	
		Open valve (in MANUAL operating state)	
	Close valve (in MANUAL operating state)		

Key		Functions	
Menu button		Press briefly:	Confirm selection
			Save selection
			Next (in wizard)
		Hold down:	Open context menu

Fig. 45: Description of button function

### 13.3 Display views

The following views can be accessed from the home screen:

- Configuration view, using the left navigation button ◀
- From user-created view 2–4, using the right navigation button ▶  
 See also [“13.3.1 Home screen and user-specific views”](#) on page 94.

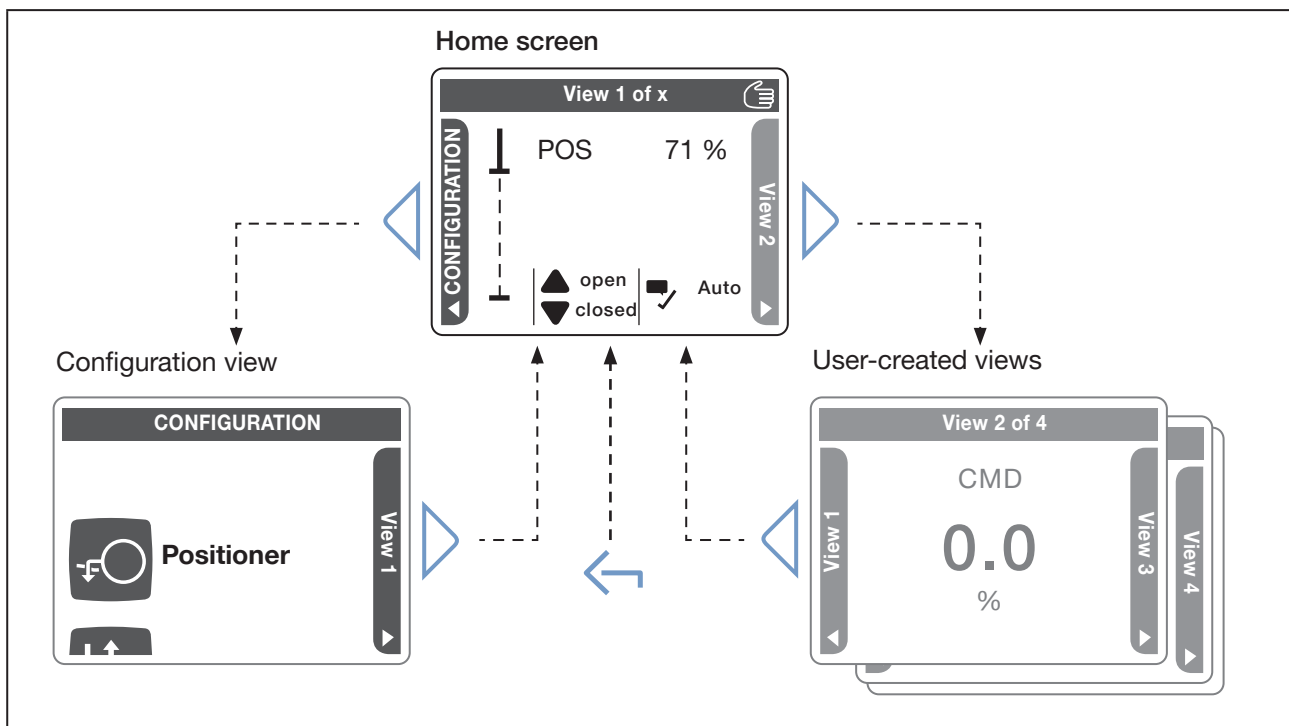

Fig. 46: Home screen, configuration view, user-specific views

MAN 1000274112 EN Version: H Status: RL (released | freigegeben) printed: 26.01.2023

### 13.3.1 Home screen and user-specific views

In addition to the home screen, other user-specific views can be created. The title of the view is displayed in the information bar.



The home screen title preset at the factory (View 1...) and the other views can be changed in the context menu.

Five different layouts are available for each view:

<b>1 value</b>	1 process value is displayed in the view.
<b>2 values</b>	2 process values are displayed in the view.
<b>4 values</b>	4 process values are displayed in the view.
<b>Trend</b>	The process sequence is depicted as a curve in the view.
<b>Trend with 2 values</b>	The process sequence is depicted as a curve and with 2 process values in the view.
<b>Process Control</b>	Preset at the factory for the home screen (see “Fig. 46”). The position of the valve is depicted as a value and in a position indicator in the view. The icons for AUTOMATIC and MANUAL operating state, and for closing and opening the valve, are displayed.
<b>Setting:</b>	You can create views, change their title and assign the layout either in the context menu on the home screen or from a user-specific view. To open the context menu, hold down the menu key  .



The comprehensive, detailed description for the display module can be found on our homepage <https://country.burkert.com/> under: Type ME31 → Software ME31.

### 13.3.2 Configuration view

The configuration view is divided in various areas.











Icon	Configuration area
	Positioner
	Inputs/outputs
	Process controller
	Industrial communication
	Displays
	General settings

Table 40: Configuration areas

You can switch between the areas with the navigation buttons  and .

### 13.3.3 Detailed views

From the configuration view you can access the following detailed views:

Detailed view	How to access the detailed view from the configuration view
Parameters	Select  Configuration area* and  confirm selection.
Maintenance	Select  Configuration area* and  confirm selection.  Switch to detailed view <b>MAINTENANCE</b> .

\* See "Table 40: Configuration areas" on page 95.

Table 41: Detailed views

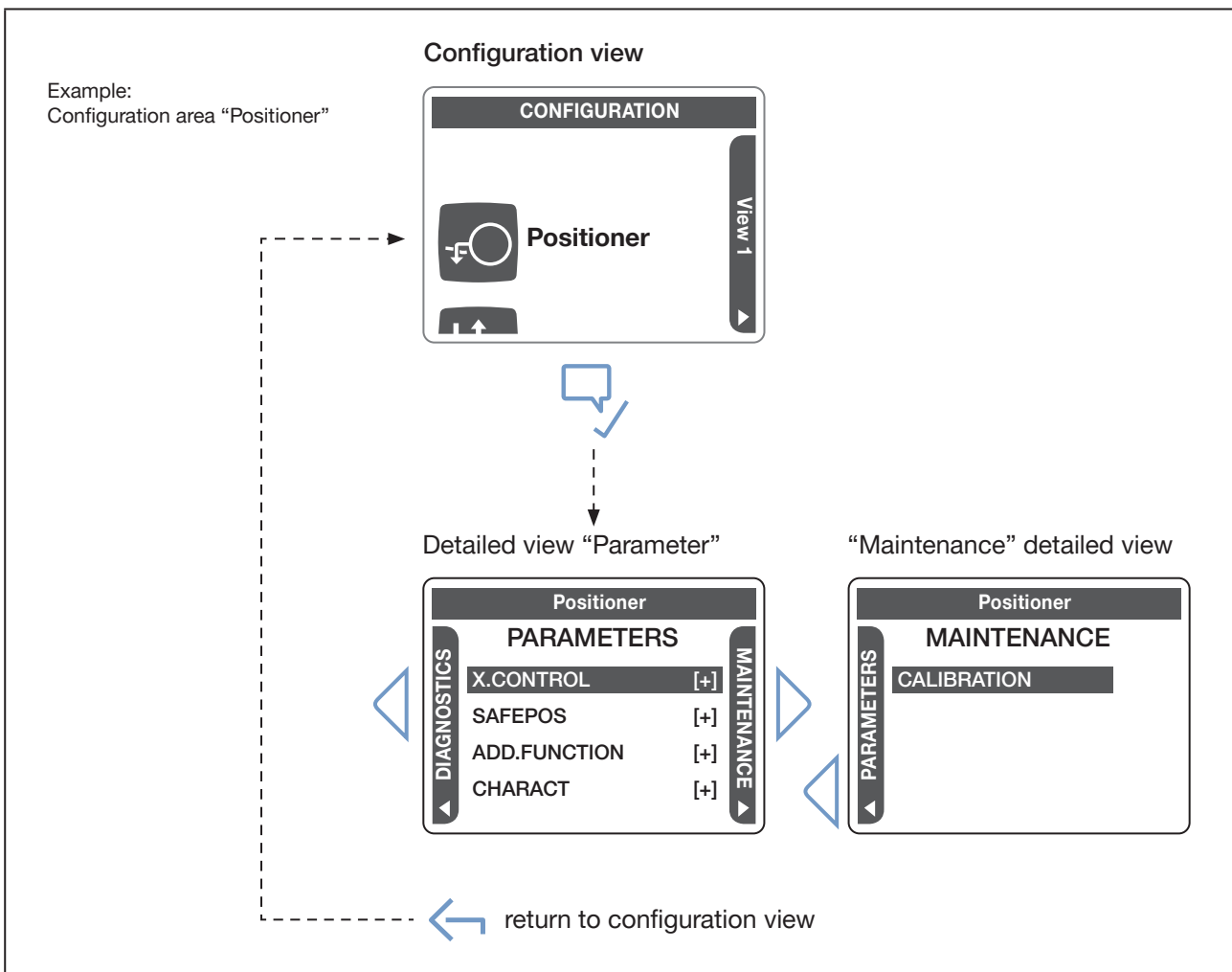

Fig. 47: Detailed views; Parameter, Maintenance, Diagnostics



## 13.4 Description of symbols

### Symbols for access rights





Icon	Description
	This setting is write-protected and can only be modified with the appropriate access rights/ user code.
	User
	Advanced user is logged on to the device.
	Installer is logged on to the device.
	Bürkert service employee is logged on to the device.

Table 42: Symbols for access rights



The rights to read, configure or alter data depend on the set access right and password protection. See chapter “13.5 Access rights and password protection“ on page 99.

### Icons for indicating device status in accordance with NAMUR NE 107

If several device statuses exist simultaneously, the device status with the highest priority is displayed.





Priority	Icon	Description
1		Failure, error or fault! Due to a malfunction in the device or its peripherals, closed-loop control mode is not possible. → Review the messages in the message list.
2		Function check! Work is being carried out on the device, which means that closed-loop control mode is temporarily not possible.
3		Outside of specification! The environment conditions or process conditions for the device are not within the specified range. Internal device diagnostics indicate problems within the device or with the process properties.
4		Maintenance required! The device is in closed-loop control mode, but function will soon be restricted. → Perform device maintenance.

Table 43: Symbols in accordance with NAMUR NE 107

### Symbols for displaying operating states







Priority	Icon	Description
1		Device is no longer in closed-loop control mode due to a severe error. The valve is stuck in its position.
2		Energy-pack active: The supply voltage has been interrupted. The device is supplied with power via the energy pack. In AUTOMATIC operating state the actuator moves to the safety position (see icon "safety position") In MANUAL operating state the actuator is stuck in the last assumed position.
3		Device is in MANUAL operating state.
4		Device is in SIMULATION operating state. The signal for the set-point value setting default is simulated.
5		Process control active
6		Position control active

Table 44: Symbols for displaying operating states

### Symbols for displaying specific valve positions



Priority	Icon	Description
1		Valve is in the safety setting.
2		Valve is in the sealed position.

Table 45: Symbols for displaying specific valve positions

## 13.5 Access rights and password protection

There are three user levels for assigning access rights.

If password protection is enabled, the information bar of the display displays the enabled user level with the corresponding icon.



User level	Icon	Description
Advanced user		PIN required: factory-set code 005678 Rights: Reading values, limited right to change values.
Installer		PIN required. Manufacturer-set code 001946 Rights: Reading values, expanded right to change values.
Bürkert		PIN required. Only for Bürkert employees

Table 46: User levels

### 13.5.1 Factory setting





Password protection is not enabled on delivery. Settings in the software can be made at any time and without entering a password.

A password is only required for settings that only Bürkert employees are permitted to make.







### 13.5.2 Enabling password protection

You must switch to the detailed view “Parameters for general settings” to enable or disable password protection.









**How to switch from the home screen to the detailed view:**

-  switch to **CONFIGURATION**.
-   Select **General settings** and  confirm selection.
- ✔ You are now in the “Parameter” detailed view.

**How to enable password protection and change passwords:**

-  Select **Passwords** and  confirm.
-  Select **Password protection** and  confirm.
-  Select **On** and  confirm.
- ✔ You have enabled password protection.  
Effect: Software settings that require a specific user level can only be made upon entering the corresponding user level code.
- Return with .

After password protection is enabled, you can change the passwords for the user levels.

-  Select **Change passwords** and  confirm.
-  Select user level and confirm .
- Enter code: add with decimal point with ; change value of the decimal point with .
- Confirm the set code .
- ✔ You have changed the user level password.
- Return with .



**Note!** Document passwords such that they are always accessible to authorised persons.







Once the screen saver is active, settings that require a certain user level are only possible with input of a password.



When password protection is enabled, the user level **Installer** is required to change the password protection.

### 13.5.3 Disabling password protection

The user level **Installer** is required to disable password protection.

- In the detailed view **General settings**,  select **Passwords** and  confirm.
-  Select **Password protection** and  confirm.
-  Select **Off** and  confirm.
- ✔ You have disabled password protection.
- Return with .



### 13.5.4 Changing user level

To change the user level you must switch to the context menu. Hold down the menu button .

**How to switch user levels:**

-  Select **Switch user levels**.
- Select user level.
- Set password (PIN).
- ✔ You have switched the user level.

**Logging out of the user level:**

-  Select **Log out** and  confirm.
- ✔ You have disabled the user level.

## 13.6 Screen saver

The display user interface is protected by a screen saver. Removing the screen saver:

→ Press any button and follow the instructions on the display.

Factory setting: The waiting time between operation and enabling of the screen saver is one minute.

### NOTE!

Faulty operation as a result of EMC disruptions, cleaning work or unintended physical contact.

▶ To prevent faulty operation, set the shortest possible waiting time for the screen saver, e.g. one minute.

### 13.6.1 Set screen saver

The setting is made in the detailed view “Parameter for displays”.

How to switch from the home screen to the detailed view:



→  switch to **CONFIGURATION**.



→   Select **Displays** and  confirm selection.

✔ You are now in the “Parameter” detailed view.

How to set the screen saver:

→  select **Screen saver** and  confirm.

→  Select **Waiting time** and  confirm.

→  Select desired waiting time in **minutes** and  enable.

→  Select **Brightness** and  confirm.

→  Set desired brightness in % and  confirm.

✔ You have set the screen saver.

→ Return with .

## 14 BASIC FUNCTIONS

### 14.1 Changing the operating state, AUTOMATIC, MANUAL

Factory setting: Devices in their factory default state have their operating state preset to MANUAL.

#### 14.1.1 Changing operating state in devices without a display module

DIP switch 4, which is located under the blind cover, is used to change operating state.

→ To unlock the blind cover, turn it counterclockwise and remove



**Devices with ATEX approval or IECEx approval are secured with a magnetic lock.**

The removal of the cover is described in the supplementary instructions for the electromotive control valves with ATEX approval and IECEx approval.

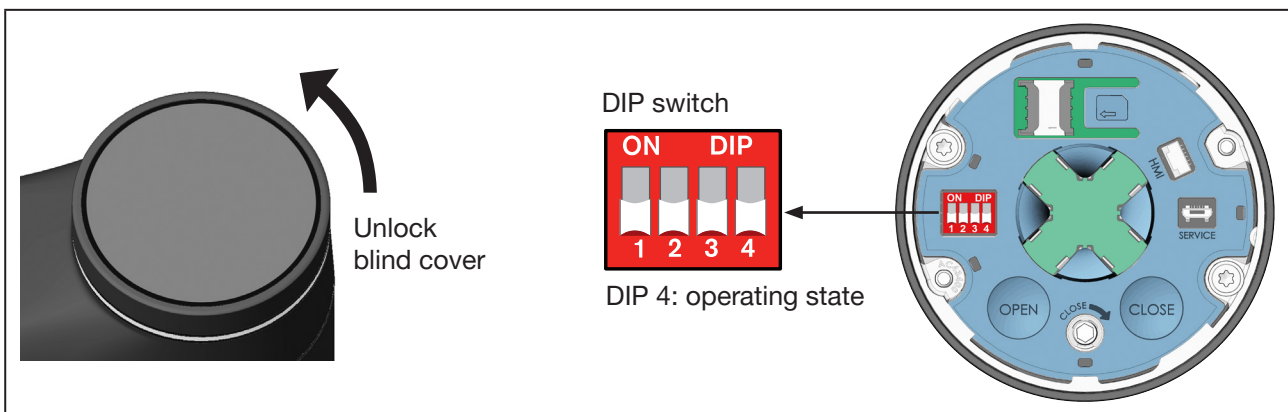

Fig. 48: Setting the operating state

→ Set the operating state with DIP switch 4.

	<b>Operating state</b>	
	<b>AUTOMATIC:</b> DIP 4 → down	<b>MANUAL:</b> DIP 4 → up (ON)

→ Close the blind cover.

## 14.1.2 Changing operating state in devices with a display module

The operating state can be set in 2 ways:

- using the menu key in the Process Control layout on the home screen or in a user-specific view.
- in the menu **AUTO I MANU**, located in the configuration area **General settings**.

### Setting using the menu button

You can change the operating state in the home screen or in a view.

If you want to change the operating state using the menu key, the view of the display must be in the Process Control layout. See "Fig. 49".

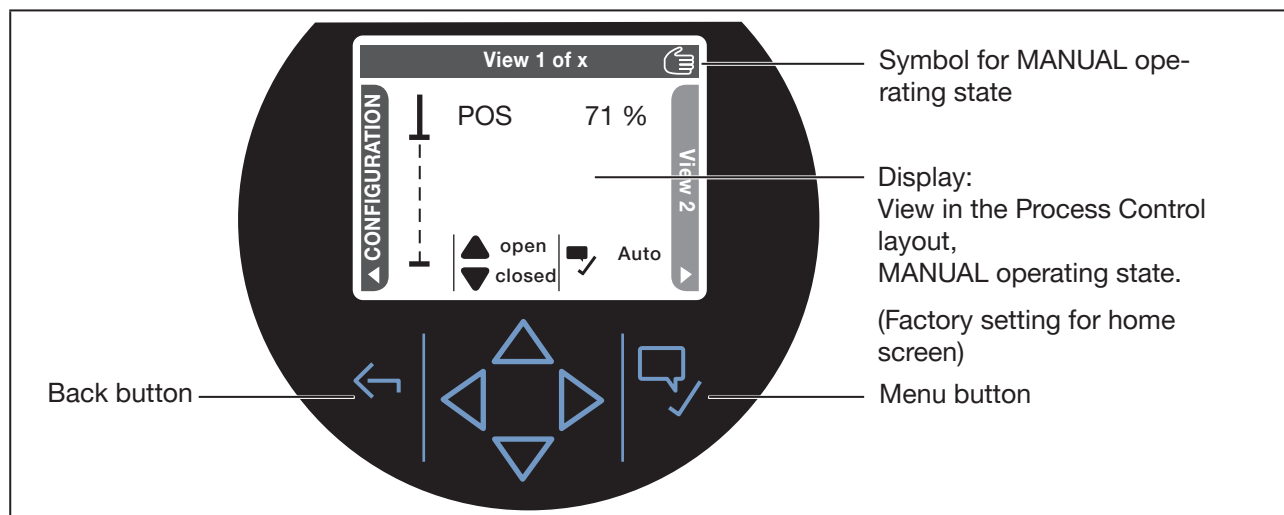



Fig. 49: Changing the operating state, MANUAL – AUTOMATIC

→ To change the operating mode, briefly press the  Menu button.

**MANUAL:** The MANUAL symbol  appears in the information bar at the top. The two arrow symbols labelled "open" and "close" are displayed.

**AUTOMATIC:** The MANUAL symbol  and the two arrow icons labelled "open" and "close" are hidden.



#### Setting the layout:

The layout is set in the context menu: To open the context menu, hold down the menu button .

#### Process Control factory setting:

The Process Control layout is pre-defined in factory settings for the home screen (factory designation: View 1...).

To access the home screen, hold down the  back key.

See also chapter "13.3 Display views" on page 93.

## Setting in the menu AUTO | MANU



### Setting option:

Using the Bürkert Communicator software or the display of the device (optional).

Settings are created on the PC using the büS service interface and the Bürkert Communicator software. It requires the USB büS interface set available as an accessory.

Display operation: button functions

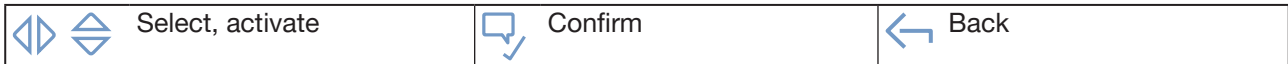

To configure, you must switch to the detailed view “Maintenance for general settings”.

How to switch to detailed view:

→ When using Bürkert Communicator for the configuration, select **General settings** in the navigation area and switch to **MAINTENANCE**.

→ When using the display for the configuration, switch to **CONFIGURATION** on the home screen, select **General settings** and switch to **MAINTENANCE**.

✓ You are now in the “Maintenance” detailed view.

How to set the operating state:

→ Select **AUTO | MANU**.

→ Select **Automatic mode** or **Manual mode**.

✓ You have set the operating state.



The MANUAL operating state includes the menu **AUTO | MANU** and the menu **Manual mode** for manual override of the valve.



## 14.2 Enable – disable sealing function

**Factory setting:** The sealing function is disabled in devices upon delivery.

This function causes the valve to seal or open completely within the set range.

The parameters for the sealing or opening of the valve (CMD) is stated in per cent. The transfer from sealing or opening to closed-loop control mode occurs with a hysteresis of 1%.

If the process valve is in the sealing range, an icon appears on the display.

### 14.2.1 Enabling or disabling sealing function in devices without a display module



The sealing function must be configured for enabling. Configuration is performed on a PC via the bÜS service interface and with the Bürkert Communicator software. It requires the USB-bÜS-Interface set available as an accessory.

The process for configuration on a PC is the same as on the device display. Configuration is described in chapter “14.2.3 Configuring the sealing function”.

DIP switch 3, which is located under the blind cover, is used to enable the sealing function.



**Devices with ATEX approval or IECEx approval are secured with a magnetic lock.**

The removal of the cover is described in the supplementary instructions for the electromotive control valves with ATEX approval and IECEx approval.

→ To unlock the blind cover, turn it counterclockwise and remove

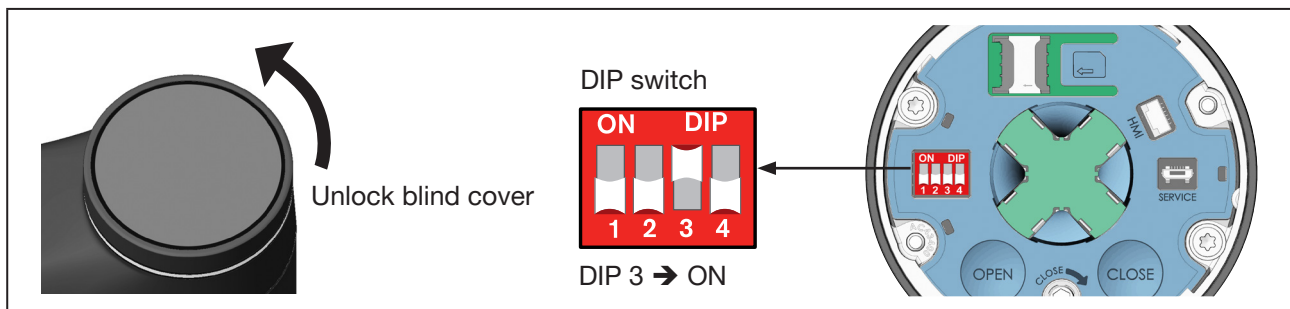

Fig. 50: Enable sealing function

→ Set DIP switch 3 to ON. The sealing function is enabled.

→ Close the blind cover.

## 14.2.2 Enable or disable sealing function in devices with a display module

To enable or disable the sealing function, you must switch to the detailed view “Parameter for position controller”.

How to switch from the home screen to the detailed view:

→  switch to **CONFIGURATION**

→   select **Position controller** and  confirm selection.

✓ You are now in the “Parameter” detailed view.

How to enable the sealing function:

→  select **ADD.FUNCTION** and  confirm.

→  Select **CUTOFF**, enable with the navigation buttons  on the side and  confirm.

The device returns to the “Parameter” detailed view.

The sealing function is enabled and the menu **CUTOFF** for configuration is now available in the “Parameter” detailed view.

→ Return with .

## 14.2.3 Configuring the sealing function





### Setting option:

Using the Bürkert Communicator software or the display of the device (optional).

Settings are created on the PC using the bÜS service interface and the Bürkert Communicator software. It requires the USB bÜS interface set available as an accessory.

Display operation: button functions

	Select, activate		Confirm		Back
---	------------------	---	---------	---	------

To configure the sealing function, you must switch to the detailed view “Parameter for position controller”.

How to switch to detailed view:

→ When using Bürkert Communicator for the configuration, select **Position Controller** in the navigation area.

→ When using the display for the configuration, switch to **CONFIGURATION** on the home screen and select **Position controller**.

How to configure the sealing function:

→ Select **CUTOFF** in the detailed view “Parameter”.

→ Select **Lower limit**.

→ Enter lower limit.

→ Select **Upper limit**.

→ Enter upper limit.

✓ You have configured the sealing function.

## 14.3 Enabling – disabling correction characteristic

**Factory setting:** The correction characteristic is disabled in devices on delivery.

When the correction characteristic is enabled, the flow characteristic or operating characteristic is corrected depending on the set-point position (CMD) and valve stroke (POS).

### Flow characteristic:

The flow characteristic  $k_v = f(s)$  indicates the flow rate of a valve, expressed by the  $k_v$  value, as a function of the stroke  $s$  of the actuator spindle. The flow characteristic is determined by the shape of the valve seat and the valve seat seal. Two types of flow characteristics are generally realised: the linear and the equipercentile.

With linear characteristics, equal stroke changes are apportioned the same  $k_v$  value changes  $dk_v$ .

$$(dk_v = n_{lin} \cdot ds).$$

With equipercentile characteristics, a change in stroke  $ds$  corresponds to an equipercentile change in the  $k_v$  value.

$$(dk_v/k_v = n_{equiperc} \cdot ds).$$

### Operating characteristic:

The operating characteristic  $Q = f(s)$  shows the relationship between the volume flow  $Q$  in the installed valve and the stroke  $s$ . The properties of the pipelines, pumps and consumers are included in this characteristic. The operating characteristic therefore has a different shape than the flow characteristic.

For positioning applications of controllers, special requirements are often placed on the operating characteristic, e.g. linearity. For this reason, it is occasionally necessary to correct the operating characteristic in an appropriate manner. The Type 3360 and 3361 control valve thus has a transmission joint that realises various characteristics. These characteristics are used to correct the operating characteristic.

Equipercentile characteristics 1:25, 1:33, 1:50, 25:1, 33:1 and 50:1 as well as a linear characteristic can be set. In addition, it is possible to program a user-defined characteristic by entering supporting points.

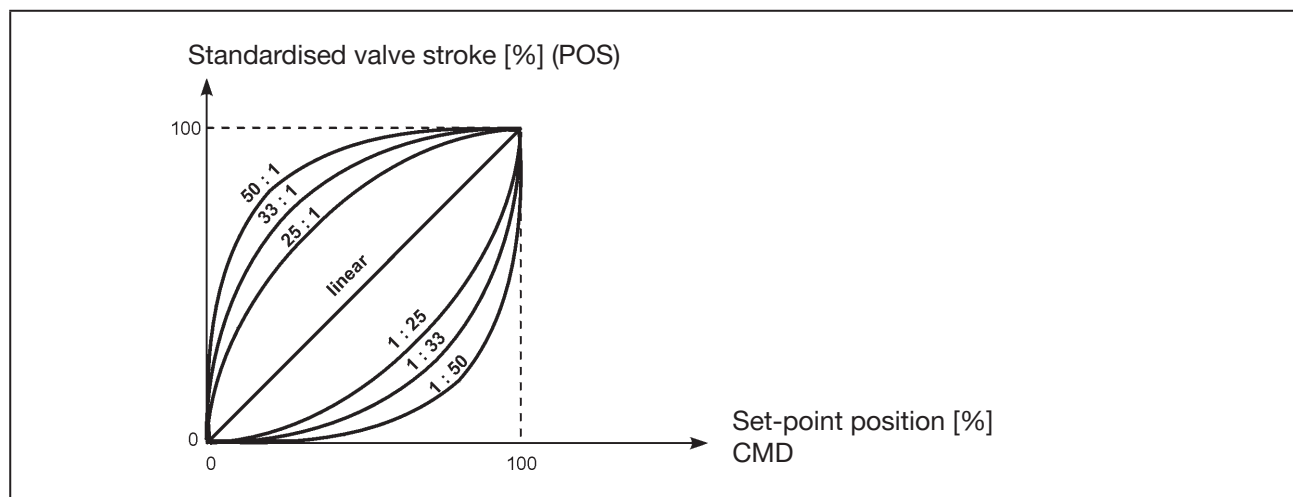

Fig. 51: Characteristics

### 14.3.1 Enabling or disabling correction characteristic in devices without a display module



The correction characteristic must be selected for enabling. For a description see chapter “14.3.3 Select correction characteristic or program to be user-specific”.

DIP switch 2, which is located under the blind cover, is used to activate the correction characteristic.



**Devices with ATEX approval or IECEx approval are secured with a magnetic lock.**

The removal of the cover is described in the supplementary instructions for the electromotive control valves with ATEX approval and IECEx approval.

→ To unlock the blind cover, turn it counterclockwise and remove

→ Set DIP switch 2 to ON. The correction characteristic is now enabled.

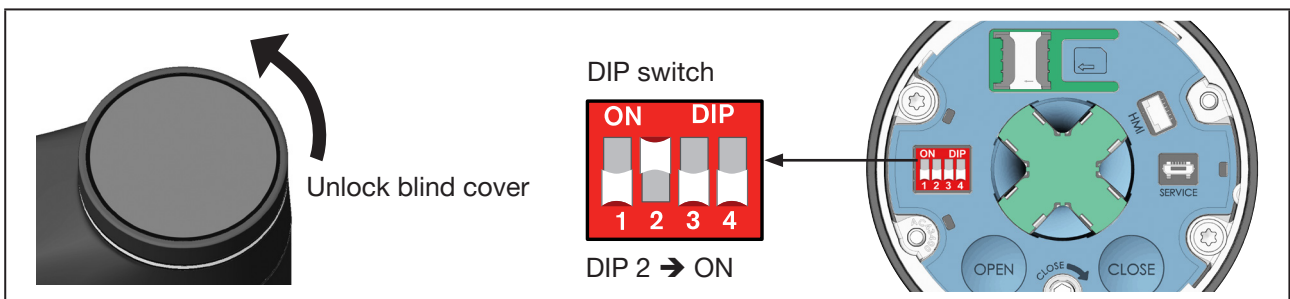

Fig. 52: Activate the correction characteristic

→ Close the blind cover.

### 14.3.2 Enabling or disabling correction characteristic in devices with a display module

To enable or disable the correction characteristic you must switch to the detailed view “Parameter for position controller”.

How to switch from the home screen to the detailed view:

→ switch to **CONFIGURATION**

→ select **Position controller** and confirm selection.

✔ You are now in the “Parameter” detailed view.

How to enable the correction characteristic:

→ select **ADD.FUNCTION** and confirm.

→ Select **CHARACT**, enable with the side navigation buttons and confirm.

The device returns to the “Parameter” detailed view.

The correction characteristic is enabled and the menu **CHARACT** for configuration is now available in the “Parameter” detailed view.

### 14.3.3 Select correction characteristic or program to be user-specific





#### Setting option:

Using the Bürkert Communicator software or the display of the device (optional).

Settings are created on the PC using the büS service interface and the Bürkert Communicator software. It requires the USB büS interface set available as an accessory.

Display operation: button functions

	Select, activate		Confirm		Back
---	------------------	---	---------	---	------

To program the correction characteristic you must switch to the “Parameter for position controller” detailed view.

#### How to switch to detailed view:

- When using Bürkert Communicator for the configuration, select **Position Controller** in the navigation area.
- When using the display for the configuration, switch to **CONFIGURATION** on the home screen and select **Position controller**.

#### How to select the correction characteristic:

- Select **CHARACT** in the “Parameter” detailed view.
- Confirm **TYPE**.
- Select correction characteristic.

✔ You have selected the correction characteristic.

#### How to configure the user-defined correction characteristic:

if the correction characteristic **User-defined** was selected in the **TYPE** menu, the **TABLE DATA** menu appears. The correction characteristic can be programmed therein as described below:

- select **TABLE DATA**.
- Select desired reference point **y 0** – **y 100**.
- Enter desired per cent value.
- Enter the per cent in succession for all reference points.
- Leave the **TABLE DATA** menu.

✔ You have programmed the correction characteristic.

## 14.4 Change effective direction

**Factory setting:** The effective direction “Rise” is set in devices on delivery.

Meaning:

- Rise: The position 0% (valve closed) is actuated with the standard signal 0 V, 0 mA or 4 mA.
- Fall: The position 0% (valve closed) is actuated with the standard signal 5 V, 10 V or 20 mA.

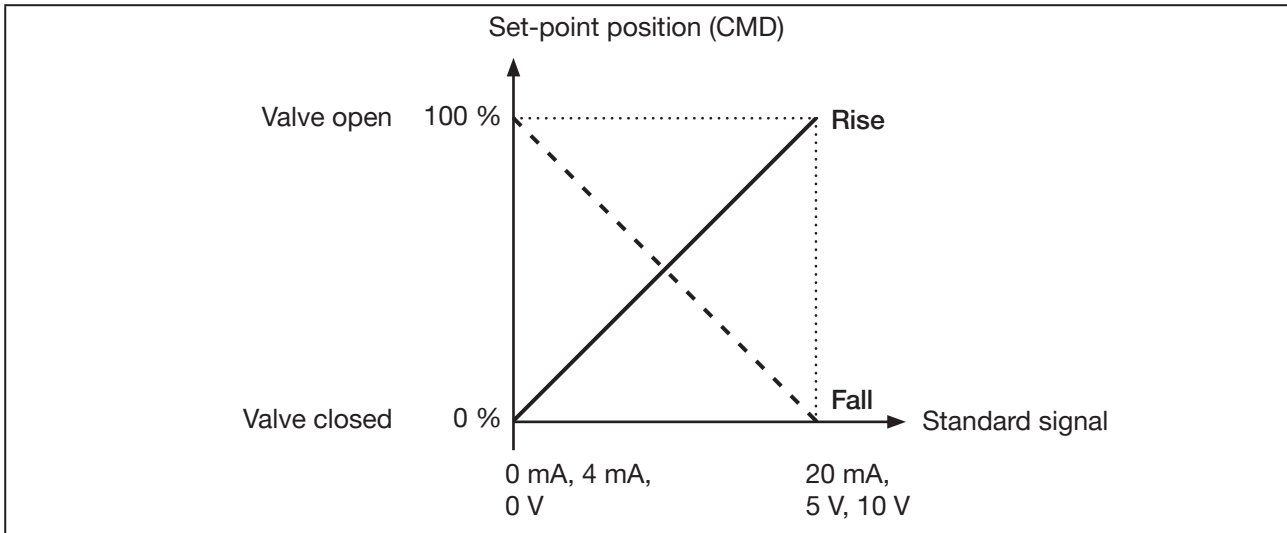

Fig. 53: Effective direction diagram

### 14.4.1 Changing effective direction in devices without a display module

The effective direction is changed with DIP switch 1, located below the blind cover.



**Devices with ATEX approval or IECEx approval are secured with a magnetic lock.**

The removal of the cover is described in the supplementary instructions for the electromotive control valves with ATEX approval and IECEx approval.

→ To unlock the blind cover, turn it counterclockwise and remove.

→ Set DIP switch 1 to ON. The effective direction is switched to “Fall”.

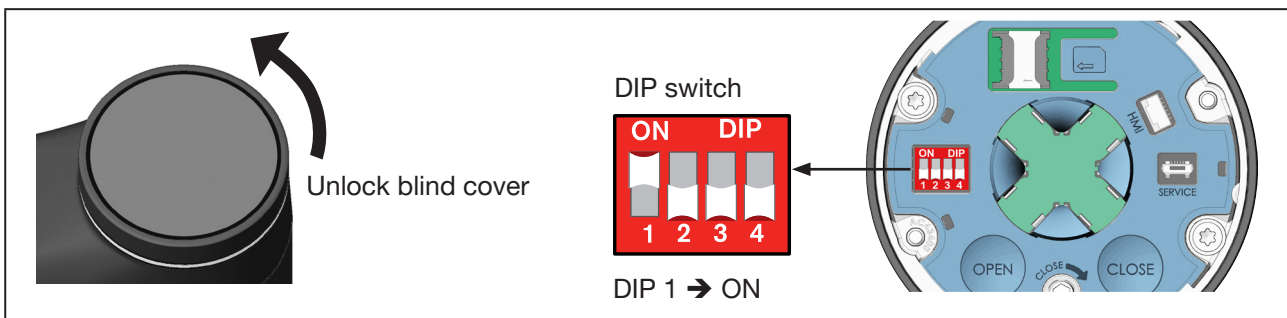

Fig. 54: Change effective direction

→ Close the blind cover.

## 14.4.2 Changing effective direction in devices with a display module

To change the effective direction, you must switch to the “Parameter for position controller” detailed view.

How to switch from the home screen to the detailed view:



→  switch to **CONFIGURATION**

→   select **Position controller** and  confirm selection.

✔ You are now in the “Parameter” detailed view.

How to change the effective direction:

→  select **ADD.FUNCTION** and  confirm.

→  Select **DIR.DMD**, enable with the side navigation buttons  and  confirm.

The device returns to the “Parameter” detailed view.

The menu for changing effective direction **DIR.DMD** is now enabled and available in the “Parameter” detailed view.

→ In the “Parameter” detailed view , select **DIR.CMD** and  confirm.

→  Select effective direction **Rise** or **Fall** and  confirm.

→ Return with .

✔ You have changed the effective direction.

## 14.5 Disabling process control

For devices with a process control function, the process control can be disabled in order to operate the device with the position controller function. The menus that are solely relevant to process control remain visible after disabling, but cannot be used.



### Required configuration after disabling process control.

The source for the set-point position must be configured for the position controller function. Configuration in menu → **Inputs/outputs** → **SP I CMD** → **CMD.source**.

### 14.5.1 Disabling process control in the device operating menu

The process control is generally disabled in the device operating menu, or via the digital input, büS/ CANopen or fieldbus.



#### Setting option:

Using the Bürkert Communicator software or the display of the device (optional).

Settings are created on the PC using the büS service interface and the Bürkert Communicator software. It requires the USB büS interface set available as an accessory.

Display operation: button functions

  Select, activate	 Confirm	 Back
--	--	---

To scale process control, switch to the “Parameters” detailed view for process controllers.

#### How to switch to detailed view:

→ When using Bürkert Communicator for the configuration, select **Process Controller** in the navigation area.

→ When using the display for the configuration, switch to **CONFIGURATION** on the home screen and select **Process Controller**.

✓ You are now in the “Parameter” detailed view.

#### How to disable process control:

→ select **P.CO.inactive**.

→ Select **P.CONTROL inactive**.

✓ The process control is now disabled. The device is now working with position controller function.

### 14.5.2 Alternative disabling of process control

Alternatively, the process control can be disabled via the digital input, büS/CANopen or fieldbus. The source must be configured accordingly.

To configure the source, you must switch to the detailed view “Parameter for **inputs/outputs**”.

Configuration in menu → **ADDITIONAL IOs** → **DIGITAL IN** → **X.CO I P.CO.source**,

Selection:

→ **Digital** (digital input)

→ **büS**

→ **Fieldbus** (fieldbus)



## 15 MANUAL OVERRIDE OF VALVE

The valve can be manually actuated in various ways:

- Electrically with the OPEN and CLOSE buttons which are located under the blind cover (only on devices without display module), see chapter “15.1” on page 113.
- Electrically using the display on the home screen (only on devices with a display module), see chapter “15.2.1” on page 115.
- Electrically in the AUTO | MANU menu. Setting on the display or using the Bürkert Communicator software, see chapter “15.3” on page 116.
- Mechanically with the manual override, see chapter “15.4” on page 117.

### 15.1 Electrical override of valve on devices without a display module

The valve can be electrically actuated in various ways:

- with buttons in the device, see chapter “15.1.1” on page 113.
- Using the Bürkert Communicator software in the **AUTO | MANU** menu. For a description see chapter “15.3” on page 116.

#### 15.1.1 Electrically actuating the valve using keys in the device

##### NOTE!

Valve seat seal may be damaged as a result of electrical manual override.

- ▶ Do not press the CLOSE button while the valve is closed or else the valve seat seal may be damaged.

To actuate the valve, the device must be in MANUAL operating state.

The 2 buttons for actuating the valve and for setting the mode are located under the blind cover.

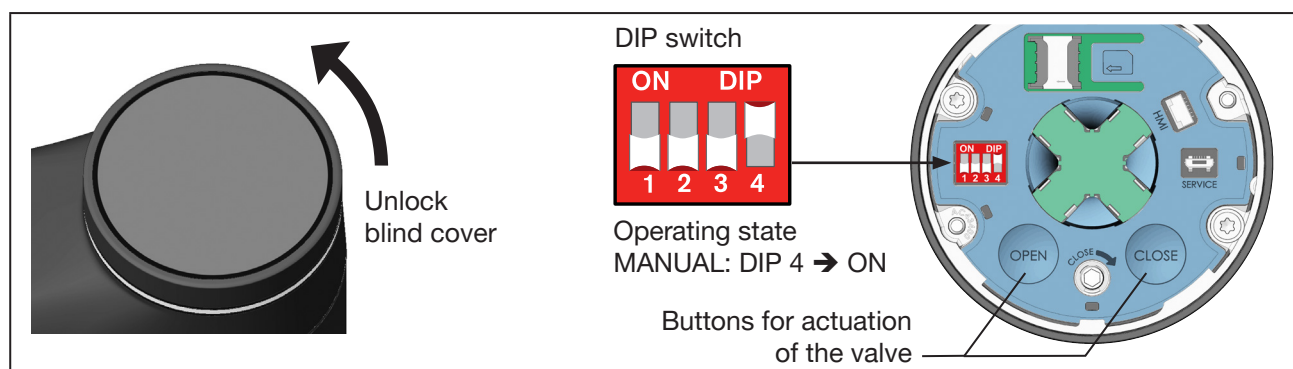

Fig. 55: Set MANUAL operating state and actuate valve

**Remove the blind cover:**



**Devices with ATEX approval or IECEx approval are secured with a magnetic lock.**

The removal of the cover is described in the supplementary instructions for the electromotive control valves with ATEX approval and IECEx approval.

→ To unlock the blind cover, turn it counterclockwise and remove.

**Switch to MANUAL operating state:**

→ Set DIP switch 4 to ON.

The device is in MANUAL operating state.

**Change valve position:**

→ To open, press the OPEN button

→ To close, press the CLOSE button.

**NOTE!**

Do not press the CLOSE button again while the valve is closed or else the valve seat seal may be damaged.

The valve position is to be detected on the mechanical position indicator.

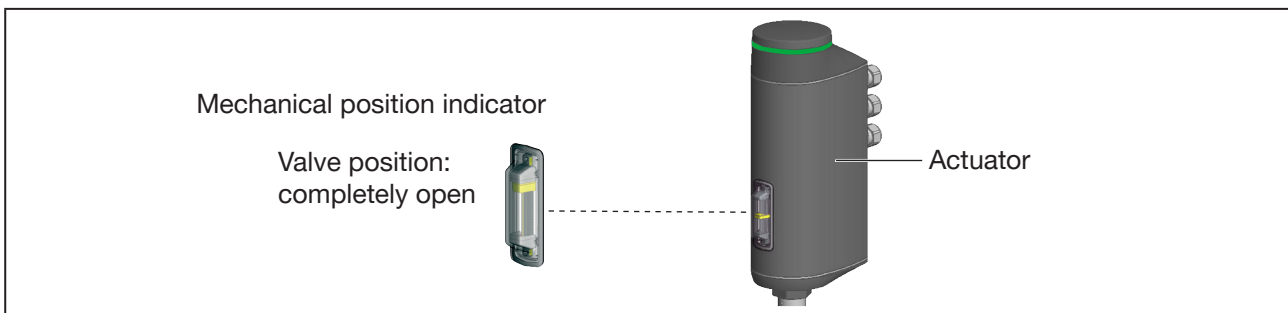

Fig. 56: Mechanical position indicator

**Switch to AUTOMATIC operating state:**

→ Push DIP switch 4 down.

The device is back in AUTOMATIC operating state.

**Close blind cover:**

→ Mount blind cover and turn clockwise until the 2 marks (one vertical line on the blind cover and on the actuator) are vertically aligned.

## 15.2 Electrical override of valve on devices with a display module

The valve can be electrically actuated in various ways:

- Using the navigation keys on the display (see chapter “15.2.1” on page 115).
- On the display or using the Bürkert Communicator software in the **AUTO I MANU** menu. For a description see chapter “15.3” on page 116.

### 15.2.1 Actuating the valve using the navigation keys on the display

#### NOTE!

Valve seat seal may be damaged as a result of electrical manual override.

- ▶ Do not press the CLOSE button while the valve is closed or else the valve seat seal may be damaged.

The navigation keys for actuating the valve are available in the home screen or in a view. Requirements for actuation of the valve (see “Fig. 57”):

- View of the display in the Process Control layout,
- MANUAL operating state.



#### Setting the layout:

The layout is set in the context menu: To open the context menu, hold down the menu button .

#### Process Control factory setting:

The Process Control layout is pre-defined in factory settings for the home screen (factory designation: View 1...).

To access the home screen, hold down the  back key.

See also chapter “13.3 Display views” on page 93.

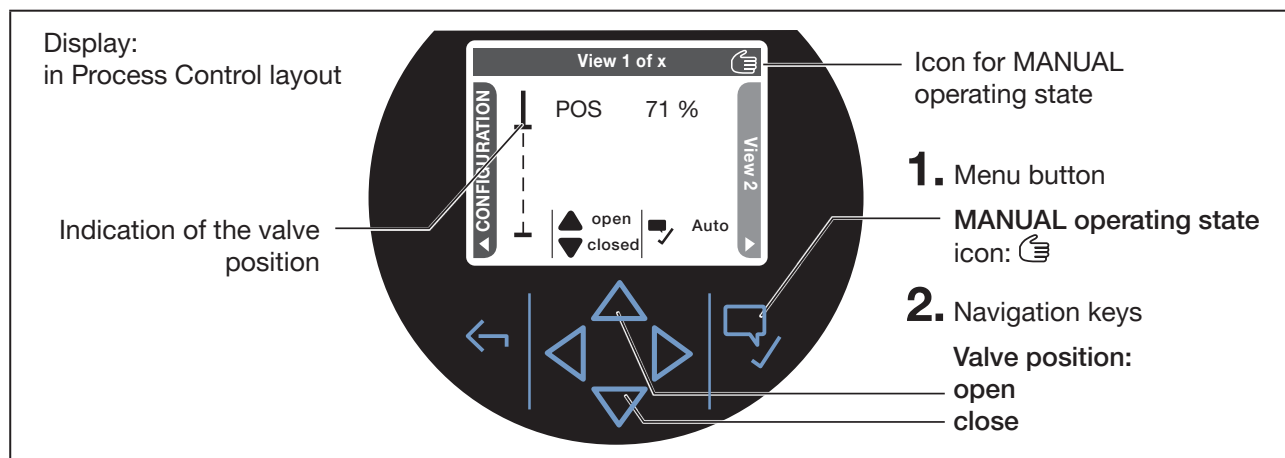





Fig. 57: On the display set the mode and actuate the valve

**Switch to MANUAL operating state:**

-  Press the menu button.  
In MANUAL operating state, the MANUAL icon  is visible in the information bar.  
The two arrow icons labelled “open” and “close” are displayed. The device’s LED light ring flashes.

**Change valve position:**

- To open the valve,  press the top navigation key.
- To close the valve,  press the bottom navigation key.  
**NOTE!** Do not press the CLOSE button again while the valve is closed or else the valve seat seal may be damaged.

The valve position is shown on the display (see “Fig. 57”).

**Switch to AUTOMATIC operating state:**

- To switch to AUTOMATIC operating state, briefly press the  menu button.

## 15.3 Electrically actuating the valve using the Bürkert Communicator or display

**NOTE!**



Valve seat seal may be damaged as a result of electrical manual override.

- ▶ Do not press the CLOSE button while the valve is closed or else the valve seat seal may be damaged.

Both the Bürkert Communicator software as well as the device software provide the additional option to actuate the valve using the **AUTO | MANU** menu.

 For the setting using the Bürkert Communicator software, the device must be connected to the PC using the büS service interface. It requires the USB-büS-Interface set available as an accessory.

Display operation: button functions

 Select, activate	 Confirm	 Back
--	---	--

**Actuate the valve using the **AUTO | MANU** menu:**

To configure, you must switch to the detailed view “Maintenance for general settings”.

How to switch to detailed view:

- When using Bürkert Communicator for the configuration, select **General settings** in the navigation area and switch to **MAINTENANCE**.
- When using the display for the configuration, switch to **CONFIGURATION** on the home screen, select **General settings** and switch to **MAINTENANCE**.
- ✔ You are now in the “Maintenance” detailed view.

How to open or close the valve:

→ select **AUTO | MANU**.

If the device is in AUTOMATIC operating state:

→ select **Manual mode** to set MANUAL operating state.

The **Manual mode** menu for manual actuation of the valve is now available.

→ In the **Manual mode** menu, open and close the valve with the arrow buttons.

**NOTE!**

Do not press the CLOSE button again while the valve is closed or else the valve seat seal may be damaged.

## 15.4 Actuating the valve mechanically

If there is no supply voltage, e.g. during installation or in the event of a power failure, the valve can be opened or closed using the mechanical manual override.

**NOTE!**

The mechanical manual override may be used only when it is de-energised, otherwise the device may be damaged.



Devices with ATEX approval or IECEx approval are secured with a magnetic lock.

The removal of the cover is described in the supplementary instructions for the electromotive control valves with ATEX approval and IECEx approval.

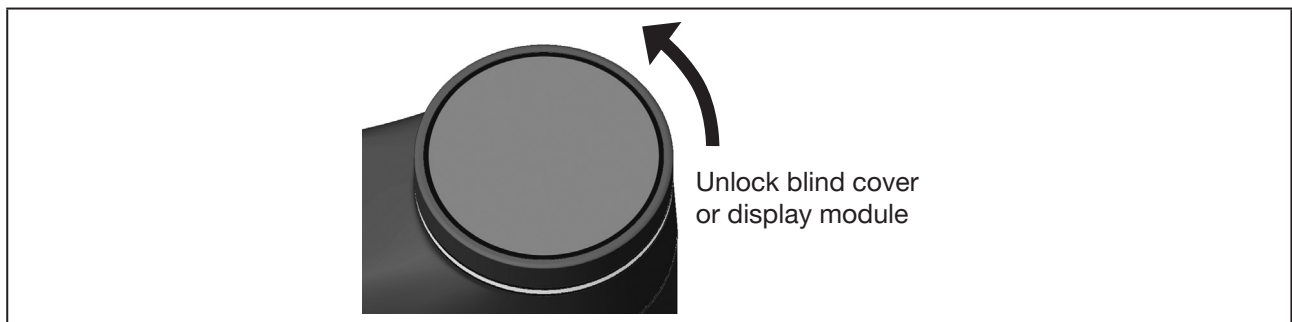

Fig. 58: Remove the blind cover from the actuator housing

### 15.4.1 Required work steps

1. Switch off the supply voltage. Wait until LED illuminated ring goes out.
2. AG2: Remove blind cover or display module.  
AG3: Unscrew the pressure compensation element (AF 17).  
2a. Only for devices with fieldbus gateway: Remove fieldbus gateway from the actuator (see chapter [“15.4.2”](#)).
3. Actuate valve mechanically.
4. AG2: Close the blind cover or display module.  
AG3: Screw on the pressure compensation element (AF17) to 1.25 Nm.  
4a. Only for devices with fieldbus gateway: first install fieldbus gateway on the actuator (see chapter [“15.4.5”](#)), then seal blind cover or display module (see chapter [“15.4.6”](#)).

5. Connect supply voltage.

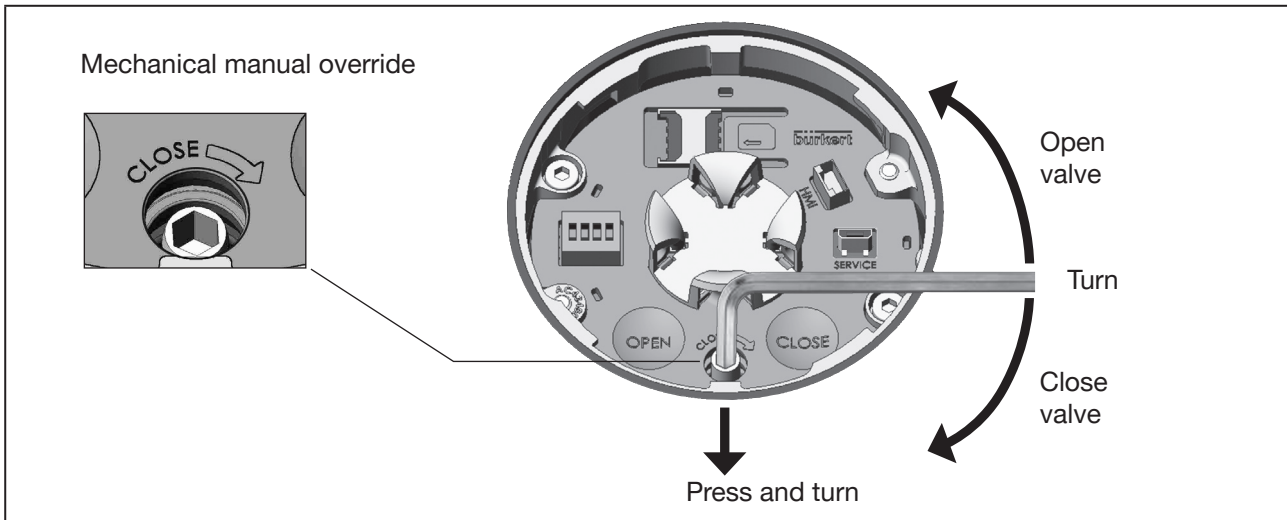

Fig. 59: Mechanical manual override AG2

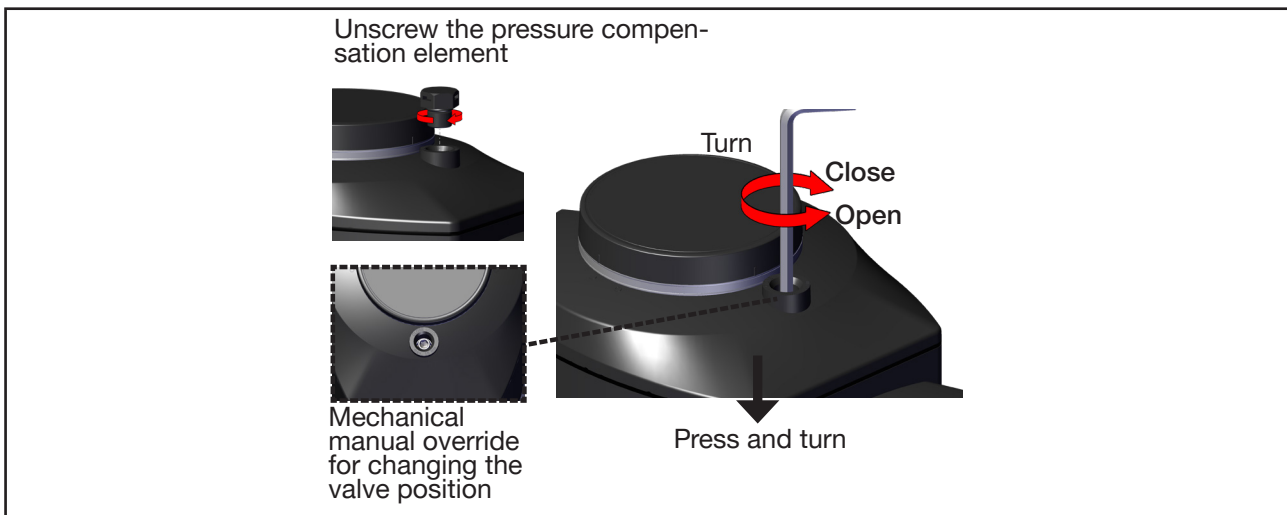

Fig. 60: Mechanical manual override AG3

**Remove blind cover or display module:**

**!** Devices with ATEX approval or IECEx approval are secured with a magnetic lock. The removal of the cover is described in the supplementary instructions for the electromotive control valves with ATEX approval and IECEx approval.

**NOTE!**

Carefully remove the display module so that the connection cable and HMI interface are not damaged.

→ To unlock, turn the display module or the blind cover counterclockwise and remove.

**!** For devices with display module, take note of the connection cable to the HMI interface.

### Actuating valve mechanically:

→ To operate the valve mechanically, use an Allen key with width across flats of 3 mm (AG2)/5 mm (AG3).

### NOTE!

**Maximum torque 2 Nm (AG2)/10 Nm (AG3).** Exceeding the torque when the valve end position is reached will damage the mechanical manual override or damage the device.

→ Apply light pressure to lock the mechanical manual override mechanism into place while turning the Allen key at the same time (see “Fig. 59” and “Fig. 60”).

- ⚠ Maximum tightening torque 2 Nm (AG2)/10 Nm (AG3)!
- Turn counterclockwise to open.
  - Turn clockwise to close.

The position indicator shows that the valve end positions have been reached (see “Fig. 61”).

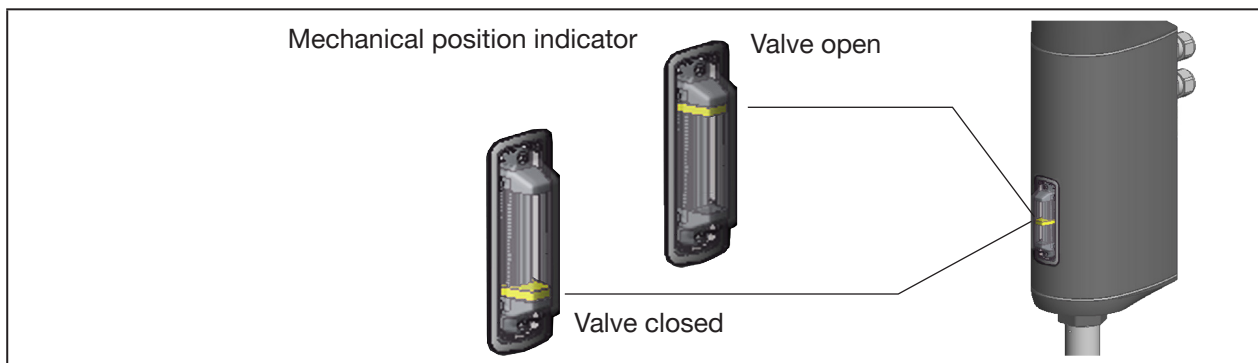

Fig. 61: Mechanical position indicator

→ Once the desired valve position is achieved, remove the Allen key.  
The mechanical manual override mechanism will disengage automatically.

### Close the blind cover or display module:

### WARNING!

**For devices with display module**  
Before mounting the display, check whether the cable is correctly connected to the HMI interface.

→ Mount blind cover or display module and turn clockwise until the 2 marks (one vertical line on the blind cover and on the actuator) are vertically aligned.

## 15.4.2 Removing the fieldbus gateway from the actuator (AG2)

### Prerequisites:

Supply voltage switched off, blind cover or display module removed.

### WARNING!

The fieldbus gateway may be removed only when it is deenergised, otherwise the device may be damaged.

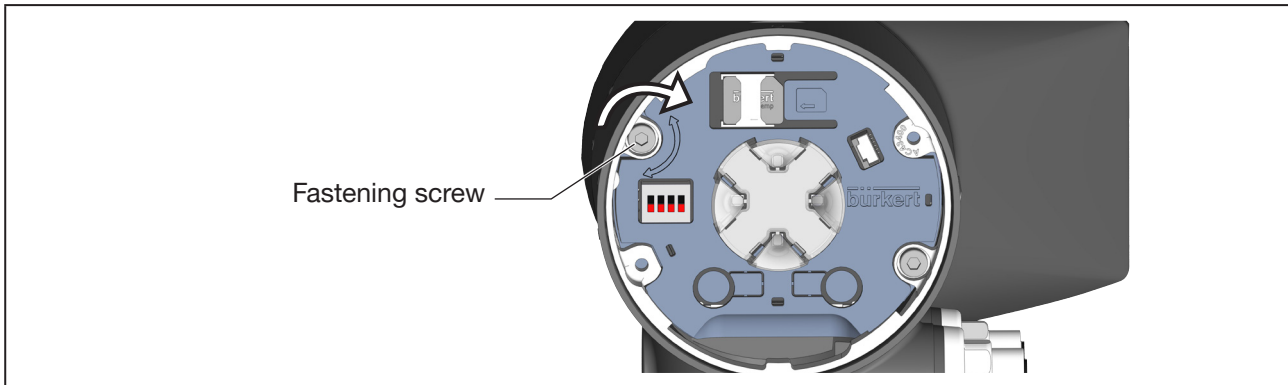

Fig. 62: Remove fieldbus gateway

→ Remove fastening screw (socket head screw, width across flats 3 mm).

### NOTE!

Caution when removing the fieldbus gateway. Fieldbus gateway and actuator are connected to each other by a cable.

→ To release the fieldbus gateway, turn it counterclockwise and carefully remove it.

→ Disconnect connection cable from the fieldbus gateway.

## 15.4.3 Actuating valve mechanically AG2

### Prerequisites:

Supply voltage switched off, blind cover or display module removed. Also for device variant with fieldbus gateway: Fieldbus gateway removed.

### WARNING!

The mechanical manual override may be used only when it is de-energised, otherwise the device may be damaged.

→ To mechanically override the valve, use an Allen key with 3 mm AF.

### NOTE!

**Maximum torque 2 Nm.**

Exceeding this torque value upon reaching the end position of the valve may damage the mechanical manual override mechanism.



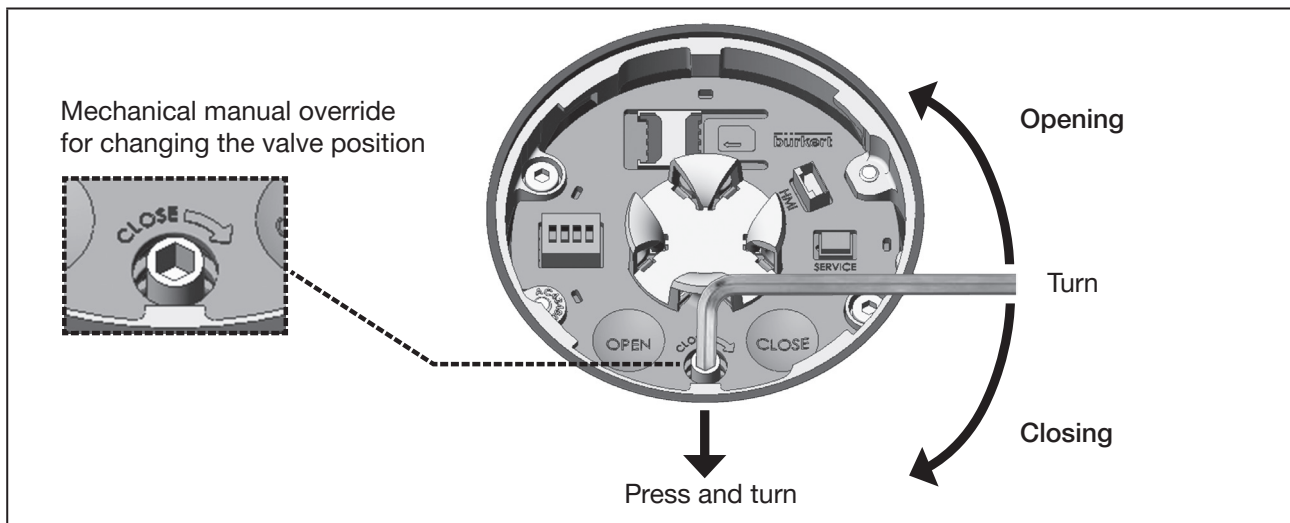

Fig. 63: Mechanical manual override

→ Apply light pressure to lock the mechanical manual override mechanism into place while turning the Allen key (see “Fig. 63”).

- ⚠ Maximum tightening torque 2 Nm
- Turn counterclockwise to open.
- Turn clockwise to close.

The valve position is to be detected on the mechanical position indicator.

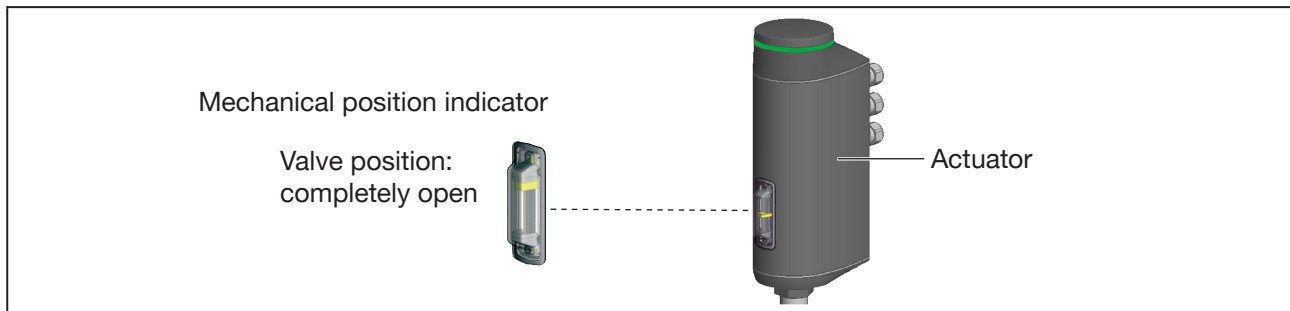

Fig. 64: Mechanical position indicator

→ Once the desired valve position is achieved, remove the Allen key.  
The mechanical manual override mechanism will disengage automatically.

#### 15.4.4 Actuating valve mechanically AG3

**Prerequisites:**

Supply voltage switched off, pressure compensation element unscrewed.

#### **WARNING!**

The mechanical manual override may be used only when it is de-energised, otherwise the device may be damaged.

→ To mechanically override the valve, use an Allen key with 5 mm AF.

**NOTE!**

**Maximum torque 10 Nm.**  
Exceeding this torque value upon reaching the end position of the valve may damage the mechanical manual override mechanism.

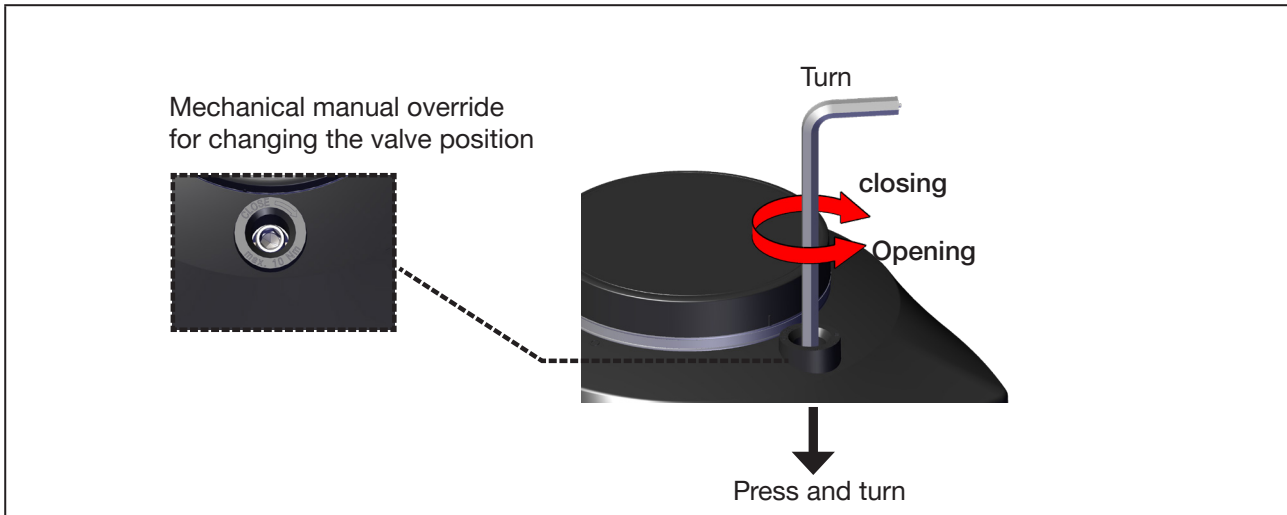

Fig. 65: Mechanical manual override

→ Apply light pressure to lock the mechanical manual override mechanism into place while turning the Allen key (see “Fig. 65”).

⚠ Maximum tightening torque 10 Nm!

- Turn anticlockwise to open.
- Turn clockwise to close.

The valve position is to be detected on the mechanical position indicator.

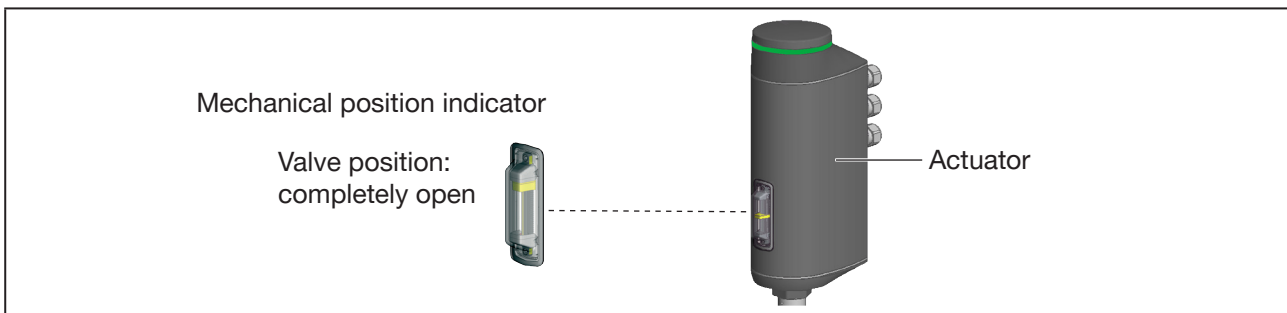

Fig. 66: Mechanical position indicator

→ Once the desired valve position is achieved, remove the Allen key.  
The mechanical manual override mechanism will disengage automatically.

### 15.4.5 Mount fieldbus gateway on the actuator (only AG2)

Prerequisites: supply voltage switched off.

**WARNING!**

The fieldbus gateway may be mounted only when it is deenergised, otherwise the device may be damaged.

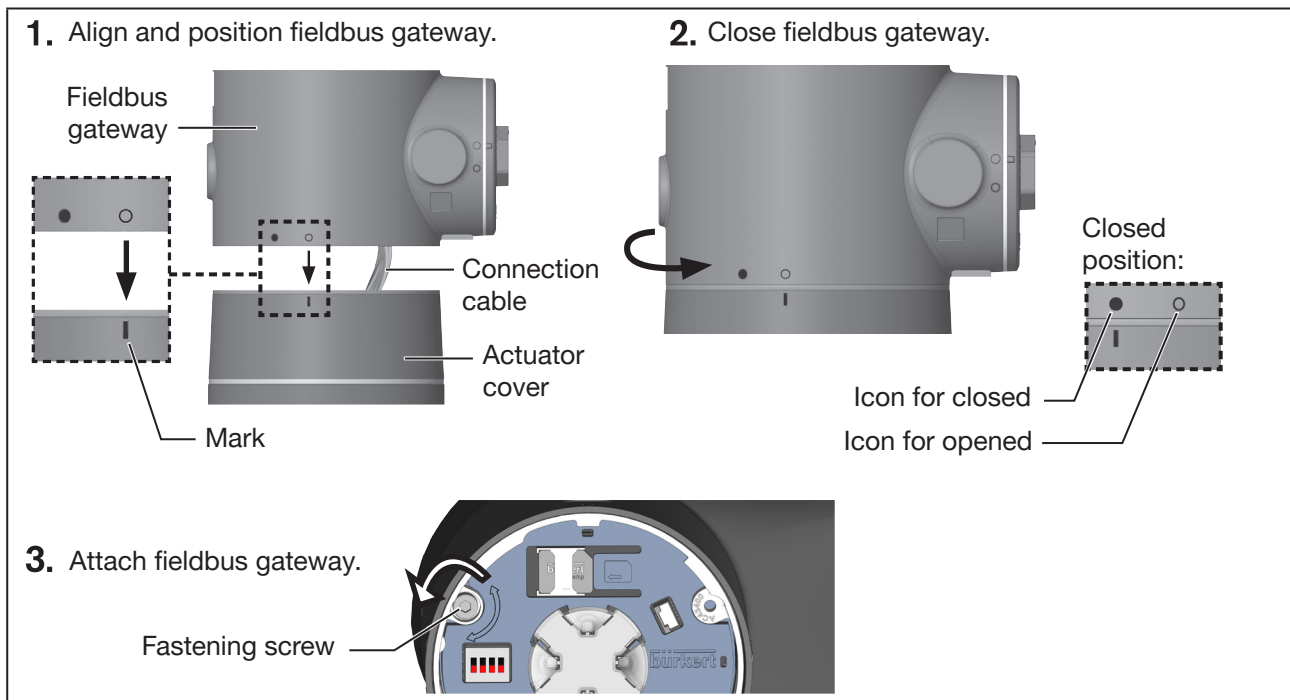

Fig. 67: Mounting fieldbus gateway:

- Insert connection cable into the actuator on the fieldbus gateway.
- Align and position fieldbus gateway on the actuator cover.  
Centre the icon for opened over the mark on the actuator.
- Manually turn fieldbus gateway clockwise until the icon for closed is positioned over the mark.
- Tighten fastening screw (socket head screw, width across flats 3 mm).  
Observe the tightening torque of 1.1 Nm!

#### 15.4.6 Close blind cover or display module (only AG2)



**Devices with ATEX approval or IECEx approval are secured with a magnetic lock.**

Closing the cover is described in the supplementary instructions for the electromotive control valves with ATEX approval and IECEx approval.

#### NOTE!

**For devices with display module**

Before mounting the display, check whether the cable is correctly connected to the HMI interface.

- Mount display module or the blind cover and turn it clockwise until the 2 marks are vertically aligned.  
Vertical lines are affixed as marks to the display module, blind cover and actuator.

## 16      **ADVANCED FUNCTIONS**

The functions for special control tasks and their configuration are described in a separate software description. These can be found, with specification on our homepage: [country.burkert.com](https://country.burkert.com)

## 17 OPERATING STRUCTURE AND FACTORY SETTING

The factory default settings are depicted in blue in the operating structure to the right of the menu.

- Examples:  /  Factory-enabled or selected menu options  
 /  Factory-disabled or unselected menu options  
 2%, 10 sec, ... Factory-set values

### 17.1 Operating structure of the configuration area

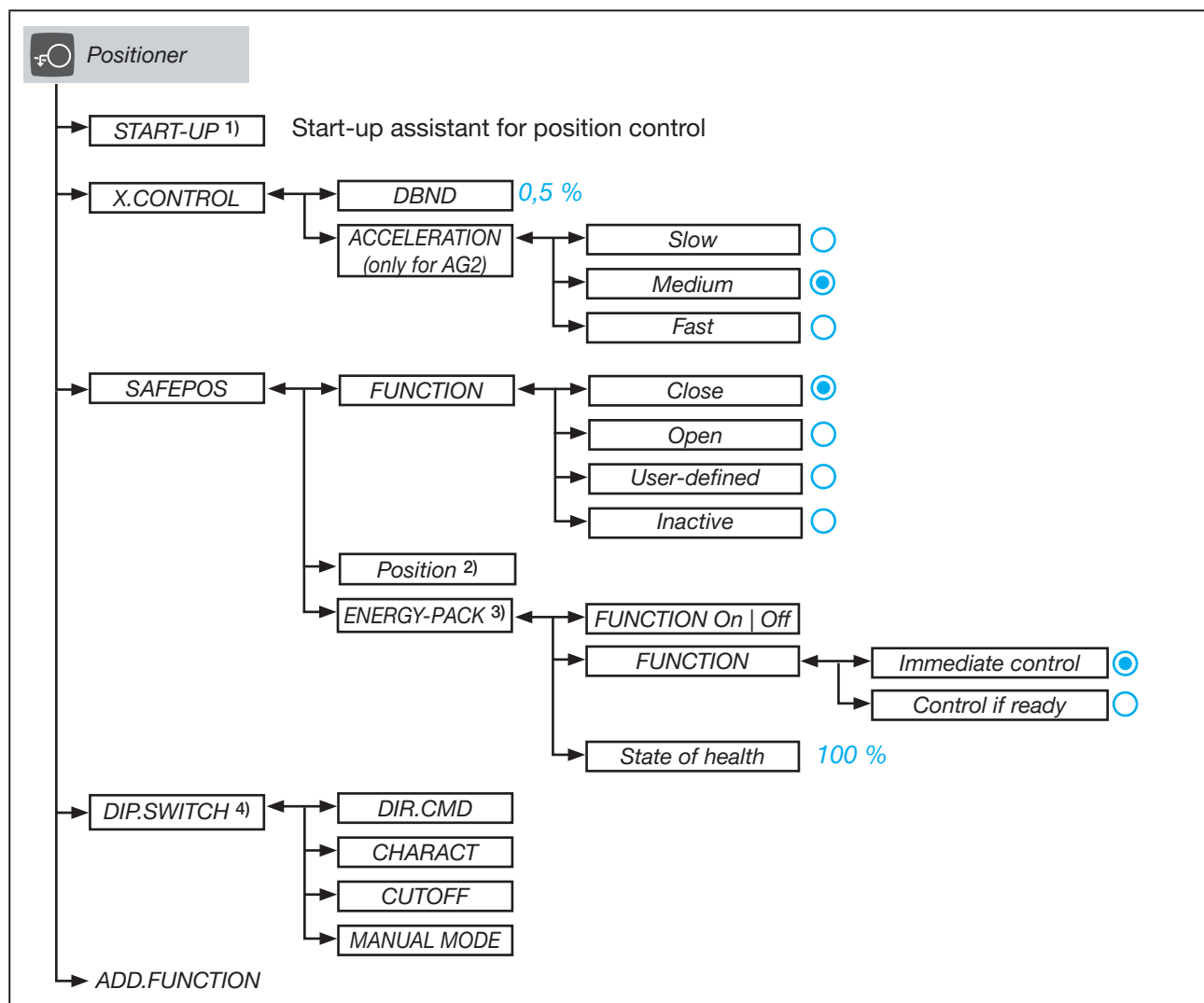

Fig. 68: Operating structure – 1-a, “Positioner” configuration area

- 1) Only available in devices without process controller function
- 2) Only available if selected in the menu **SAFEPOS** → **FUNCTION** → **User-Defined**.
- 3) Only available in devices with energy storage system SAFEPOS energy-pack (option).
- 4) Only available in the Bürkert Communicator software for devices without a display module.

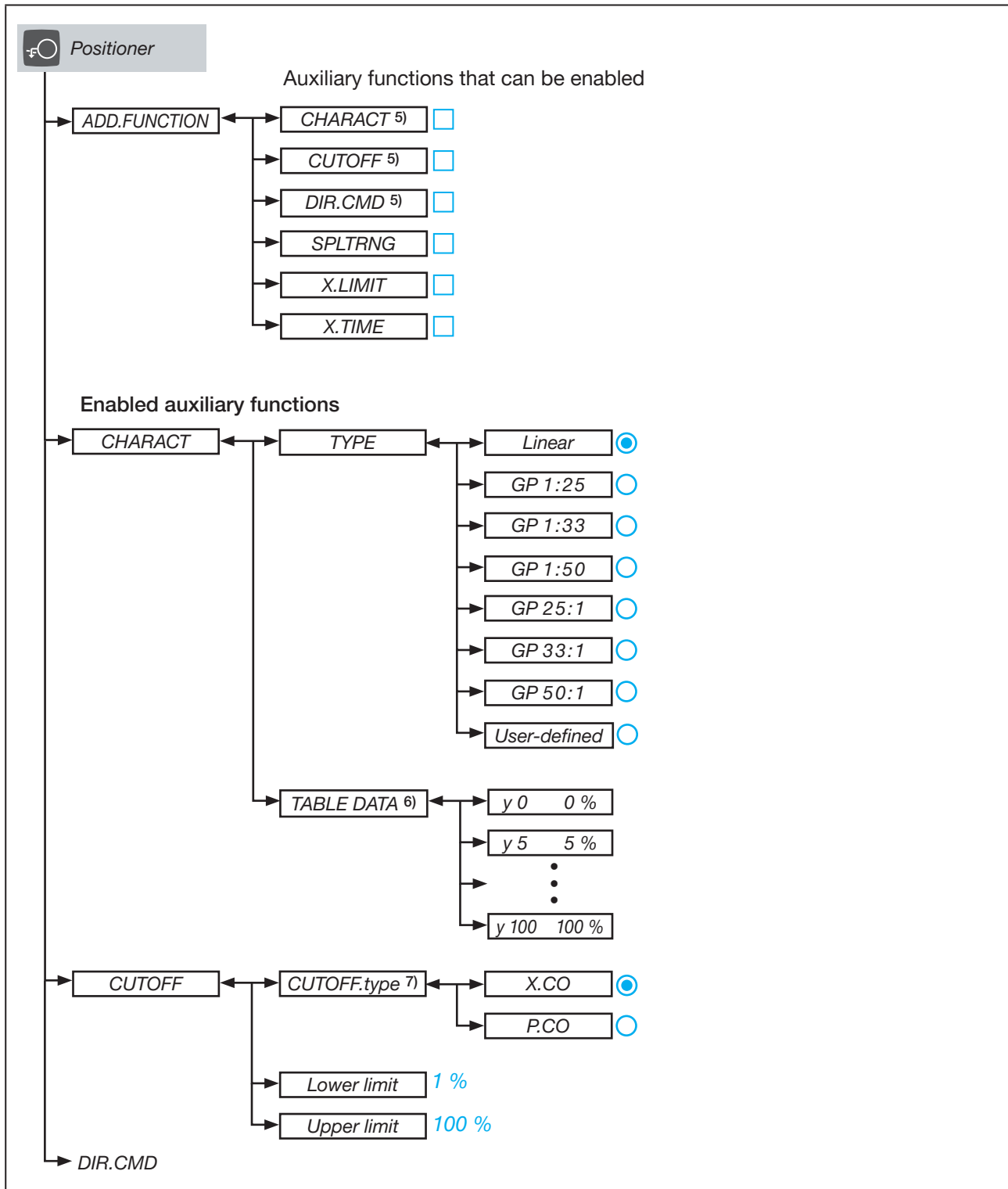

Fig. 69: Operating structure – 1-b, “Position controller” configuration area

5) For devices without a display, the menu is not enabled with **ADD.FUNCTION** but rather on the DIP switch of the device

6) Only available if selected in the menu **CHARACT** → **TYPE** → **User-Defined**.

7) Only available in devices with process control function.

MAN 1000274112 EN Version: H Status: RL (released | freigegeben) printed: 26.01.2023

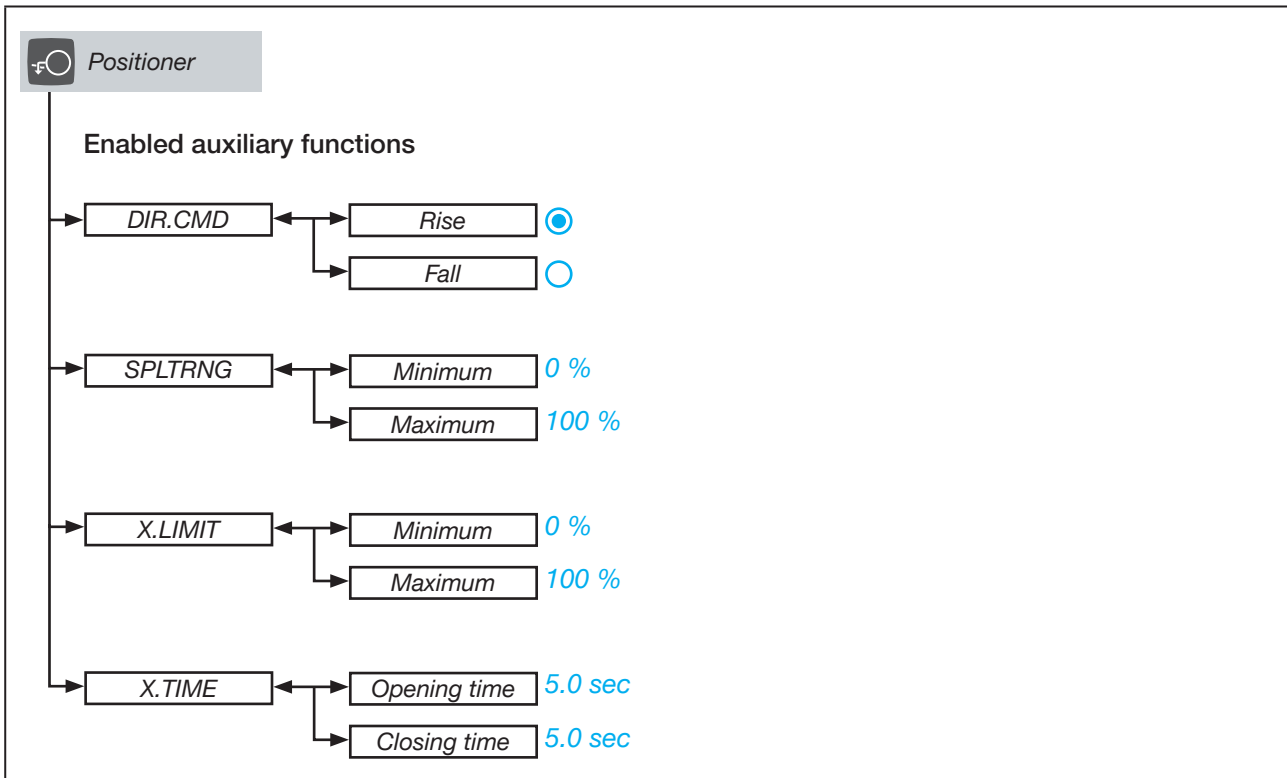

Fig. 70: Operating structure – 1-c, “Position controller” configuration area

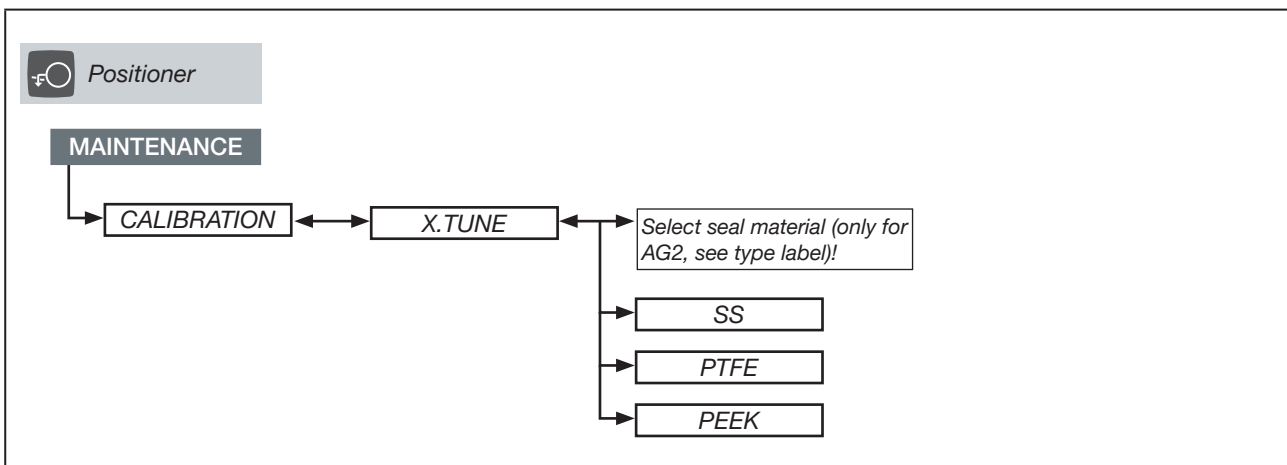

Fig. 71: Operating structure – 1-d, position controller maintenance

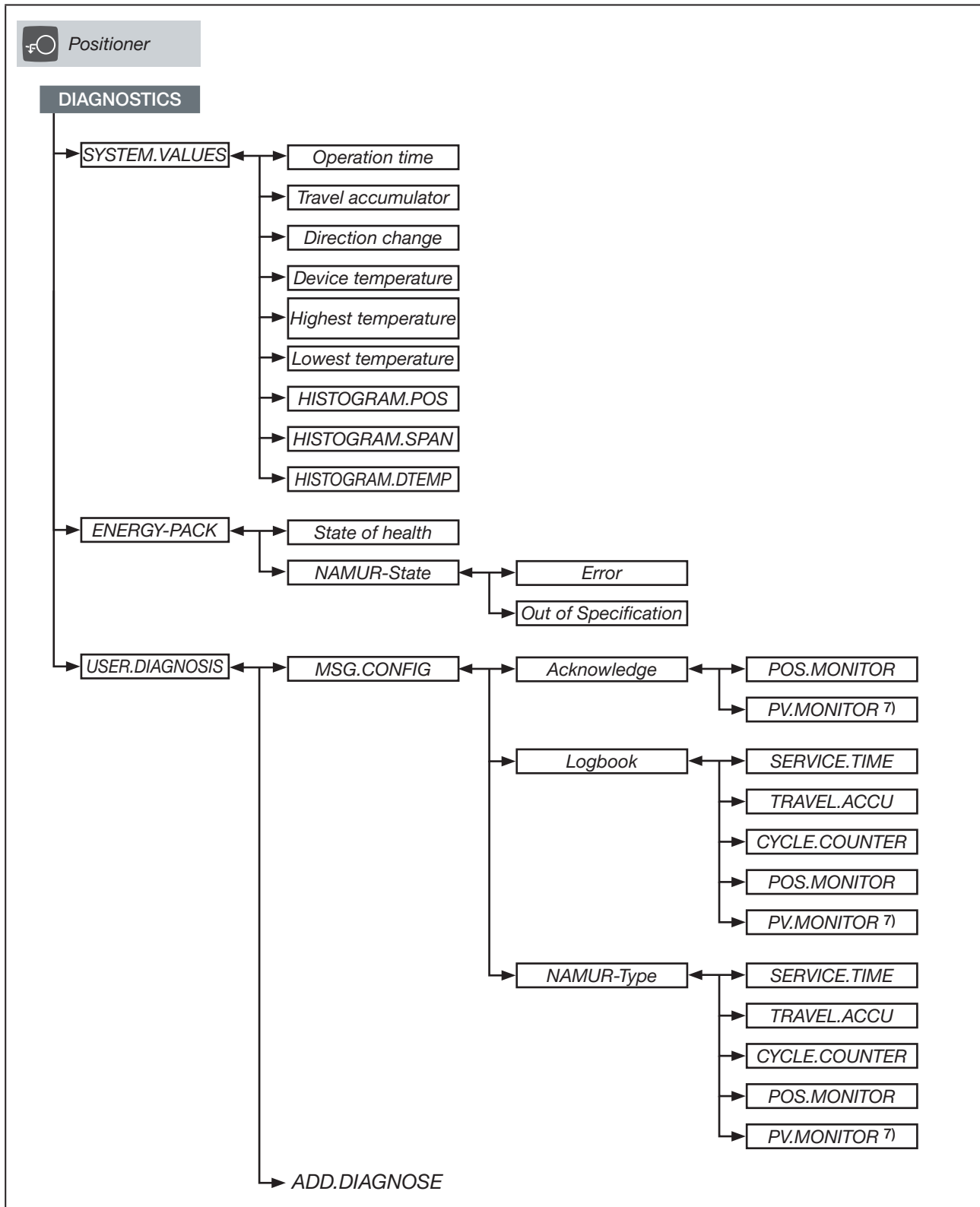

Fig. 72: Operating structure – 1-e, position controller diagnostics

7) Only available in devices with process control function.



MAN 1000274112 EN Version: H Status: RL (released | freigegeben) printed: 26.01.2023

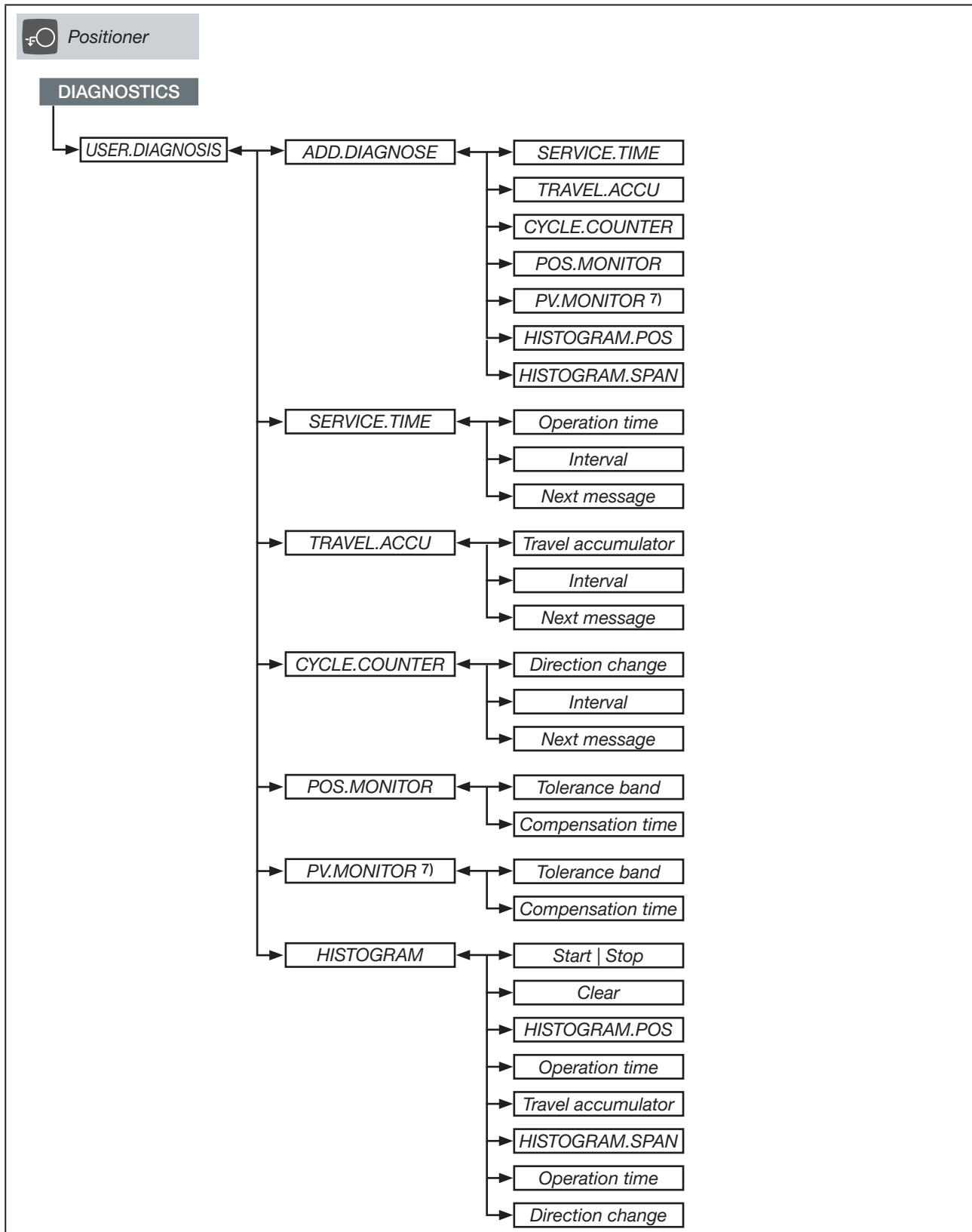

Fig. 73: Operating structure – 1-f, position controller diagnostics

7) Only available in devices with process control function.

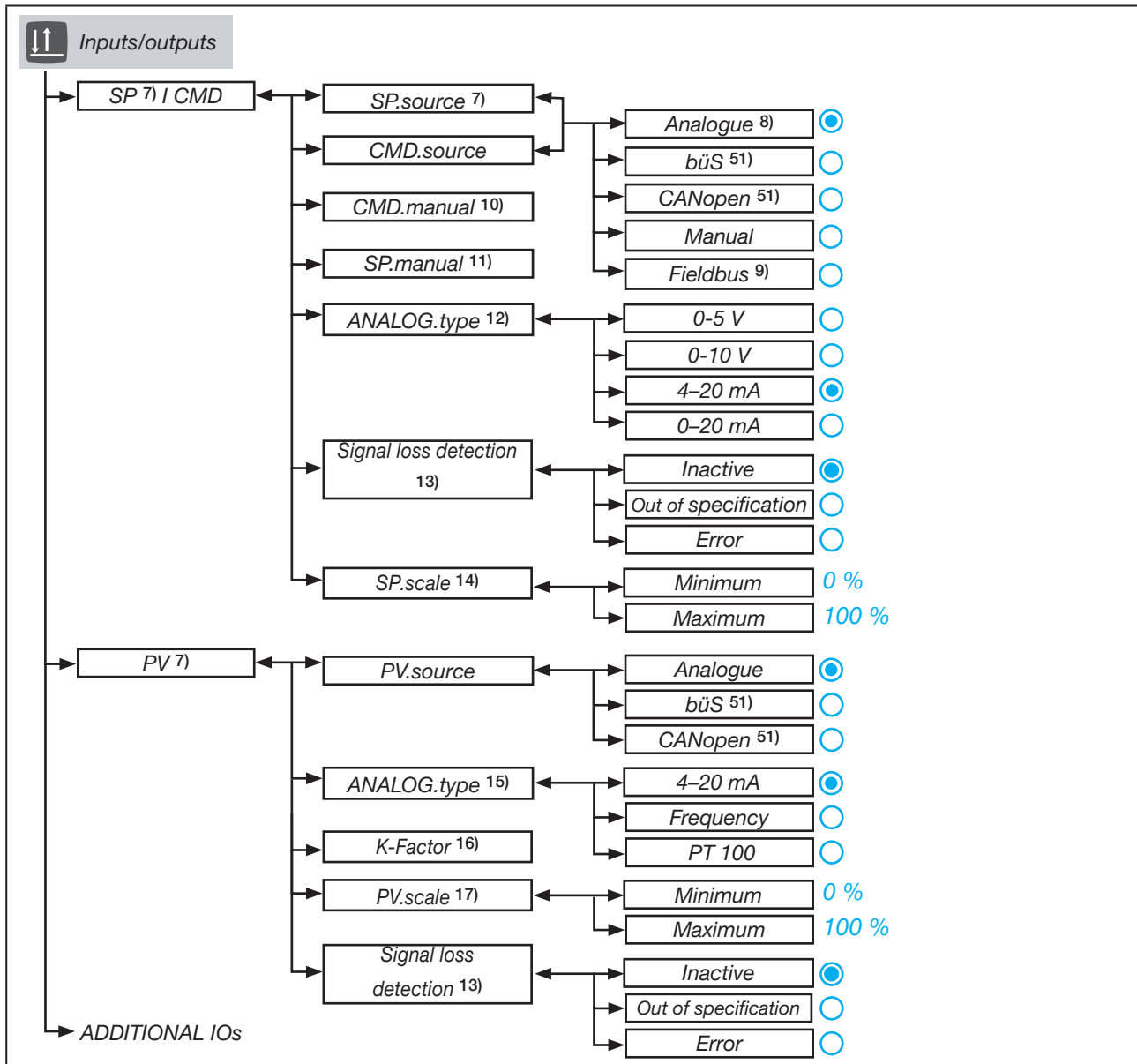

Fig. 74: Operating structure – 2-a, “Inputs/outputs” configuration area

7) Only available in devices with process control function.

8) Only available for corresponding device variant.

9) Only available for corresponding device variant.

10) Only available if selected in the menu **CMD.source** → **Manual**.

11) Only available in devices with process control function if selected in menu **SP | CMD** → **SP.source** → **Manual**.

12) Only available if selected in the menu **CMD.source** or in menu **SP.source** → **Analog**.

13) Only available if selected in submenu → **ANALOG.type** → **4-20 mA**.

14) Only available in devices with process control function if selected in menu **SP | CMD** → **SP.source** → **Analog**.

15) Only available if selected in the menu **PV.source** → **Analog**.

16) Only available if selected in the menu **PV** → **Analog.type** → **Frequency**.

17) Only available if selected in the menu **PV** → **Analog.type** → **4-20 mA**.

51) Only available for corresponding device variant.

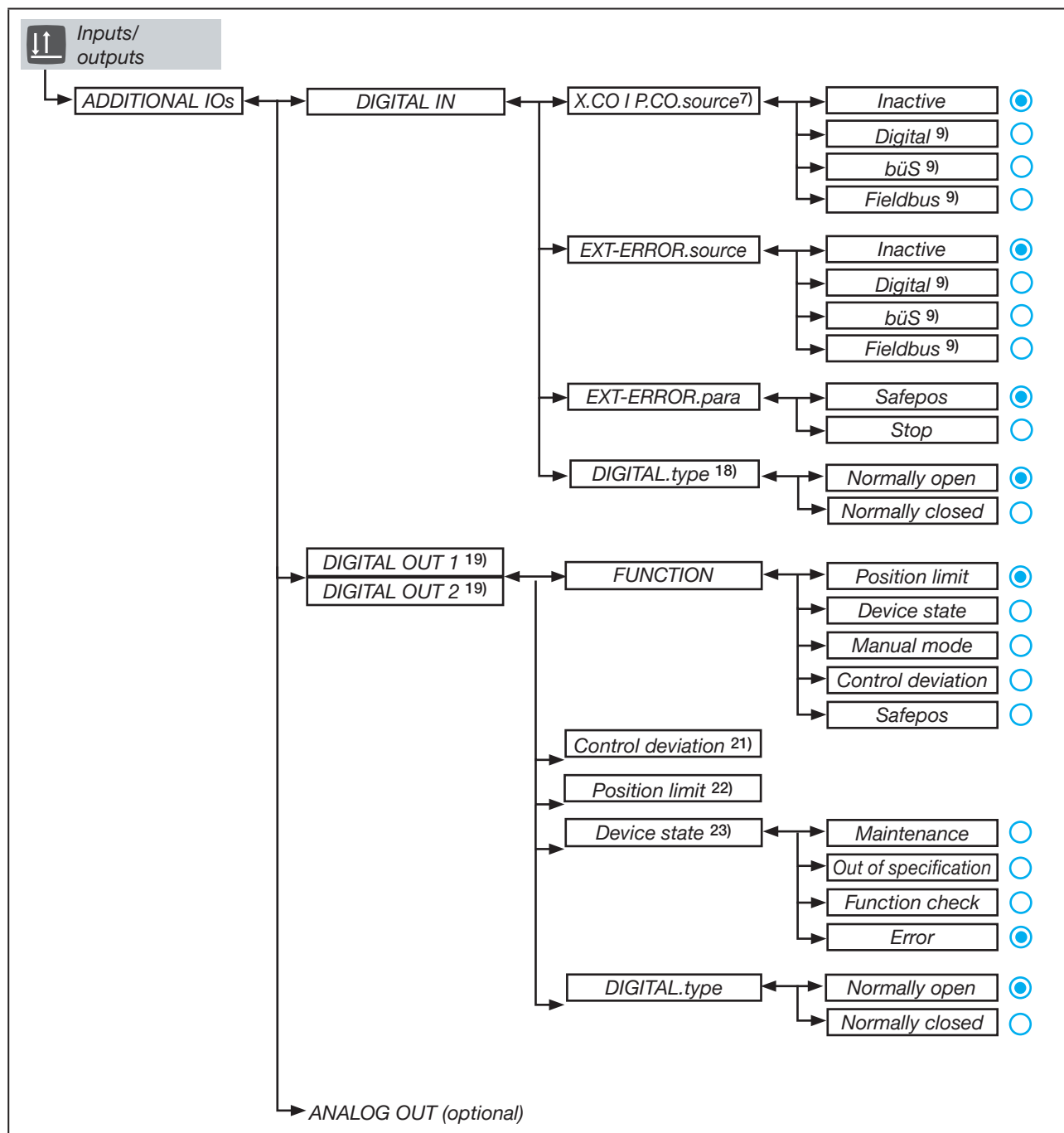

Fig. 75: Operating structure – 2-b, “Inputs/outputs” configuration area

7) Only available in devices with process control function

9) Only available for corresponding device variant.

18) Only available if selected in the menu **ADDITIONAL IO's** → **DIGITAL IN** → **X.CO | P.CO.source** or **EXT-ERROR.source** → **Digital**.

19) Only available in devices with digital output option.

21) Only available if selected in submenu **FUNCTION** → **Control Deviation**.

22) Only available if selected in submenu **FUNCTION** → **Position Limit**.

23) Only available if selected in submenu **FUNCTION** → **Device State**.

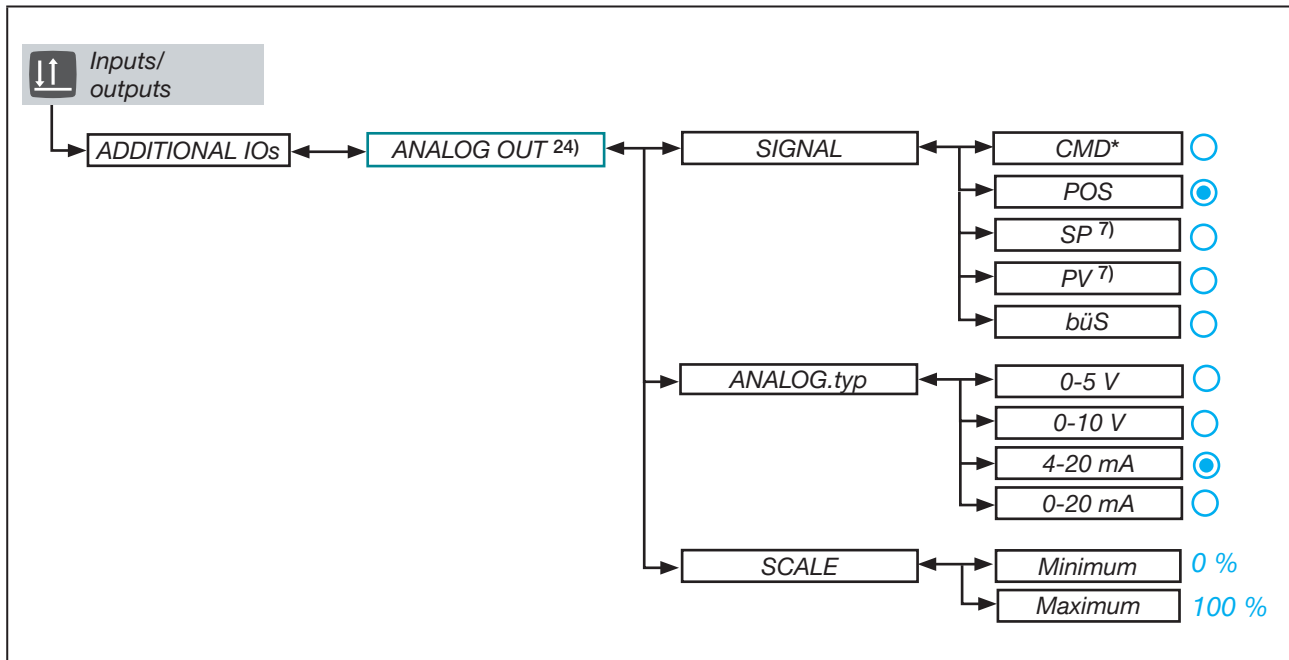

Fig. 76: Operating structure – 2-c, “Inputs/outputs” configuration area

MAN 1000274112 EN Version: H Status: RL (released | freigegeben) printed: 26.01.2023

7) Only available in devices with process control function

24) Only available in devices with analogue output option.

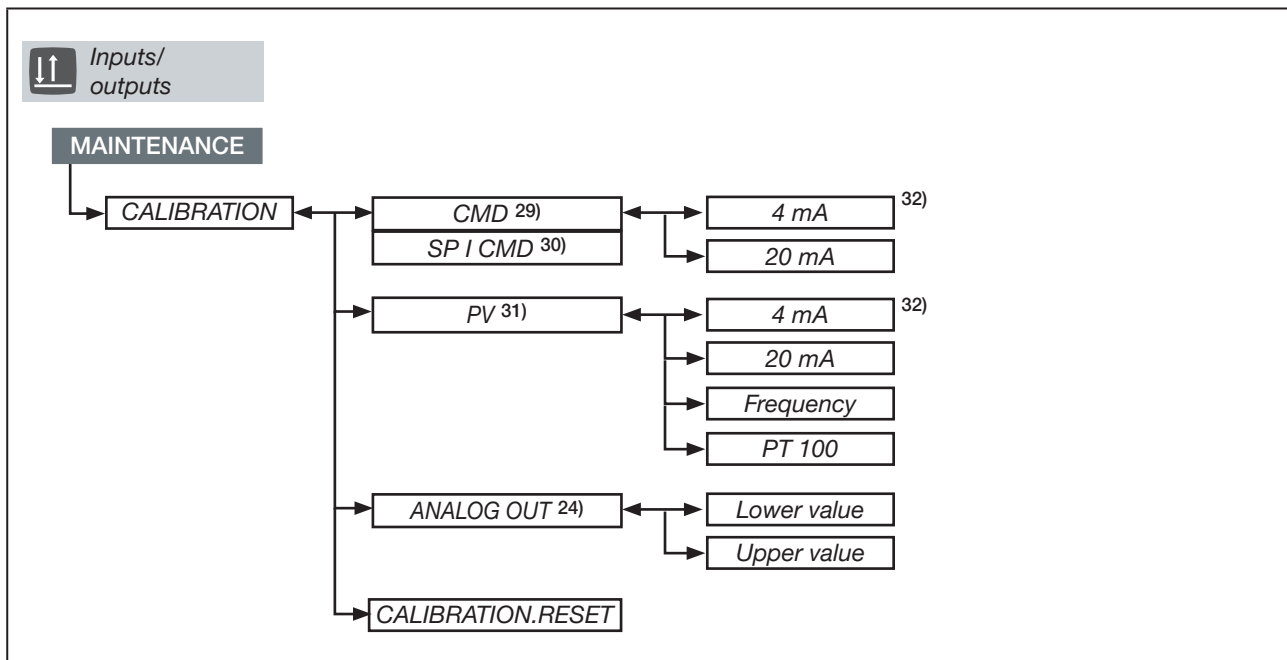
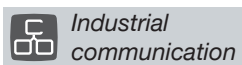

Fig. 77: Operating structure – 2-d, inputs/outputs maintenance



### Industrial communication

The “Industrial Communication” configuration area is only available in devices equipped with a fieldbus gateway.  
The Industrial Communication menu is described in the separate software manual.

**Download at:** [www.burkert.com](http://www.burkert.com) / Type 3360, 3361 / Downloads “Operating instructions” / Software manual Type 3360.

Fig. 78: Operating structure – 3, Industrial communication

24) Only available in devices with analogue output option.

29) Only available in devices with position controller function if selected in menu **CMD** → **CMD.source** → **Analog**.

30) Only available in devices with process control function if selected in menu **SP I CMD** → **CMD.source** or **SP.source** → **Analog**.

31) Only available in devices with process control function if selected in menu **PV** → **PV.source** → **Analog**.

32) The display depends on the set input signal → **Inputs/outputs** → Menu **ANALOG.type** or **TYPE**.

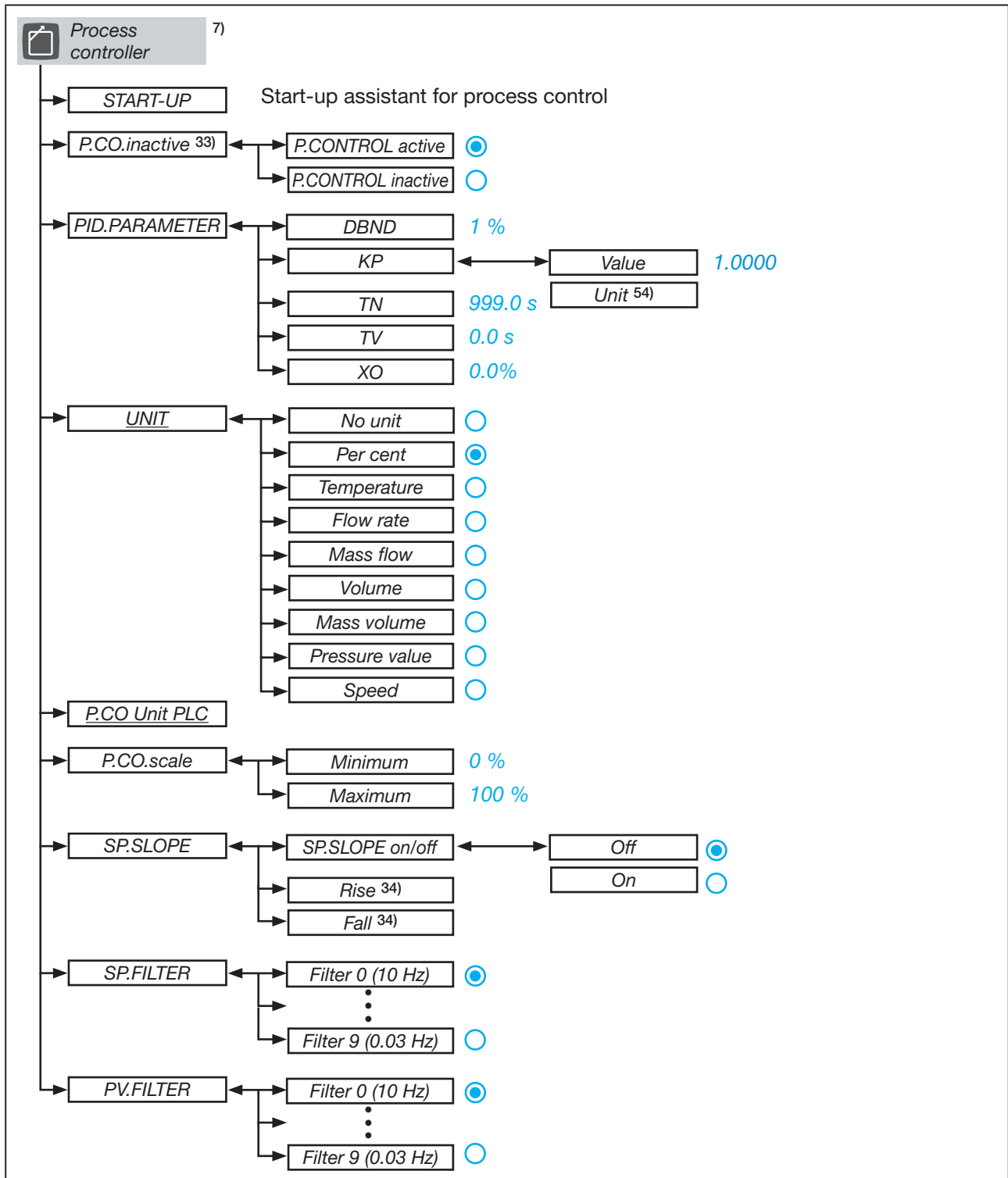

Fig. 79: Operating structure – 3-a, “Process controller” configuration area

7) Only available in devices with process control function.

33) Not available if the setting is made via the digital input, büS/CANopen or fieldbus. Setting: **Inputs/outputs** → **DIGITAL IN** → **X.CO P.CO.source**.

34) Only available if selected in the menu **SP.SLOPE** → **SP.SLOPE on/off** → **On**.

54) Not available if selected in menu **UNIT** → **No unit** or **per cent**.

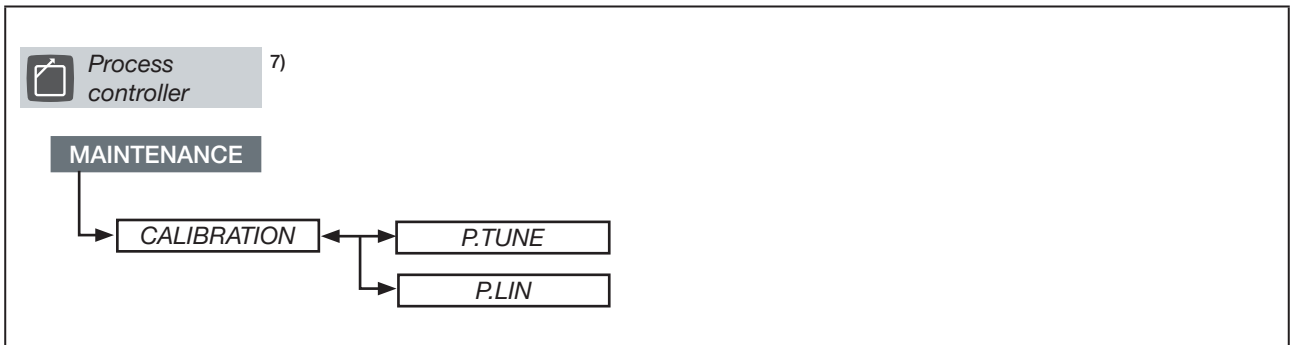

Fig. 80: Operating structure – 3-b, process controller maintenance

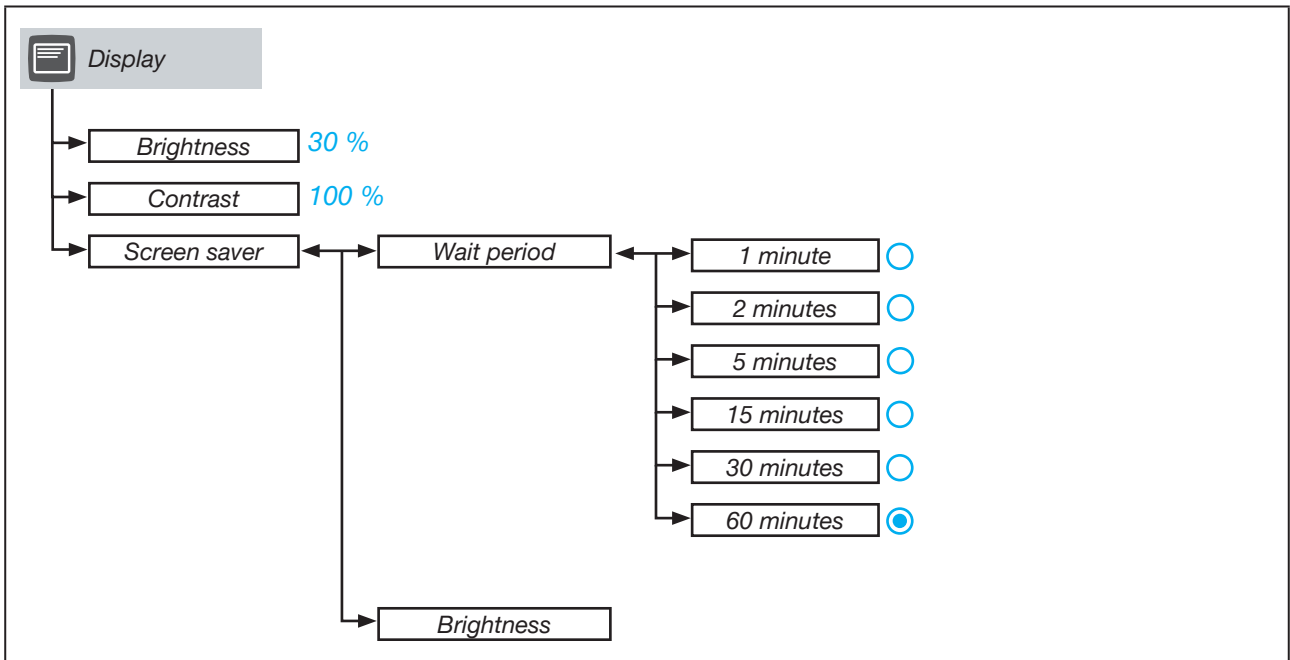

Fig. 81: Operating structure – 4-a, “Display” configuration area

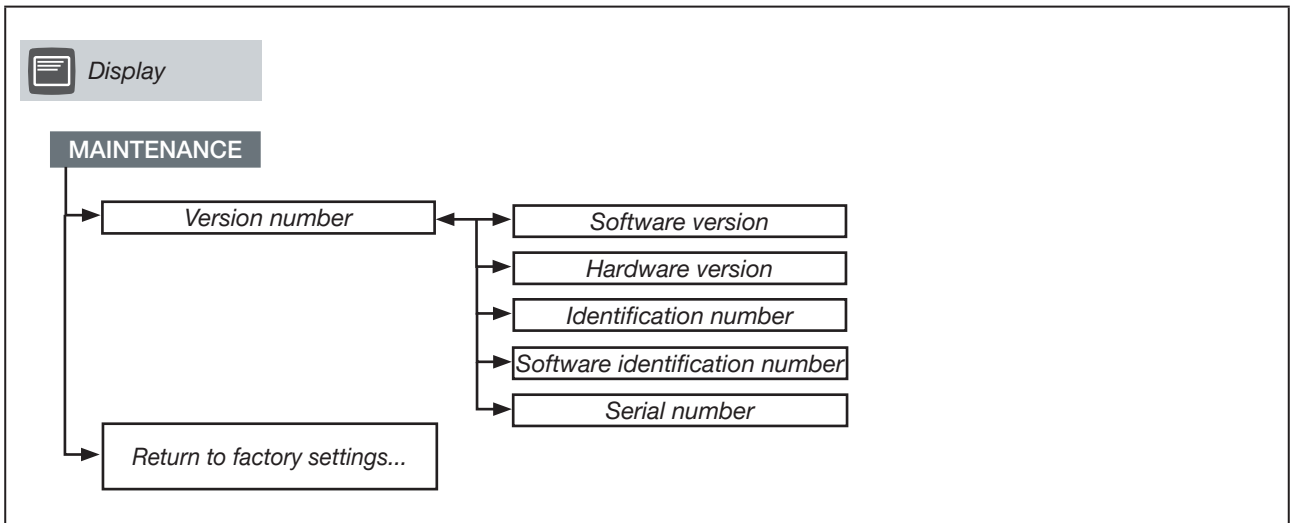

Fig. 82: Operating structure – 4-c, maintenance display



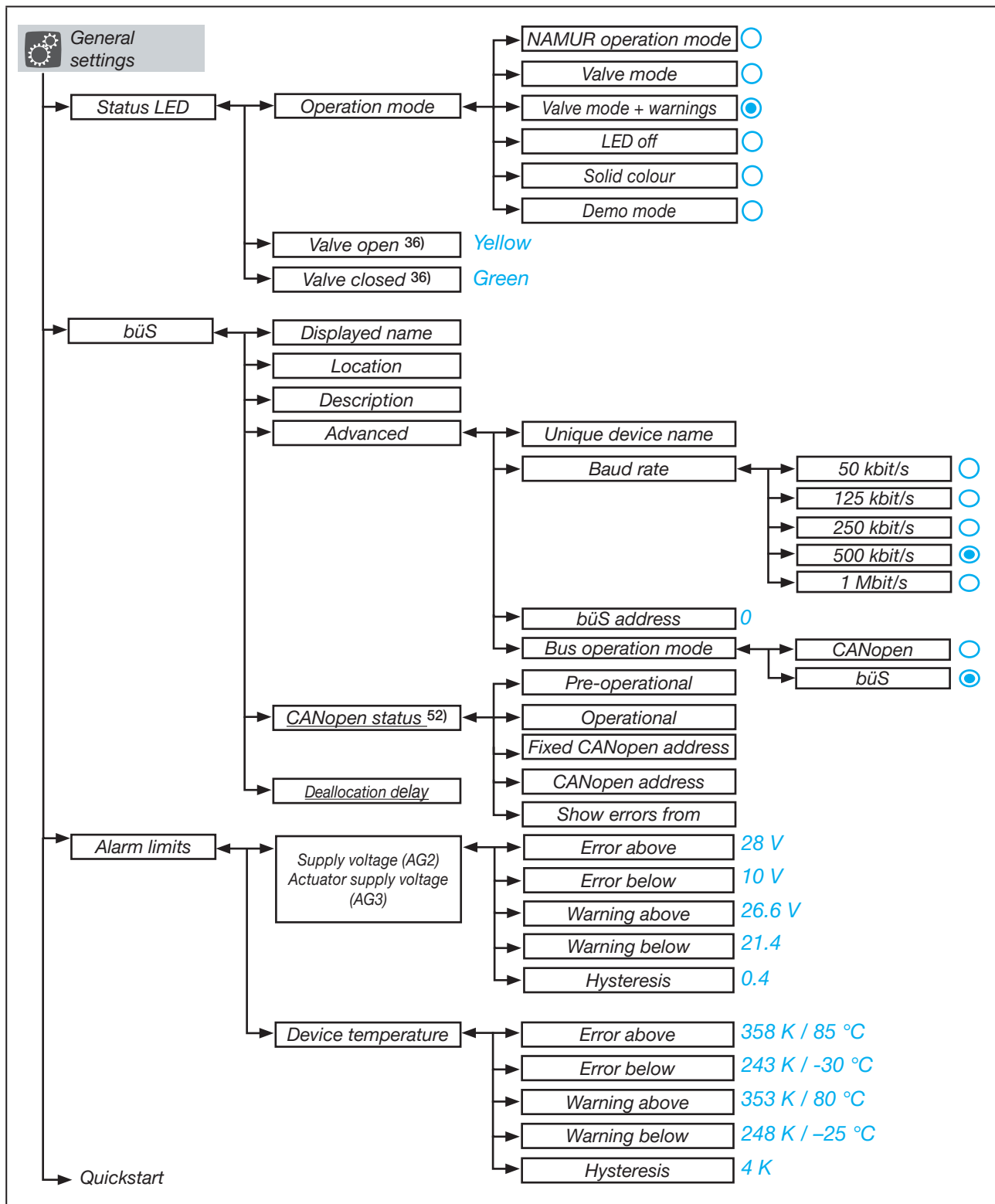

Fig. 83: Operating structure – 5-a, configuration area “General settings”

36) Only available if selected in the menu **Operation mode** → **Valve mode** or **Valve mode+warnings**.

52) Only available if selected in the menu **Bus operation mode** → **CANopen**.

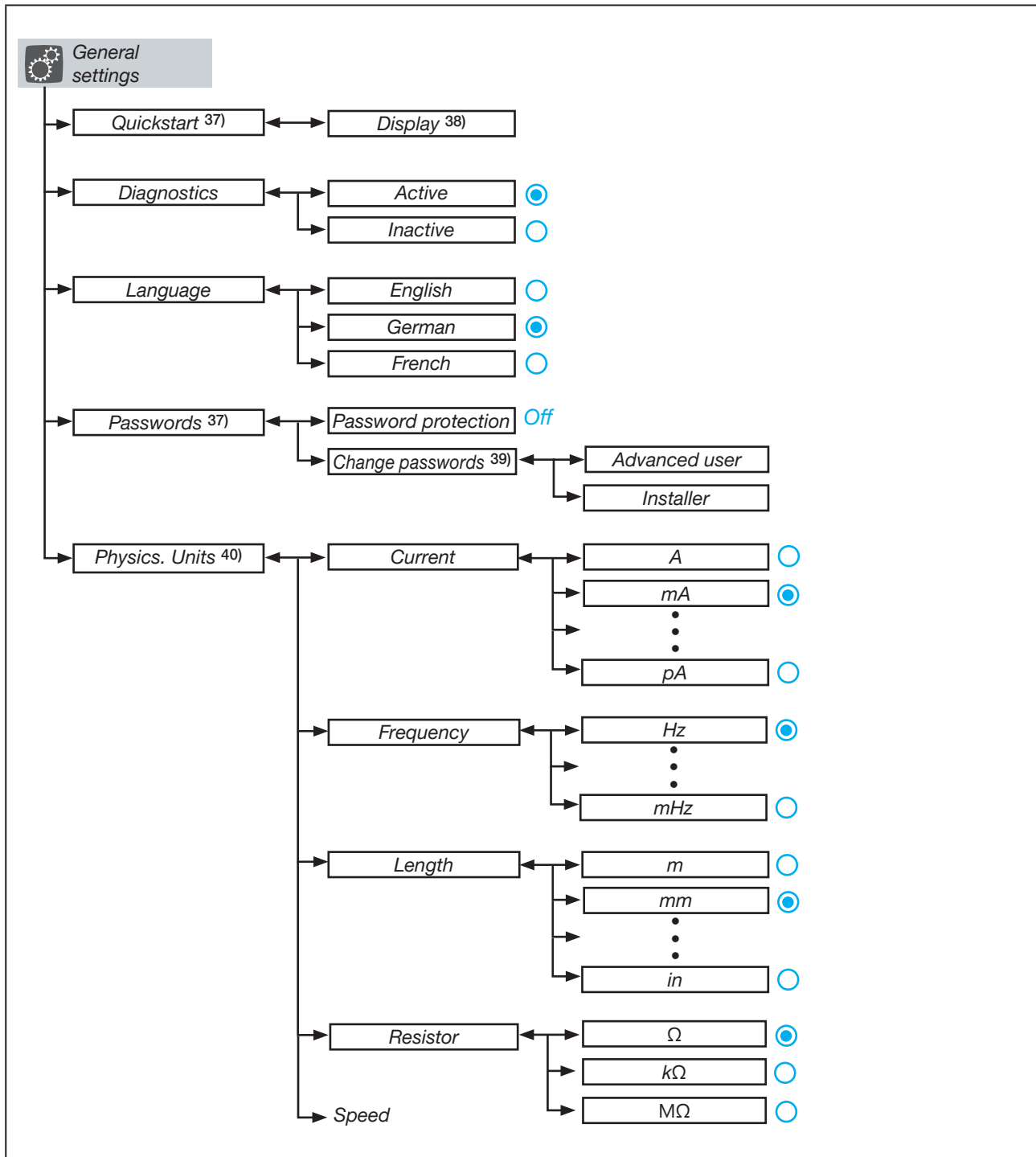

Fig. 84: Operating structure – 5-b, configuration area “General settings”

37) Only available on display.

38) The menu name depends on the selected language.

39) Only available if selected in the menu **Password protection** → **On**.

40) Only available on display.

The setting in the Communicator software is made in the menu bar **View** → **Unit system**.

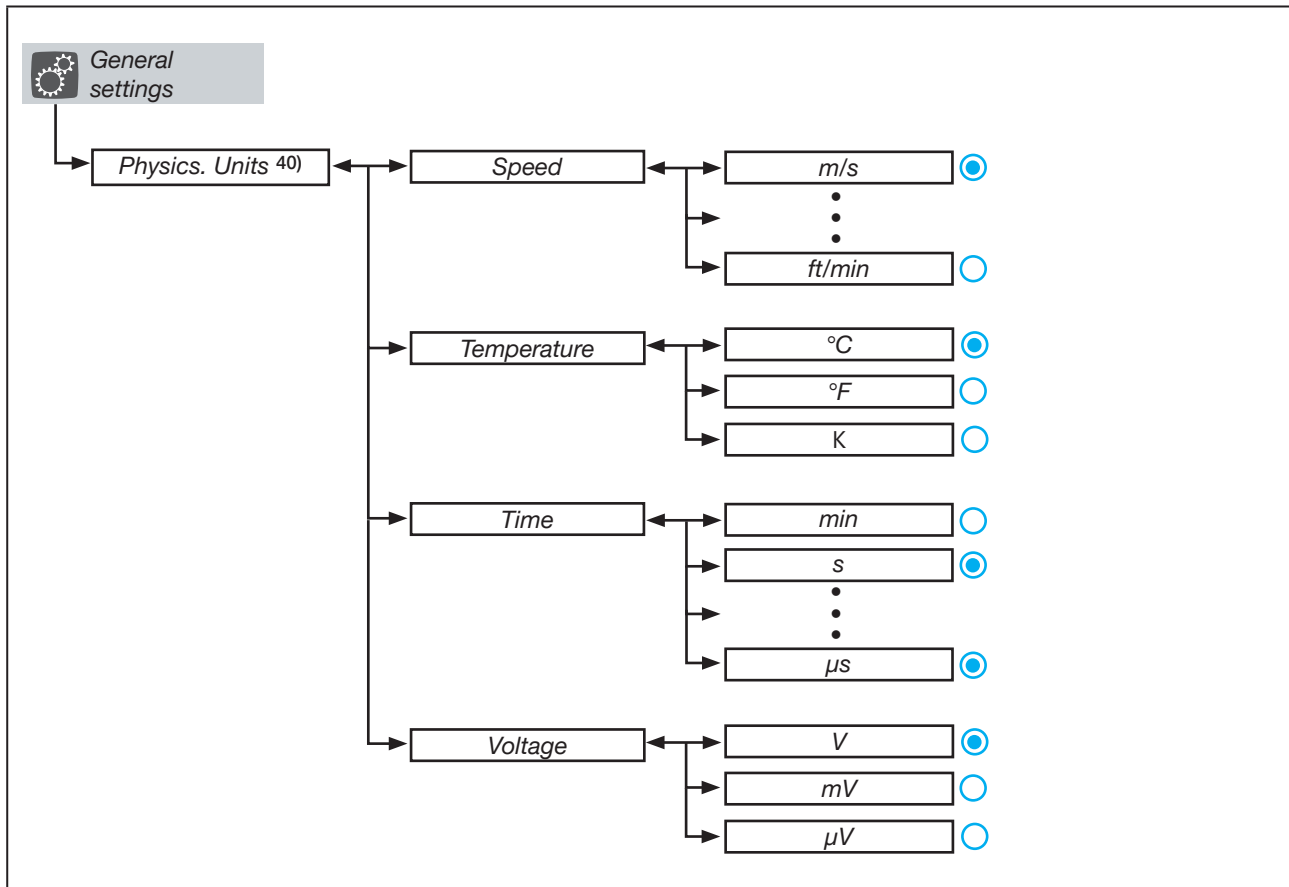
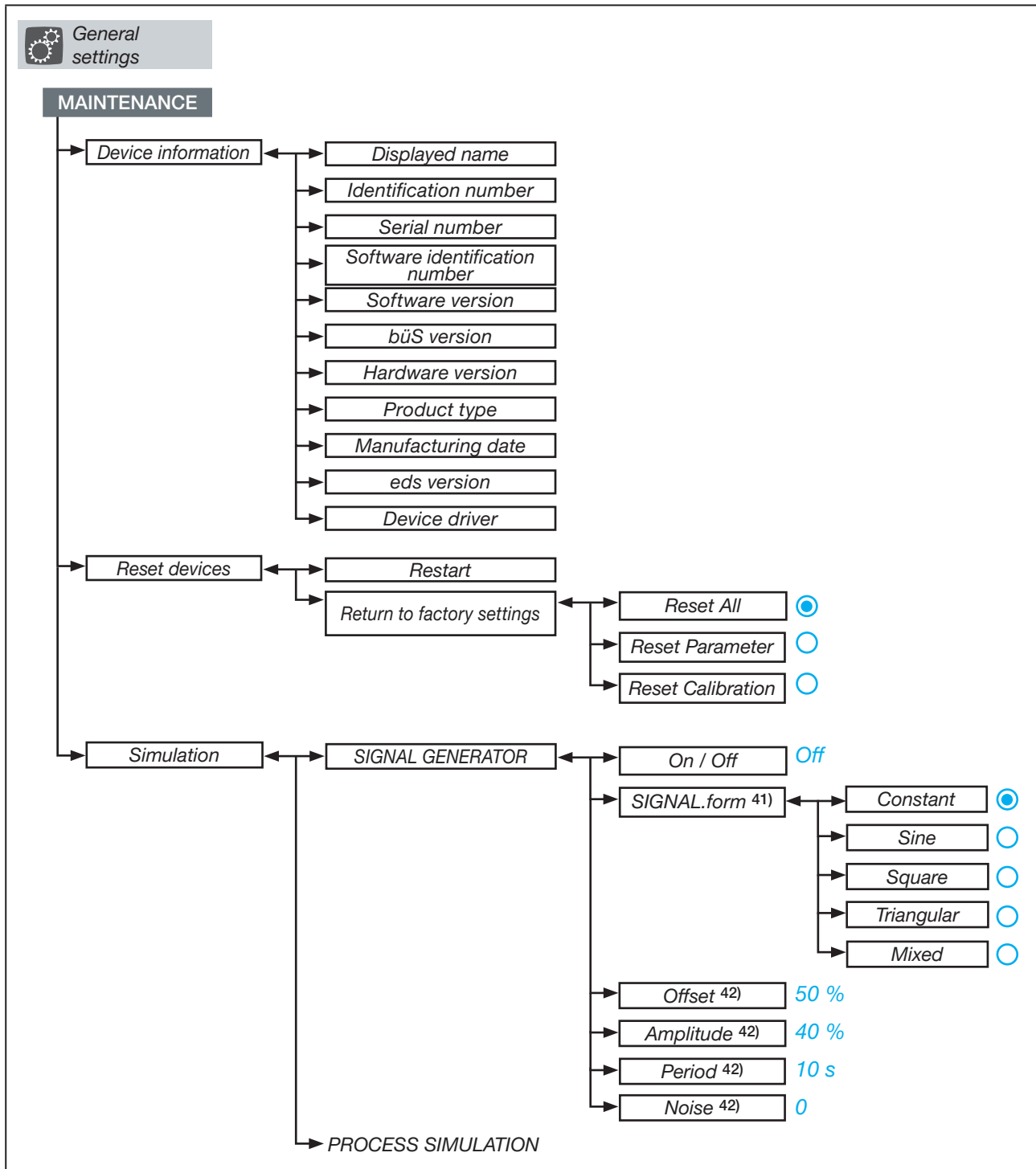

Fig. 85: Operating structure – 5-c, configuration area “General settings”

40) Only available on display.

The setting in the Communicator software is made in the menu bar **View** → **Unit system**.



MAN 1000274112 EN Version: H Status: RL (released | freigegeben) printed: 26.01.2023

Fig. 86: Operating structure – 5-d, general settings maintenance

41) Only available if selected in the menu **SIGNAL GENERATOR** → **on | off** → **On**.

42) The display depends on the selection in the menu **SIGNAL.form**.

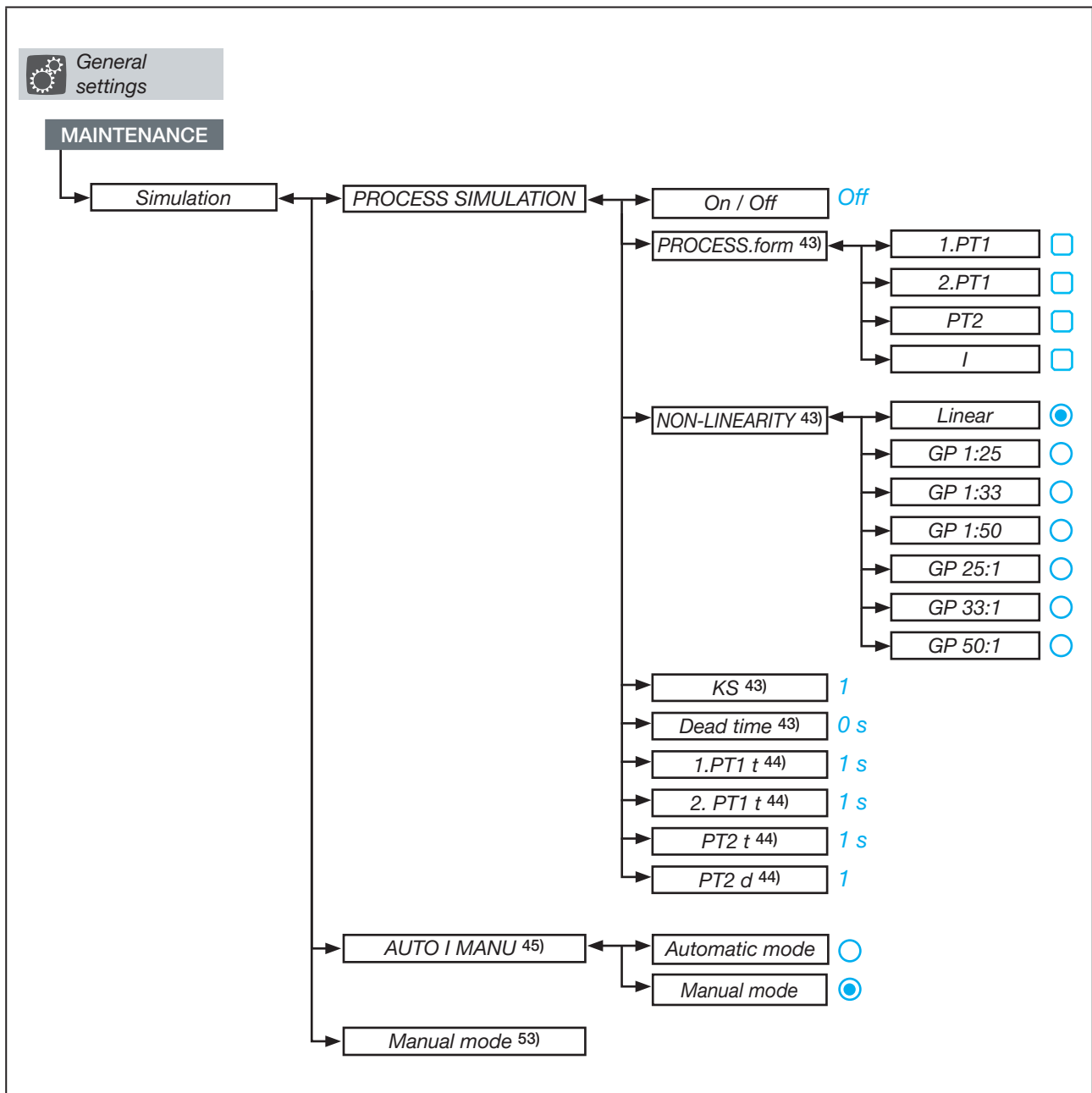

Fig. 87: Operating structure – 5-d, general settings maintenance

43) Only available if selected in the menu **PROCESS SIMULATION** → **on / off** → **On**.

44) Display depends on selection in menu **PROCESS.form**.

45) Only available in devices with display module.

53) Only available in devices with display module and if selected in menu **AUTO I MANU** → **Manual mode**.

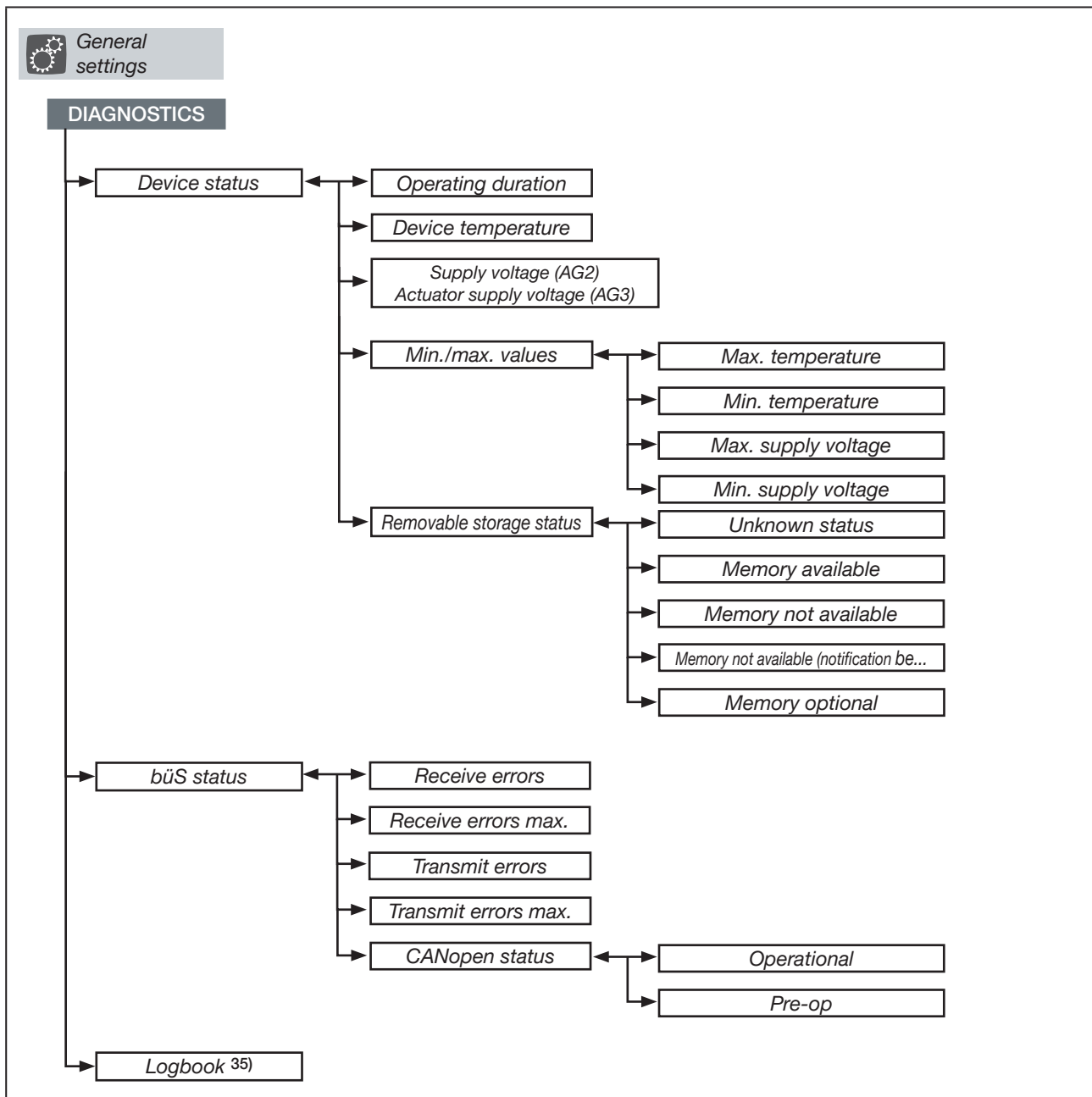

Fig. 88: Operating structure – 5-f, general settings diagnostics

MAN 1000274112 EN Version: H Status: RL (released | freigegeben) printed: 26.01.2023

## 17.2 Context menu for operation on display

The context menu is only available on the display in the operating structure shown.

In the Bürkert Communicator software, the partially identical menus are integrated differently into the operating structure.



A detailed description of the Bürkert Communicator software can be found in the respective operating instructions. Download at: [www.burkert.com / Communicator](http://www.burkert.com / Communicator)

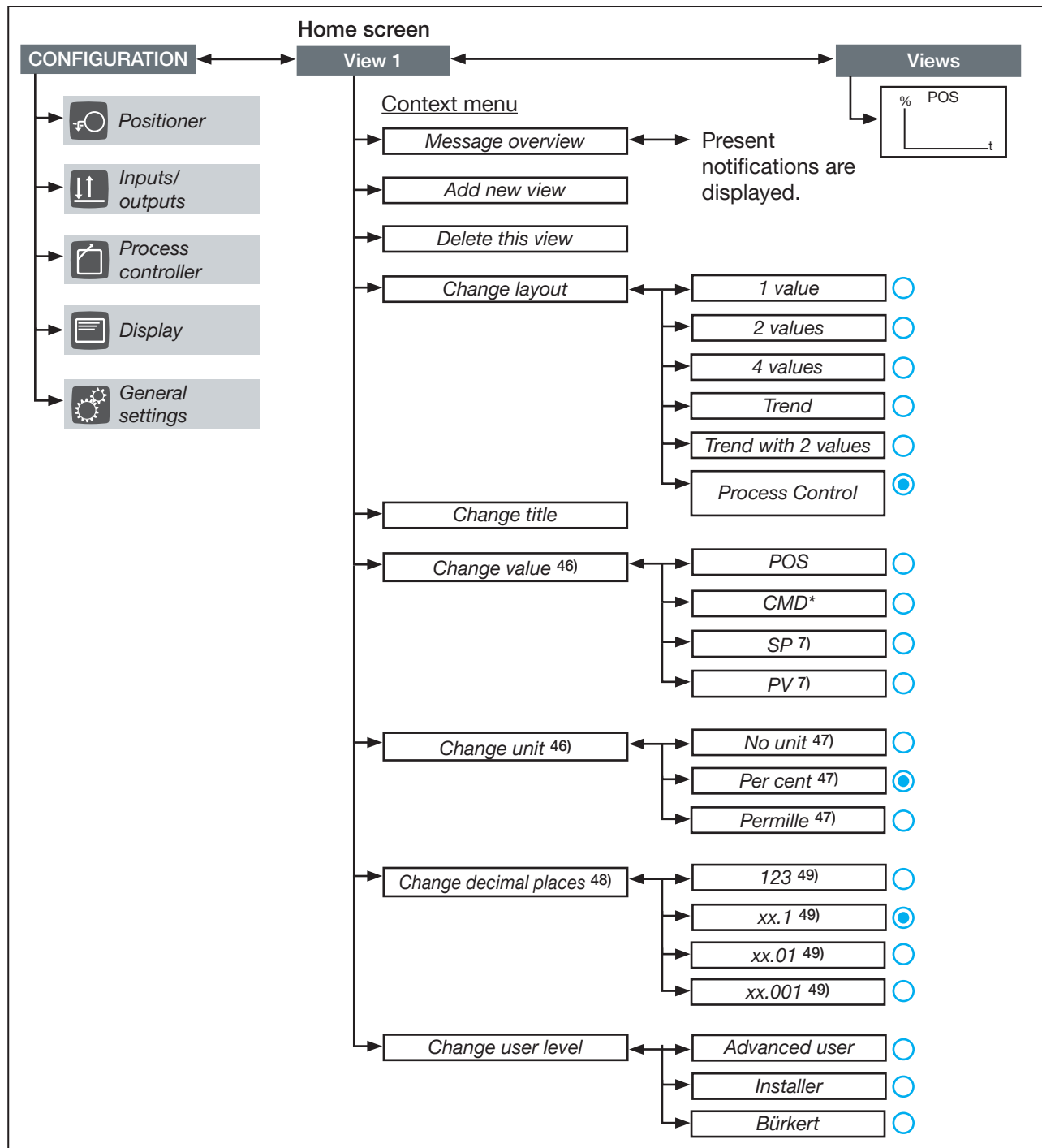

Fig. 89: Operating structure – 6, context menu for views

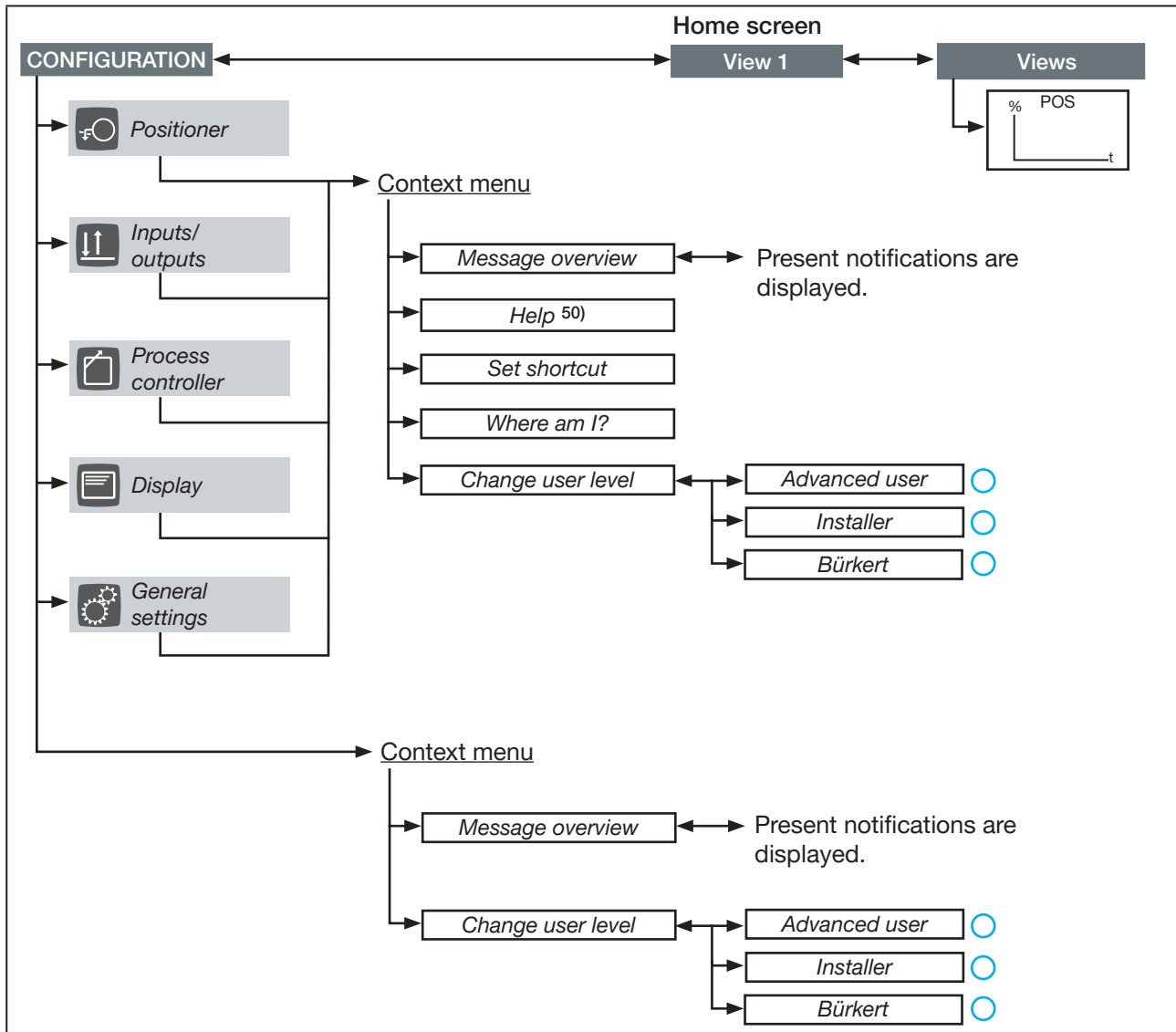

Fig. 90: Operating structure – 7, context menu in configuration area

7) Only available in devices with process control function

46) Not available for layout **Process Control**. With set layout **2 values** or **4 values**, a submenu for assigning the value to be changed is displayed.

47) During process control, the selection depends on the physical unit of the process control (**Process controller** → **UNIT**) and the value selected to be shown on the display (Context menu → **Change value**).

48) Not available for layout **Trend**, **Trend with 2 values** or **Process Control**. With set layout **2 values** or **4 values**, a submenu for assigning the value to be changed is displayed.

49) Not constantly available.

50) Only available in configuration area **Position controller**, **Inputs/outputs** and **Process controller**.



## 18 INDUSTRIAL ETHERNET

To allow connection to an Ethernet network, the electromotive control valve with integrated fieldbus gateway is optionally available.

Supported fieldbus protocols: Ethernet/IP, PROFINET, Modbus TCP.

### 18.1 Fieldbus gateway description

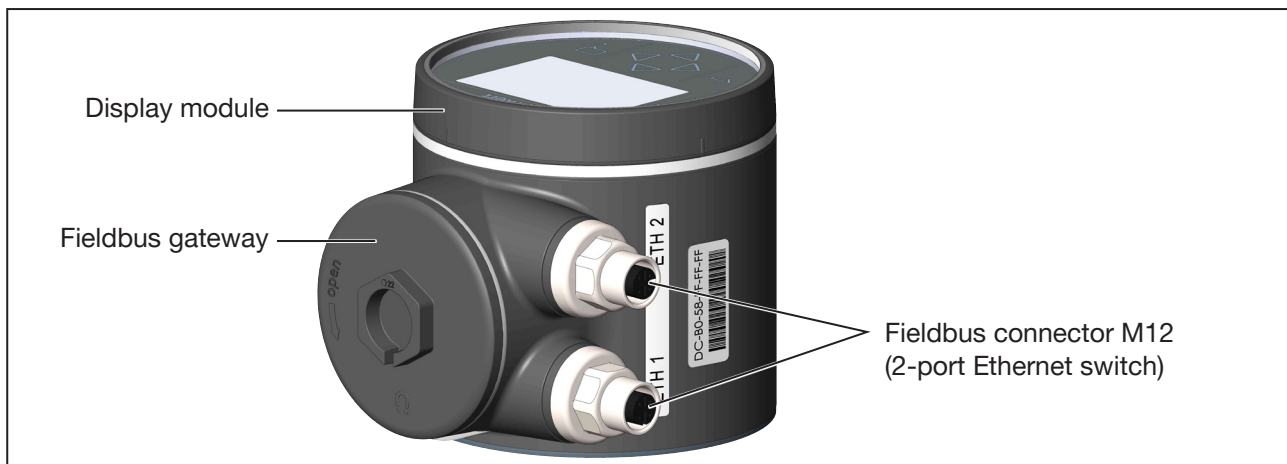

Fig. 91: Fieldbus gateway with display module

#### 18.1.1 LEDs for indicating network connection status

The LEDs for indicating network connection status are located inside the fieldbus gateway. To access it, turn the cover counterclockwise.

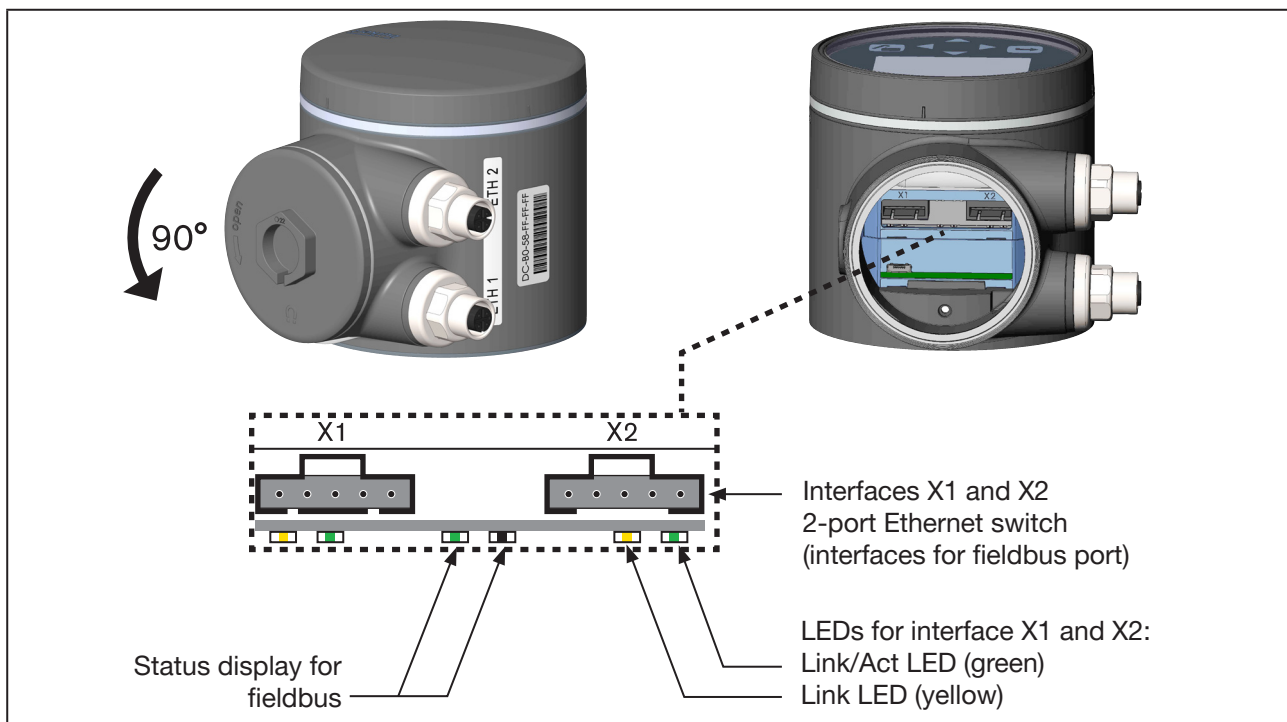

Fig. 92: LEDs for indicating network connection status

LED status		Fault description/cause	Measure
Link/Act LED (green)	Active	Rapid flashing: connection with overriding protocol layer EtherNet/IP has been established. Data are being transmitted.  Slow flashing: there is no connection to the protocol layer. This is normally the case for approx. 20 seconds after restarting.	
	Not active	No connection to the network available.	Check cable.
Link LED (yellow)	Active	Connection to network active.	-
	Not active	No connection to the network available.	Check cable.

Table 47: LED status indicators of interfaces X1 and X2 for EtherNet/IP (fieldbus port)

## 18.2 Technical data Industrial Ethernet

### 18.2.1 PROFINET IO specifications

Topology recognition	LLDP, SNMP V1, MIB2, Physical Device
Minimum cycle time	10 ms
IRT	not supported
MRP media redundancy	MRP client is supported
Other supported functions	DCP, VLAN Priority Tagging, Shared Device
Transmission speed	100 MBit/s
Data transport layer	Ethernet II, IEEE 802.3
PROFINET IO specification	V2.3
(AR) Application Relations	The device can simultaneously process up to 2 IO-ARs, 1 Supervisor AR and 1 Supervisor-DA AR.

### 18.2.2 EtherNet/IP specifications

Pre-defined standard objects	Identity Object (0x01) Message Router Object (0x02) Assembly Object (0x04) Connection Manager (0x06) DLR Object (0x47) QoS Object (0x48) TCP/IP Interface Object (0xF5) Ethernet Link Object (0xF6)
DHCP	supported
BOOTP	supported
Transmission speed	10 and 100 MBit/s
Duplex modes	Half duplex, full duplex, auto-negotiation
MDI modes	MDI, MDI-X, Auto-MDIX
Data transport layer	Ethernet II, IEEE 802.3
Address Conflict Detection (ACD)	supported
DLR (ring topology)	supported
Integrated switch	supported
CIP reset service	Identity Object Reset Service types 0 and 1

### 18.2.3 Modbus TCP specifications

Modbus function codes	1, 2, 3, 4, 6, 15, 16, 23
Operation mode	Message Mode: Server
Transmission speed	10 and 100 MBit/s
Data transport layer	Ethernet II, IEEE 802.3

## 18.3 Projecting via fieldbus

For project planning, you need the suitable start-up file for the respective fieldbus protocol.

Fieldbus	Start-up file
EtherNet/IP	EDS file
PROFINET	GSDML file
Modbus TCP	not required

The start-up files required for the respective project planning software and their description are available on the Internet.



**Download at:**

[www.burkert.com](http://www.burkert.com) / Type 3360, 3361 / Downloads “Software” / Initiation Files

Please refer to the documentation of your project design software for instructions regarding the installation of the start-up files.

### 18.3.1 Setting the Ethernet parameters for EtherNet/IP, PROFINET, Modbus TCP



With Modbus TCP, it is essential to set the Ethernet parameters.



**Setting option:**

Using the Bürkert Communicator software, using the web server or on the display of the device (option).

Settings are created on the PC using the büS service interface and the Bürkert Communicator software. It requires the USB büS interface set available as an accessory.

Display operation: button functions

	Select, activate		Confirm		Back
--	------------------	--	---------	--	------

To set the Ethernet parameters, you must switch to the detailed view “Parameters for Industrial Communication”.

**How to switch to detailed view:**

→ For setting with Bürkert Communicator, select **Industrial Communication** in the navigation area.

→ When using the display for the configuration, switch to **CONFIGURATION** on the home screen and select **Industrial Communication**.



You are now in the “Parameter” detailed view.

 The Ethernet parameters can only be set when the corresponding fieldbus protocol has been selected. **Parameter** → **Protocol settings** → **Protocol** → Select protocol.

#### Setting the Ethernet parameters:

- Select **Protocol settings**.
- Select **Protocol** and set the desired fieldbus protocol.

#### Settings:

- Select **IP settings** and create settings.
- **DNS compatible name** can only be set with PROFINET. Factory default setting: do not discard
- **Fixed IP address** Factory default setting: 192.168.0.100
- **Network mask** Factory default setting: 255.255.255.0
- **Standard gateway** Factory default setting: 192.168.0.1.

 With PROFINET, the factory default setting for the standard gateway is 0.0.0.0.

#### Setting for EtherNet/IP fieldbus protocol:

- Select **IP settings**.
- Select **IP operation mode** and set the desired operation mode. Factory default setting: **Fixed IP address**.
- ✓ You have set the Ethernet parameters to connect the device to the PLC network.

The complete Industrial Communication menu is described in the separate software manual.



**Download at:** [www.burkert.com](http://www.burkert.com) / Type 3360, 3361 / Downloads "Operating instructions" / Software manual Type 3360...

## 18.4 Web server

The configuration of the Ethernet participant, required to connect to the network, can be run with a web server.

### 18.4.1 Connecting to the web server

→ Only for PROFINET: Assign IP addresses and DNS-compatible name with a suitable start-up tool for PROFINET attachments.

→ Set IP address in the PC network card.

IP address: 192.168.0.xxx

For xxx, enter any numerical value other than 100  
(100 is occupied by the IP address of the Ethernet participant by default).

→ Connect the PC with a network cable to the Ethernet participant.

### 18.4.2 Access to the web server

The screenshot shows a web browser interface for the Bürkert web server. At the top left is a 'Menu' button with a hamburger icon. The top right features the Bürkert logo. Below the header, the text 'Bürkert' is on the left and 'S/N: 99' is on the right. The main heading is 'Industrial Communication'. Below this is a table with the following data:

Protocol	Ethernet/IP
Communication status	Wait for establishing communication
MAC address	00:50:C2:C7:E0:01
Static IP address	192.168.0.100
Network mask	255.255.255.0
Default gateway	192.168.0.1
Temporary IP address	192.168.0.100
IP settings	None

Fig. 93: Access to the web server via the default IP

With EtherNet/IP, DHCP or BOOTP can also be set (NOT by default).  
In this process, the IP address is acquired from a DHCP server.

→ Open an internet browser.

→ Enter default IP **192.168.0.100**.

(On EtherNet/IP devices, the IP address is assigned by a DHCP server. If no address is assigned via DHCP within 1 minute, the device uses the default IP 192.168.0.100.)

The software for configuring the Ethernet participant is now available on the PC.



**Configuration of multiple devices:**

On delivery, all devices have the same IP address (192.168.0.100 or 0.0.0.0 for PROFINET). So that the device can be identified for configuration, only 1 unconfigured device may be on the network.

- ▶ Successively connect the devices (Ethernet participants) to the network individually and configure them.

### 18.4.3 Configuring Ethernet participants

Logging onto the system:

→ Enter your user name and password .

Username: **admin**

Password: **admin**

Menu		bürkert	
Bürkert		S/N: 99	
<b>User login</b>			
User name	admin		
User password	admin		X
Login			

Fig. 94: Logging onto the system

Configuration:

- Enter the device name and IP address for the Ethernet participant.  
The device name assigned here is used later during project planning (e.g. under STEP 7).
- Confirm with **Commit changes**.
- Conduct a power reset of the Ethernet participant to incorporate the changed parameters.
- Restart the device with **Restart device**.

Menu		bürkert
Bürkert		S/N: 99
<h2>Network Configuration</h2>		
Protocol	EtherNet/IP	▼
Static IP address	192.168.0.100	
Network mask	255.255.255.0	
Default gateway	192.168.0.1	
IP settings	None	▼
<b>Commit changes</b>		<b>Restart device</b>

Fig. 95: Configuring Ethernet participants



## 19 CANopen



For electrical installation of devices with CANopen network: refer to chapter [“10.2 Electrical connection fieldbus gateway”](#) for description.

### 19.1 Projecting via fieldbus

For project planning, you need an eds file as a start-up file for CANopen.

The eds file and the associated description are available on the Internet.



**Download at:**  
[www.burkert.com](http://www.burkert.com) / Type 3360, 3361 / Downloads “Software” / Initiation Files

Please refer to the documentation of your project design software for instructions regarding the installation of the start-up files.

### 19.2 CANopen network configuration

Instructions for the network configuration based on the CANopen protocol are available on the Internet.



**Download at:**  
[www.burkert.com](http://www.burkert.com) / Type 3360, 3361 / Downloads “Operating instructions” / “Software instructions | CANopen network configuration”

## 20 büS

Definition: the term “büS” (Bürkert System buS) refers to the communication buS developed by Bürkert, based on the CANopen protocol.



For electrical installation of devices with büS network:  
refer to chapter [“10.2 Electrical connection fieldbus gateway”](#) for a description.

### 20.1 Cabling of büS networks



You can find additional information about cabling for büS networks under the search term “cabling guide” at our webpage: [country.burkert.com](http://country.burkert.com)

### 20.2 Configuration of büS networks

Additional information about the configuration of büS networks can be found on the Internet.



Download at:  
[www.burkert.com](http://www.burkert.com) / Type 8922 / Downloads / User Manuals / [Software instructions Typ8922, MExx | Software of f\(x\) configuration](#)

## 21 MAINTENANCE

The maintenance work is described in the separate service instructions. These instructions can be found on our homepage at: <https://country.burkert.com/> → Type 3360, 3361.

### 21.1 Safety instructions



#### **DANGER!**

Risk of injury due to high pressure in the system or device.

- ▶ Switch off the pressure before working on the system or device. Vent or empty the lines.

Risk of injury due to electric shock.

- ▶ Switch off the power supply before working on the device or system. Secure against reactivation.
- ▶ Observe the applicable accident prevention and safety regulations for electrical devices!



#### **WARNING!**

Risk of injury due to improper maintenance work.

- ▶ Maintenance may be carried out only by trained specialist technicians and with the appropriate tools.
- ▶ Secure the system against unintentional activation.
- ▶ Following maintenance, ensure a controlled restart.

### 21.2 Actuator

When used in accordance with these operating instructions, the electromotive actuator is maintenance-free.

### 21.3 Wearing parts of the valve

Parts which are subject to natural wear are:

- Seals
- Control cone

→ If there is a leak, replace the respective wearing part with a corresponding spare part. (For spare part sets and assembly tools see chapter “[24 Accessories, Wearing parts](#)”).

Replacement of the wearing parts is described in the separate service instructions.

These instructions can be found on our homepage at: [country.burkert.com](https://country.burkert.com/) → Type 3360, 3361.

## 21.4 Visual inspection

According to the usage conditions, perform regular visual inspections:

- Check medium ports for tightness.
- Check relief bore on the pipe for leaks.

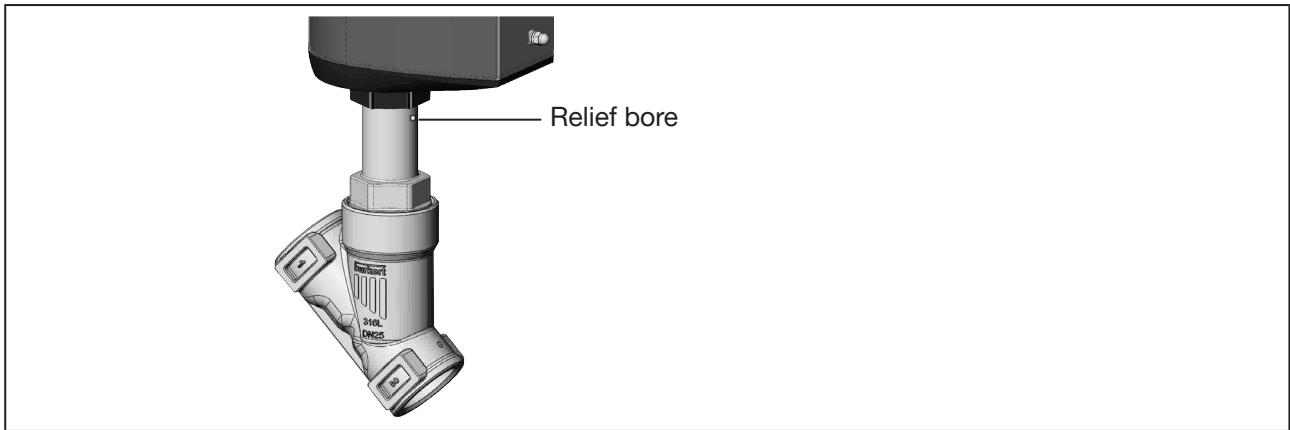

Fig. 96: Relief bore

## 21.5 Maintenance notifications

Maintenance notifications are displayed in the following LED operation modes:

- Valve mode + warnings (factory pre-set).  
The LED light ring alternately flashes blue and the colour indicating the valve position.
- NAMUR operation mode.  
The LED light ring glows blue.



If the LED operation mode is set to “valve mode”, maintenance notifications are not displayed.

Notification	Device behaviour	Measure
The capacity of the energy storage is strongly decreased. The energy storage must be replaced soon.	Maintenance notification.	The SAFEPOS energy-pack must be promptly replaced before the end of its service life.

Table 48: Maintenance notifications

## 22 TROUBLESHOOTING AND MESSAGES

### 22.1 Error notifications

Device error notifications are displayed as follows:

- Valve mode  
The LED light ring alternately flashes red and the colour indicating the valve position.
- Valve mode + warnings (factory pre-set).  
The LED light ring alternately flashes red and the colour indicating the valve position.
- NAMUR operation mode.  
The LED light ring glows red.

Notification	Description	Device behaviour	Measure
Motor temperature is too high. Motor is moving to the safety position.	Too much friction in the actuator train for operation.	Error notification. Actuator is moving to the safety position.	Contact Bürkert service.
Motor temperature is too high. Motor is idling to prevent thermal damage.	Too much friction in the actuator train for operation.	Error notification. Motor switches off. Actuator remains in place. MANUAL operating state not possible.	Contact Bürkert service.
Excess temperature detected.	Device temperature too high for operation.	Error notification. Actuator is moving to the safety position. MANUAL operating state possible.	Reduce ambient temperature. Contact Bürkert Service if problem persists.
Low temperature detected.	Device temperature too low for operation.	Error notification. Actuator is moving to the safety position. MANUAL operating state possible.	Increase ambient temperature.
Overvoltage detected. (AG2) Overvoltage actuator supply detected (AG3)	Supply voltage too high for device operation.	Error notification. Actuator is moving to the safety position. MANUAL operating state possible.	Check supply voltage.
Undervoltage detected. (AG2) Undervoltage actuator supply detected (AG3)	Supply voltage failure, or supply voltage too low for device operation.	Error notification. Actuator is moving to the safety position. MANUAL operating state not possible.	Check supply voltage. Contact Bürkert Service if problem persists.

Notification	Description	Device behaviour	Measure
Motor current too high.	Increased friction in the actuator train or incorrect detection of the end positions.	Error notification. Motor switches off. Actuator remains in place. MANUAL operating state not possible.	Carry out the X.TUNE function. Contact Bürkert Service if problem persists.
Motor peak current too high.	Increased friction in the actuator train or incorrect detection of the end positions.		
Internal error: reversion sensor signal failure.	Signal failure of the position sensor.	Error notification. Actuator is moving to safety position. MANUAL operating state not possible.	Contact Bürkert service.
Internal error: ...	Internal error in the device.	Error notification. Actuator is moving to the safety position.	Contact Bürkert service.
CMD/SP cable break.	Cable break in the set-point value signal.	If device is configured accordingly: error notification. Actuator is moving to the safety position.	Check signal line of set-point value.
PV cable break.	Cable break of the process actual value signal.	If device is configured accordingly: error notification. Actuator is moving to the safety position.	Check signal line of process actual value.
Persistent memory unusable: defective or not available.	Reading or writing error of internal data storage EEPROM.	Error notification. Actuator is moving to the safety position	Restart the device. Contact Bürkert Service if problem persists.
BüS event: producer(s) not found.	Assigned external büS/CANopen producer cannot be found.	Error notification. Actuator is moving to the safety position.	Check signal to büS/CANopen partner.
BüS event: bus connection lost/not available.	büS/CANopen network cannot be found.	Error notification. Actuator is moving to the safety position.	Check büS/CANopen network.
BüS event: producer is not operational.	Producer not operational in this state.	Error notification. Actuator is moving to the safety position.	Check büS/CANopen producer.
BüS event: a device is using the same address.	Another büS/CANopen participant is using the same address.	Error notification. Actuator is moving to the safety position.	Assign a unique address to the device and büS/CANopen participant.
No correct connection to the process control system.	No connection to the process control system.	Error notification. Actuator is moving to the safety position.	Check connection to the process control system.
Energy storage must be replaced.	Storage capacity of the energy storage is too low. Assumption of the safety position cannot be guaranteed.	Error notification. Actuator is moving to the safety position.	Replace energy storage SAFEPOS energy-pack.

Notification	Description	Device behaviour	Measure
No energy storage available.	Energy storage SAFEPOS energy-pack not detected.	Error notification. Actuator is moving to the safety position.	Check whether the SAFEPOS energy-pack is correctly installed.

Table 49: Error notifications

## 22.2 Notifications on device status “Out of specification”

Notifications on device status “Out of specification” are displayed in the following LED operation modes:

- Valve mode + warnings (factory pre-set).  
The LED light ring alternately flashes yellow and the colour indicating the valve position.
- NAMUR operation mode.  
The LED light ring glows yellow.



In LED operation mode “valve mode”, notifications on the device status “Out of specification” are not displayed.

Notification	Description	Device behaviour	Measure
Motor temperature is high.	Increased friction in the actuator train.	Notification “Out of specification”	Contact Bürkert Service if problem persists.
Temperature warning limit exceeded.	Ambient temperature too high or increased friction in actuator train.	Notification “Out of specification”	Reduce ambient temperature. Contact Bürkert Service if problem persists.
Temperature warning limit undershot.	Ambient temperature is too low.	Notification “Out of specification”	Increase ambient temperature
Voltage warning limit exceeded. (AG2) Voltage of actuator supply is above the warning limit (AG3)	Supply voltage is too high.	Notification “Out of specification”	Check supply voltage.
Voltage warning limit undershot. (AG2) Voltage of actuator supply is below the warning limit (AG3)	Supply voltage is too low.		
CMD/SP cable break.	Cable break in the set-point value signal.	If device is configured accordingly: message on “Outside of specification” status. Actuator is moving to the safety position.	Check signal line of set-point value.
PV cable break	Cable break of the process actual value signal.	If device is configured accordingly: message on “Outside of specification” status. Actuator is moving to the safety position.	Check signal line of process actual value.

Table 50: Notifications on device status “Out of specification”

## 22.3 Notifications on device status “Function check”

Notifications on device status “Function check” are displayed in the following LED operation modes:

- Valve mode + warnings (factory pre-set).  
The LED light ring alternately flashes orange and the colour indicating the valve position.
- NAMUR operation mode.  
The LED light ring glows orange.



In LED operation mode “valve mode”, notifications on the device status “Function check” are not displayed.

Notification	Description	Device behaviour	Measure
MANUAL operating state active.	Device is in the MANUAL operating state.	Notification “Function check”.	Switch to AUTOMATIC operating state.
Process simulation active	Device is in simulation mode: process values are simulated.	Notification “Function check”.	Switch off process simulation.
Signal generator active	Devices is in simulation mode: input signals are simulated.	Notification “Function check”.	Switch off signal generator.
X.TUNE active	X.TUNE function is run (adaption of position control).	Notification “Function check”.	Wait until the X.TUNE function is exited.
P.TUNE active	P.TUNE function is run (adaption of process control).	Notification “Function check”.	Wait until the P.TUNE function is exited.
P.LIN active	P.LIN function is run (linearization of process characteristic).	Notification “Function check”.	Wait until the P.LIN function is exited.
External CMD not assigned.	“bÜS” is set as the source of the input signal.  Missing assignment of the external bÜS/ CANopen partner.	Notification “Function check”.	Assign an external bÜS/ CANopen fieldbus consumer or set a different source.  Setting the input signal: in the “inputs/outputs” configuration area.
External SP not assigned.			
External PV not assigned.			
External isPCOextern not assigned.			
External ExtError not assigned.			

Table 51: Notifications on device status “Function check”

## 23 CLEANING

### NOTE!

Do not use alkaline cleaning agents to clean the surfaces of the device.

The detergent resistance and material compatibility of the exterior components with common Ecolab products is tested and certified according to Ecolab test method: R&D/P3-E No. 40 - 1.



## 24 ACCESSORIES, WEARING PARTS



### CAUTION!

Risk of injury and/or damage due to incorrect parts.

Incorrect accessories and unsuitable wearing parts may cause injuries and damage the device and the area around it.

► Use only original accessories and original wearing parts from Bürkert.



You can find wear parts and assembly tools under the following link (device identification number required):

[Wear parts and assembly tools](#)



You can find additional information about cabling for bÜS networks under the search term “cabling guide” at our webpage: [country.burkert.com](http://country.burkert.com)

Accessories	Order number
Connection cable with M12 socket, 4-pin, (length 5 m) for operating voltage AG2 (without communication) for X3	00918038
Connection cable with M12 socket, 8-pin, (length 2 m) for input and output signals for X1	00919061
Connection cable with M12 plug, 5-pin, (length 2 m) for input signals process actual value (only for variant with process controller) for X2	00559177
Connection cable with M12 socket, 5-pin, L-coded (length 5 m) for operating voltage AG3 (without communication) for X4	20010840
USB bÜS interface set:	
USB bÜS interface set 1 (includes power supply unit, bÜS stick, terminating resistor, Y-distributor, 0.7 m cable with M12 plug)	00772426
USB bÜS interface set 2 (includes bÜS stick, terminating resistor, Y-distributor, 0.7 m cable with M12 plug)	00772551
bÜS adapter for bÜS service interface (M12 to micro-USB bÜS service interface)	00773254
bÜS cable extensions from M12 plug to M12 socket	
Connection line, length 1 m	00772404
Connection line, length 3 m	00772405
Connection line, length 5 m	00772406
Connection line, length 10 m	00772407
Bürkert Communicator Type 8920	Info at <a href="http://country.burkert.com">country.burkert.com</a>
SIM card	00291773
Holding device for port connection DN15–DN20	00693770
Holding device for port connection DN25–DN50	00693771

Table 52: Accessories

## 24.1 Communication software

The PC software Bürkert Communicator is designed for communication with Bürkert devices.



A detailed description of the installation and operation of the software can be found in the associated operating instructions.

Download the software from: [country.burkert.com](http://country.burkert.com)

### 24.1.1 büS service interface

The device is equipped with the büS service interface for communicating with the PC. Communication takes place via a USB interface on the PC and the USB büS interface, which is available as an accessory (see “[Table 52: Accessories](#)”).

## 25 DISASSEMBLY

### 25.1 Safety instructions



#### **DANGER!**

Risk of injury due to high pressure and escaping medium.

If the device is pressurised while being disassembled, there is a risk of injury due to sudden depressurisation and medium discharge.

- ▶ Turn off the pressure before dismantling the device. Vent or empty the lines.



#### **CAUTION!**

Risk of injury due to heavy device.

During transportation or installation work, the device may fall down and cause injuries.

- ▶ Transport, install and remove heavy device with the aid of a second person only.
- ▶ Use suitable tools.

#### **NOTE!**

Installing in the AUTOMATIC operating state will damage the device.

Devices that are installed while they are in the AUTOMATIC operating state may be irreparably damaged.

- ▶ If devices are to be re-used, set the MANUAL operating state before they are removed.

- If the device is to be re-used, set the MANUAL operating state.
- Disconnect the electrical connection.
- Dismantle the device.

## 26 PACKAGING AND TRANSPORT

### NOTE!

#### Transport damage!

Inadequately protected devices may be damaged during transport.

- Protect the device against moisture and dirt in shock-resistant packaging during transportation.
- Avoid storage above or below the permitted storage temperature.



### CAUTION!

Risk of injury due to heavy device.

During transportation or installation work, the device may fall down and cause injuries.

- ▶ Transport, install and remove heavy device with the aid of a second person only.
- ▶ Use suitable tools.

## 27 STORAGE

### NOTE!

Incorrect storage may damage the device.

- Store the device in a dry and dust-free location.
- Storage temperature: -40 – +70 °C.

## 28 DISPOSAL

Environmentally friendly disposal



- ▶ Follow national regulations regarding disposal and the environment.
- ▶ Collect electrical and electronic devices separately and dispose of them as special waste.

Information at [country.burkert.com](https://country.burkert.com)



