

Type 8692, 8693 REV.2

Positioner / Process Controller



Operating Instructions

We reserve the right to make technical changes without notice.

© Bürkert Werke GmbH & Co. KG, 2017 - 2023

Operating Instructions 2308/10_EU-EN_00810576 / Original DE

CONTENTS

1	OPERATING INSTRUCTIONS	10
1.1	Symbols.....	10
1.2	Definitions of terms.....	10
2	AUTHORIZED USE	11
3	BASIC SAFETY INSTRUCTIONS	12
4	GENERAL INFORMATION.....	13
4.1	Contact address.....	13
4.2	Warranty	13
4.3	Master code	13
4.4	Information on the internet	13
5	PRODUCT DESCRIPTION.....	14
5.1	General description.....	14
5.2	Properties	14
5.3	Combinations with valve types and mounting variants	15
5.3.1	Overview of mounting possibilities / features of valve types.....	16
5.4	Variants.....	17
5.4.1	Type 8692, position controller	17
5.4.2	Type 8693, process controller	17
6	STRUCTURE AND FUNCTION.....	18
6.1	Representation.....	18
6.2	Function diagram	19
6.2.1	Diagram illustrating single-acting actuator	19
7	THE POSITION CONTROLLER TYPE 8692	20
7.1	Schematic representation of the position control	21
7.2	The position controller software.....	22
8	PROCESS CONTROLLER TYPE 8693.....	24
8.1	Schematic representation of process control	25
8.2	The position controller software.....	26

MAN 1000327408 EN Version: N Status: RL (released | freigegeben) printed: 01.09.2023

9	INTERFACES	28
10	TECHNICAL DATA	29
	10.1 Standards and directives.....	29
	10.2 Approvals	29
	10.3 Operating conditions	29
	10.4 Type label	30
	10.4.1 UL additional label.....	30
	10.5 Mechanical data.....	30
	10.6 Pneumatic data	30
	10.7 Electrical data	31
	10.8 Safety end positions after failure of the electrical or pneumatic auxiliary power.....	32
11	INSTALLATION.....	33
	11.1 Installation of devices for the Ex area.....	33
	11.2 Type 2103, 2300 and 2301	33
	11.2.1 Install switch spindle	34
	11.2.2 Install form seal.....	35
	11.2.3 Install Type 8692/8693.....	36
	11.3 Installation on process valves, series 26xx and 27xx.....	38
	11.3.1 Install switch spindle	38
	11.3.2 Install Type 8692/8693.....	39
	11.4 Installation on rotary actuators from third party manufacturers.....	41
	11.5 Rotating the actuator module.....	42
	11.6 Rotating the Types 8692/8693 for process valves belonging to series 26xx and 27xx.....	44
	11.7 Pneumatic connection of the Type 8692, 8693	45
	11.8 Model with high air flow rate	46
	11.8.1 Manual activation of the actuator via pilot valves.....	46
12	ELECTRICAL INSTALLATION WITHOUT FIELDBUS COMMUNICATION.....	48
	12.1 Electrical installation with circular plug-in connector	48
	12.1.1 X1 - M12 circular connector, 8-pin	49
	12.1.2 X6 - M12 circular connector, 4-pin, operating voltage	50

12.1.3	X5 - M8 circular connector, 4-pin, input signals process actual value (for Type 8693 only)	51
12.1.4	Switch position (only type 8693).....	52
12.2	Electrical installation with cable gland.....	53
12.2.1	Terminal assignment: Input signals from the control center (e.g. PLC)	54
12.2.2	Terminal assignment: Output signals to the control center (e.g. PLC) - (required for analog output and/or digital output option only)	54
12.2.3	Terminal assignment: Process actual value input (for Type 8693 only)	55
12.2.4	Terminal assignment: operating voltage	56
12.2.5	Switch position (only Type 8693).....	56
13	OPERATION.....	57
13.1	Description of the operating and display elements.....	58
13.1.1	Description of the symbols which are displayed on the process level.....	60
13.2	LED for indicating device status	61
13.3	Function of the keys.....	62
13.3.1	Entering and changing numerical values.....	63
13.4	Adjusting the display	64
13.4.1	Possible displays of the process level.....	64
13.5	Switching between the operating levels	66
13.6	Date and time	67
13.6.1	Setting date and time	68
13.7	Operating states.....	69
13.7.1	Changing the operating state	69
13.8	Activating and deactivating auxiliary functions.....	70
13.8.1	Activating auxiliary functions	70
13.8.2	Deactivating auxiliary functions.....	71
13.9	Manually opening and closing the valve.....	72
14	START-UP	73
14.1	Basic setting of the device	74
14.2	INPUT - Setting the input signal.....	74
14.3	X.TUNE – Automatic adjustment of the position controller	75
14.3.1	X.TUNE.CONFIG – Manual configuration of X.TUNE	76
14.4	Activation of the process controller	77

15	BASIC SETTING OF THE PROCESS CONTROLLER.....	78
15.1	<i>P.CONTROL</i> – Setting up and parameterization of the process controller	78
15.2	<i>SETUP</i> – Setting up the process controller	79
15.2.1	<i>PV-INPUT</i> – Specifying signal type for the process actual value.....	79
15.2.2	<i>PV-SCALE</i>– Scaling of the process actual value	79
15.2.3	<i>SP-INPUT</i> – Type of the set-point value default (internal or external).....	83
15.2.4	<i>SP-SCALE</i> – Scaling of the process set-point value (for external set-point value default only)	83
15.2.5	<i>P.CO-INIT</i> – Smooth switchover MANUAL-AUTOMATIC.....	84
15.3	<i>PID.PARAMETER</i> – Parameterizing the process controller	85
15.3.1	<i>DBND</i> – Insensitivity range (dead band)	85
15.3.2	<i>KP</i> – Amplification factor of the process controller	86
15.3.3	<i>TN</i> – Reset time of the process controller	87
15.3.4	<i>TV</i> – Hold-back time of the process controller	88
15.3.5	<i>X0</i> – Operating point of the process controller	89
15.3.6	<i>FILTER</i> – Filtering of the process actual value input	89
15.4	<i>P.Q’LIN</i> – Linearization of the process characteristic	90
15.5	<i>P.TUNE</i> – Self-optimization of the process controller	91
15.5.1	The operating mode of <i>P.TUNE</i>	92
15.5.2	Preparatory measure for execution of <i>P.TUNE</i>	92
15.5.3	Starting the function <i>P.TUNE</i>	93
16	AUXILIARY FUNCTIONS	95
16.1	Activating and deactivating auxiliary functions.....	95
16.1.1	Including auxiliary functions in the main menu.....	96
16.1.2	Removing auxiliary functions from the main menu.....	96
16.1.3	<i>CHARACT</i> – Selection of the transfer characteristic between input signal (set-point position) and stroke.....	97
16.1.4	<i>CUTOFF</i> – Sealing function	100
16.1.5	<i>DIR.CMD</i> – Effective direction of the position controller set-point value	102
16.1.6	<i>DIR.ACT</i> – Effective direction of the actuating drive	103
16.1.7	<i>SPLTRNG</i> – Signal split range	104
16.1.8	<i>X.LIMIT</i> – Limit of the mechanical stroke range	105
16.1.9	<i>X.TIME</i> – Limiting the control speed.....	106
16.1.10	<i>X.CONTROL</i> – Parameterization of the position controller.....	107
16.1.11	<i>P.CONTROL</i> – Setting up and parameterization of the process controller.....	109

16.1.12	SECURITY – Code protection for the settings	109
16.1.13	SAFEPOS – Inputting the safety position.....	110
16.1.14	SIG.ERROR – Configuration of signal level fault detection	110
16.1.15	BINARY.IN – Activation of the digital input.....	112
16.1.16	OUTPUT – Configuration of the outputs (option)	114
16.1.17	CAL.USER – Calibration of actual value and set-point value	120
16.1.18	SET.FACTORY – Reset to factory settings	124
16.2	SERVICE.BUES – Setting the service interface.....	124
16.2.1	EXTRAS – Setting the display.....	125
16.2.2	SERVICE	127
16.2.3	SIMULATION – Menu for simulation of set-point value, process and process valve.....	127
16.2.4	DIAGNOSE – Menu for monitoring valves (option).....	131
16.3	Manual configuration of X.TUNE	149
16.3.1	Description of the menu for the manual configuration of X.TUNE	149
17	ACCESS TO THE BÜS SERVICE INTERFACE	153
17.1	Setting options for start-up via Bürkert Communicator.....	154
18	OPERATING STRUCTURE AND FACTORY SETTING	156
19	ETHERNET/IP, PROFINET AND MODBUS TCP	172
19.1	Technical data	172
19.2	Interfaces.....	173
19.3	Industrial Ethernet.....	173
19.4	Differences between the fieldbus devices and devices without a field bus	175
19.5	Electrical connection	175
19.6	BUS.COMM – Settings on Type 8692, 8693	176
19.7	Bus status display.....	177
20	BÜS OPTION	178
20.1	Definition	178
20.2	Interfaces.....	178

MAN 1000327408 EN Version: N Status: RL (released | freigegeben) printed: 01.09.2023

20.3	Electrical installation - büS.....	178
20.3.1	Safety instructions.....	178
20.3.2	Electrical connection.....	179
20.3.3	Switch position (only type 8693).....	181
20.4	<i>BUS.COMM</i> – Settings on Type 8692, 8693.....	181
21	PROFIBUS DPV1.....	183
21.1	Technical data.....	183
21.2	Interfaces.....	184
21.3	Differences between the fieldbus devices and devices without a field bus.....	184
21.4	Electrical connections.....	185
21.4.1	Connection diagram PROFIBUS DPV1.....	186
21.4.2	Switch position (only type 8693).....	188
21.5	Start-up PROFIBUS DPV1.....	188
21.5.1	Start-up sequence.....	188
21.5.2	Safety settings if the bus fails.....	189
21.5.3	<i>BUS.COMM</i> – Settings on Type 8692/8693.....	189
21.6	Bus status display.....	189
22	MAINTENANCE AND TROUBLESHOOTING.....	190
22.1	Safety instructions.....	190
22.2	Maintenance.....	190
22.3	Fault messages.....	190
22.3.1	Error and warning messages while the <i>X.TUNE</i> function is running.....	191
22.3.2	Error messages while the <i>P.Q'LIN</i> function is running.....	192
22.3.3	Error messages while the <i>P.TUNE</i> function is running.....	192
22.4	Malfunctions.....	194
23	ACCESSORIES.....	195
23.1	Communications software.....	195
23.2	Download.....	195
23.3	USB interface.....	195

24	REMOVAL OF TYPE 8692, 8693	196
	24.1 Disconnecting the pneumatic connections	196
	24.2 Disconnecting electrical connections	197
	24.3 Removing Type 8692, 8693.....	197
25	PACKAGING AND TRANSPORT	198
26	STORAGE	198
27	DISPOSAL	198
28	SUPPLEMENTARY INFORMATION	199
	28.1 Selection criteria for continuous valves.....	199
	28.2 Properties of PID Controllers.....	201
	28.2.1 P-portion.....	201
	28.2.2 I-portion	202
	28.2.3 D-portion	203
	28.2.4 Superposition of P, I and D Portions.....	204
	28.2.5 Implemented PID controller	205
	28.3 Adjustment rules for PID Controllers	206
	28.3.1 Adjustment rules according to Ziegler and Nichols (oscillation method)	206
	28.3.2 Adjustment rules according to Chien, Hrones and Reswick (actuating variable jump method)	208
29	TABLES FOR CUSTOMER-SPECIFIC SETTINGS	210
	29.1 Table for your settings on the positioner type 8692.....	210
	29.1.1 Settings of the freely programmable characteristic.....	210
	29.2 Table for your settings on the process controller type 8693	211
	29.2.1 Set parameters of the process controller	211

1 OPERATING INSTRUCTIONS

The operating instructions describes the entire life cycle of the device. Keep these instructions in a location which is easily accessible to every user, and make these instructions available to every new owner of the device.

Important safety information.

Failure to observe these instructions may result in hazardous situations.

- ▶ The operating instructions must be read and understood.

1.1 Symbols

DANGER

Warns of an immediate danger.

- ▶ Failure to observe the warning may result in a fatal or serious injury.

WARNING

Warns of a potentially dangerous situation.

- ▶ Failure to observe the warning may result in serious injuries or death.

CAUTION

Warns of a possible danger.


- ▶ Failure to observe this warning may result in a moderate or minor injury.

NOTICE

Warns of damage to property.

- ▶ Failure to observe the warning may result in damage to the device or the equipment.

 indicates important additional information, tips and recommendations.

 refers to information in these operating instructions or in other documentation.

▶ designates instructions for risk prevention.

→ designates a procedure which you must carry out.

✔ markiert ein Resultat.

1.2 Definitions of terms

The term “device” used in these instructions applies to the compact position controller / process controller of type 8692/8693 REV.2.

2 AUTHORIZED USE

Non-authorized use of the positioner Type 8692 and the process controller Type 8693 can be dangerous to people, nearby equipment and the environment.

The device is designed to be mounted on pneumatic actuators of process valves for the control of media.

- ▶ In a potentially explosive atmosphere, Type 8692 and 8693 may be used only in accordance with the specification on the separate Ex type label. For the use, observe the ATEX manual with safety instructions for the Ex area.
- ▶ Devices without a separate Ex type label may not be used in a potentially explosive atmosphere.
- ▶ The device must not be exposed to direct sunlight.
- ▶ Do not remove the electronic module and display from the device.
- ▶ Pulsating direct voltage (rectified alternating voltage without smoothing) must not be used as operating voltage.
- ▶ During use observe the permitted data, the operating conditions and conditions of use specified in the contract documents and operating instructions, as described in chapter „10 Technical data“ in this manual and in the valve manual for the respective pneumatically actuated valve.
- ▶ The device may be used only in conjunction with third-party devices and components recommended and authorised by Bürkert.
- ▶ In view of the wide range of possible application cases, check whether the device is suitable for the specific application case and check this out if required.
- ▶ Correct transportation, correct storage and installation and careful use and maintenance are essential for reliable and faultless operation.
- ▶ Use the device only as intended.

3 BASIC SAFETY INSTRUCTIONS

These safety instructions do not consider any contingencies or incidents which occur during installation, operation and maintenance.

The operator is responsible for observing the location-specific safety regulations, also with reference to the personnel.



Risk of injury from high pressure in the system/device.

- ▶ Before working on the system or device, switch off the pressure and vent/drain lines.

Risk of injury due to electrical shock.

- ▶ Before reaching into the device or the equipment, switch off the power supply and secure to prevent reactivation.
- ▶ Observe applicable accident prevention and safety regulations for electrical equipment.

General hazardous situations.

To prevent injuries:

- ▶ The device must only be operated when in a perfect condition and in consideration of the operating instructions.
- ▶ Secure the system/device from unintentional actuation.
- ▶ Only trained technicians may perform installation and maintenance work.
- ▶ After an interruption in the power supply, ensure that the process is restarted in a controlled manner.
- ▶ Observe the general rules of technology.

To prevent damage to the device:

- ▶ When unscrewing and screwing the housing jacket (with transparent cap) in, do not hold the actuator but the electrical connection housing of Type 8692/8693.
- ▶ Do not supply the pilot air port with aggressive or flammable media or fluids.
- ▶ Do not make any internal or external changes on the device and do not subject it to mechanical stress.

NOTE

Electrostatic sensitive components/modules.

The device contains electronic components which react sensitively to electrostatic discharge (ESD). Contact with electrostatically charged persons or objects is hazardous to these components. In the worst case scenario, they will be destroyed immediately or will fail after start-up.

- ▶ Observe the requirements in accordance with EN 61340-5-1 to minimise or avoid the possibility of damage caused by sudden electrostatic discharge.
- ▶ Also ensure that you do not touch electronic components when the operating voltage is present.

4 GENERAL INFORMATION

4.1 Contact address

Germany

Bürkert Fluid Control System
Chr.-Bürkert-Str. 13-17
D-74653 Ingelfingen
E-mail: info@burkert.com

International

Contact addresses can be found on the final pages of the printed brief instructions (Quickstart).

And also on the internet at: www.burkert.com

4.2 Warranty

The warranty is only valid if the Type 8692/8693 are used as intended in accordance with the specified application conditions.

4.3 Master code

Operation of the device can be locked via a freely selectable user code. In addition, there is a non-changeable master code with which you can perform all operator actions on the device. This 4-digit master code can be found on the last pages of the printed brief instructions which are enclosed with each device.

If required, cut out the code and keep it separate from these operating instructions.

4.4 Information on the internet

The operating instructions and data sheets for Type 8692 and 8693 can be found on the Internet at: www.burkert.com

5 PRODUCT DESCRIPTION

5.1 General description

Position controller Type 8692 and process controller Type 8693 is a digital electropneumatic position controller for pneumatically actuated control valves with single-acting or double-acting actuators. The device incorporates the main function groups

- Position sensor
- Electro-pneumatic actuating system
- Microprocessor electronics

The position sensor measures the current positions of the continuous valve.

The microprocessor electronics continuously compare the current position (actual value) with a set-point position specified via the standard signal input and supplies the result to the position controller.

If there is a control difference, the electro-pneumatic actuating system corrects the actual position accordingly.

5.2 Properties

- **Variants**

- Position controller, Type 8692
 - Process controller with integrated position controller, Type 8693
- Types 8692 and 8693 are available for both single-acting and double-acting actuators.

- **Position sensor**

A non-contact and therefore wear-free position sensor.

- **Microprocessor-controlled electronics**

for signal processing, control and valve control.

- **Control module**

The device is operated by 4 keys. The 128 x 64 dot matrix graphics display enables you to display the set-point value or actual value and to configure and parameterize via menu functions.

- **Actuating system**

For low air flow rate:

The direct-acting model has an orifice of DN 0.6.

The actuating system for single-acting actuators consists of 2 solenoid valves and of 4 solenoid valves for double-acting actuators. In single-acting actuators, one valve serves for the aeration and another for the deaeration of the pneumatic actuator. Double-acting actuators feature 2 valves for aeration and deaeration.

For high air flow rate:

Orifice DN 2.5 is also available for pneumatic actuators (single-acting only).

The solenoid valves are equipped with diaphragm amplifiers to increase the maximum flow and therefore to improve the dynamics.

- **Position feedback (optional)**

Feedback is either via digital outputs or via an output (4...20 mA / 0...10 V).

When the valve reaches an upper or lower position, this position can be relayed e.g. to a PLC via digital outputs.

- **Pneumatic interfaces**

1/4" connections with different thread forms (G, NPT) or hose plug-in connection.

- **Electrical interfaces**

Circular plug-in connector or cable gland.

- **Housing**

The housing of Type 8692, 8693 is protected from excessively high internal pressure, e.g. due to leaks, by a pressure limiting valve.

5.3 Combinations with valve types and mounting variants

Position controller Type 8692 and process controller Type 8693 can be mounted on different process valves from the Bürkert range.

Angle seat valves, straight seat valves, control valves, diaphragm or ball valves are suitable (see chapter „5.3.1 Overview of mounting possibilities / features of valve types“).

- For single-acting actuators, only one chamber is aerated and deaerated during actuation. The generated pressure works against a spring. The piston moves until there is an equilibrium of forces between compressive force and spring force.
- For double-acting actuators the chambers on both sides of the piston are pressurized. In this case, one chamber is aerated when the other one is deaerated and vice versa.

There are two different procedures for valve installation.

In [Figure 1](#) shows two combination possibilities that serve as examples of valve installation in general. The two procedures are explained in chapter „11 Installation“ based on these examples.

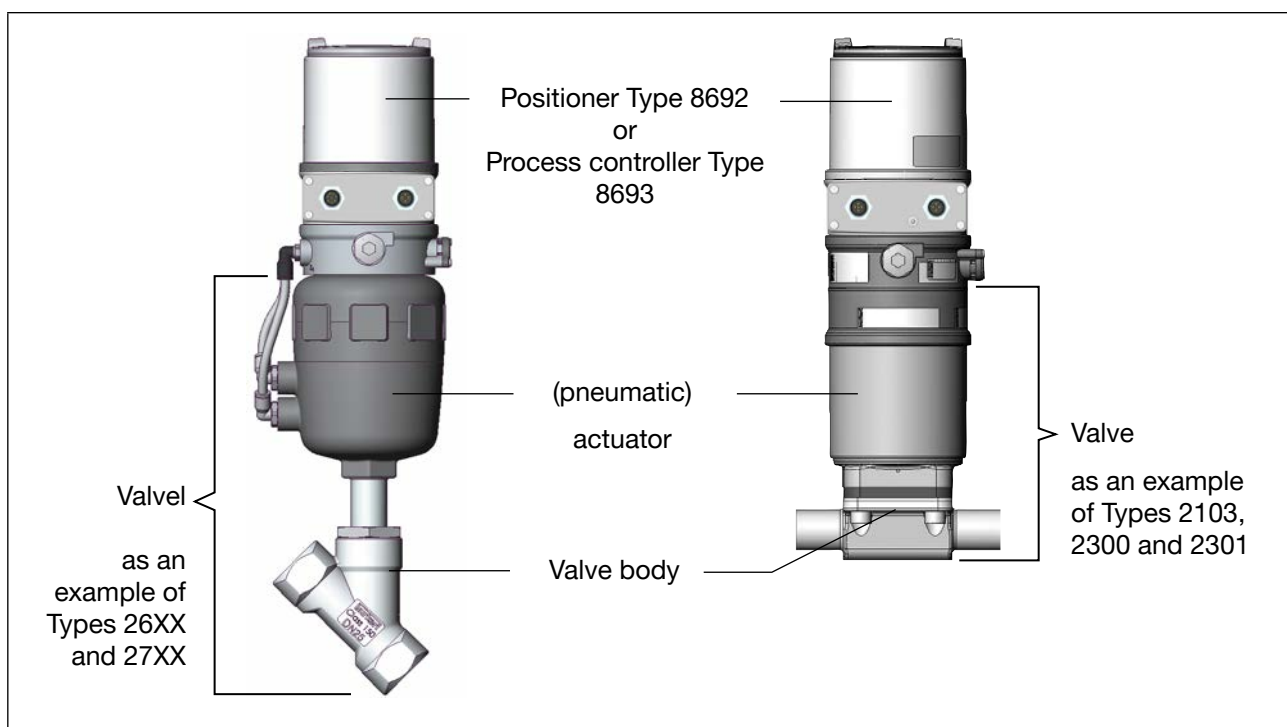


Figure 1: Mounting variants. Valve types with different installation

5.3.1 Overview of mounting possibilities / features of valve types

	Angle seat control valves / globe control valves	Diaphragm valves	Ball valves	Flap valves
Types	<ul style="list-style-type: none"> • 2702 • 2712 • 2300 • 2301 	<ul style="list-style-type: none"> • 2730 • 2103 • 2731 	<ul style="list-style-type: none"> • 2652 • 2655 • 2658 	<ul style="list-style-type: none"> • 2672 • 2675
Features	<ul style="list-style-type: none"> • incoming flow under seat • closes smoothly • straight flow path of the medium • self-adjusting stuffing box for high leak-tightness 	<ul style="list-style-type: none"> • medium is hermetically separated from the actuator and environment • cavity-free and selfdraining body design • any flow direction with low-turbulence flow • steam-sterilizable • CIP-compliant • closes smoothly • actuator and diaphragm can be removed when the body is installed 	<ul style="list-style-type: none"> • scrapable • minimum dead space • unaffected by contamination • little pressure loss compared to other valve types • seat and seal can be exchanged in the three-piece ball valve when installed <p>Information Can be used as process controller only</p>	<ul style="list-style-type: none"> • unaffected by contamination • little pressure loss compared to other valve types • inexpensive • low construction volume
Typical media	<ul style="list-style-type: none"> • water, steam and gases • alcohols, oils, propellants, hydraulic fluids • salt solutions, lyes (organic) • solvents 	<ul style="list-style-type: none"> • neutral gases and liquids • contaminated, abrasive and aggressive media • media of higher viscosity 	<ul style="list-style-type: none"> • neutral gases and liquids • clean water • slightly aggressive media 	<ul style="list-style-type: none"> • neutral gases and liquids • slightly aggressive media

Table 1: Overview of mounting possibilities / features of valve types



Different actuator sizes and valve orifices are available for each valve type. More precise specifications can be found on the respective data sheets. The product range is being continuously expanded.

5.4 Variants

5.4.1 Type 8692, position controller

The position of the actuator is regulated according to the set-point position. The set-point position is specified by an external standard signal (or via field bus).

The position controller Type 8692 is operated with a 128 x 64 dot matrix graphics display and a keypad with 4 keys.

5.4.2 Type 8693, process controller

Type 8693 also features a PID controller which, apart from actual position control, can also be used to implement process control (e.g. level, pressure, flow rate, temperature) in the sense of a cascade control.

The process controller Type 8693 is operated with a 128 x 64 dot matrix graphics display and a keypad with 4 keys.

The process controller is linked to a control circuit. The set-point position of the valve is calculated from the process set-point value and the process actual value via the control parameters (PID controller). The process set-point value can be specified by an external signal.

6 STRUCTURE AND FUNCTION

The position controller Type 8692 and the process controller Type 8693 consist of the micro-processor controlled electronics, the position sensor and the actuating system.

The device is designed using three-wire technology. The device is operated by 4 keys and a 128 x 64 dot matrix graphics display.

The pneumatic actuating system for single or double-acting actuators consists of 2 or 4 solenoid valves.

6.1 Representation

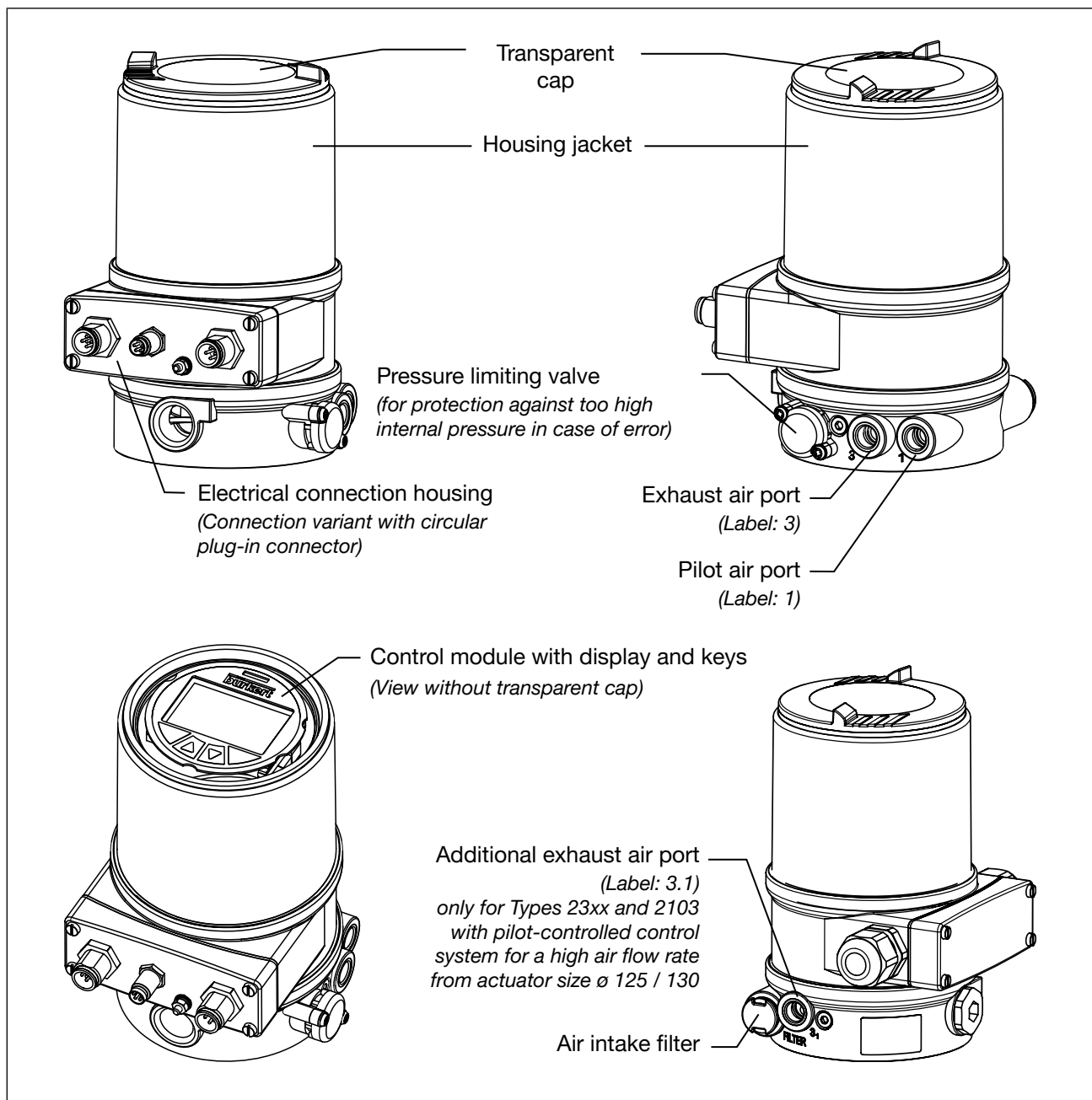


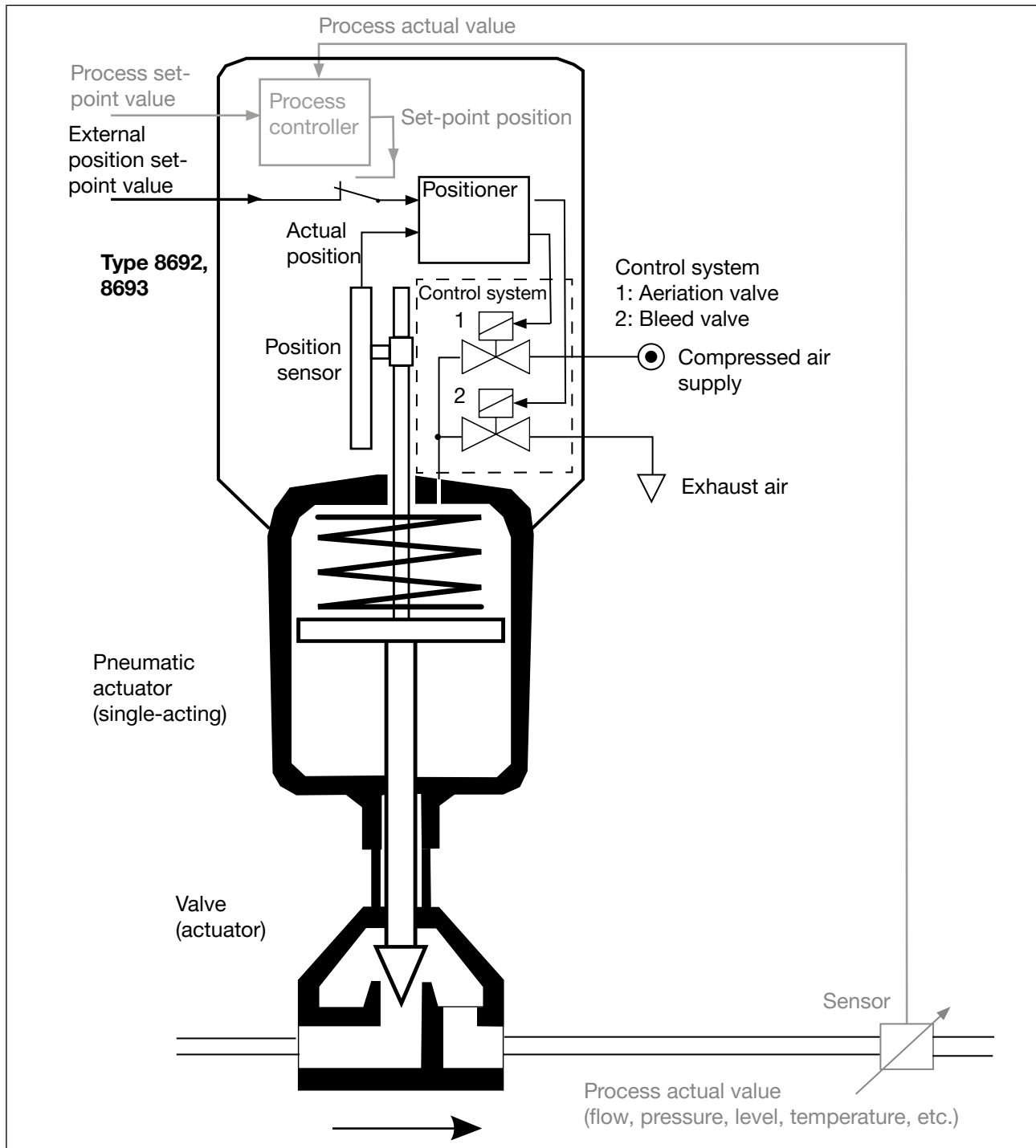
Figure 2: Structure, Type 8692, 8693

6.2 Function diagram

6.2.1 Diagram illustrating single-acting actuator

The black lines in „Figure 3: Function diagram“ specify the function of the position controller circuit in Type 8692.

The grey part of the diagram indicates the additional function of the superimposed process control circuit in Type 8693.



MAN 1000327408 EN Version: N Status: RL (released | freigegeben) printed: 01.09.2023

Figure 3: Function diagram

7 THE POSITION CONTROLLER TYPE 8692

The position sensor records the current position (*POS*) of the pneumatic actuator. The position controller compares this position actual value with the set-point value (*CMD*) which is specified as a standard signal. In case of a control difference (X_{d1}), a pulse-width modulated voltage signal is sent to the actuating system as an actuating variable. If there is a positive control difference in single-acting actuators, the aeration valve is controlled via output B1. If the control difference is negative, the bleed valve is controlled via output E1. In this way the position of the actuator is changed until control difference is 0. Z1 represents a disturbance variable.

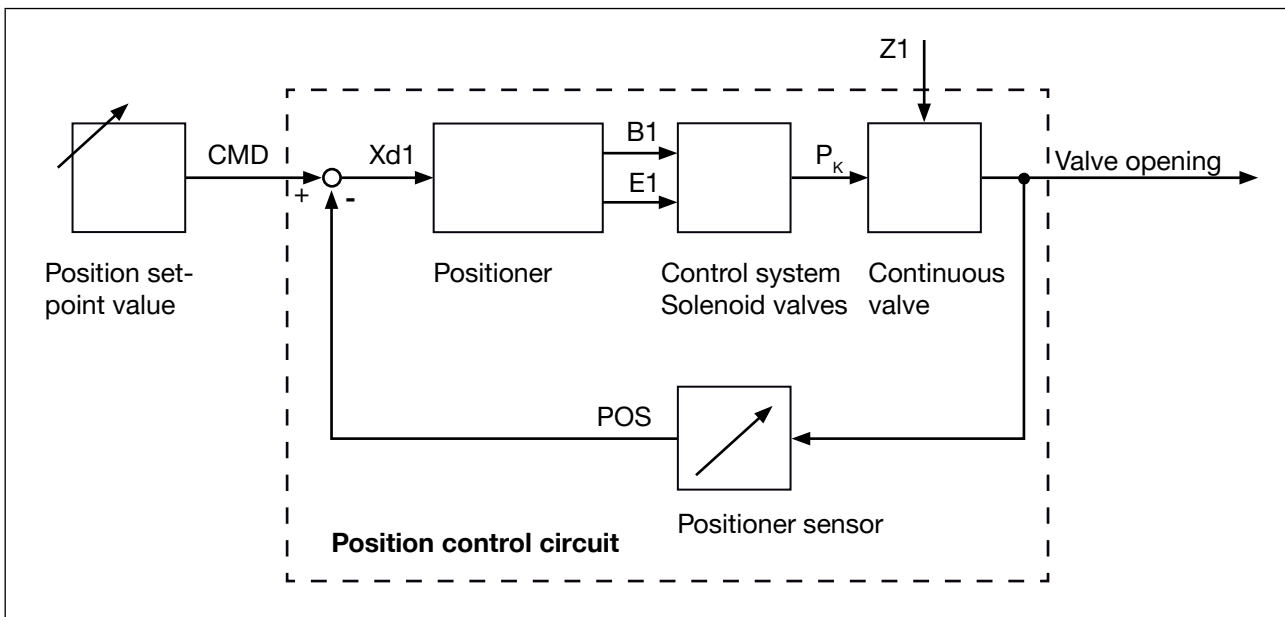


Figure 4: Position control circuit in Type 8692

7.1 Schematic representation of the position control

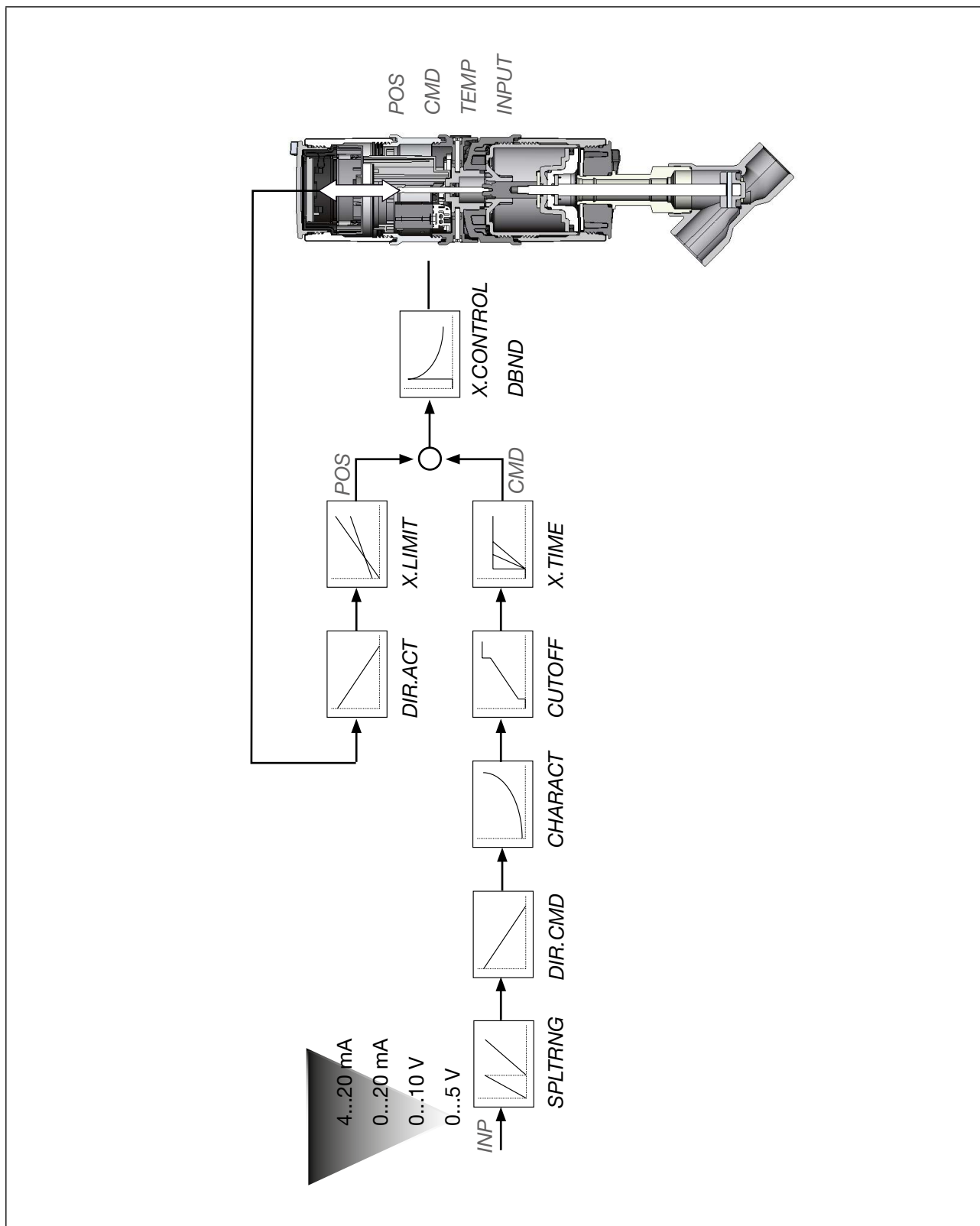


Figure 5: Schematic representation of position control

7.2 The position controller software

Configurable auxiliary function	Effect
Correction line to adjust the operating characteristic <i>CHARACT</i>	Selection of the transfer characteristic between input signal and stroke (correction characteristic).
Sealing function <i>CUTOFF</i>	Valve closes tight outside the control range. Specification of the value (as %), from which the actuator is completely deaerated (when 0%) or aerated (when 100%).
Effective direction of the controller set-point value <i>DIR.CMD</i>	Effective direction between input signal and set-point position.
Effective direction of the actuating drive <i>DIR.ACT</i>	Adjustment of the effective direction between aeration state of the actuator and the actual position.
Signal split range <i>SPLTRNG</i>	Splitting of the standard signal range to two or more position controllers.
Stroke limit <i>X.LIMIT</i>	Mechanical valve piston movement only within a defined stroke range.
Limit of the control speed <i>X.TIME</i>	Input of the opening and closing time for the total stroke.
Insensitivity range <i>X.CONTROL</i>	The position controller is initially actuated from a control difference to be defined.
Code protection <i>SECURITY</i>	Code protection for settings.
Safety position <i>SAFEPOS</i>	Definition of the safety position.
Signal level fault detection <i>SIG.ERROR</i>	Check the input signals for sensor break. Warning output on the display and approaching the safety position (if selected).
Digital input <i>BINARY. IN</i>	Switching between AUTOMATIC / MANUAL or approaching the safety position.
Analog feedback (option) <i>OUTPUT</i>	Feedback set-point value or actual value.
2 digital outputs (option) <i>OUTPUT</i>	Output of two selectable digital values.
User calibration <i>CAL.USER</i>	Change to the factory calibration of the signal input.
Factory settings <i>SET.FACTORY</i>	Reset to factory settings.
<i>SERVICE.BUES</i>	Configuring the bÜS service interface

Configurable auxiliary function	Effect
Setting display <i>EXTRAS</i>	Adjustment of the display of the process level.
<i>SERVICE</i>	For internal use only.
Simulation software <i>SIMULATION</i>	For simulation of the device functions.
<i>DIAGNOSE (option)</i>	Monitoring of processes.

Table 2: Position controller software. Configurable auxiliary functions

Hierarchical operating concept for easy operation on the following operating levels	
Process level	On the process level you switch between the AUTOMATIC and MANUAL operating states.
Setting level	On the setting level specify certain basic functions during start-up and configure auxiliary functions if required.

Table 3: The position controller software. Hierarchical operating concept

8 PROCESS CONTROLLER TYPE 8693

In the case of process controller Type 8693 the position control mentioned in chapter „7 The position controller Type 8692“ becomes the subordinate auxiliary control circuit; this results in a cascade control. The process controller in the main control circuit of Type 8693 has a PID function.

The process set-point value (SP) is specified as set-point value and compared with the actual value (PV) of the process variable to be controlled.

The position sensor records the current position (POS) of the pneumatic actuator. The position controller compares this position actual value with the set-point value (CMD) which is specified by the process controller.

In case of a control difference ($Xd1$), a pulse-width modulated voltage signal is sent to the actuating system as an actuating variable.

If there is a positive control difference in single-acting actuators, the aeration valve is controlled via output B1. If the control difference is negative, the bleed valve is controlled via output E1. In this way the position of the actuator is changed until control difference is 0. $Z2$ represents a disturbance variable.

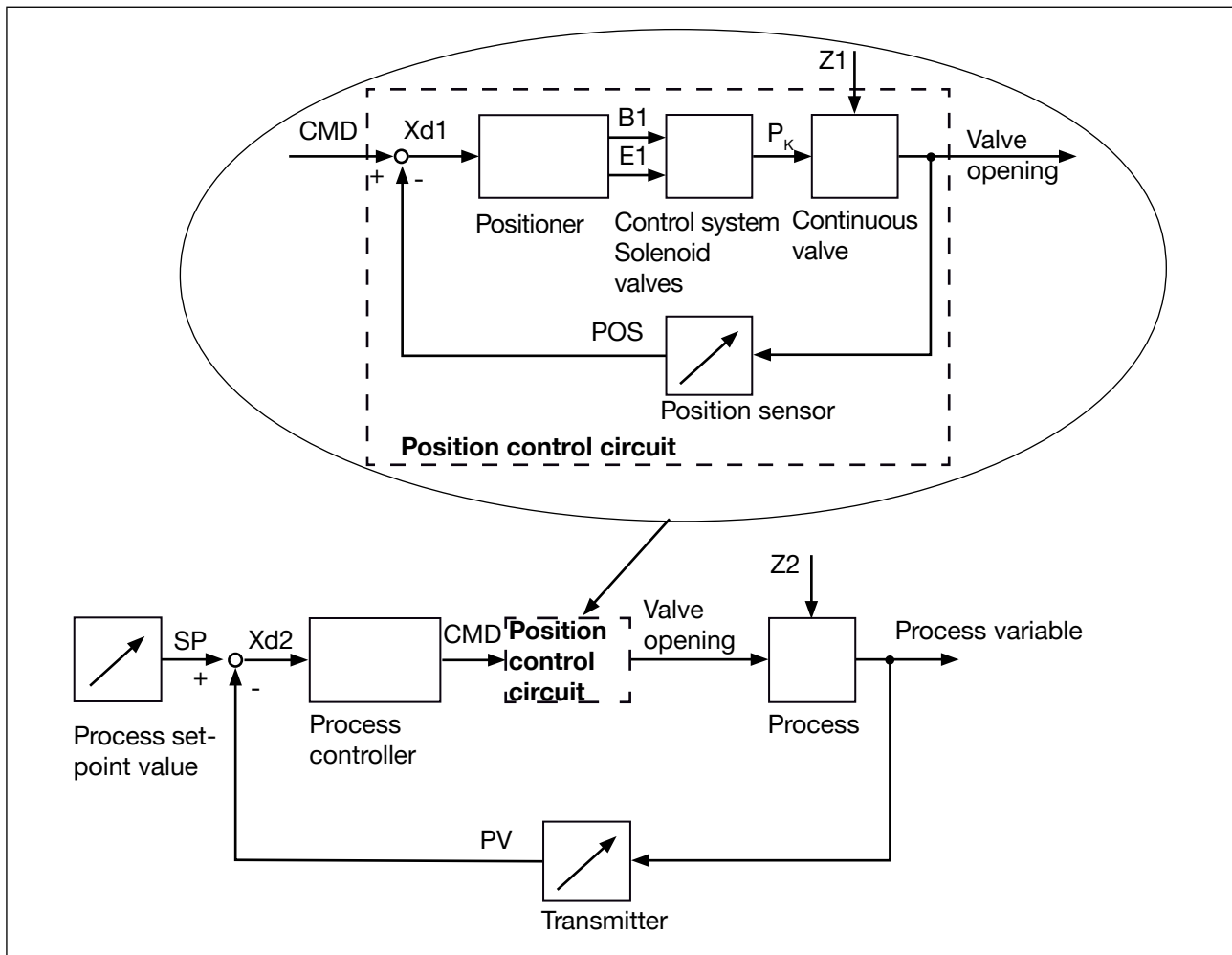


Figure 6: Signal flow plan of process controller

8.1 Schematic representation of process control

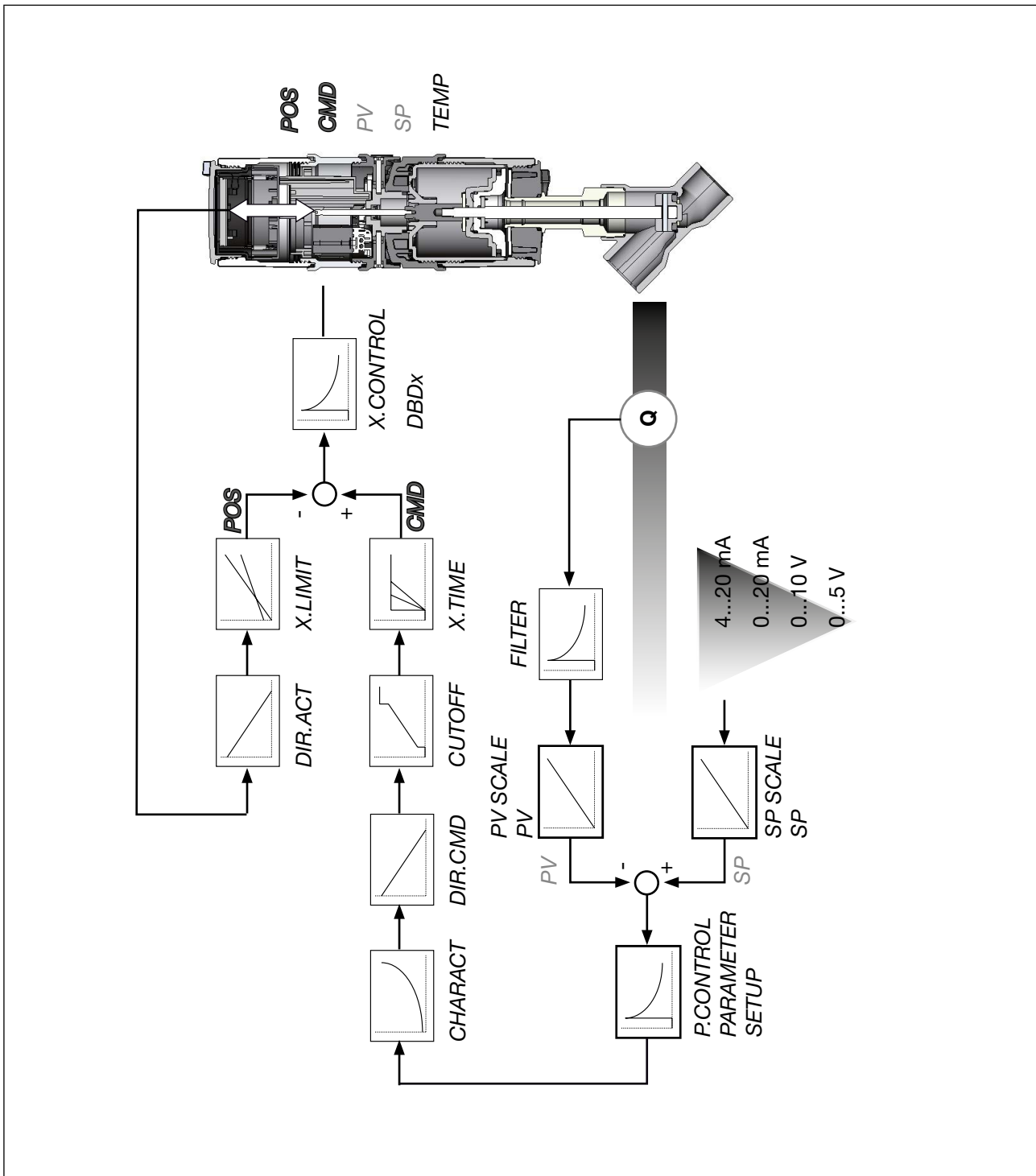


Figure 7: Schematic representation of process control

8.2 The position controller software

Configurable auxiliary function	Effect
Correction line to adjust the operating characteristic <i>CHARACT</i>	Selection of the transfer characteristic between input signal and stroke (correction characteristic).
Sealing function <i>CUTOFF</i>	Valve closes tight outside the control range. Specification of the value (as %), from which the actuator is completely deaerated (when 0%) or aerated (when 100%).
Effective direction of the controller set-point value <i>DIR.CMD</i>	Effective direction between input signal and set-point position.
Effective direction of the actuating drive <i>DIR.ACT</i>	Adjustment of the effective direction between aeration state of the actuator and the actual position.
Signal split range <i>SPLTRNG</i>	Splitting of the standard signal range to two or more position controllers.
Stroke limit <i>X.LIMIT</i>	Mechanical valve piston movement only within a defined stroke range.
Limit of the control speed <i>X.TIME</i>	Input of the opening and closing time for the total stroke.
Insensitivity range <i>X.CONTROL</i>	The position controller is initially actuated from a control difference to be defined.
Code protection <i>SECURITY</i>	Code protection for settings.
Safety position <i>SAFEPOS</i>	Definition of the safety position.
Signal level fault detection <i>SIG.ERROR</i>	Check the input signals for sensor break. Warning output on the display and approaching the safety position (if selected).
Digital input <i>BINARY.IN</i>	Switching between AUTOMATIC / MANUAL or approaching the safety position.
Analog feedback (option) <i>OUTPUT</i>	Feedback set-point value or actual value.
2 digital outputs (option) <i>OUTPUT</i>	Output of two selectable digital values.
User calibration <i>CAL.USER</i>	Change to the factory calibration of the signal input.
Factory settings <i>SET.FACTORY</i>	Reset to factory settings.
<i>SERVICE.BUES</i>	Configuring the büS service interface

Configurable auxiliary function	Effect
Setting display <i>EXTRAS</i>	Adjustment of the display of the process level.
<i>SERVICE</i>	For internal use only.
Simulation software <i>SIMULATION</i>	For simulation of the device functions.
<i>DIAGNOSE (option)</i>	Monitoring of processes.

Table 4: Position controller software. Configurable auxiliary functions

Functions and setting options of the process controller	
Process controller <i>P.CONTROL</i>	PID process controller is activated.
Adjustable parameters <i>P.CONTROL - PARAMETER</i>	Parameterization of the process controller Amplification factor, reset time, hold-back time and operating point.
Scalable inputs <i>P.CONTROL - SETUP</i>	Configuration of the process controller - Selection of the sensor input - Scaling of process actual value and process set-point value - Selection of the set-point value defaults.
Automatic sensor detection or manual sensor setting <i>P.CONTROL - SETUP - PV INPUT</i>	Sensor types Pt 100 and 4...20 mA are automatically detected or can be manually set via the operating menu.
Selection of the set-point value default <i>P.CONTROL - SETUP - SP INPUT</i>	Set-point value default either via standard signal input or via keys.
Process characteristic linearization <i>P.Q'LIN</i>	Function for the automatic linearization of the process characteristics.
Process controller optimization <i>P.TUNE</i>	Function for automatic optimization of the process controller parameters.

Table 5: The process controller software. Functions and setting options of the process controller

Hierarchical operating concept for easy operation on the following operating levels	
Process level	On the process level you switch between the AUTOMATIC and MANUAL operating states.
Setting level	On the setting level specify certain basic functions during start-up and configure auxiliary functions if required.

Table 6: The process controller software. Hierarchical operating concept

9 INTERFACES

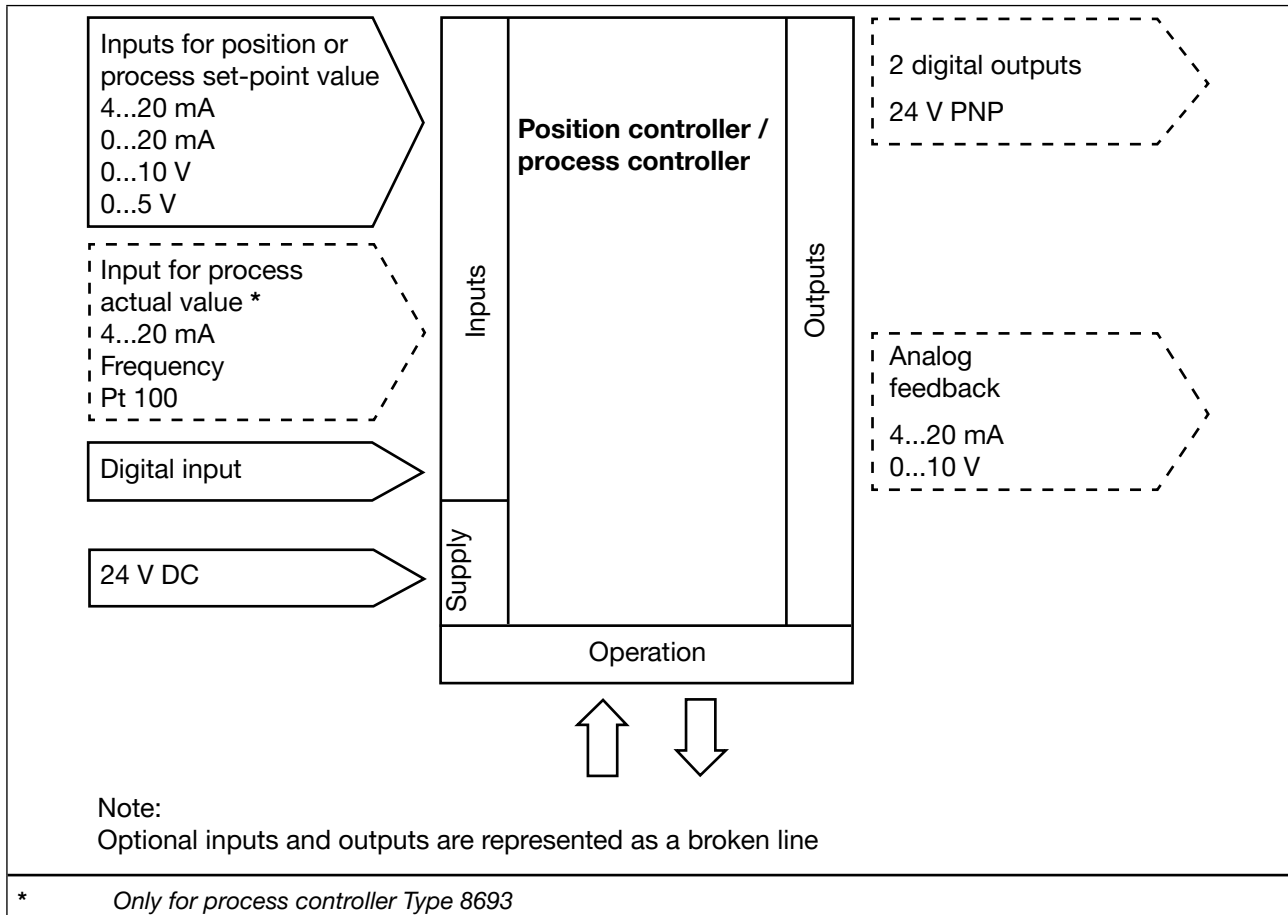


Figure 8: Interfaces of the position controller / process controller



Types 8692 and 8693 are 3-wire devices, i.e. the power (24 V DC) is supplied separately from the set-point value signal.

10 TECHNICAL DATA

10.1 Standards and directives

The device complies with the relevant EU harmonisation legislation. In addition, the device also complies with the requirements of the laws of the United Kingdom.

The harmonised standards that have been applied for the conformity assessment procedure are listed in the current version of the EU Declaration of Conformity/UK Declaration of Conformity.

10.2 Approvals

The product is approved for use in zone 2 and 22 in accordance with ATEX directive 2014/34/EU category 3GD.



Observe instructions on operation in the potentially explosive atmosphere. See supplementary ATEX instructions.

The product is cULus approved. Instructions on operation in the UL area see chapter „10.7 Electrical data“.

10.3 Operating conditions



WARNING!

Solar radiation and temperature fluctuations may cause malfunctions or leaks.

- ▶ If the device is used outdoors, do not expose it unprotected to the weather conditions.
- ▶ The permitted ambient temperature may not exceed the maximum value or drop below the minimum value.

Ambient temperature	Temperature range see type label
Degree of protection assessed by the manufacturer	IP65/IP67 according to EN 60529 *
assessed by UL	UL Type 4x Rating, indoor only *
Operating altitude	up to 2000 m above sea level
Relative air humidity	max. 90% at 55 °C (non condensing)

* Only for correctly connected cable or plug and sockets and in compliance with the exhaust air concept (see chapter „11.7 Pneumatic connection of the Type 8692, 8693“.

10.4 Type label

Description of the type label:

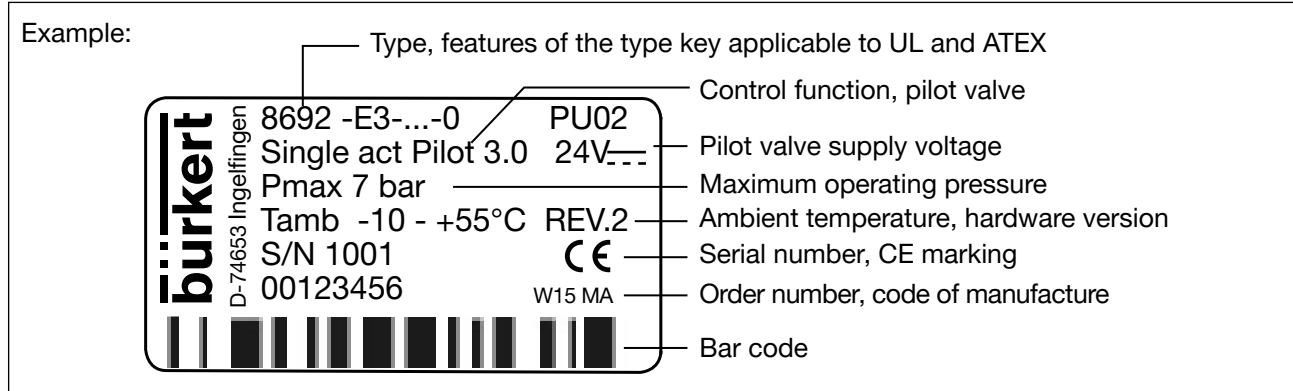


Figure 9: Type label (example)

10.4.1 UL additional label

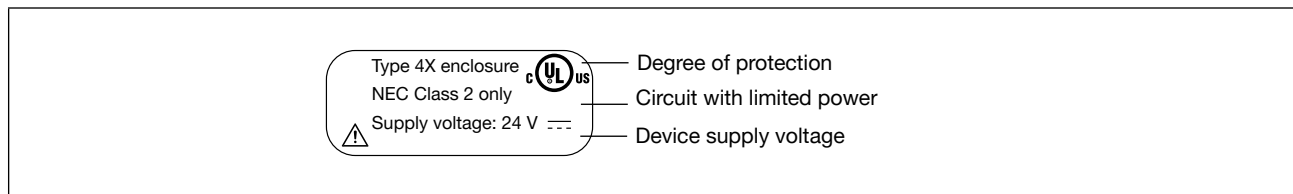


Figure 10: UL additional label (example)

10.5 Mechanical data

Dimensions	see data sheet
Housing material	outside: PPS, PC, VA, interior: PA 6; ABS
Sealing material	NBR/EPDM
Stroke range valve spindle	3...45 mm

10.6 Pneumatic data

Control medium	neutral gases, air Quality classes as per ISO 8573-1
Dust content	Quality class 7, max. particle size 40 µm, max. particle density 10 mg/m ³
Water content	Quality class 3, max. pressure dew point -20 °C (-4 °F) or min. 10°C (50 °F) below the lowest operating temperature
Oil content	Quality class X, max. 25 mg/m ³
Temperature range control medium	0...+50 °C (32...122 °F)

Pressure range control medium	3...7 bar
Air flow rate pilot valve	7 I _N /min (for aeration and deaeration) (Q _{Nn} - value according to definition for pressure drop from 7 to 6 bar absolute) optional: 130 I _N /min (for aeration and deaeration) (only single-acting connections)
Connections	Plug-in hose connector ø6 mm / 1/4" socket connection G1/8

10.7 Electrical data



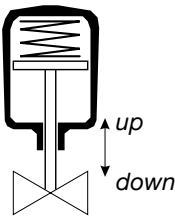
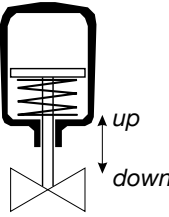
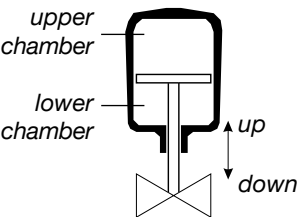
WARNING!

For UL approved components, only circuits of a limited power according to "NEC Class 2" may be used.

Protection class	III according to DIN EN 61140 (VDE 0140-1)	
Connections	Cable gland M16 x 1.5, size 22 (clamping area 5...10 mm) with connection terminals cable cross-sections rigid: 0.2...1.5 mm ² cable cross section flexible: 0.2...1.5 mm ² cable cross section AWG: 24...16 cable cross section, flexible, ferrule with plastic sleeve: 0.25...0.75 mm ² cable cross section, flexible, ferrule, without plastic sleeve: 0.25...1.5 mm ² or circular plug-in connectors (M12 x 1) (24 V DC, PROFIBUS DPV1, EtherNet/IP, PROFINET I/O, Modbus TCP)	
Operating voltage	24 V DC ± 10 %, max. residual ripple 10 %	
Power consumption	< 5 W	
Input data for actual value signal		
4...20 mA:	Input resistance	70Ω
	Resolution	12 bit
Frequency:	Measurement range	0...1000 Hz
	Input resistance	20 kΩ
	Resolution	1‰ of measurement value
	Input signal	> 300 mV _{ss}
	Waveform	Sine wave, square wave, triangle wave
Pt 100:	Measurement range	-20 to +220 °C (-4 to +428 °F)
	Resolution	< 0.1 °C
	Measurement current	< 1 mA
Input data for set-point value signal		
0/4...20 mA:	Input resistance	70Ω
	Resolution	12 bit
0...5/10 V:	Input resistance	22 kΩ
	Resolution	12 bit (only 11 bit for 0...5 V)

Analogue feedback max. current	10 mA (for voltage output 0...5/10 V)
Load	0...560 Ω (for current output 0/4...20 mA)
Digital outputs current limitation	galvanically isolated, PNP 100 mA, output is clocked if overload occurs
Digital input	PNP 0...5 V = logical "0", 10...30 V = logical "1" inverted input reversed accordingly (input current < 6 mA)
Communications interface	Connection to PC with USB bÜS interface set
Communications software	Bürkert Communicator

10.8 Safety end positions after failure of the electrical or pneumatic auxiliary power

Actuator system	Designation	Safety end positions after failure of the	
		electrical auxiliary power	pneumatic auxiliary power
	single-acting Control function A	down	control system for high air flow rate (DN2.5): down control system for low air flow rate (DN0.6): not defined
	single-acting control function B	up	control system for high air flow rate (DN2.5): up control system for low air flow rate (DN0.6): not defined
	double-acting Control function I	down/up (depending on the installation of the pneumatic connection)	not defined

MAN 1000327408 EN Version: N Status: RL (released | freigegeben) printed: 01.09.2023

11 INSTALLATION



Only for position controllers and process controllers without pre-assembled process valve.



DANGER

Risk of injury from high pressure in the system/device.

- ▶ Before working on the system or device, switch off the pressure and vent/drain lines.

Risk of injury due to electrical shock.

- ▶ Before reaching into the device or the equipment, switch off the power supply and secure to prevent reactivation.
- ▶ Observe applicable accident prevention and safety regulations for electrical equipment.



WARNING

Risk of injury from improper assembly.

- ▶ Assembly may be carried out by authorized technicians only and with the appropriate tools.

Risk of injury from unintentional activation of the system and uncontrolled restart.

- ▶ Secure system against unintentional activation.
- ▶ Following assembly, ensure a controlled restart.

11.1 Installation of devices for the Ex area

When installing devices in the potentially explosive atmosphere, observe the “ATEX manual for use in the Ex area” enclosed with the Ex-devices.

11.2 Type 2103, 2300 and 2301

NOTE!

When installing on process valves with welded connections, follow the installation instructions in the operating instructions of the process valve.

Procedure:

1. Attaching the switch spindle
see [Seite 34](#)
2. Installing the form seal
see [Seite 35](#)



Not required for actuators with attached control or for actuators on which a control has already been attached.

1. Installing Type 8692, 8693
see [Seite 36](#)

11.2.1 Install switch spindle

DANGER

Risk of injury from high pressure in the system/device.

- ▶ Before loosening the lines and valves, turn off the pressure and vent the lines.

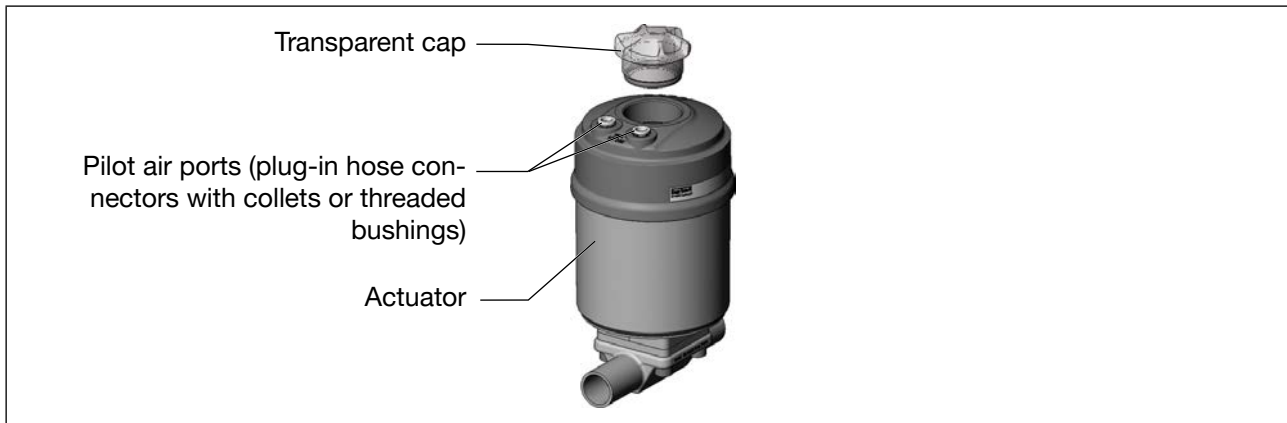


Figure 11: Installing the switch spindle for process valves Types 2103, 2300 and 2301; remove transparent cap and pilot air ports

→ Unscrew the transparent cap on the actuator and unscrew the position display (yellow cap) on the spindle extension (if present).

→ For variant with plug-in hose connector, remove the collets (white nozzles) from both pilot air ports (if present).

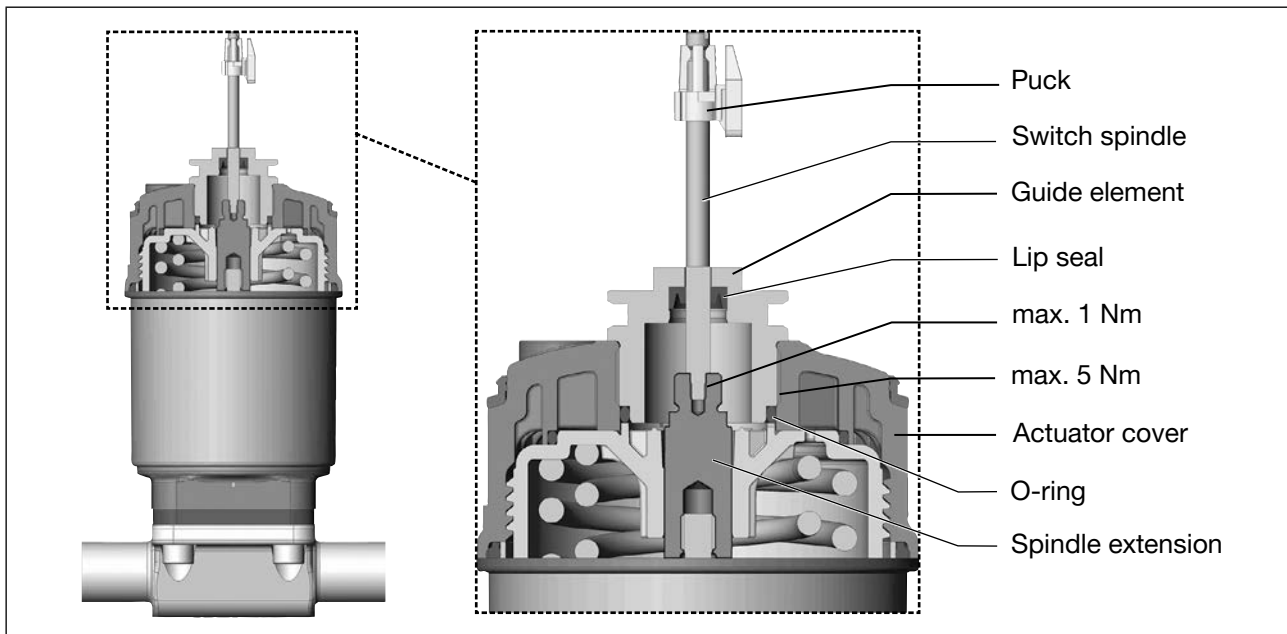


Figure 12: Attaching the switch spindle for process valves Types 2103, 2300 and 2301

NOTE

Improper installation may damage the lip seal in the guide element.

The lip seal is already be pre-assembled in the guide element and must be “locked into position” in the undercut.

- ▶ When installing the switch spindle, do not damage the lip seal.

→ Push the switch spindle through the guide element.

NOTE

Screw locking paint may contaminate the lip seal.

- ▶ Do not apply any screw locking paint to the switch spindle.

→ To secure the switch spindle, apply some screw locking paint (Loctite 290) in the tapped bore of the spindle extension in the actuator.

→ Check that the O-ring is correctly positioned.

→ Screw the guide element to the actuator cover (maximum tightening torque: 5 Nm).

→ Screw switch spindle onto the spindle extension. To do this, there is a slot on the upper side (maximum tightening torque: 1 Nm).

→ Push puck onto the switch spindle and lock into position.

11.2.2 Install form seal

→ Pull the form seal onto the actuator cover (smaller diameter points upwards).

→ Check that the O-rings are correctly positioned in the pilot air ports.



When the Type 8692/8693 is being installed, the collets of the pilot air ports must not be fitted to the actuator.

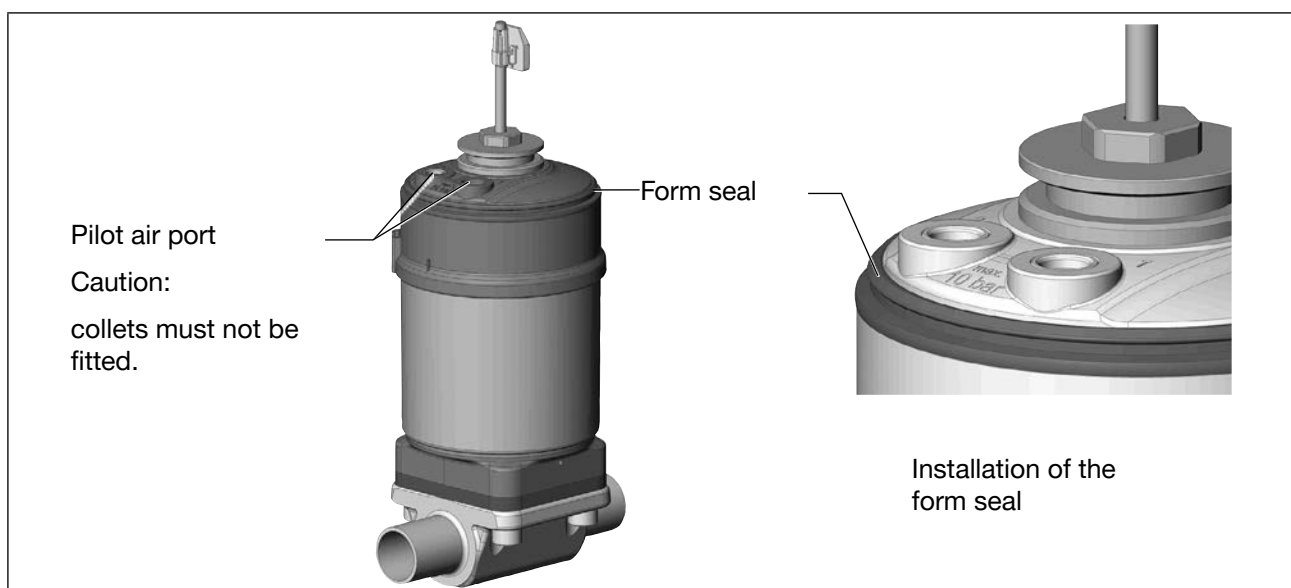


Figure 13: Installing the form seal for process valves Types 2103, 2300 and 2301

11.2.3 Install Type 8692/8693

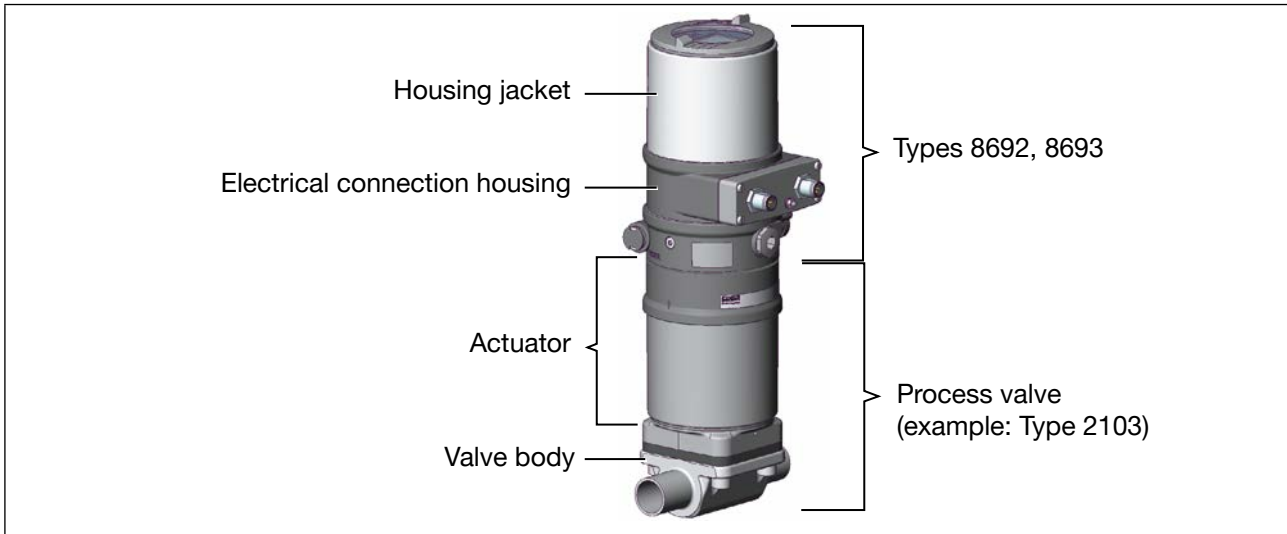


Figure 14: Installation of Type 8692/8693 on process valves, example showing Type 2301

! During the installation, the collets of the pilot air ports must not be fitted to the actuator.

→ Aligning actuator with type 8692/8693:

1. Align the pilot air ports of the actuator with the connection pieces of Type 8692/8693 (see Figure 15).

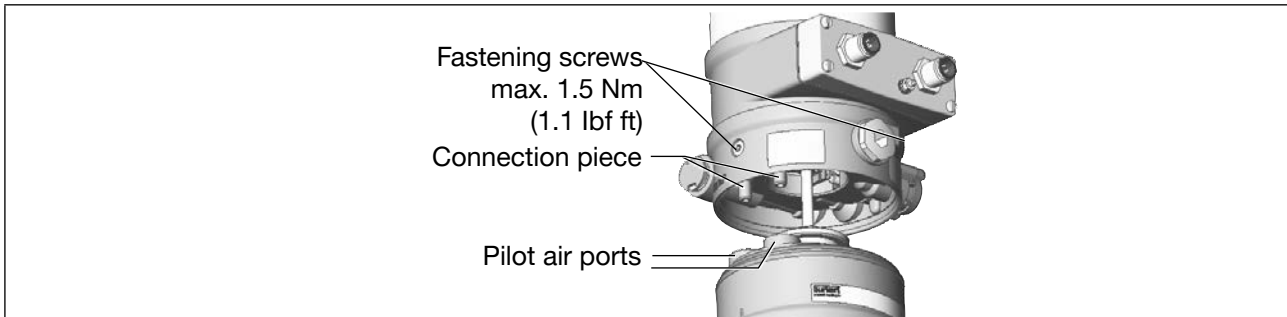


Figure 15: Aligning the pilot air ports

2. Align the puck of the actuator with the guide rail of Type 8692/8693 (see Figure 16)

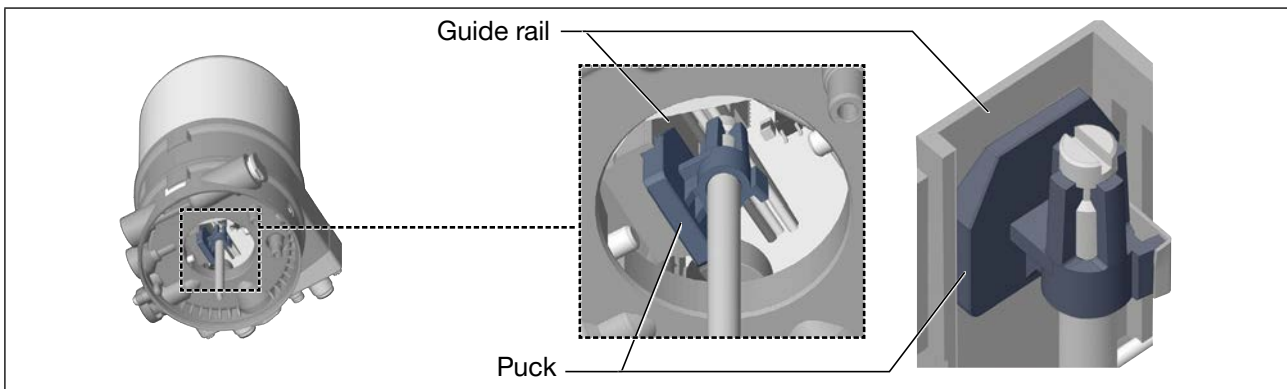


Figure 16: Aligning the puck

NOTE

Damage to the PCB or malfunction.

- ▶ Ensure that the puck lies flat on the guide rail.

→ Push Type 8692/8693 without turning it onto the actuator until no gap is visible on the form seal.

NOTE

To comply with the degree of protection IP65/IP67, do not fasten the fastening screws too tightly.

- ▶ Maximum tightening torque: 1.5 Nm.

→ Attach Type 8692/8693 to the actuator using the two side fastening screws. In doing so, tighten the screws only hand-tight (max. tightening torque: 1.5 Nm (1.1 lbf ft)) .

11.3 Installation on process valves, series 26xx and 27xx

Procedure:

1. Attaching the switch spindle
Not required for actuators with attached control or for actuators on which a control has already been attached.
2. Installing Type 8692, 8693

11.3.1 Install switch spindle

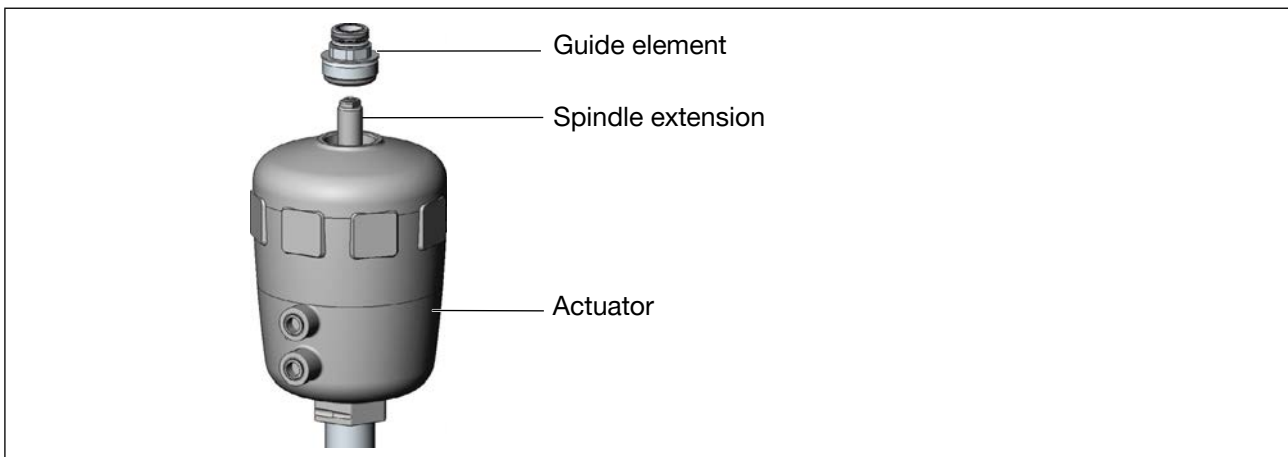


Figure 17: Installing the switch spindle for process valves belonging to series 26xx and 27xx; remove guide element and intermediate ring.

- Unscrew the guide element from the actuator (if present).
- Remove intermediate ring (if present).

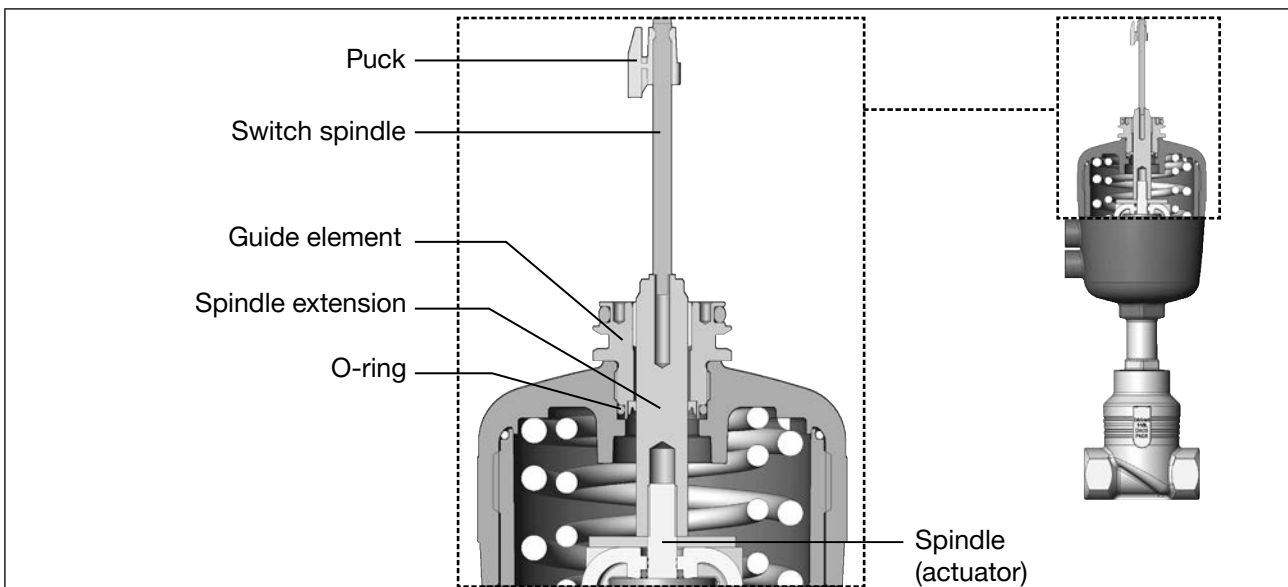


Figure 18: Installing the switch spindle for process valves belonging to series 26xx and 27xx

- Press the O-ring downwards into the cover of the actuator.

- Actuator size 125 and bigger with large air flow rate:
remove existing spindle extension and replace with the new one. To do this, apply some screw locking paint (Loctite 290) in the tapped bore of the spindle extension.
- With a face pin wrench (journal \varnothing : 3 mm / journal gap: 23.5 mm)
Screw the guide element into the cover of the actuator (tightening torque: 8.0 Nm).
- To secure the switch spindle, apply some screw locking paint (Loctite 290) to the thread of the switch spindle.
- Screw the switch spindle onto the spindle extension (maximum tightening torque: 1 Nm (0.74 lbf ft)).
To do this, there is a slot on the upper side.
- Push the puck holder onto the switch spindle until it engages.

11.3.2 Install Type 8692/8693

- Place Type 8692/8693 onto the actuator. In doing so, align the puck of the actuator with the guide rail of Type 8692/8693 (see [Figure 19](#)).

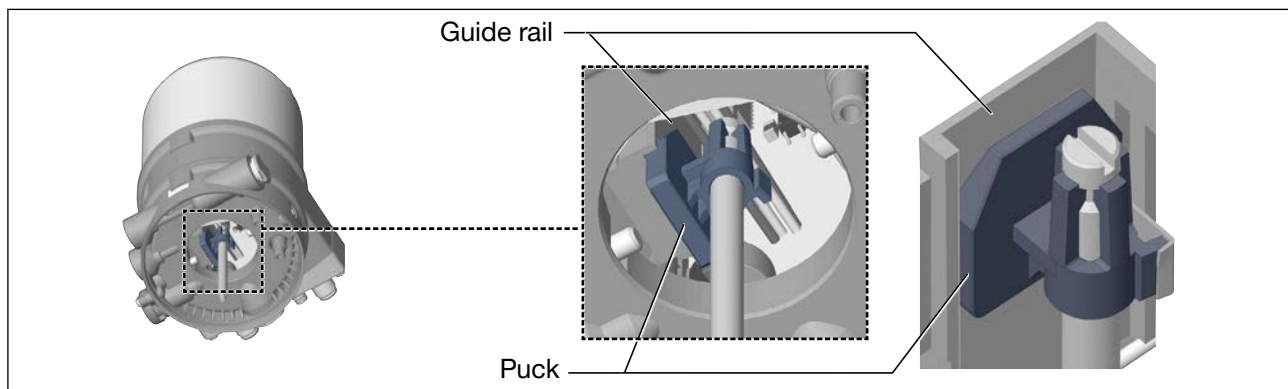


Figure 19: Aligning the puck

NOTE

Damage to the PCB or malfunction.

- ▶ Ensure that the puck lies flat on the guide rail.

- Press Type 8692/8693 all the way down as far as the actuator and turn it into the required position.



Ensure that the pneumatic connections of Type 8692, 8693 and those of the valve actuator are situated preferably vertically one above the other (see [Figure 20](#)).

NOTE

To comply with the degree of protection IP65/IP67, do not fasten the fastening screws too tightly.

- ▶ Maximum tightening torque: 1.5 Nm (1.1 lbf ft).

- Attach Type 8692/8693 to the actuator using the two side fastening screws. In doing so, tighten the screws only hand-tight (max. tightening torque: 1.5 Nm (1.1 lbf ft)) (see [Figure 20](#)).

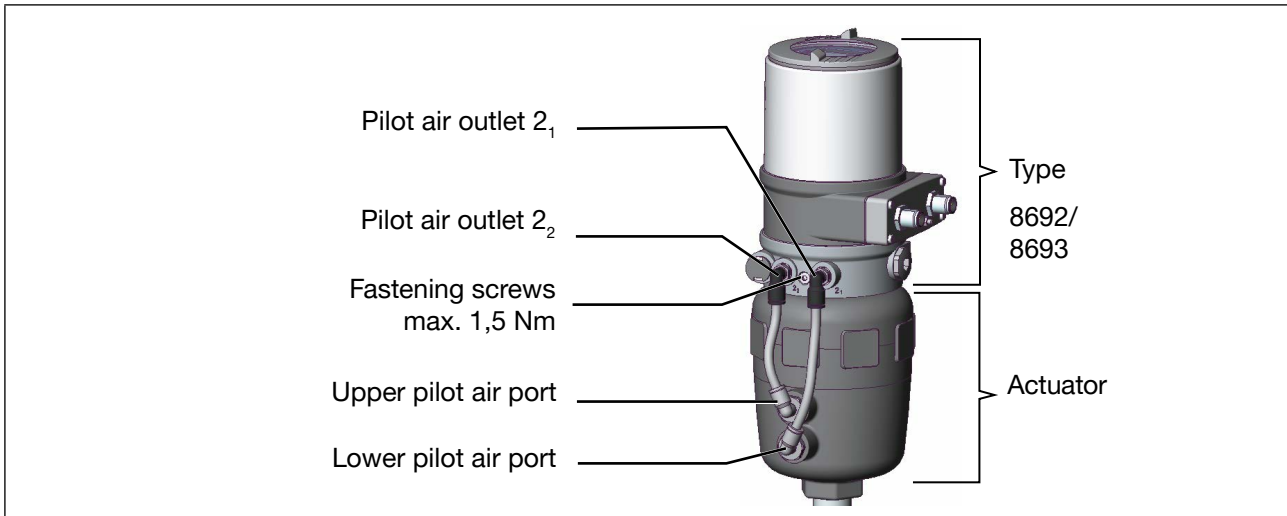


Figure 20: Installation of Type 8692/8693 on process valves belonging to series 26xx and 27xx

Establish the pneumatic connection between Type 8692/8693 and the actuator:

- Screw the plug-in hose connectors onto the Type 8692/8693 and the actuator.
- Observe the pneumatic connection that matches the desired control function. See [Table 8](#).
- Using the hoses supplied in the accessory kit, make the pneumatic connection between Type 8693/8693 and the actuator.

NOTE

Damage or malfunction due to ingress of dirt and moisture.

- ▶ To comply with the degree of protection IP65/IP67, connect the pilot air outlet which is not required to the free pilot air port of the actuator or seal with a plug.



„In rest position” means that the pilot valves of Type 8692, 8693 are isolated or not actuated.



If the ambient air is humid, a hose can be connected between pilot air outlet 22 of the positioner / process controller and the unconnected pilot air port of the actuator for control function A or control function B.

As a result, the spring chamber of the actuator is supplied with dry air from the vent duct of Type 8692/8693.

Control function		Pneumatic connection Type 8692, 8693 with actuator	
		Pilot air outlet. Types 8692 and 8693	Pilot air port actuator
A	Process valve closed in rest position (by spring force)	2 ₁	lower pilot air port of the actuator
		2 ₂	should be connected to the upper pilot air port of the actuator
B	Process valve open in rest position (by spring force)	2 ₁	upper pilot air port of the actuator
		2 ₂	should be connected to the lower pilot air port of the actuator
I	Process valve closed in rest position	2 ₁	lower pilot air port of the actuator
		2 ₂	upper pilot air port of the actuator
	Process valve open in rest position	2 ₁	upper pilot air port of the actuator
		2 ₂	lower pilot air port of the actuator

Table 8: Pneumatic connection to actuator

11.4 Installation on rotary actuators from third party manufacturers

→ The magnetic transmitter for the sensor must be assembled on the spindle adapter and the adapter kit must be assembled on the actuator (see adapter kit assembly instructions).

→ Press the angle of rotation sensor into the sensor holder from above until it sits flush.

NOTE

Damage to the sensor cable.

- ▶ Ensure that the sensor cable is not damaged during assembly.

→ Press down the device as far as the actuator.

NOTE

Damage or malfunction due to ingress of dirt or moisture.

To observe the degree of protection IP65 or IP67:

- ▶ Tighten fastening screws only with a tightening torque of max. 0.5 Nm.

→ Attach the device to the actuator using both lateral fastening screws. In doing so, tighten the screws only lightly (maximum tightening torque: 0.5 Nm).

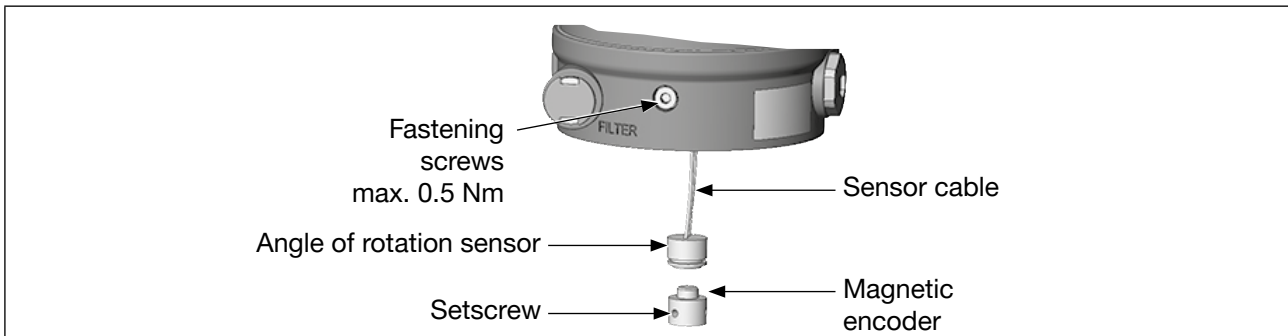


Figure 21: Installation on rotary actuators

11.5 Rotating the actuator module

Type 8692, 8693 with attached actuator is designated as the actuator module.

Following installation of the process valve, if the display of Type 8692, 8693 is only partially visible or the connection cables or hoses are difficult to fit, the actuator module can be rotated into a suitable position.



With diaphragm valves it is not possible to turn the actuator module.



Process valves Types 2300 and 2301: Only the position of the entire actuator module relative to the valve body can be rotated. Type 8692/8693 cannot be rotated contrary to the actuator.



The process valve must be in the open position to turn the actuator module.



DANGER

Risk of injury from high pressure in the system/device.

- ▶ Before loosening the lines and valves, turn off the pressure and vent the lines.

Procedure:

- Clamp valve body in a holding device (only required if the process valve has not yet been installed).
- Control function A: Open process valve.

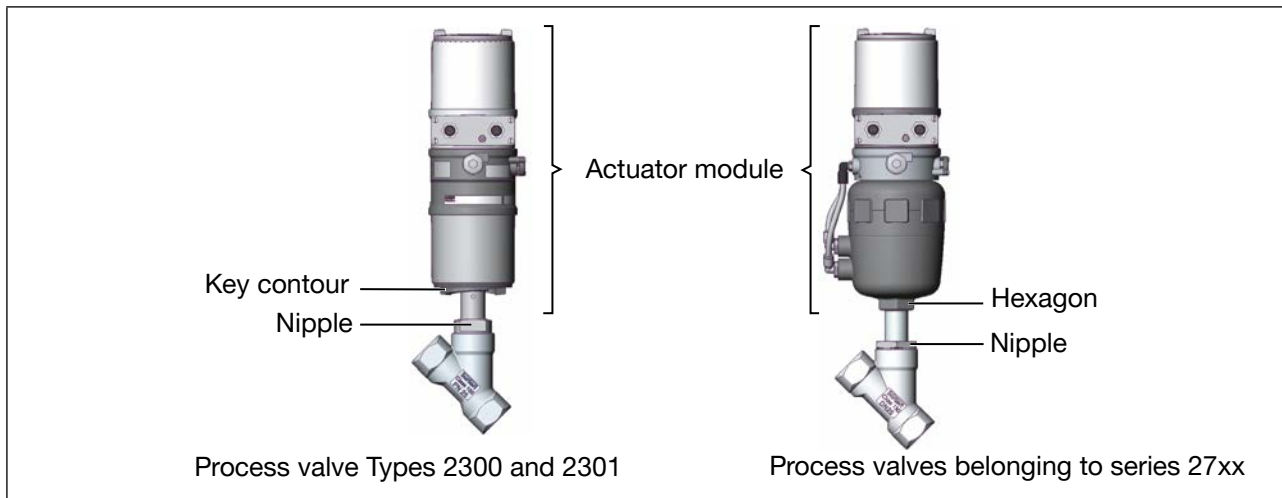


Figure 22: Rotating the actuator module

- Using a suitable open-end wrench, counter the wrench flat on the pipe.
- Process valves Types 2300 and 2301:
Fit special key exactly in the key contour on the underside of the actuator.
(The special key is available from the Bürkert sales office. Order number 665702).
- Process valves belonging to series 27xx:
Place suitable open-end wrench on the hexagon of the actuator.

! WARNING

Risk of injury from discharge of medium and pressure.

If the direction of rotation is wrong, the body interface may become detached.

- ▶ The actuator module must only be turned in the specified direction (see Figure 23)!

- Process valves Types 2300 and 2301:
Rotate clockwise (as seen from below) to bring the actuator module into the required position.
- Process valves belonging to series 27xx:
Rotate counter-clockwise (as seen from below) to bring the actuator module into the required position.

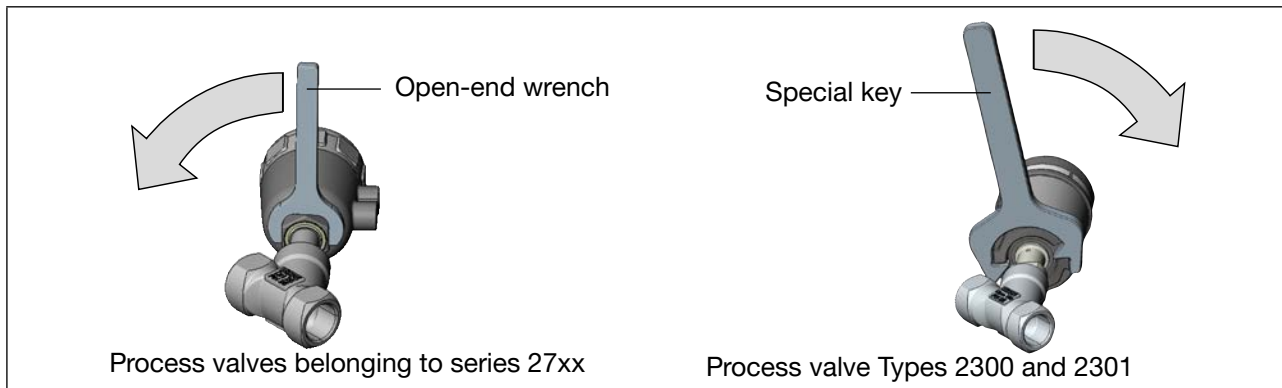


Figure 23: Specified direction of rotation and tool for turning the actuator module

MAN 1000327408 EN Version: N Status: RL (released | freigegeben) printed: 01.09.2023

11.6 Rotating the Types 8692/8693 for process valves belonging to series 26xx and 27xx

If the connecting cables or hoses cannot be fitted properly following installation of the process valve, the Type 8692/8693 can be rotated contrary to the actuator.

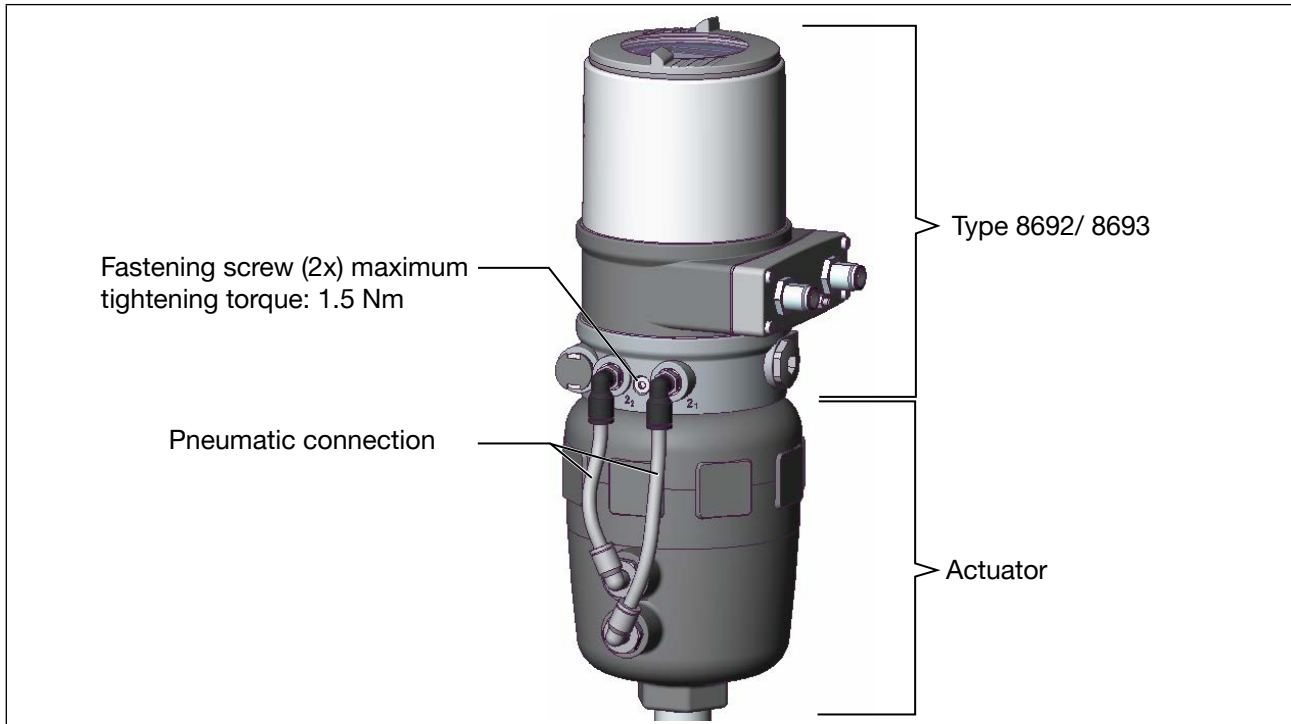


Figure 24: Rotating the Type 8692/8693 for process valves belonging to series 26xx and 27xx

Procedure:

- Loosen the pneumatic connection between the Type 8692/8693 and the actuator.
- Loosen the fastening screws (hexagon socket wrench size 3.0).
- Rotate the Type 8692/8693 into the required position.

NOTE

To comply with the degree of protection IP65/IP67, do not fasten the fastening screws too tightly.

- ▶ Maximum tightening torque: 1.5 Nm.

- Tighten the fastening screws hand-tight only (maximum tightening torque: 1.5 Nm).
- Re-attach the pneumatic connections between the Type 8692/8693 and the actuator. If required, use longer hoses.

11.7 Pneumatic connection of the Type 8692, 8693

DANGER

Risk of injury from high pressure in the system/device.

- ▶ Before working on the system or device, switch off the pressure and vent/drain lines.

Observe the following for the proper functioning of the device:

- ▶ The installation must not cause back pressure to build up.
- ▶ To make the connection, select a hose with sufficient cross section.
- ▶ Design the exhaust air line in such a way that no water or other liquid can get into the device through the exhaust air port (3 or 3.1).

Exhaust air concept:

- ▶ In compliance with the degree of protection IP67, an exhaust air line must be installed in the dry area.
- ▶ Always maintain an applied control pressure of at least 0.5...1 bar above the pressure which is required to move the pneumatic actuator to its end position. This ensures that the control behavior is not negatively affected in the upper stroke range on account of too little pressure difference.
- ▶ During operation, keep the fluctuations of the control pressure as low as possible (max. $\pm 10\%$). If fluctuations are greater, the control parameters measured with the X.TUNE function are not optimum.

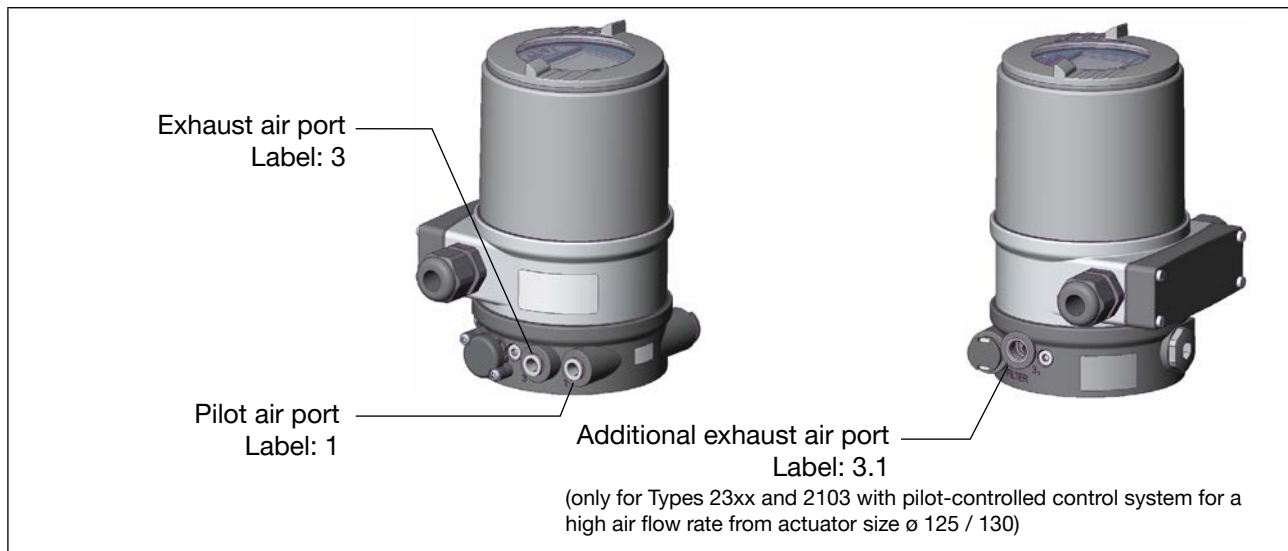


Figure 25: Pneumatic connection

Procedure:

- Connect the control medium to the pilot air port (1) (3...7 bar; instrument air, free of oil, water and dust).
- Mount the exhaust air line or a silencer on the exhaust air port (3) and, if present, on the exhaust air port (3.1).

11.8 Model with high air flow rate

In the variant with high air rate, the actuator can be moved to its end position without electrical power. The actuator moves from its rest position to the end position. To do this, the pilot valves must be activated with a screwdriver.

11.8.1 Manual activation of the actuator via pilot valves

The actuator can be moved from the rest position to its end position and back without electrical power. To do this, the pilot valves must be activated with a screwdriver.

NOTE

The hand lever can be damaged if it is pressed and turned at the same time.

- ▶ Do not press the hand lever while turning it.

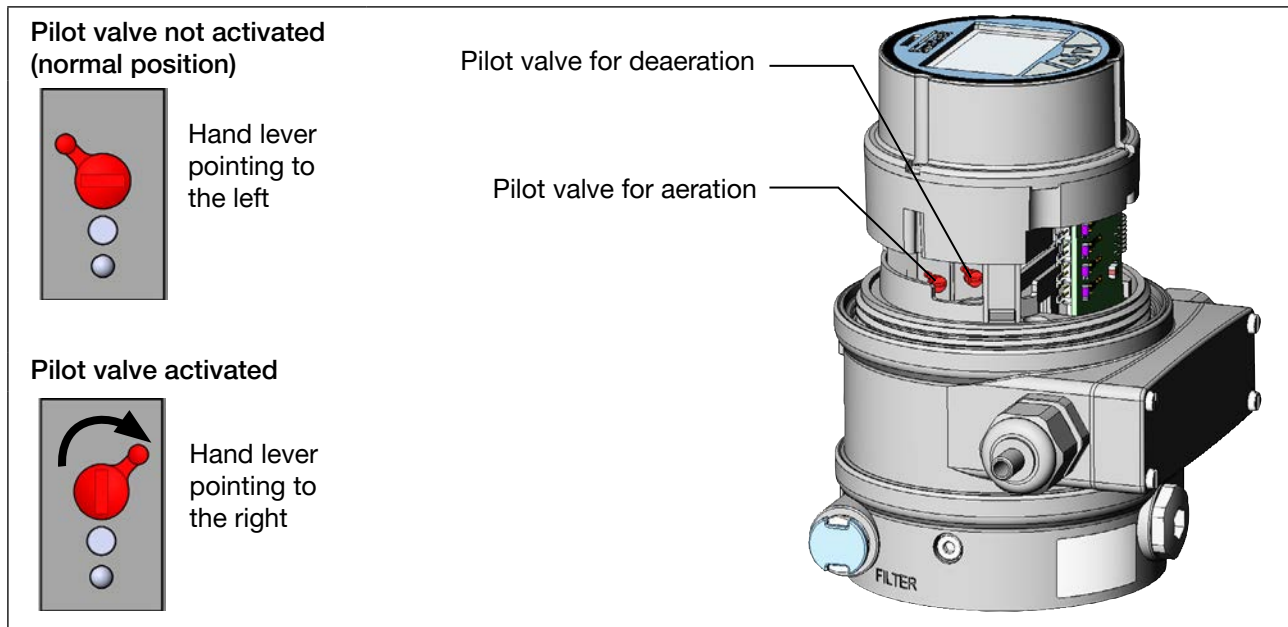


Figure 26: Pilot valves for aeration and deaeration of the actuator

Move the actuator to the end position

Turn the hand lever to the right with a screwdriver.

- Please note:
- Do not press the lever while turning it
 - Follow the order described below

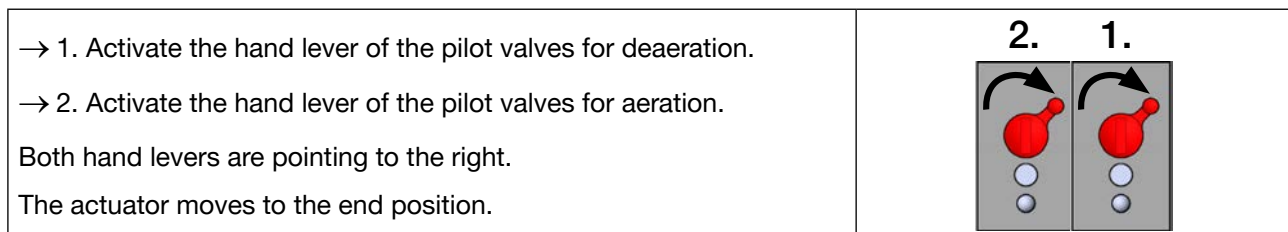
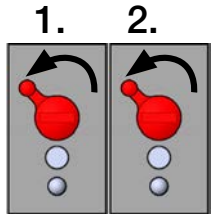


Figure 27: Move the actuator to the end position

Move the actuator back to the rest position

Turn the hand lever to the left with a screwdriver.

Please note: - Do not press the lever while turning it
- Follow the order described below

- | | |
|---|---|
| <p>→ 1. Activate the hand lever of the pilot valves for aeration.</p> <p>→ 2. Activate the hand lever of the pilot valves for deaeration.</p> <p>Both hand levers are pointing to the left (normal position).</p> <p>The actuator moves to the rest position by spring force.</p> |  |
|---|---|

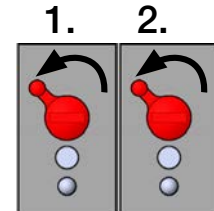


Figure 28: Move the actuator back to the rest position

12 ELECTRICAL INSTALLATION WITHOUT FIELDBUS COMMUNICATION

There are 2 connection variants for Type 8692, 8693:

- Multi-pole with circular plug-in connector
- Cable gland with connection terminals

Signal values

Operating voltage:	24 V DC
Set-point value (process/position controller):	0...20 mA; 4...20 mA 0...5 V; 0...10 V
Actual value (only process controller):	4...20 mA; frequency; Pt 100

12.1 Electrical installation with circular plug-in connector



DANGER

Risk of injury due to electric shock.

- ▶ Before reaching into the system, switch off the power supply and secure to prevent reactivation.
- ▶ Observe the applicable accident prevention regulations and safety regulations for electrical equipment.



WARNING

Risk of injury from improper installation.

- ▶ Installation may be carried out by authorized technicians only and with the appropriate tools.

Risk of injury from unintentional activation of the system and uncontrolled restart.

- ▶ Secure system against unintentional activation.
- ▶ Following installation, ensure a controlled restart.



Using the 4...20 mA set-point value input

If several devices of Type 8692, 8693 are connected in series and the power supply to a device in this series connection fails, the input of the failed device becomes highly resistive. As a result, the 4...20 mA standard signal fails. In this case please contact Bürkert Service directly.

Minimum temperature rating of the cable to be connected to the field wiring terminals: 75 °C

Procedure:

→ Connect Type 8692, 8693 according to the tables.

When the operating voltage is applied, Type 8692, 8693 is operating.

→ Now make the required basic settings and adjustments for the position controller/process controller.
The procedure is described in chapter „14 Start-up“.

Designation of the circular plug-in connectors:

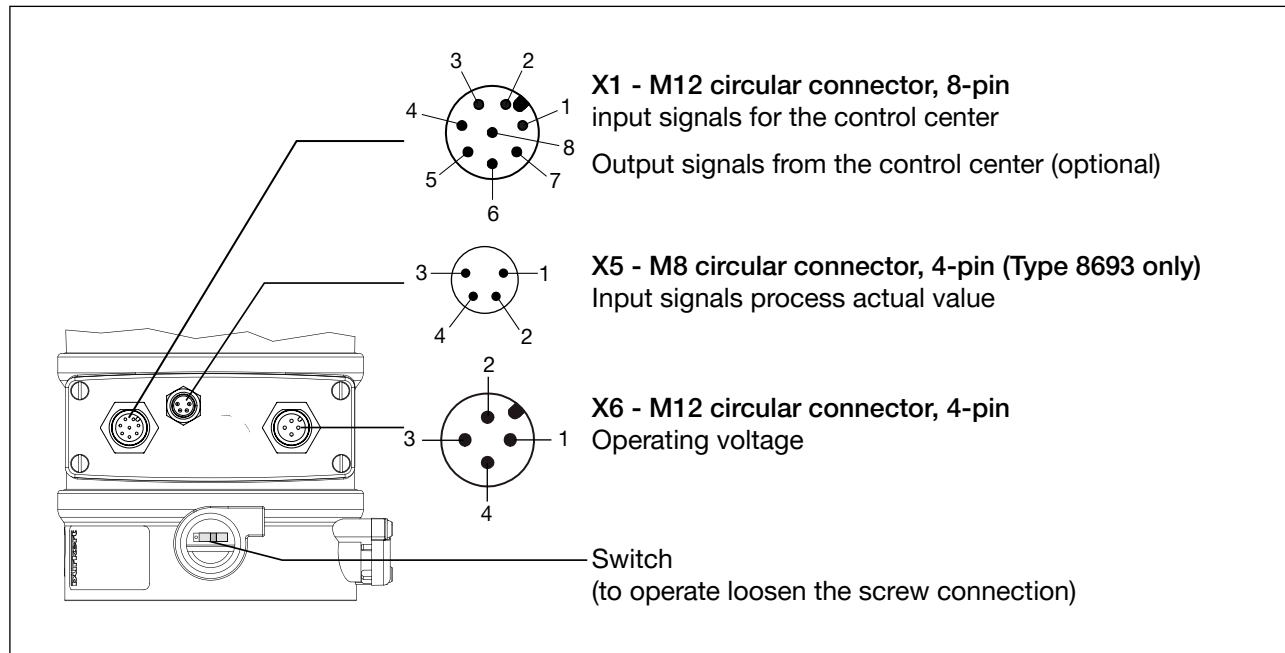


Figure 29: Electrical connection with 24 V DC circular plug-in connector

12.1.1 X1 - M12 circular connector, 8-pin

Pin	Wire color*	Assignment
Input signals from the control center (e.g. PLC)		
1	white	Digital input + <div style="display: inline-block; vertical-align: middle;"> $\left\{ \begin{array}{l} 0...5\text{ V} \quad (\text{logical } 0) \\ 10...30\text{ V} \quad (\text{logical } 1) \end{array} \right.$ </div>
7	blue	Set-point value GND
8	red	Set-point value + (0/4...20 mA or 0...5/10 V) galvanically isolated for the operating voltage

MAN 1000327408 EN Version: N Status: RL (released | freigegeben) printed: 01.09.2023

Pin	Wire color*	Assignment
Output signals to the control center (e.g. PLC) – (required for analog output and/or digital output option only)		
2	brown	Digital outputs GND
3	green	Digital output 2 (24 V / 0 V)
4	yellow	Digital output 1 (24 V / 0 V)
5	gray	Analog position feedback GND
6	pink	Analog position feedback + (0/4...20 mA or 0...5/10 V) galvanically isolated for the operating voltage
* The indicated wire colors refer to the connection cable, part no. 919061, available as an accessory.		

Table 9: X1 - M12 circular connector, 8-pin

12.1.2 X6 - M12 circular connector, 4-pin, operating voltage

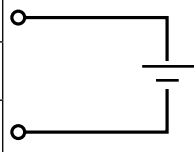
Pin	Wire color*	Assignment	On the device side	External circuit / signal level
1	brown	+24 V	1	 <p>24 V DC ± 10 % max. residual ripple 10 %</p>
2	Not used			
3	blue	GND	3	
4	Not used			
* The indicated wire colors refer to the connection cable, part no. 918038, available as an accessory.				

Table 10: X6 - M12 circular connector, 4-pin, operating voltage

12.1.3 X5 - M8 circular connector, 4-pin, input signals process actual value (for Type 8693 only)

Input type*	Pin	Assignment	Switch **	On the device side	External circuit
4...20 mA - internally supplied	1 2 3 4	+24 V transmitter power supply Output from transmitter GND (identical to GND operating voltage) Bridge after GND (GND from 3-conductor transmitter)	 Switch on left		
4...20 mA - externally supplied	1 2 3 4	Not used Process actual + Not used Process actual -	 Switch on right	2 4	4...20 mA GND 4...20 mA
Frequency - internally supplied	1 2 3 4	+24 V sensor power supply Clock input + Clock input - (GND) Not used	 Switch on left	1 2 3	+24 V Clock + Clock - / GND (identical to GND operating voltage)
Frequency - externally supplied	1 2 3 4	Not used Clock input + Clock input - Not used	 Switch on right	2 3	Clock + Clock -
Pt 100 (see information below)	1 2 3 4	Not used Pt 100 power supply Pt 100 GND Pt 100 compensation	 Switch on right	2 3 4	

* Adjustable via software (see chapter „15.2.1 PV-INPUT – Specifying signal type for the process actual value“).

** Position of the switch, see „Figure 29: Electrical connection with 24 V DC circular plug-in connector“.

Table 11: X5 - M8 circular connector, 4-pin, input signals process actual value (for Type 8693 only)



For reasons of wire resistance compensation, connect the Pt 100 sensor via 3 wires. Bridge pin 3 and pin 4 on the sensor.

MAN 1000327408 EN Version: N Status: RL (released | freigegeben) printed: 01.09.2023

12.1.4 Switch position (only type 8693)

For the “internally supplied” input type, the GND signal of the process actual value must be connected to the GND signal of the operating voltage. A bridge is established internally between both GND signals using the “left” switch position.

Supplied	Assignment	Switch position
Internally supplied	GND process actual value equal to GND operating voltage	Switch on left
Externally supplied	GND process actual value electrically isolated from GND operating voltage	Switch on right

Table 12: Switch position

12.2 Electrical installation with cable gland



DANGER

Risk of injury due to electric shock.

- ▶ Before reaching into the system, switch off the power supply and secure to prevent reactivation.
- ▶ Observe the applicable accident prevention regulations and safety regulations for electrical equipment.



WARNING

Risk of injury from improper installation.

- ▶ Installation may be carried out by authorized technicians only and using the appropriate tools.

Risk of injury from unintentional activation of the system and uncontrolled restart.

- ▶ Secure system against unintentional activation.
- ▶ Following installation, ensure a controlled restart.



Using the 4...20 mA set-point value input

If several devices of Type 8692, 8693 are connected in series and the power supply to a device in this series connection fails, the input of the failed device becomes highly resistive. As a result, the 4...20 mA standard signal fails. In this case please contact Bürkert Service directly.

Procedure:

- Loosen the 4 screws of the connection cover and remove the cover. The connection terminals are now accessible.
- Push the cables through the cable gland.
- Connect the wires. The terminal assignment can be found in the tables below.
- Tighten the union nut of the cable gland (tightening torque approx. 1.5 Nm (1.1 lbf ft)).
- Place the connection cover with inserted seal onto the electrical connection housing and tighten cross-wise (tightening torque max. 0.7 Nm (0.5 lbf ft)).

NOTE

Damage or malfunction due to ingress of dirt and moisture.

To comply with the degree of protection IP65/IP67:

- ▶ Close all unused cable glands with dummy plugs.
- ▶ Tighten the union nut on the cable gland. Tightening torque depends on cable size or dummy plug approx. 1.5 Nm.
- ▶ Only screw on connection cover with the seal inserted. Tightening torque max. 0.7 Nm.

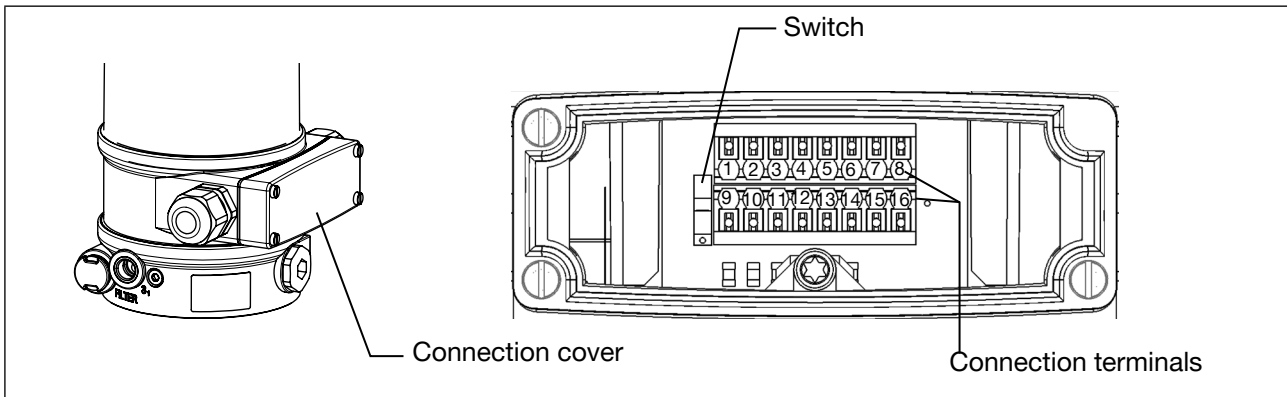


Figure 30: Cable gland connection

12.2.1 Terminal assignment: Input signals from the control center (e.g. PLC)

Terminal	Assignment	External circuit / signal level
6	Digital input +	+ $\begin{cases} 0...5 \text{ V} & (\text{logical } 0) \\ 10...30 \text{ V} & (\text{logical } 1) \end{cases}$
7	Set-point value GND	GND set-point value
8	Set-point value +	+ (0/4...20 mA or 0...5/10 V) galvanically isolated for the operating voltage
13	Not used	
14	Digital input GND	GND specific to operating voltage GND (terminal GND)

Table 13: Terminal assignment; input signals of the control center

12.2.2 Terminal assignment: Output signals to the control center (e.g. PLC) - (required for analog output and/or digital output option only)

Terminal	Assignment	External circuit / signal level
1	Analog position feedback GND	GND analog feedback
2	Analog position feedback +	+ (0/4...20 mA or 0...5/10 V) galvanically isolated for the operating voltage
3	Digital output GND	GND
4	Digital output 2	24 V / 0 V, NC / NO specific to operating voltage GND (terminal GND)
5	Digital output 1	24 V / 0 V, NC / NO specific to operating voltage GND (terminal GND)

Table 14: Terminal assignment; output signals to the control center

12.2.3 Terminal assignment: Process actual value input (for Type 8693 only)

Input type*	Terminal	Assignment	Switch **	On the device side	External circuit
4...20 mA - internally supplied	9	GND (identical to GND operating voltage)	Switch below		
	10	Bridge after GND (GND from 3-conductor transmitter)			
	11	Output from transmitter			
	12	+24 V transmitter power supply			
4...20 mA - externally supplied	9	Not used	Switch above		
	10	Process actual -		11	4...20 mA
	11	Process actual +		10	GND
	12	Not used			
Frequency - internally supplied	9	Clock input - (GND)	Switch below	12	+24 V
	10	Not used		11	Clock +
	11	Clock input +			
	12	+24 V sensor power supply		9	Clock - / GND (identical to GND operating voltage)
Frequency - externally supplied	9	Clock input -	Switch above		
	10	Not used		11	Clock +
	11	Clock input +			
	12	Not used		9	Clock -
Pt 100 *** (see note)	9	Pt 100 GND	Switch above		
	10	Pt 100 compensation			
	11	Pt 100 power supply			
	12	Not used			

* Adjustable via software (see chapter „15.2.1 PV-INPUT – Specifying signal type for the process actual value“).

** The switch is situated under the connection cover (see „Figure 30: Cable gland connection“).

Table 15: Terminal assignment; process actual value input (for Type 8693 only)



*** For reasons of wire resistance compensation, connect the Pt 100 sensor via 3 wires. Always bridge Terminal 9 and Terminal 10 on the sensor.

MAN 1000327408 EN Version: N Status: RL (released | freigegeben) printed: 01.09.2023

12.2.4 Terminal assignment: operating voltage

Terminal	Assignment	On the device side	External circuit / signal level
15	Operating voltage GND		24 V DC \pm 10 % max. residual ripple 10 %
16	Operating voltage +24V		

Table 16: Terminal assignment; operating voltage

12.2.5 Switch position (only Type 8693)

For the “internally supplied” input type, the GND signal of the process actual value must be connected to the GND signal of the operating voltage. A bridge is established internally between both GND signals using the “left” switch position.

Supplied	Assignment	Switch position
Internally supplied	GND process actual value equal to GND operating voltage	Switch on left
Externally supplied	GND process actual value electrically isolated from GND operating voltage	Switch on right

Table 17: Switch position

13 OPERATION

WARNING

Danger due to improper operation.

Improper operation may result in injuries as well as damage to the device and its environment.

- ▶ The operating personnel must know and have understood the contents of the operating instructions.
- ▶ Observe the safety instructions and intended use.
- ▶ Only adequately trained personnel may operate the equipment/the device.

There are different operating levels for the operation and setting of type 8692, 8693.

- **Process level:**

The running process is displayed and operated on the process level.

Operating state:	AUTOMATIC	– Displaying the process data
	MANUAL	– Manually opening and closing the valve

- **Setting level:**

The basic settings for the process are made on the setting level.

- Inputting the operating parameters
- Activating auxiliary functions



If the device is in the AUTOMATIC operating state when changing to the setting level, the process continues running during the setting.

13.1 Description of the operating and display elements

The device features 4 keys for operation and a 128 x 64 dot matrix graphics display as a display element.

The display is adjusted to the set functions and operating levels.

In principle, a distinction can be made between the display view for the process level and the setting level.

When the operating voltage has been applied, the process level is displayed.

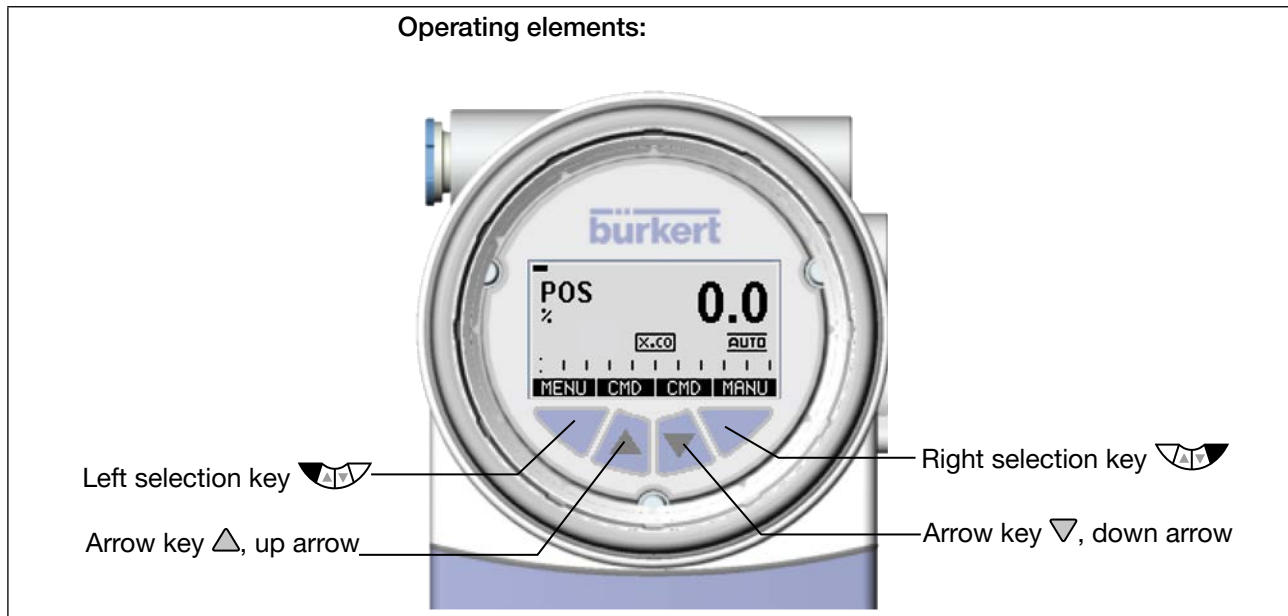


Figure 31: Operating elements

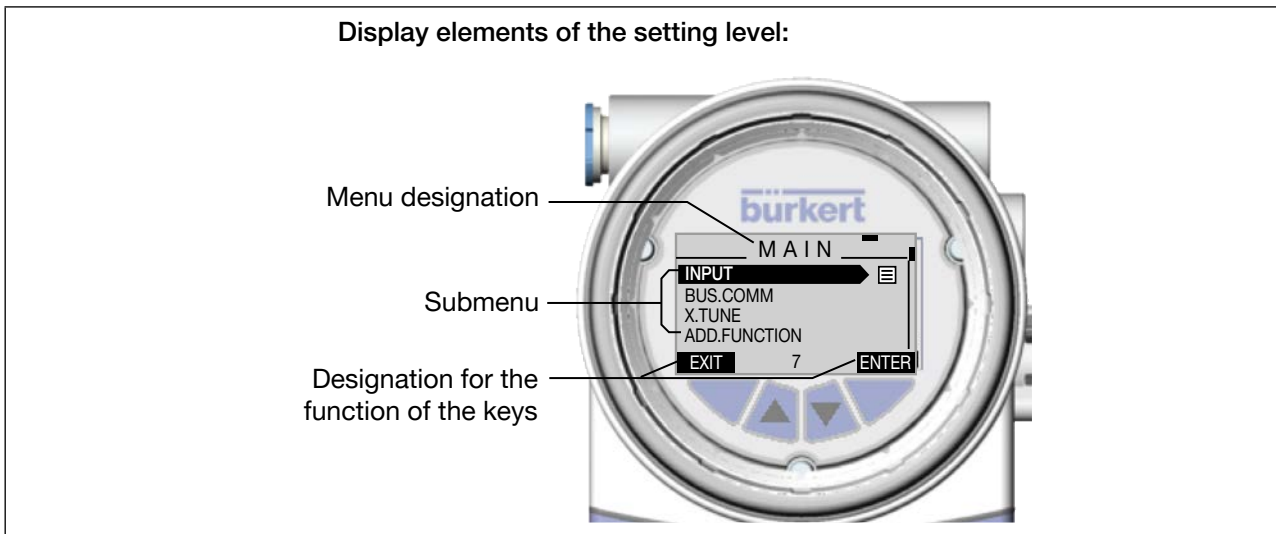


Figure 32: Display elements of the setting level

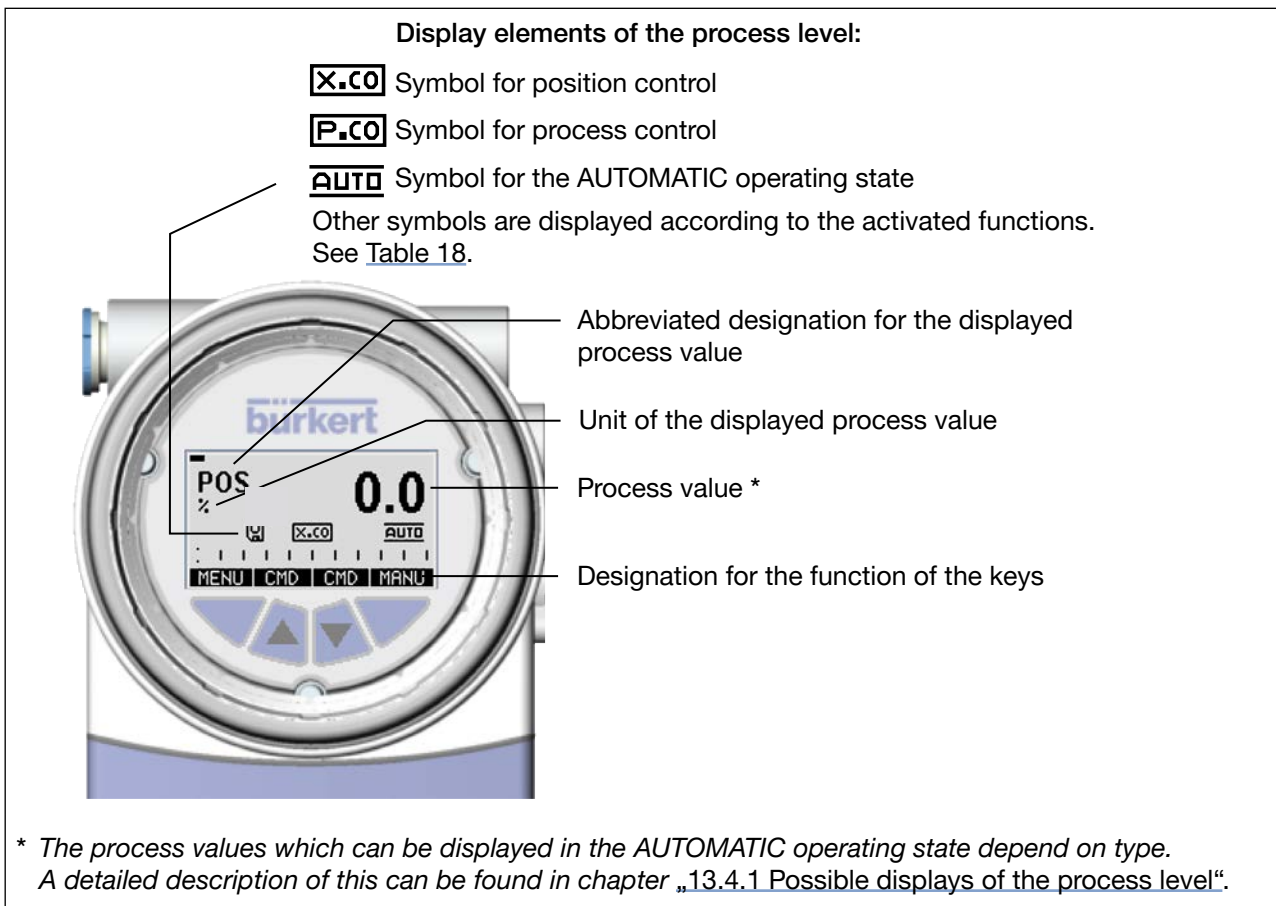


Figure 33: Display elements of the process level

MAN 1000327408 EN Version: N Status: RL (released | freigegeben) printed: 01.09.2023

13.1.1 Description of the symbols which are displayed on the process level

The symbols which are displayed depend on

- Type,
- Operation as position or process controller,
- AUTOMATIC or MANUAL operating state and
- The activated functions.

Operation	Icon	Description
Types 8692, 8693		AUTOMATIC operating state
Operation as position controller		Diagnostics active (optional; only available if the device has the additional software for the diagnostics)
		X.CONTROL / Position controller active (symbol is indicated for Type 8693 only)
		CUTOFF active
		SAFEPOS active
		Interface I/O RS232 HART
		SECURITY active
		Bus active
		SIMULATION active
Other symbols for Type 8693		P.CONTROL / process controller active
Operation as process controller		

Table 18: Symbols of the process level

13.2 LED for indicating device status

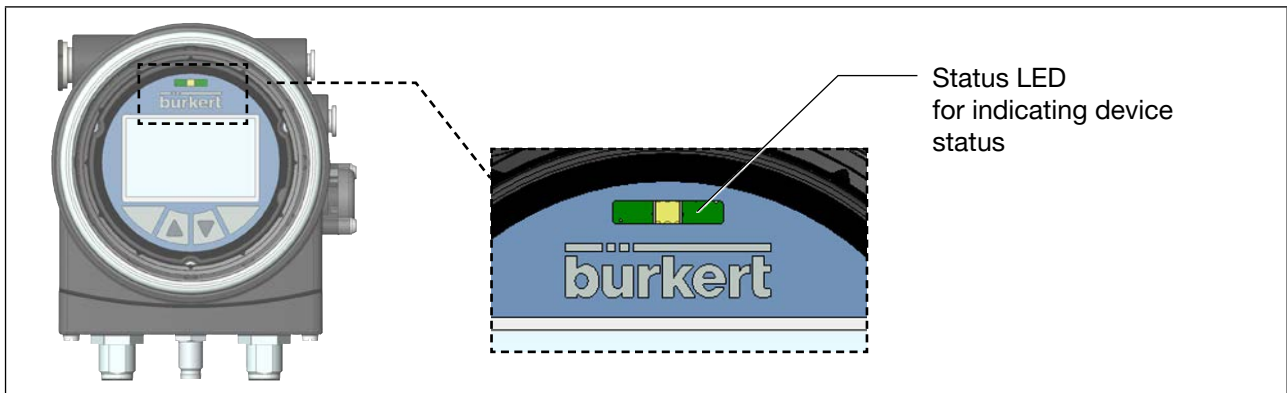


Figure 34: Status LED for indicating device status

The status LED lights up according to NAMUR NE 107, in the color specified for the device status.

If several device statuses exist simultaneously, the device status with the highest priority is displayed. The priority is determined by the severity of the deviation from standard operation (red = failure = highest priority).



The status LED can be deactivated and activated in the Bürkert Communicator software.

Setting: **General settings** → **Parameter** → **Status LED**

Factory setting: LED activated

Displays:

Status display in accordance with NE 107, edition 2006-06-12			
Color	Color code	Description	Meaning
red	5	Failure, error or fault	Due to a malfunction in the device or on its periphery, controlled operation is not possible
orange	4	Function check	The device is being worked on; controlled operation is therefore temporarily not possible.
yellow	3	Out of specification	The ambient conditions or process conditions for the device are outside the specified area. Device internal diagnostics point to problems in the device or with the process properties.
blue	2	Maintenance required	The device is in controlled operation, however function is briefly restricted. → Maintain device.
green	1	Normal	Device is operating faultlessly. Status changes are shown in color. Messages are transmitted via any connected fieldbus.

Table 19: Indication of the device status according to NAMUR NE 107

13.3 Function of the keys

The function of the 4 keys for operation differs depending on the operating state (AUTOMATIC or MANUAL) and operating level (process level or setting level).



The description of the operating levels and operating states can be found in chapter and „13 Operation“ and „13.7 Operating states“.

Key function on the process level:			
Key	Key function	Description of the function	Operating state
Arrow key ▲	OPN	Manual opening of the actuator.	MANUAL
		Change the displayed value (e.g. POS-CMD-TEMP-...).	AUTOMATIC
Arrow key ▼	CLS	Manual closing of the actuator.	MANUAL
		Change the displayed value (e.g. POS-CMD-TEMP-...).	AUTOMATIC
left selection key 	MENU	Change to the setting level. Note: Press key for approx. 3 s.	AUTOMATIC or MANUAL
right selection key 	AUTO	Return to AUTOMATIC operating state.	MANUAL
	MANU	Change to MANUAL operating state.	AUTOMATIC

Key function on the setting level:			
Key	Key function	Description of the function	
Arrow key ▲		Scroll up in the menus.	
	+	Increase numerical values.	
Arrow key ▼		Scroll down in the menus.	
	-	Decrease numerical values.	
	<-	Change by one digit to the left; when entering numerical values.	
left selection key 	EXIT	Return to the process level.	
		Gradually return from a submenu option.	
	ESC	Leave a menu.	
	STOP	Stop a sequence.	
right selection key 	ENTER	Select, activate or deactivate a menu option.	
	SELEC OK INPUT		
	EXIT	Gradually return from a submenu option.	
	RUN	Start a sequence.	
	STOP	Stop a sequence.	

Table 20: Function of the keys

13.3.1 Entering and changing numerical values

Changing numerical values with fixed decimal places:

Key	Key function	Description of the function	Example
Arrow key ▽	<-	Change to the next decimal place (from right to left). After reaching the last decimal place, the display switches back to the first decimal place.	Enter date and time.
Arrow key △	+	Increase value. When the largest possible value has been reached, 0 is displayed again.	
left selection key 	ESC or EXIT	Return without change.	
right selection key 	OK	Accept the set value.	

Table 21: Change numerical values with fixed decimal places.

Enter numerical values with variable decimal places:

Key	Key function	Description of the function	Example
Arrow key △	+	Increase value.	Enter PWM signal
Arrow key ▽	-	Reduce value.	
left selection key 	ESC or EXIT	Return without change.	
right selection key 	OK	Accept the set value.	

Table 22: Enter numerical values with variable decimal places.

13.4 Adjusting the display

The display can be individually adjusted for the operation and monitoring of the process.

- To do this, menu options can be activated for displaying the process level. *POS* and *CMD* are activated in the as-delivered state.
- The menu options which can be displayed depend on the type.



How you can adjust the display for Type 8692 individually to the process to be controlled is described in chapter „16.2.1 EXTRAS – Setting the display“.

13.4.1 Possible displays of the process level

→ ▲ / ▼ select possible displays in AUTOMATIC operating state.

	<p>Actual position of the valve actuator (0100 %)</p>
	<ul style="list-style-type: none"> • Set-point position of the valve actuator or • Set-point position of the valve actuator after rescaling by possibly activated split range function or correction characteristic (0100 %)
	<p>Temperature (°C) of the electronics</p>
	<p>Process actual value</p>
	<p>Process set-point value</p> <p>Right selection key :</p> <p>The key function depends on the set-point value default (menu: P.CONTROL → P.SETUP → SP-INPUT → internal/external).</p>
	<p>INPUT Set-point value default = internal</p>
	<p>MANU Set-point value default = external</p>
	<p>Only for type 8693</p>
	<p>Graphical display of <i>SP</i> and <i>PV</i> with time axis</p>
	<p>Only for type 8693</p>


	<p>Graphical display of <i>POS</i> and <i>CMD</i> with time axis</p>
	<p>Time, weekday and date</p>
	<p>Input signal for set-point position (0...5/10 V or 0/4...20 mA) Only for operation as position controller X.CO</p>
	<p>Automatic adjustment of the position controller</p>
	<p>Automatic optimization of the process controller parameters Only for type 8693</p>
	<p>Automatic linearization of the process characteristics Only for type 8693</p>
	<p>Simultaneous display of the set-point position and the actual position of the valve actuator (0...100 %)</p>
	<p>Simultaneous display of the set-point position and the actual position of the valve actuator (0...100 %) Only for type 8693</p>

Table 23: Displays of the process level

MAN 1000327408 EN Version: N Status: RL (released | freigegeben) printed: 01.09.2023

13.5 Switching between the operating levels

Switch to the setting level as follows:


→  Select **MENU** and press for 3 seconds.

✔ You are on the setting level.

Switch to the process level as follows:

→  Select **EXIT**.

✔ You are on the process level.

 The set MANUAL or AUTOMATIC operating state is retained even when the operating level is changed.

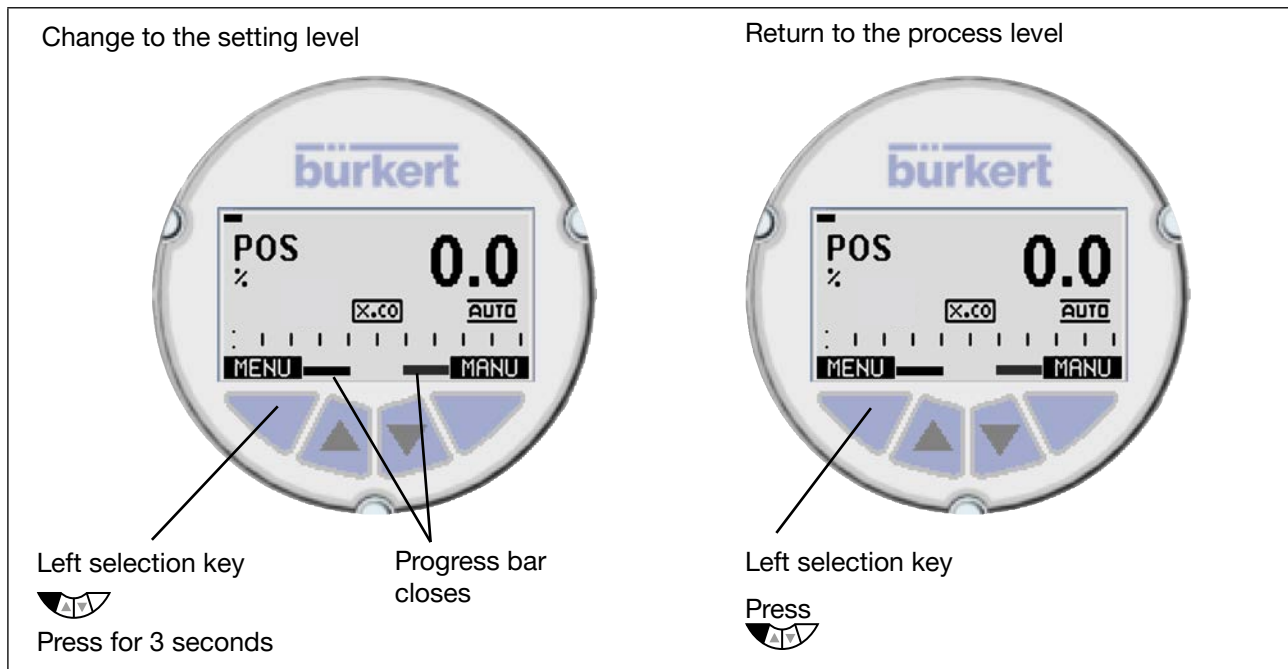


Figure 35: Switch operating level











13.6 Date and time

Date and time are set on the process level in the *CLOCK* menu.

To ensure that the menu for *CLOCK* can be selected on the process level, the following functions must be activated in two stages:

1. The *EXTRAS* auxiliary function in the *ADD.FUNCTION* menu
2. The *CLOCK* function in the *EXTRAS* auxiliary function, *DISP.ITEMS* submenu.

Activate *EXTRAS* and *CLOCK* as follows:



-  Press **MENU** for 3 s. Switching from process level ⇒ setting level.
 - ▲ / ▼ Select *ADD.FUNCTION*.
 -  Select **ENTER**. The possible auxiliary functions are displayed.
 - ▲ / ▼ Select *EXTRAS*.
 -  Select **ENTER**.
Activate the *EXTRAS* auxiliary function by marking with a cross ☒ and transfer into the main menu (MAIN).
 -  Select **EXIT**. Return to the main menu (MAIN).
 - ▲ / ▼ Select *EXTRAS*.
 -  Select **ENTER**. The submenus of *EXTRAS* are displayed.
 - ▲ / ▼ *DISP.* Select *ITEMS*.
 -  Select **ENTER**. The possible menu options are displayed.
 - ▲ / ▼ Select *CLOCK*.
 -  Select **SELECT**. The activated *CLOCK* function is now marked by a cross ☒.
 -  Select **EXIT**. Return to the *EXTRAS* menu.
 -  Select **EXIT**. Return to the main menu (MAIN).
 -  Select **EXIT**. Switching from setting level ⇒ process level.
- ✔ You have activated *EXTRAS* and *CLOCK*.



Date and time must be reset whenever the device is restarted.
After a restart the device therefore switches immediately and automatically to the corresponding menu.









13.6.1 Setting date and time

Activate the input screen as follows:

- On the process level select   the display for *CLOCK* using the arrow keys.
- Press **INPUT** to open the input screen for the setting.
- Set date and time as described in the following table.

 You have activated the input screen.

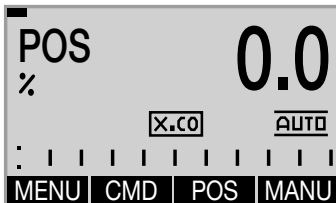
Set the date and time as follows:

-  Select **<-**.
Switch to the next time unit (from right to left).
When the last time unit for the date has been reached, the display switches to the time units for the time.
If the last unit is at top left (hours), the display switches back to the first unit at bottom right (year).
 -  Select **+**.
Increase value.
When the largest possible value has been reached, 0 is displayed again.
 -  Select **ESC**. Return without change.
 -  Select **OK**. Accept the set value.
 -  Select *EXTRAS*.
 -  Select **ENTER**. The submenus of *EXTRAS* are displayed.
 -  Switching the display.
-  You have set date and time.

13.7 Operating states

Type 8692, 8693 has 2 operating states: AUTOMATIC and MANUAL.

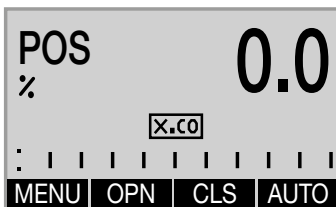
When the operating voltage is switched on, the device is in the AUTOMATIC operating state.



AUTOMATIC

In the AUTOMATIC operating state normal controlled operation is implemented.

(The symbol for AUTOMATIC **AUTO** is shown on the display. A bar runs along the upper edge of the display).



MANUAL

In the MANUAL operating state the valve can be manually opened or closed using the arrow keys \triangle ∇ (key function **OPN** and **CLS**).

(The symbol for AUTOMATIC **AUTO** is hidden. No bar running along the upper edge of the display).



The MANUAL operating state (key function **MANU**) is for the following process value displays only:

POS, CMD, PV, CMD/POS, SP/PV.

For SP only for external process set-point value.

13.7.1 Changing the operating state

Switch to the MANUAL operating state as follows:

→  Select **MANU**.

- ✓ You are in the MANUAL operating state.
Only available for process value display: POS, CMD, PV, SP

Switch to the AUTOMATIC operating state as follows:

→  Select **AUTO**.

- ✓ You are in the AUTO operating state.

13.8 Activating and deactivating auxiliary functions

Auxiliary functions can be activated for demanding control tasks.



The auxiliary functions are activated via the *ADD.FUNCTION* basic function and transferred to the main menu (MAIN).

The auxiliary function can then be selected and set in the extended main menu (MAIN).

13.8.1 Activating auxiliary functions

Activate the auxiliary functions as follows:

→ Press **MENU** for 3 s. Switching from process level ⇒ setting level.

→ Select *ADD.FUNCTION*.

→ Select **ENTER**. The possible auxiliary functions are displayed.

→ Select *auxiliary function*.

→ Select **ENTER**. The selected auxiliary function is now marked by a cross ☒.

→ Select **EXIT**.

Acknowledgment and simultaneous return to the main menu (MAIN).

✔ You have activated the marked function and included it in the main menu.

Set the parameters as follows:

→ Select *auxiliary function*. In the main menu (MAIN) select the auxiliary function.

→ Select **ENTER**. Opening the submenu to input the parameters.

The setting of the submenu is described in the respective chapter of the auxiliary function.

✔ You have set the parameters.

Return from the submenu and switch the process level as follows:

→ Select **EXIT*** or **ESC***. Return to a higher level or to the main menu (MAIN).

→ Select **EXIT**. Switching from setting level ⇒ process level.

✔ You have changed the process level.


* The designation of the key depends on the selected auxiliary function.


13.8.2 Deactivating auxiliary functions

Deactivate the auxiliary functions as follows:

→  Press **MENU** for 3 s. Switching from process level \Rightarrow setting level.

→  Select **ADD.FUNCTION**.


→  Select **ENTER**. The possible auxiliary functions are displayed.

→  Select *auxiliary function*.

→  Select **ENTER**. Remove function mark (no cross)

→  Select **EXIT**.

Acknowledgment and simultaneous return to the main menu (MAIN).

 You have deactivated the marked function and removed it from the main menu.



Deactivation removes the auxiliary function from the main menu (MAIN). This will cause the previous settings, created under this function, to be rendered invalid.

13.9 Manually opening and closing the valve

In the MANUAL operating state, the valve can be opened and closed manually \blacktriangle \blacktriangledown using the arrow keys.



The MANUAL operating state (key function **MANU**) applies to the following process value displays:

- *POS*, actual position of the valve actuator.
- *CMD*, set-point position of the valve actuator.
When switching to MANUAL operating state *POS* is displayed.
- *PV*, process actual value.
- *SP*, process set-point value.
When switching to MANUAL operating state, *PV* is displayed. The switch is possible only for external set-point value default (menu: *P.CONTROL* → *P.SETUP* → *SP-INPUT* → *external*).
- *CMD/POS*, set-point position of the valve actuator.
When switching to MANUAL operating state *POS* is displayed.
- *SP/PV*, process set-point value.
When switching to MANUAL operating state, *PV* is displayed. The switch is possible only for external set-point value default (menu: *P.CONTROL* → *P.SETUP* → *SP-INPUT* → *external*).

Manually open and close as follows:

→ \blacktriangle / \blacktriangledown Select *POS*, *CMD*, *PV* or *SP*.

→  Select **MANU**. Change to MANUAL operating state.

→ Select \blacktriangle . Aerating the actuator

Control function A (SFA):	Valve opens
Control function B (SFB):	Valve closes
Control function I (SFI):	Connection 2.1 aerated

→ Select \blacktriangledown . Deaerating the actuator

Control function A (CFA):	Valve closes
Control function B (CFB):	Valve opens
Control function I (CFI):	Connection 2.2 aerated

✔ You have manually opened and closed the valve.



CFA:	Actuator spring force closing
CFB:	Actuator spring force opening
CFI:	Actuator double-acting

14 START-UP



Before start-up, carry out pneumatic, fluid and electrical installation of Type 8692, 8693 and of the valve. For a description see chapters 11 and 12.

When the operating voltage is applied, Type 8692, 8693 is operating and is in the AUTOMATIC operating state. The display shows the process level with the values for *POS* and *CMD*.

The following basic settings must be made for starting up the device:

Device type	Sequence	Type of basic setting	Setting via	Description in chapter	Requirement
8692 and 8693	1	Basic setting of the device: Set input signal (standard signal).	<i>INPUT</i>	14.2	essential
	2	Adjust device to the local conditions.	<i>X.TUNE</i>	14.3	
only 8693 (Process controller)	3	Activate process controller.	<i>ADD.FUNCTION</i>	14.4	essential
	4	Basic setting of the process controller: – Setting the hardware	<i>P.CONTROL</i>	15	
			→ <i>SETUP</i>	15.2	
	5	– Parameter setting of the software.	→ <i>PID. PARAMETER</i>	15.3	
	6	Automatic linearization of the process characteristics.	<i>P.Q'LIN</i>	15.4	to be performed optionally
7	Automatic parameter setting for the process controller.	<i>P.TUNE</i>	15.5		

Table 24: Start-up sequence

The basic settings are made on the setting level.

To switch from the process level to the setting level, press the **MENU** key for approx. 3 seconds.

Then the main menu (MAIN) of the setting level is indicated on the display.



WARNING



Risk of injury from improper operation.

Improper operation may result in injuries as well as damage to the device and the area around it

- ▶ Before start-up, ensure that the operating personnel are familiar with and completely understand the contents of the operating instructions.
- ▶ Observe the safety instructions and intended use.
- ▶ Only adequately trained personnel may start up the equipment/the device.

14.1 Basic setting of the device








The following settings must be made for the basic setting of Type 8692, 8693:

1.  Selection of the input signal (see chapter [14.2](#)).
2.  Automatic self-parameterization of the position controller (see chapter [14.3](#)).

14.2 INPUT - Setting the input signal

This setting is used to select the input signal for the set-point value.

Set the input signal as follows:

-  Press **MENU** for 3 s. Switching from process level ⇒ setting level.
 -  Select **INPUT**.
 -  Select **ENTER**. The possible input signals for **INPUT** are displayed.
 -  Select input signal (*4...20 mA, 0...20 mA, ...*).
 -  Select **SELECT**. The selected input signal is now marked by a filled circle ●.
 -  Select **EXIT**.
Return to the main menu (MAIN).
 -  Select **EXIT**. Switching from setting level ⇒ process level.
- ✔ You have set the input signal.

14.3 X.TUNE – Automatic adjustment of the position controller

WARNING

Danger due to the valve position changing when the *X.TUNE* function is run.

When the *X.TUNE* function is run under operating pressure, there is an acute risk of injury.

- ▶ Never run *X.TUNE* while the process is running.
- ▶ Secure system against unintentional activation.

NOTE

An incorrect supply pressure or incorrectly connected operating medium pressure may cause the controller to be wrongly adjusted.

- ▶ Run *X.TUNE* in each case at the supply pressure available in subsequent operation (= pneumatic auxiliary power).
- ▶ To exclude interference due to flow forces, run the *X.TUNE* function preferably **without** operating medium pressure.


The following functions are actuated automatically:

- Adjustment of the sensor signal to the (physical) stroke of the actuator used.
- Determination of parameters of the PWM signals to control the solenoid valves integrated in type 8692, 8693.
- Adjustment of the controller parameters for the position controller. Optimization occurs according to the criteria of the shortest possible transient time without overshoots.


Automatically adjust the position controller as follows:

→  Press **MENU** for 3 s. Switching from process level ⇒ setting level.

→  Select *X.TUNE*.

→  Hold down **RUN** as long as countdown (5 ...) is running.
 During the automatic adjustment messages are displayed indicating the progress of the *X.TUNE* (e.g. “*TUNE* #1...”).
 When the automatic adjustment ends, the message “*X.TUNE READY*” is indicated.

→ Press any key. Return to the main menu (MAIN).

→  Select **EXIT**. Switching from setting level ⇒ process level.

✔ You have automatically adjusted the position controller.



To stop *X.TUNE*, press the left or right selection key **STOP**.

Automatically determining dead band *DBND* by running *X.TUNE*:



When *X.TUNE* is running, the dead band can be automatically determined depending on the friction behavior of the actuating drive.
Before running *X.TUNE*, the *X.CONTROL* auxiliary function must be activated by incorporating it into the main menu (MAIN).
If *X.CONTROL* is not activated, a fixed dead band of 1 % is used.



The changed data is saved in the memory (EEPROM) only when there is a switch to the process level, by leaving the main menu (MAIN) using the left selection key **EXIT**.

Possible fault messages when running *X.TUNE*:

Display	Causes of fault	Corrective action
<i>TUNE</i> <i>err/break</i>	Manual termination of self-optimization by pressing the EXIT key.	
<i>X.TUNE</i> locked	The <i>X.TUNE</i> function is blocked.	Enter access code.
<i>X.TUNE</i> <i>ERROR 1</i>	No compressed air connected.	Connect compressed air.
<i>X.TUNE</i> <i>ERROR 2</i>	Compressed air failure while running <i>X.TUNE</i> .	Check compressed air supply.
<i>X.TUNE</i> <i>ERROR 3</i>	Actuator or control system deaeration side leaking.	Not possible, device defective.
<i>X.TUNE</i> <i>ERROR 4</i>	Control system aeration side leaking.	Not possible, device defective.
<i>X.TUNE</i> <i>ERROR 6</i>	The end positions for <i>POS-MIN</i> and <i>POS-MAX</i> are too close together.	Check compressed air supply.
<i>X.TUNE</i> <i>ERROR 7</i>	Incorrect assignment <i>POS-MIN</i> and <i>POS-MAX</i> .	To determine <i>POS-MIN</i> and <i>POS-MAX</i> , move the actuator in the direction indicated on the display.

Table 25: *X.TUNE*; possible fault messages

After making the settings described in chapters [14.2](#) and [14.3](#), the position controller is ready for use. Activation and configuration of auxiliary functions are described in the following chapter „[16 Auxiliary functions](#)“.

14.3.1 *X.TUNE.CONFIG* – Manual configuration of *X.TUNE*



This function is needed for special requirements only.
For standard applications the *X.TUNE* function (automatic adjustment of the position controller), as described above, is run using the factory default settings.





The description of the *X.TUNE.CONFIG* function can be found in chapter „[16.3 Manual configuration of *X.TUNE*](#)“.

14.4 Activation of the process controller

The process controller is activated by selecting the *P.CONTROL* auxiliary function in the *ADD.FUNCTION* menu.

The activation transfers *P.CONTROL* into the main menu (MAIN) where it is available for further settings.

Activate the process controller as follows:

-  Press **MENU** for 3 s. Switching from process level ⇒ setting level.
 - ▲ / ▼ Select *ADD.FUNCTION*.
 -  Select **ENTER**. The possible auxiliary functions are displayed.
 - ▲ / ▼ Select *P.CONTROL*.
 -  Select **ENTER**. *P.CONTROL* is now marked by a cross ☒.
 -  Select **EXIT**. Acknowledgment and simultaneous return to the main menu (MAIN).
P.CONTROL is now activated and incorporated into the main menu.
- ✔ You have activated the process controller.



Following activation of *P.CONTROL*, the *P.Q'LIN* and *P.TUNE* menus are also available in the main menu (MAIN). They offer support for the setting of the process control.

<i>P.Q'LIN</i>	Linearization of the process characteristic Description see chapter 15.4
<i>P.TUNE</i>	Self-optimization of the process controller (process tune) Description see chapter 15.5

ADD.FUNCTION – Add auxiliary functions







Apart from activating the process controller, *ADD.FUNCTION* can be used to activate auxiliary functions and incorporate them into the main menu.

The description can be found in chapter „[16 Auxiliary functions](#)“.









15 BASIC SETTING OF THE PROCESS CONTROLLER

15.1 *P.CONTROL* – Setting up and parameterization of the process controller

Set up the process controller as follows:

-  Press **MENU** for 3 s. Switching from process level \Rightarrow setting level.
-  Select *P.CONTROL*. Selection in the main menu (MAIN).
-  Select **ENTER**. The submenu options for the basic setting are displayed.
-  Select *SETUP*.
-  Select **ENTER**. The menu for setting up the process controller is displayed. Setup is described in chapter „15.2 [SETUP – Setting up the process controller](#)“.
-  Select **EXIT**. Return to *P.CONTROL*.
- ✔ You have set up the process controller.

Parameterize the process controller as follows:

-  Press **MENU** for 3 s. Switching from process level \Rightarrow setting level.
-  Select *P.CONTROL*. Selection in the main menu (MAIN).
-  Select **ENTER**. The submenu options for the basic setting are displayed.
-  Select *PID.PARAMETER*.
-  Select **ENTER**. The menu for parameterizing the process controller is displayed. Parameterization is described in chapter „15.3 [PID.PARAMETER – Parameterizing the process controller](#)“.
-  Select **EXIT**. Return to *P.CONTROL*.
-  Select **EXIT**. Return to the main menu (MAIN).
-  Select **EXIT**. Switching from setting level \Rightarrow process level.
- ✔ You have parameterized the process controller.

15.2 SETUP – Setting up the process controller

These functions specify the type of control.

The procedure is described in the following chapters [15.2.1](#) to [15.2.5](#).

15.2.1 PV-INPUT – Specifying signal type for the process actual value

One of the following signal types can be selected for the process actual value:

- | | | |
|-----------------------|---------------|---|
| • Standard signal | 4...20 mA | flow rate, pressure, level, temperature |
| • Frequency signal | 0...1000 Hz | flow rate |
| • Circuit with Pt 100 | -20...+220 °C | temperature |
| • Bus* | | flow rate, pressure, level, temperature |

Factory setting: 4...20 mA

Specify the signal type *PV-INPUT* in the *SETUP* menu:

→ ▲ / ▼ Select *PV-INPUT*.

→  Select **ENTER**. The signal types are displayed.

→ ▲ / ▼ Select signal type.

→  Select **SELECT**. The selected signal type is now marked by a filled circle ●.

→  Select **EXIT**. Return to *SETUP*.

✔ You have specified the signal type.

* Only for devices with bus interface

15.2.2 PV-SCALE– Scaling of the process actual value

The following settings are specified in the submenu of *PV-SCALE*:

- | | |
|--------------|---|
| <i>PVmin</i> | <ol style="list-style-type: none"> 1. The physical unit of the process actual value. 2. Position of the decimal point of the process actual value. 3. Lower scaling value of the process actual value. |
|--------------|---|



In *PVmin* the unit of the process actual value and the position of the decimal point are specified for all scaling values (*SPmin*, *SPmax*, *PVmin*, *PVmax*).

- | | |
|--------------|--|
| <i>PVmax</i> | Upper scaling value of the process actual value. |
|--------------|--|

- | | |
|-----------------|--|
| <i>K factor</i> | <p>K factor for the flow sensor</p> <p>The menu option is available only for the frequency signal type (<i>PV-INPUT</i> → <i>Frequency</i>).</p> |
|-----------------|--|

15.2.2.1. Effects and dependencies of the settings of PV-INPUT on PV-SCALE

The settings in the PV-SCALE menu have different effects, depending on the signal type selected in PV-INPUT.



Even the selection options for the units of the process actual value (in PVmin) depend on the signal type selected in PV-INPUT.

See following Table 26

Settings in the submenu of PV-SCALE	Description of the effect	Dependency on the signal type selected in PV-INPUT			
		4...20 mA	PT 100	Frequency	Bus
PVmin	Selectable unit of the process actual value for the physical variables.	Flow rate, temperature, pressure, length, volume. (as well as ratio as % and no unit)	Temperature	Flow-rate	Flow rate, temperature, pressure, length, volume. (as well as ratio as % and no unit)
	Adjustment range:	-9999...9999	-200...is specified by the sensor	0...9999	-9999...9999
PVmin PVmax	Specification of the reference range for the dead band of the process controller (P.CONTROL → PID. PARAMETER → DBND).	Yes	Yes	-	Yes
	Specification of the reference range for the analog feedback (option). See chapter „16.1.16.1. OUT ANALOG - Configuration of the analog output“	Yes	Yes	Yes	Yes
	Sensor calibration:	Yes see Figure 36	No	No	Yes see Figure 36
K factor	Sensor calibration:	No	No	Yes see Figure 37	No
	Adjustment range:	-	-	0...9999	-

Table 26: Effects of the settings in PV-SCALE depending on the signal type selected in PV-INPUT

Example of a sensor calibration for signal type 4...20 mA:

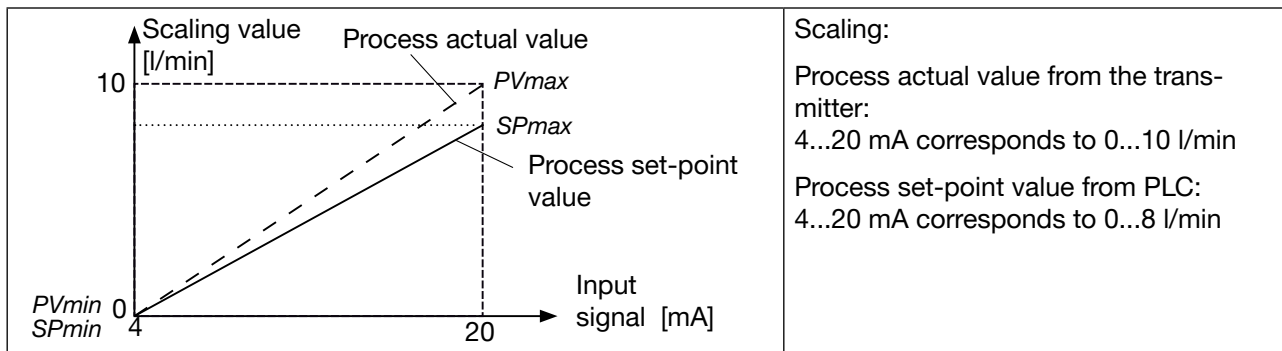


Figure 36: Example of a sensor calibration for signal type 4...20 mA



For internal set-point value default ($SP-INPUT \rightarrow internal$), the process set-point value is input directly on the process level.

Example of a sensor calibration for frequency signal type:

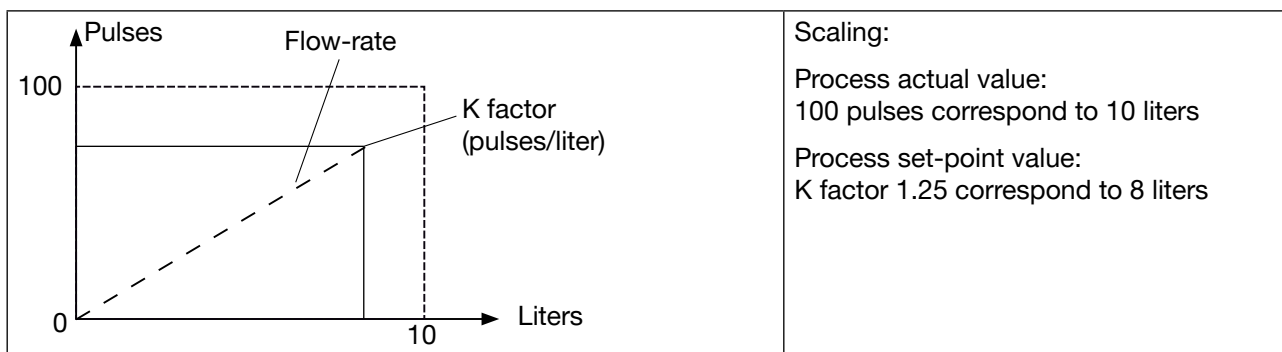




Figure 37: Example of a sensor calibration for frequency signal type

Scale the process actual value in the menu as follows:

- ▲ / ▼ Select **PV-SCALE**. Selection in the main menu (MAIN).
-  Select **ENTER**. The submenu options for scaling of the process actual value are displayed.
- ✔ You have scaled the process actual value.

PVmin is set as follows:


- ▲ / ▼ Select PVmin.
-  Select **INPUT**. The input screen is opened.
First specify the physical unit which has a dark background.
- ▲ Select **+**. Select physical unit.
- ▼ **<-** Select decimal point. The decimal point has a dark background.
- ▲ Select **+**. The last digit of the scaling value has a dark background.
- ▼ **<-** Select scaling value. The last digit of the scaling value has a dark background.
- ▲ / ▼ **+** Increase value and **<-** select decimal point.
Set scaling value (lower process actual value).

→  Select **OK** . Return to *PV-SCALE*.

✔ You have set the PVmin.

PVmax is set as follows:

→ ▲ / ▼ Select PVmax.

→  Select **INPUT**. The input screen is opened.
The last digit of the scaling value has a dark background.


→ ▲ / ▼ **+** Increase value and **<-** select decimal point.
Set scaling value (lower process actual value).

→  Select **OK** . Return to *PV-SCALE*.

✔ You have set the PVmax.

Set the K factor as follows:

→ ▲ / ▼ Select K factor.

→  Select **ENTER**. The submenu options for scaling of the process actual value are displayed.

EITHER

→ ▲ / ▼ Select **VALUE**. **Manual input of the K factor.**

→  Select **INPUT**. The input screen is opened. The decimal point has a dark background.

→ ▲ Select **+** . Specify position of the decimal point.

→ ▼ **<-** Select value. The last digit of the value has a dark background.

→ ▲ / ▼ **+** Increase value and **<-** select decimal point.
Set K factor.

→  Select **OK** . Return to *K-factor*.


OR

→ ▲ / ▼ Select **TEACH-IN**. **Calculating the K factor by measuring a specific flow rate.**

→  Select **INPUT**. The input screen is opened. The decimal point has a dark background.

→  Select **ENTER**, hold down for 5 s. Valve closes.

→  Select **START**. The container is being filled.

→  Select **STOP**. The measured volume is displayed and the input screen is opened.
The decimal point has a dark background.




→ ▲ Select **+** decimal point. Specify position of the decimal point.

→ ▼ **<-** Select value. The last digit of the value has a dark background.

→ ▲ Select **+** . The last digit of the scaling value has a dark background.

→ ▲ / ▼ **+** Increase value and **<-** select decimal point.
Set the measured volume.

→  Select **OK** . Return to *TEACH-IN*.

-  Select **EXIT**. Return to *K-factor*.
-  Select **EXIT**. Return to *PV-SCALE*.
-  Select **EXIT**. Return to *SETUP*.
- ✔ You have set the K factor.









If the submenu is left by pressing the left selection key **ESC**, the value remains unchanged.

15.2.3 *SP-INPUT* – Type of the set-point value default (internal or external)

The *SP-INPUT* menu specifies how the default of the process set-point value is to be implemented.

- Internal: Input of the set-point value on the process level
- External: Default of the set-point value via the standard signal input

Set the type of set-point value default as follows:

-  Select *SP-INPUT*
-  Select **ENTER**. The types of set-point value default are displayed.
-  Select the type of set-point value default.
-  Select **SELECT**. The selection is marked by a filled circle .
-  Select **EXIT**. Return to *SETUP*.
- ✔ You have set the type of set-point value default.



For internal set-point value default (*SP-INPUT* → *internal*), the process set-point value is input directly on the process level.

15.2.4 *SP-SCALE* – Scaling of the process set-point value (for external set-point value default only)

The *SP-SCALE* menu assigns the values for the lower and upper process set-point value to the particular current or voltage value of the standard signal.







The menu is available for external set-point value default only (*SP-INPUT* → *external*).



For internal set-point value default (*SP-INPUT* → *internal*), there is no scaling of the process set-point value via *SPmin* and *SPmax*.

The set-point value is input directly on the process level. The physical unit and the position of the decimal point are specified during the scaling of the process actual value (*PV-SCALE* → *PVmin*). Description see chapter „15.2.2 *PV-SCALE*– Scaling of the process actual value“.

Scaling the process set-point value:

- ▲ / ▼ Select *SP-SCALE*
-  Select **ENTER**. The submenu options for scaling of the process set-point value are displayed.
- ▲ / ▼ Select *SPmin*.
-  Select **INPUT**. The input screen is opened.
- ▲ / ▼ **+** Increase value and select **<-** decimal point.
Set scaling value (lower process set-point value). The value is assigned to the smallest current or voltage value of the standard signal.
-  Select **OK**. Return to *SP-SCALE*.
- ▲ / ▼ Select *SPmax*.
-  Select **INPUT**. The input screen is opened.
- ▲ / ▼ **+** Increase value and select **<-** decimal point.
Set scaling value (upper process set-point value). The value is assigned to the largest current or voltage value of the standard signal.
-  Select **OK**. Return to *SP-SCALE*.
-  Select **EXIT**. Return to *SETUP*.
- ✔ You have scaled the process set-point value.






If the submenu is left by pressing the left selection key **ESC**, the value remains unchanged.

15.2.5 *P.CO-INIT* – Smooth switchover MANUAL-AUTOMATIC

The smooth switchover between the MANUAL and AUTOMATIC operating states can be activated or deactivated in the *P.CO-INIT* menu.

Factory default setting: Smooth switchover activated.

Activate the smooth switchover of the operating states as follows:

- ▲ / ▼ Select *P.CO-INIT*
-  Select **ENTER**. The function (*bumpless*) and (*standard*) is displayed.
- ▲ / ▼ Select required function.
bumpless = smooth switchover activated
standard = smooth switchover deactivated
-  Select **SELECT**. The selection is marked by a filled circle ●.
-  Select **EXIT**. Return to *SETUP*.
- ✔ You have switched over the operating states.

15.3 PID.PARAMETER – Parameterizing the process controller

The following control parameters of the process controller are manually set in this menu.

DBND 1.0 %	Insensitivity range (dead band) of the process controller
KP 1.00	Amplification factor of the (P-component of the PID controller)
TN 999.0	Reset time (I-component of the PID controller)
TV 0.0	Hold-back time (D-component of the PID controller)
X0 0.0 %	Operating point
FILTER 0	Filtering of the process actual value input

The automatic parameterization of the PID controller integrated in the process controller (menu options *KP*, *TN*, *TV*) can be implemented with the aid of the *P.TUNE* function (see chapter „15.5 P.TUNE – Self-optimization of the process controller“).

The principles for setting the process controller can be found in chapters „28.2 Properties of PID Controllers“ and „28.3 Adjustment rules for PID Controllers“.

15.3.1 DBND – Insensitivity range (dead band)

This function causes the process controller to respond from a specific control difference only. This protects both the solenoid valves in Type 8692, 8693 and the pneumatic actuator.

Factory setting: 1.0 % with reference to the range of the scaled process actual value (setting in the menu *PV-SCALE* → *PVmin* → *PVmax*).

Enter the parameters as follows:

- ▲ / ▼ Select *PID.PARAMETER*.
- Select **ENTER**. The menu for parameterizing the process controller is displayed.
- ▲ / ▼ Select *menu option*.
- Select **INPUT**. The input screen is opened.
- ▲ / ▼ **+** Increase value and **-** reduce value
Set value for
- *

DBND X.X %

 /

X0 0 %

 /

FILTER 5

- Select **OK**. Return to *PID.PARAMETER*.
- Select **EXIT**. Return to *P.CONTROL*.
- Select **EXIT**. Return to the main menu (MAIN).
- Select **EXIT**. Return to *P.CONTROL*. Switching from setting level ⇔ process level.
- You have set the parameter.

If the submenu is left by pressing the left selection key **ESC**, the value remains unchanged.

Insensitivity range for process control

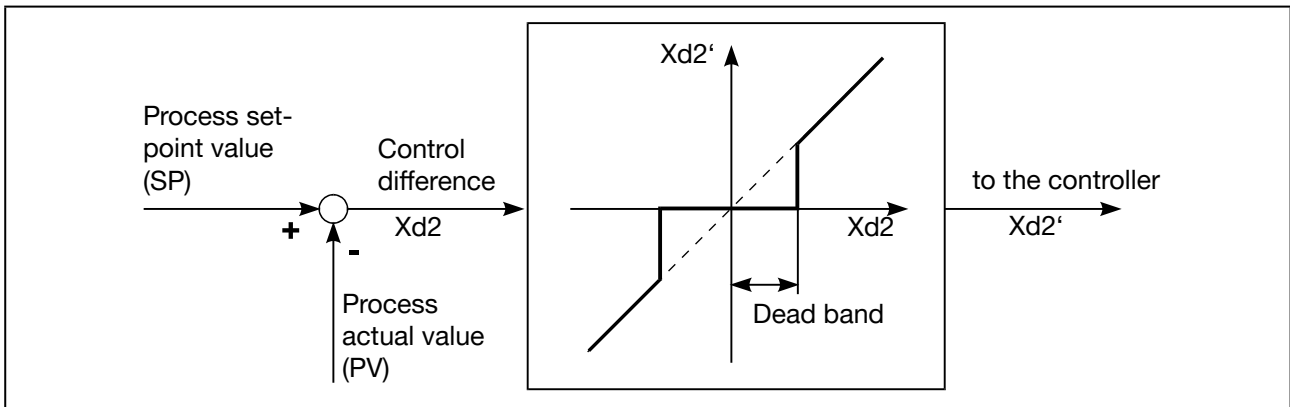


Figure 38: Diagram DBND; insensitivity range for process control

15.3.2 KP – Amplification factor of the process controller

The amplification factor specifies the P-contribution of the PID controller (can be set with the aid of the *P.TUNE* function).

Factory setting: 1.00

Enter the parameters as follows:

- ▲ / ▼ Select *PID.PARAMETER*.
- Select **ENTER**. The menu for parameterizing the process controller is displayed.
- ▲ / ▼ Select *menu option*.
- Select **INPUT**. The input screen is opened.
- ▲ / ▼ **<-** Select decimal point and **+** increase value
Set value for
- *

<i>KP</i>	X.XX
-----------	------

 /

<i>TN</i>	X.0 sec
-----------	---------

 /

<i>TV</i>	1.0 sec
-----------	---------

 :
- Select **OK**. Return to *PID.PARAMETER*.
- Select **EXIT**. Return to *P.CONTROL*.
- Select **EXIT**. Return to the main menu (MAIN).
- Select **EXIT**. Return to *P.CONTROL*. Switching from setting level ⇌ process level.
- ✔ You have set the parameter.

If the submenu is left by pressing the left selection key **ESC**, the value remains unchanged.

The *KP* amplification of the process controller refers to the scaled, physical unit.

15.3.3 TN – Reset time of the process controller

The reset time specifies the I-component of the PID controller, can be set with the *P.TUNE* function.

Factory setting: 999.9 s


Enter the parameters as follows:

→ ▲ / ▼ Select *PID.PARAMETER*.

→  Select **ENTER**. The menu for parameterizing the process controller is displayed.

→ ▲ / ▼ Select *menu option*.

→  Select **INPUT**. The input screen is opened.

→ ▲ / ▼  Select decimal point and  increase value


Set value for

TN	999.9
----	-------

→  Select **OK**. Return to *PID.PARAMETER*.

→  Select **EXIT**. Return to *P.CONTROL*.

→  Select **EXIT**. Return to the main menu (MAIN).

→  Select **EXIT**. Return to *P.CONTROL*. Switching from setting level ⇔ process level.

✔ You have set the parameter.



If the submenu is left by pressing the left selection key **ESC**, the value remains unchanged.


15.3.4 TV – Hold-back time of the process controller

The hold-back time specifies the D-contribution of the PID controller (can be set with the aid of the *P.TUNE* function).

Factory setting: 0.0 s



Enter the parameters as follows:

→ ▲ / ▼ Select *PID.PARAMETER*.

→  Select **ENTER**. The menu for parameterizing the process controller is displayed.

→ ▲ / ▼ Select *menu option*.


→  Select **INPUT**. The input screen is opened.

→ ▲ / ▼  Select decimal point and  increase value


Set value for


TV	0.0
----	-----

 :

→  Select **OK**. Return to *PID.PARAMETER*.

→  Select **EXIT**. Return to *P.CONTROL*.

→  Select **EXIT**. Return to the main menu (MAIN).

→  Select **EXIT**. Return to *P.CONTROL*. Switching from setting level ⇔ process level.

✔ You have set the parameter.



If the submenu is left by pressing the left selection key **ESC**, the value remains unchanged.


15.3.5 X0 – Operating point of the process controller

The operating point corresponds to the operating point of the proportional portion when control difference = 0.


Factory setting: 0.0 %

Enter the parameters as follows:

→ ▲ / ▼ Select *PID.PARAMETER*.

→  Select **ENTER**. The menu for parameterizing the process controller is displayed.


→ ▲ / ▼ Select *menu option*.

→  Select **INPUT**. The input screen is opened.


→ ▲ / ▼ **+** Increase value and **-** reduce value


Set value for

<i>X0</i>	0.0 %
-----------	-------

→  Select **OK**. Return to *PID.PARAMETER*.

→  Select **EXIT**. Return to *P.CONTROL*.

→  Select **EXIT**. Return to the main menu (MAIN).

→  Select **EXIT**. Return to *P.CONTROL*. Switching from setting level ⇔ process level.

✔ You have set the parameter.



If the submenu is left by pressing the left selection key **ESC**, the value remains unchanged.

15.3.6 FILTER – Filtering of the process actual value input

The filter is valid for all process actual value types and has a low-pass behavior (PT1).

Factory setting: 0

Enter the parameters as follows:

→ ▲ / ▼ Select *PID.PARAMETER*.

→  Select **ENTER**. The menu for parameterizing the process controller is displayed.

→ ▲ / ▼ Select *menu option*.

→  Select **INPUT**. The input screen is opened.

→ ▲ / ▼ **+** Increase value and **-** reduce value


Set value for

<i>FILTER</i>	0
---------------	---

→  Select **OK**. Return to *PID.PARAMETER*.

→  Select **EXIT**. Return to *P.CONTROL*.

→  Select **EXIT**. Return to the main menu (MAIN).

→  Select **EXIT**. Return to *P.CONTROL*. Switching from setting level ⇔ process level.

✔ You have set the parameter.



If the submenu is left by pressing the left selection key **ESC**, the value remains unchanged.

Setting the filter effect in 10 stages

Setting	Corresponds to cut-off frequency (Hz)
0 (Lowest filter effect)	10
1	5
2	2
3	1
4	0.5
5	0.2
6	0.1
7	0.07
8	0.05
9 (Largest filter effect)	0.03

Table 27: Setting the filter effect



In chapter „29 Tables for customer-specific settings“ you will find a table for entering your set parameters.

15.4 P.Q'LIN – Linearization of the process characteristic

This function automatically linearizes the process characteristic.


In doing so, the nodes for the correction characteristic are automatically determined. To do this, the program moves through the valve stroke in 20 steps and measures the associated process variable.

The correction characteristic and the associated value pairs are saved in the menu option *CHARACT* → *FREE*. This is where they can be viewed and freely programmed. For a description see chapter 16.1.3.

If the *CARACT* menu option has still not been activated and incorporated into the main menu (MAIN), this will happen automatically when *P.Q'LIN* is being run.

Run the P.Q'LIN as follows:

→ ▲ / ▼ Select *P.Q'LIN*. The function is in the main menu (MAIN) after activation of *P.CONTROL*.

→  Select **RUN**, hold down as long as countdown (5 ...) is running. *P.Q'LIN* is started.

The following displays are indicated on the display:

Q'LIN #0
CMD=0%

Q.LIN #1
CMD=10%

... continuing to


Q.LIN #10
CMD=100%

Display of the node which is currently running (progress is indicated by a progress bar along the upper edge of the display).

Q.LIN
ready

Automatic linearization was successfully completed.

→  Select **EXIT**. Return to the main menu (MAIN).

 You have set the parameter.

Possible fault messages when running *P.Q'LIN*:

Display	Cause of fault	Corrective action
Q.LIN err/break	Manual termination of linearization by pressing the EXIT key.	
P.Q'LIN ERROR 1	No supply pressure connected.	Connect supply pressure.
	No change to process variable.	Check process and, if required, switch on pump or open the shut-off valve. Check process sensor.
P.Q'LIN ERROR 2	Failure of the supply pressure while <i>P.Q'LIN</i> running.	Check supply pressure.
	Automatic adjustment of the <i>X.TUNE</i> position controller not run.	Run <i>X.TUNE</i> .

Table 28: *P.Q'LIN*; possible fault messages

15.5 *P.TUNE* – Self-optimization of the process controller

This function can be used to automatically parameterize the PID controller integrated in the process controller.

In doing so, the parameters for the P, I and D-component of the PID controller are automatically determined and transferred to the corresponding menus of (*KP*, *TN*, *TV*). This is where they can be viewed and changed.

Explanation of the PID controller:

The control system of Type 8693 has an integrated PID process controller. Any process variable, such as flow rate, temperature, pressure, etc., can be controlled by connecting an appropriate sensor.

To obtain good control behavior, the structure and parameterization of the PID controller must be adjusted to the properties of the process (controlled section).

This task requires control experience as well as measuring instruments and is time-consuming. The *P.TUNE* function can be used to automatically parameterize the PID controller integrated in the process controller.



The principles for setting the process controller can be found in chapters „28.2 Properties of PID Controllers“ and „28.3 Adjustment rules for PID Controllers“.

15.5.1 The operating mode of *P.TUNE*

The *P.TUNE* function automatically identifies the process. To do this, the process is activated with a defined disturbance variable. Typical process characteristics are derived from the response signal and the structure and parameters of the process controller are determined on the basis of the process characteristics.

When using *P.TUNE* self-optimization, optimum results are obtained under the following conditions:

- Stable or stationary conditions concerning the process actual value *PV* when starting *P.TUNE*.
- Execution of *P.TUNE* in the operating point or within the operating range of the process control.

15.5.2 Preparatory measure for execution of *P.TUNE*



The measures described below are not compulsory conditions for running the *P.TUNE* function. However, they will increase the quality of the result.


The *P.TUNE* function can be run in the MANUAL or AUTOMATIC operating state.

When *P.TUNE* is complete, the control system is in the operating state which was set previously.

15.5.2.1. Preparatory measures for execution of *P.TUNE* in the MANUAL operating state

Move the process actual value up to the operating point as follows:

→ ▲ / ▼ Select *PV*. The process actual value *PV* is indicated on the display.

→  Select **MANU**. Change to MANUAL operating state.
The input screen for manually opening and closing the valve is displayed.

→ ▲ Open valve **OPN** or ▼ close valve **CLS**
By opening or closing the control valve, move the process actual value to the required operating point.

→ As soon as the process actual value *PV* is constant, the *P.TUNE* function can be started.

✔ You have moved the process actual value *PV* to the operating point.

15.5.2.2. Preparatory measure for execution of *P.TUNE* in the AUTOMATIC operating state

By inputting a process set-point value *SP*, move the process actual value *PV* to the operating point.



Observe the internal or external set-point value default for the input (*P,CONTROL* → *SETUP* → *SP-INPUT* → *internal/external*):

For internal set-point value default: Enter the process set-point value *SP* via the keyboard of the device see description of the process set-point value below.

For external set-point value default: Enter the process set-point value *SP* via the analog set-point value input.


Enter the process set-point value as follows: (Setting on the process level)

→ ▲ / ▼ Select **SP**. The process set-point value is indicated on the display.

→  Select **INPUT**. The input screen for inputting the process set-point value is displayed.

→ ▲ / ▼ Input value  Select decimal point
 Increase value

The selected set-point value *SP* should be near the future operating point.

→  Select **OK**. Acknowledge input and return to the display of *SP*.

✔ You have inputted the process actual value.

The process variable *PV* is changed according to the set-point value default based on the factory default PID parameters.

→ Before running the *P.TUNE* function, wait until the process actual value *PV* has reached a stable state.



To observe *PV*, it is recommended to select via the arrow keys ▲ / ▼ the graphical display *SP/PV(t)*.

To be able to select the display *SP/PV(t)*, it must be activated in the *EXTRAS* menu (see chapter „16.2.1 EXTRAS – Setting the display“.

→ If *PV* oscillates continuously, the preset amplification factor of the process controller *KP* in the menu *P.CONTROL* → *PID.PARAMETER* should be reduced.

→ As soon as the process actual value *PV* is constant, the *P.TUNE* function can be started.

15.5.3 Starting the function *P.TUNE*




WARNING

Risk of injury from uncontrolled process.

While the *P.TUNE* function is running, the control valve automatically changes the current degree of opening and intervenes in the running process.

- ▶ Using suitable measures, prevent the permitted process limits from being exceeded.
 For example by:
 - an automatic emergency shutdown
 - stopping the *P.TUNE* function by pressing the STOP key (press left or right key).

Set the *P.TUNE* function as follows:

→  Press **MENU** for 3 s. Switching from process level ⇒ setting level.

→ ▲ / ▼ Select *P.TUNE*.

→  Hold down **RUN** as long as countdown (5 ...) is running.

During the automatic adjustment the following messages are indicated on the display.

“starting process tune” - Start self-optimization.

“identifying control process” - Process identification. Typical process variables are determined from the response signal to a defined stimulus.

“calculating PID parameters” - Structure and parameters of the process controller are determined.

“TUNE ready” - Self-optimization was successfully completed.

→ Press any key. Return to the main menu (MAIN).

→  Select **EXIT**. Switching from setting level ⇒ process level.

✔ You have set the *P.TUNE* function.



To stop *P.TUNE*, press the left or right selection key **STOP**.



The changed data is saved in the memory (EEPROM) only when there is a switch to the process level, by leaving the main menu (MAIN) using the left selection key **EXIT**.

Possible fault messages when running *P.TUNE*:

Display	Cause of fault	Corrective action
<i>TUNE</i> <i>err/break</i>	Manual termination of self-optimization by pressing the EXIT key.	
<i>P.TUNE</i> <i>ERROR 1</i>	No supply pressure connected.	Connect supply pressure.
	No change to process variable.	Check process and, if required, switch on pump or open the shut-off valve. Check process sensor.

Table 29: *P.TUNE*; possible fault messages

After making all the settings described in Chapter „14 Start-up“, the process controller is ready for use.

Activation and configuration of auxiliary functions are described in the following chapter „16 Auxiliary functions“.

16 AUXILIARY FUNCTIONS

The device has auxiliary functions for demanding control tasks.

This chapter describes how the auxiliary functions are activated, set and configured.

Overview and description of the auxiliary functions:

ADD.FUNCTION	Description
CHARACT	Selection of the transfer characteristic between input signal and stroke (correction characteristic)
CUTOFF	Sealing function for position controller
DIR.CMD	Effective direction between input signal and set-point position
DIR.ACT	Assignment of the aeration state of the actuator chamber to the actual position
SPLTRNG *	Signal split range; input signal as a % for which the valve runs through the entire stroke range.
X.LIMIT	Limit of the mechanical stroke range
X.TIME	Limit of the control speed
X.CONTROL	Parameterization of the position controller
P.CONTROL	Parameterization of the process controller
SECURITY	Code protection for settings
SAFEPOS	Input the safety position
SIG.ERROR	Configuration of signal level fault detection
BINARY.IN	Activation of the digital input
OUTPUT	Configuration of outputs (option)
CAL.USER	Calibration
SET.FACTORY	Reset to factory settings
SERVICE.BUES	Configuring the bÜS service interface
EXTRAS	Setting the display
SERVICE	For internal use only
SIMULATION	Simulation of set-point value, process valve, process
DIAGNOSE	Diagnostic menu (option)

* The SPLTRNG auxiliary function can only be selected if P.CONTROL (process control) is not activated.

Figure 39: Overview - auxiliary functions







16.1 Activating and deactivating auxiliary functions

The required auxiliary functions must be activated by the user initially by incorporation into the main menu (MAIN). The parameters for the auxiliary functions can then be set.

To deactivate a function, remove it from the main menu. This will cause the previous settings, created under this function, to be rendered invalid again.





16.1.1 Including auxiliary functions in the main menu

Add auxiliary functions to ADD.FUNCTION as follows:

-  Press **MENU** for 3 s. Switching from process level ⇒ setting level.
-  Select **ADD.FUNCTION**.
-  Select **ENTER**. The possible auxiliary functions are displayed.
-  Select required auxiliary function
-  Select **ENTER**. The selected auxiliary function is now marked by a cross ☒.
-  Select **EXIT**. Acknowledgment and simultaneous return to the main menu (MAIN).
The marked function is now activated and incorporated into the main menu.


✔ You have added the auxiliary functions.

Set the parameters of the auxiliary functions as follows:


-  Select auxiliary function. In the main menu (MAIN) select the auxiliary function.
-  Select **ENTER**. Opening the submenu to input the parameters.
Further information about the setting can be found in the following chapter „16 Auxiliary functions“.
- Select **EXIT*** or **ESC*** . Return to a higher level or to the main level (MAIN).
- Select **EXIT** . Switching from setting level ⇒ process level.

✔ You have parameterized the auxiliary functions.







* The designation of the key depends on the selected auxiliary function.

 The changed data is saved in the memory (EEPROM) only when there is a switch to the process level, by leaving the main menu (MAIN) using the left selection key **EXIT**.

16.1.2 Removing auxiliary functions from the main menu

 If a function is removed from the main menu, the settings implemented previously under this function become invalid again.

Remove auxiliary functions from ADD.FUNCTION as follows:

-  Press **MENU** for 3 s. Switching from process level ⇒ setting level.
-  Select **ADD.FUNCTION**.
-  Select **ENTER**. The possible auxiliary functions are displayed.
-  Select auxiliary function
-  Select **ENTER**. Remove function mark (no cross ☐).
-  Select **ENTER**. Acknowledgment and simultaneous return to the main menu (MAIN).
The marked function is now deactivated and removed from the main menu.

✔ You have removed the auxiliary functions.

16.1.3 CHARACT – Selection of the transfer characteristic between input signal (set-point position) and stroke

Characteristic (customer-specific characteristic)








Use this auxiliary function to select a transfer characteristic with reference to set-point value (set-point position, *CMD*) and valve stroke (*POS*) for correction of the flow line or operating characteristic.

Factory setting: *linear*



Each auxiliary function, which is to be set, must be incorporated initially into the main menu (MAIN). See chapter „16.1 Activating and deactivating auxiliary functions“.

Enter the freely programmable characteristic as follows:

-  Press **MENU** for 3 s. Switching from process level \Rightarrow setting level.
-  Select **CHARACT**. (To do this, the auxiliary function must be incorporated into the main menu).
-  Select **ENTER**. Menu options of **CHARACT** are displayed.
-  **linear** (linear characteristic)
 - GP 1:25: Equal percentage characteristic 1:25
 - GP 1:33: Equal percentage characteristic 1:33
 - GP 1:50: Equal percentage characteristic 1:50
 - GP 25:1: Inversely equal percentage characteristic 25:1
 - GP 33:1: Inversely equal percentage characteristic 33:1
 - GP 50:1: Inversely equal percentage characteristic 50:1
 - FREE: * User-defined characteristic, freely programmable via nodes
-  Select **SELECT**. The selection is marked by a filled circle .
- Select **EXIT** . Switching from setting level \Rightarrow process level.

The flow characteristic $k_v = f(s)$ indicates the flow-rate of a valve, expressed by the k_v value as a function of the stroke s of the actuator spindle. It is determined by the design of the valve seat and the valve seat seal. In general two types of flow characteristics are implemented, the linear and the equal percentage.

In the case of linear characteristics, equal k_v value changes dk_v are assigned to equal stroke changes ds .

$$(dk_v = n_{lin} \cdot ds).$$

In the case of an equal percentage characteristic, an equal percentage change to the k_v value corresponds to a stroke change ds .

$$(dk_v/k_v = n_{eqprct} \cdot ds).$$

The operating characteristic $Q = f(s)$ specifies the correlation between the flow rate Q in the installed valve and the stroke s . This characteristic has the properties of the pipelines, pumps and consumers. It therefore exhibits a form which differs from the flow characteristic.

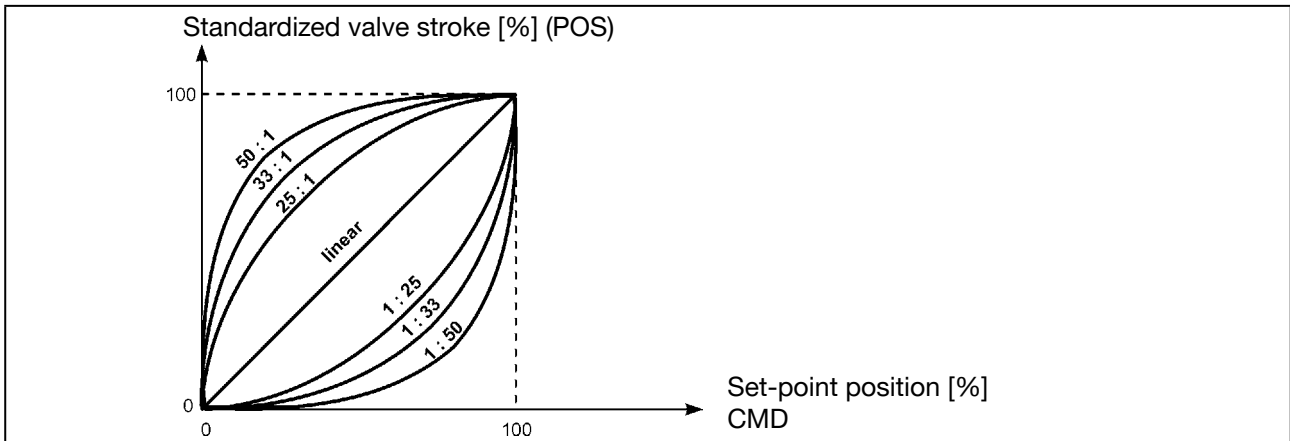


Figure 40: Characteristics

In the case of control tasks for closed-loop control systems it is usually particular demands which are placed on the course of the operating characteristic, e.g. linearity. For this reason it is occasionally necessary to correct the course of the operating characteristic in a suitable way. For this purpose Type 8692, 8693 features a transfer element which implements different characteristics. These are used to correct the operating characteristic.

Equal percentage characteristics 1:25, 1:33, 1:50, 25:1, 33:1, and 50:1 and a linear characteristic can be set. Furthermore, a characteristic can be freely programmed via nodes or automatically calibrated.

16.1.3.1. Entering the freely programmable characteristic

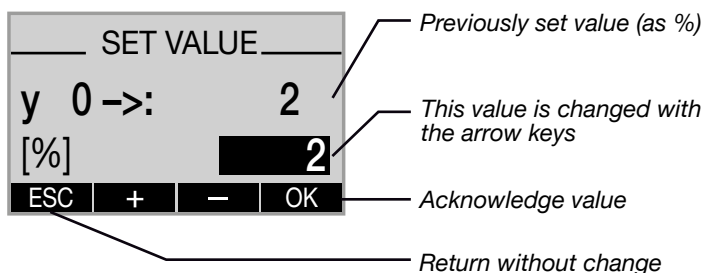
The characteristic is defined via 21 nodes which are distributed uniformly over the set-point position ranging from 0...100 %. They are spaced at intervals of 5%. A freely selectable stroke (adjustment range 0...100 %) can be assigned to each node. The difference between the stroke values of two adjacent nodes must not be greater than 20%.

Enter the freely programmable characteristic as follows:

- Press **MENU** for 3 s. Switching from process level \Rightarrow setting level.
- Select **CHARACT**. To do this, the auxiliary function must be incorporated into the main menu.
- Select **ENTER**. Menu options of **CHARACT** are displayed.
- Select **FREE**
- Select **SELEC**. The graphical display of the characteristic is displayed.
- Select **INPUT**. Submenu with the individual nodes (as %) is opened.
- Select node.

Select **INPUT**.

The **SET-VALUE** input screen for inputting values is opened.



- ▲ / ▼ Enter value: Input value for the selected node.
 - + Increase value
 - Reduce value
- Select **OK**. Acknowledge input and return to the *FREE* submenu.
- Select **EXIT**. Return to the *CHARACT* menu.
- Select **EXIT**. Return to the main menu (MAIN).
- Select **EXIT**. Switching from setting level ⇒ process level.
The changed data is saved in the memory (EEPROM).

✔ You have entered the freely programmable characteristic.

! The changed data is saved in the memory (EEPROM) only when there is a switch to the process level, by leaving the main menu (MAIN) using the left selection key **EXIT**.

Example of a programmed characteristic

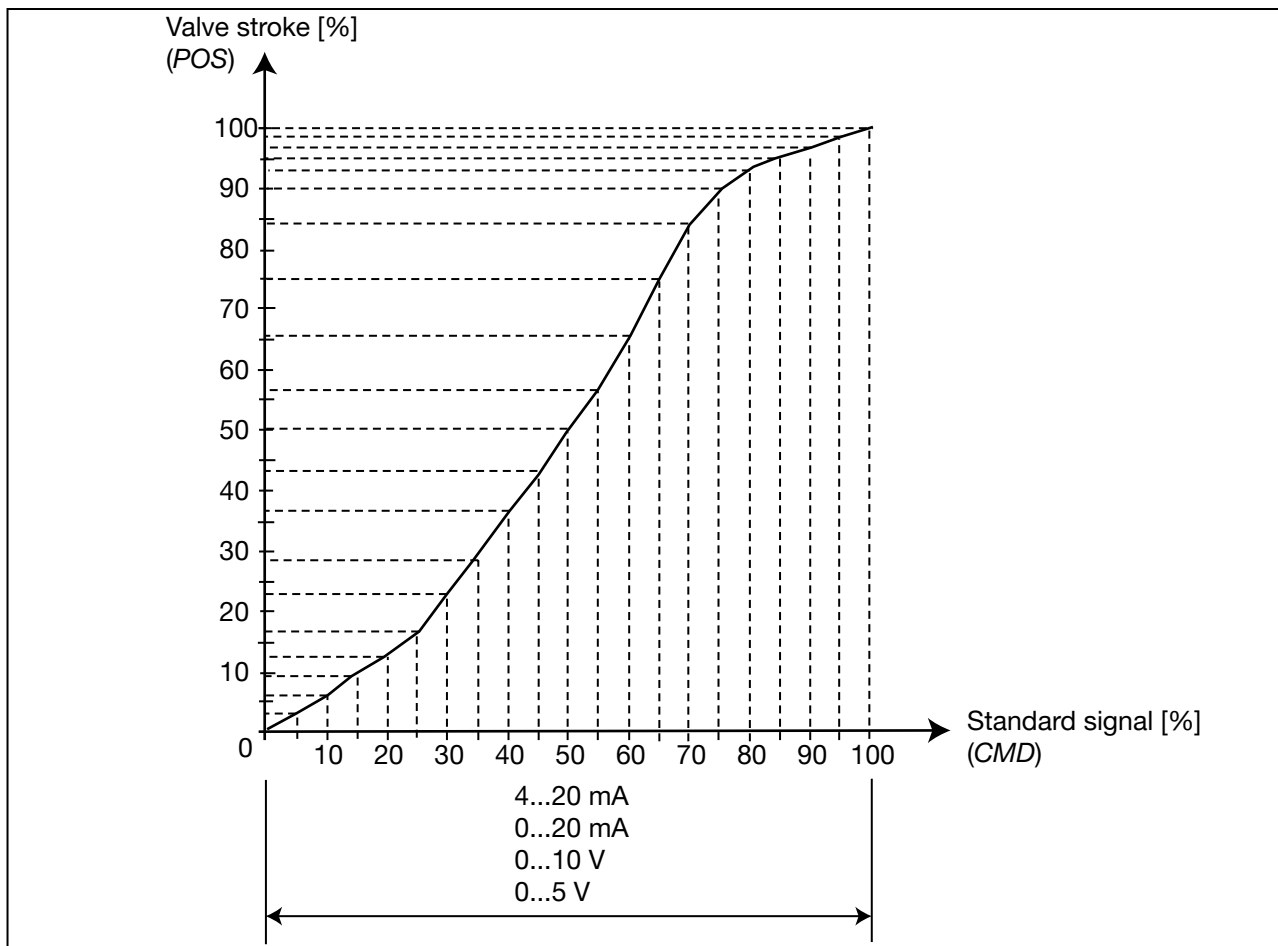


Figure 41: Example of a programmed characteristic

i In the section “[Tables for customer-specific settings](#)” chapter „[29.1.1 Settings of the freely programmable characteristic](#)“ includes a table in which you can enter your settings of the freely programmed characteristic.

16.1.4 CUTOFF – Sealing function

This function causes the valve to be sealed outside the control range.

To do this, the limits for the set-point position (*CMD*) are entered as a percentage from which the actuator is fully deaerated or aerated.

Controlled operation opens or resumes at a hysteresis of 1 %.

If the process valve is in the sealing area, the message “*CUTOFF ACTIVE*” is indicated on the display.

Only for type 8693: Here you can select the set-point value to which the sealing function is to apply:






Type PCO Process set-point value (*SP*)

Type XCO Set-point position (*CMD*)







If *Type PCO* was selected, the limits for the process set-point value (*SP*) are input as a percentage with reference to the scaling range.

Factory setting: *Min* = 0 %; *Max* = 100 %; *CUT type* = *Type PCO*

Enter *CUTOFF* as follows:

-  Press **MENU** for 3 s. Switching from process level ⇒ setting level.
- ▲ / ▼ Select **CUTOFF**. (To do this, the auxiliary function must be incorporated into the main menu).
-  Select **ENTER**. Menu options of *CUTOFF* are displayed.
-  Select **INPUT**.
The *Min* 0% input screen for inputting values is opened.
- ▲ / ▼ Enter value: Input value for the selected node.
 - + Increase value
 - Reduce value
-  Select **INPUT**.
The *Max* 100% input screen for inputting values is opened.
- ▲ / ▼ Enter value: Input value for the selected node.
 - + Increase value
 - Reduce value
-  Select **OK**. Acknowledge input and return to the *CUTOFF* submenu.
* If the submenu is left by pressing the **ESC** key, the value remains unchanged.

Or for type 8693:

-  Select **INPUT**.
The *CUT type** input screen for inputting values is opened. *Available for Type 8693 only
-  Select **SELEC**. The *Type PCO* input screen for inputting the selection of the process set-point value.
-  Select **SELEC**. The *Type XCO* input screen for inputting the selection of the set-point position.
-  Select **EXIT**. Return to the *CUTOFF* menu.
-  Select **EXIT**. Return to the main menu (MAIN).
-  Select **EXIT**. Switching from setting level ⇒ process level.
The changed data is saved in the memory (EEPROM).

 You have entered the *CUTOFF* sealing function.

! The changed data is saved in the memory (EEPROM) only when there is a switch to the process level, by leaving the main menu (MAIN) using the left selection key **EXIT**.

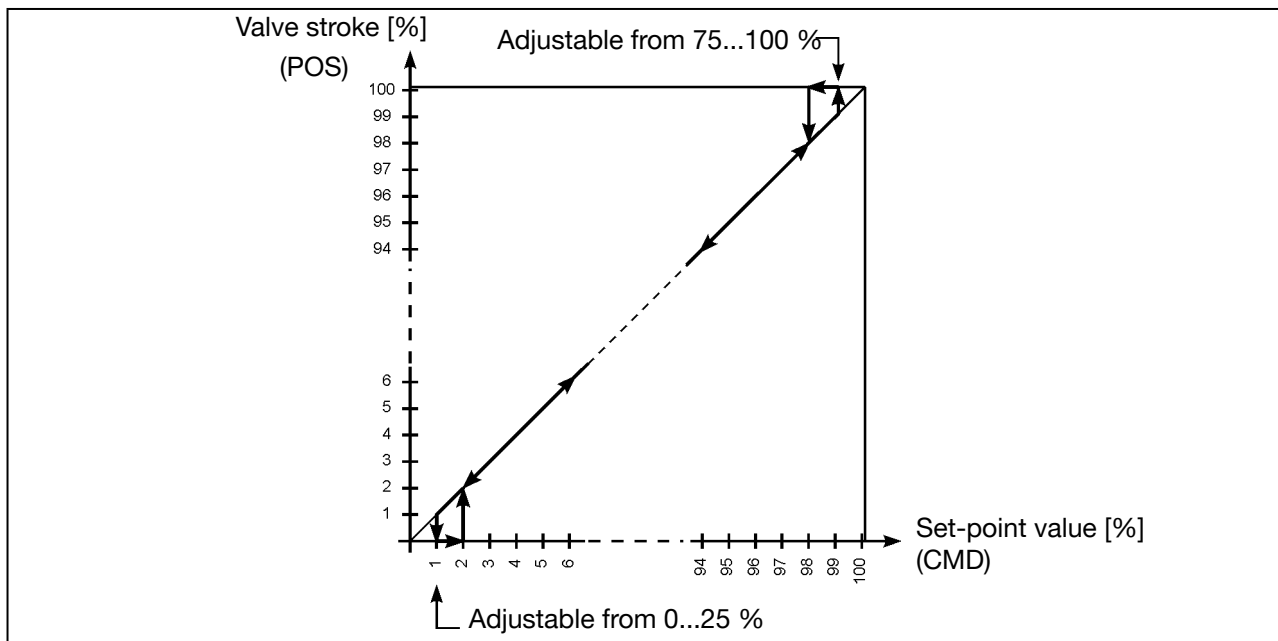


Figure 42: CUTOFF graph;


16.1.5 DIR.CMD – Effective direction of the position controller set-point value

You can use this auxiliary function to set the effective direction between the input signal (*INPUT*) and the set-point position (*CMD*) of the actuator.

! Each auxiliary function, which is to be set, must be incorporated initially into the main menu (*MAIN*). See chapter „16.1 Activating and deactivating auxiliary functions“.

Enter the effective direction of the position controller set-point value as follows: (Setting on the process level)

→ ▲ / ▼ Select *DIR.CMD*. The effective direction is indicated on the display.

→  Select **ENTER**. The input screen for inputting the effective direction is displayed.

→ ▲ / ▼ Select **SELEC**. *Rise*: direct effective direction (e.g. 4 mA or 0 V → 0 %, 20 mA or 5/10 V → 100 %)
 Fall: inverse effective direction (e.g. 4 mA or 0 V → 100 %, 20 mA or 5/10 V → 0 %)
 The selection is marked by a filled circle ●.

→  Select **EXIT**. Acknowledge input and return to the display of *DIR.CMD*.

✓ You have entered the effective direction of the position controller set-point value.

! The changed data is saved in the memory (EEPROM) only when there is a switch to the process level, by leaving the main menu (*MAIN*) using the left selection key **EXIT**.

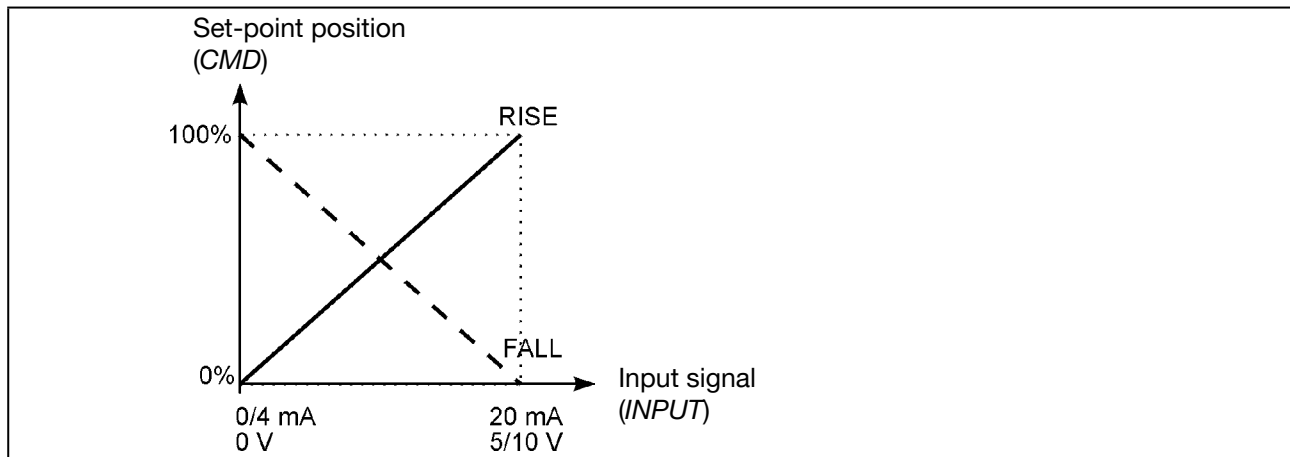


Figure 43: DIR.CMD graph


16.1.6 DIR.ACT – Effective direction of the actuating drive

Use this auxiliary function to set the effective direction between the aeration state of the actuator and the actual position (POS).

Factory setting: *Rise*

Enter the effective direction of the actuating drive as follows: (Setting on the process level)

→ ▲ / ▼ Select **DIR.ACT**. The effective direction is indicated on the display.

→  Select **ENTER**. The input screen for inputting the effective direction is displayed.

→ ▲ / ▼ Select **SELEC**. *Rise*: direct effective direction (deaerated → 0 %; aerated 100 %)
Fall: inverse effective direction (deaerated → 100 %; aerated 0 %)
 The selection is marked by a filled circle ●.

→  Select **EXIT**. Acknowledge input and return to the display of **DIR.ACT**.

✔ You have entered the effective direction of the actuating drive.

⚠ If the *Fall* function is selected here, the description of the arrow keys (on the display) changes to **MANUAL** operating state **OPN** → **CLS** and **CLS** → **OPN**
 Only when there is a switch to the process level, by leaving the main menu (MAIN) via the left selection key **EXIT**, is the modified data saved in the memory (EEPROM).

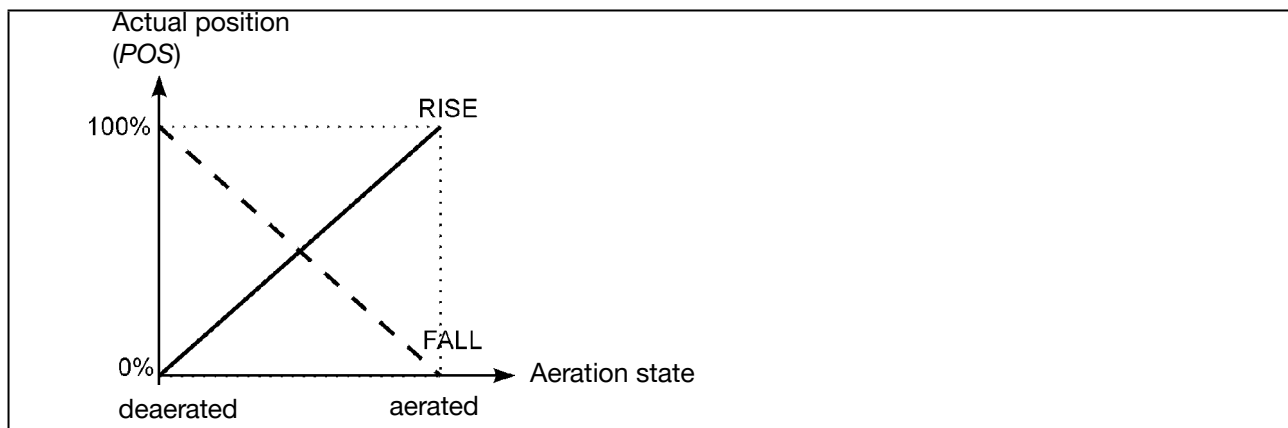


Figure 44: DIR.ACT graph

16.1.7 SPLTRNG – Signal split range

Min. and max. values of the input signal as % for which the valve runs through the entire stroke range.

Factory setting: $Min = 0\%$; $Max = 100\%$



**Type 8693: The SPLTRNG auxiliary function can only be selected when operating as a position controller.
P.CONTROL = not activated.**


Use this auxiliary function to limit the position set-point position range of Type 8692, 8693 by specifying a minimum and a maximum value.

As a result, it is possible to split a used standard signal range (4...20 mA, 0...20 mA, 0...10 V or 0...5 V) over several devices (without or with overlapping).

This allows several valves to be used **alternately** or, in the case of overlapping set-point value ranges, **simultaneously** as actuators.

Enter the signal split range as follows: (Setting on the process level)

→ ▲ / ▼ Select **SPLTRNG**. The effective direction is indicated on the display.

→  Select **ENTER**. The input screen for inputting the effective direction is displayed.

→  Select **INPUT**.

The *Min* 0% input screen for inputting values is opened.

→ ▲ / ▼ Enter value: Enter the minimum value of the input signal as %. Adjustment range: 0...75 %

+ Increase value
- Reduce value

→  Select **INPUT**.

The *Max* 100% input screen for inputting values is opened.

→ ▲ / ▼ Enter value: Enter the maximum value of the input signal as %.

Adjustment range: 25...100 %

+ Increase value
- Reduce value

→  Select **OK** *. Acknowledge input and return to the display of **SPLTRNG**.

✓ You have entered the signal split range.

* If the submenu is left by pressing the **ESC** key, the value remains unchanged.



The changed data is saved in the memory (EEPROM) only when there is a switch to the process level, by leaving the main menu (MAIN) using the left selection key **EXIT.**

Splitting a standard signal range into two set-point value ranges

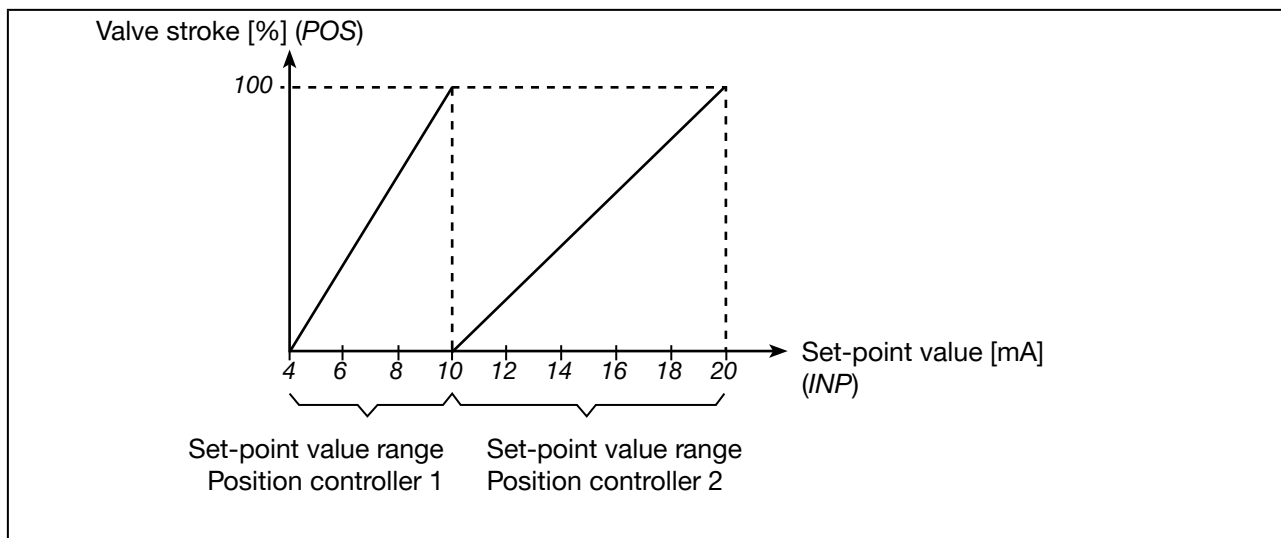


Figure 45: SPLTRNG graph





16.1.8 X.LIMIT – Limit of the mechanical stroke range


This auxiliary function limits the (physical) stroke to specified percentage values (minimum and maximum). In doing so, the stroke range of the limited stroke is set equal to 100 %.

If the limited stroke range is left during operation, negative *POS* values or *POS* values greater than 100 % are indicated.

Factory setting: *Min* = 0 %, *Max* = 100 %

Enter the limit of the mechanical stroke range as follows: (Setting on the process level)

- ▲ / ▼ Select **X.LIMIT**. The limit of the mechanical stroke range is indicated on the display.
-  Select **ENTER**. The input screen for inputting the mechanical stroke range is displayed.
-  Select **INPUT**.
The *Min* 0% input screen for inputting values is opened.
- ▲ / ▼ Enter value: Input the initial value of the stroke range as %.
Adjustment range: 0...50 % of the total stroke
 - + Increase value
 - Reduce value
-  Select **INPUT**.
The *Max* 100% input screen for inputting values is opened.
- ▲ / ▼ Enter value: Input the final value of the stroke range as %
Adjustment range: 50...100 % of the total stroke
 - + Increase value
 - Reduce value
-  Select **OK** *. Acknowledge input and return to the display of **X.LIMIT**.
The minimum gap between *Min* and *Max* is 50 %

 You have entered the limit of the mechanical stroke range.

* If the submenu is left by pressing the **ESC** key, the value remains unchanged.

! The changed data is saved in the memory (EEPROM) only when there is a switch to the process level, by leaving the main menu (MAIN) using the left selection key **EXIT**.

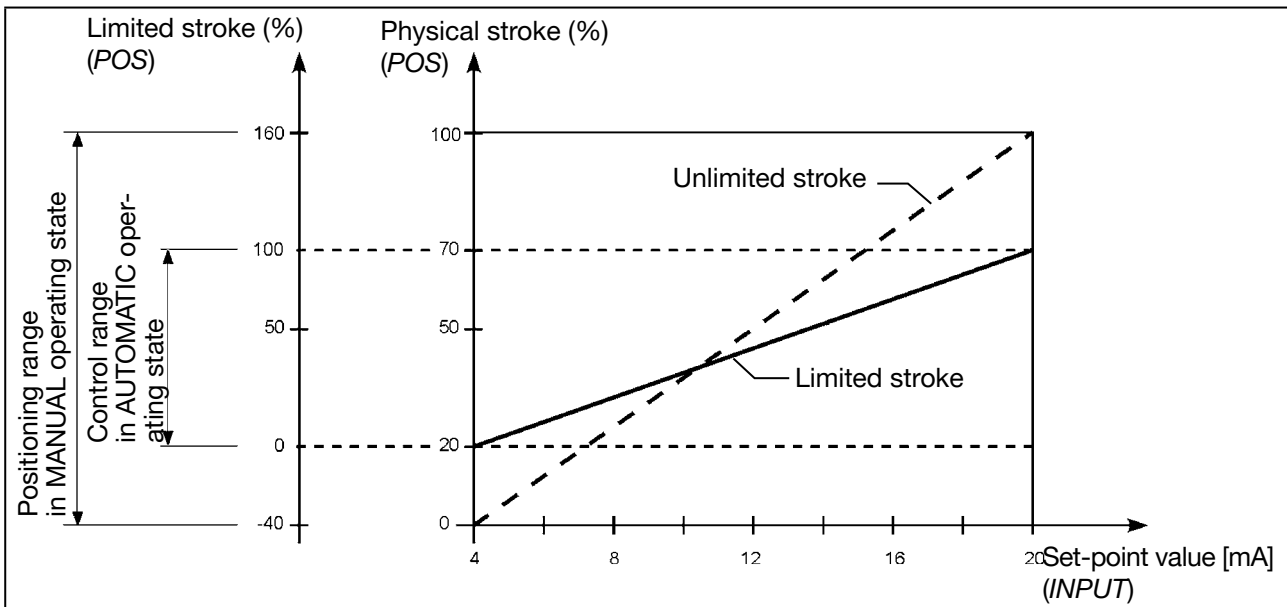


Figure 46: X.LIMIT graph

16.1.9 X.TIME - Limiting the control speed

Use this auxiliary function to specify the opening and closing times for the total stroke and to limit the control speeds.

! When the X.TIME function is running, the minimum opening and closing time for the entire stroke is automatically entered for *Open* and *Close*. Therefore, movement can be at maximum speed.

Factory setting: values determined at the factory by the X.TUNE function

If the control speed is limited, values can be input for *Open* and *Close* which are between the minimum values determined by the X.TUNE and 60 s.

Enter the limit of the control speed as follows: (Setting on the process level)

→ ▲ / ▼ Select **X.TIME**. The limit of the mechanical stroke range is indicated on the display.

→ Select **ENTER**. The input screen for inputting the limit of the control speed is displayed.

→ Select **INPUT**.
The *Open* 1 input screen for inputting values is opened.

→ ▲ / ▼ Enter value: Opening time for total stroke (in seconds)
Adjustment range: 1...60 seconds

- + Increase value
- Reduce value


→ Select **INPUT**.
The *Close* 1 input screen for inputting values is opened.

→ ▲ / ▼ Enter value: Closing time for total stroke (in seconds)

Adjustment range: 1...60 seconds

+ Increase value

- Reduce value

→  Select **OK** *. Acknowledge input and return to the display of *X.TIME*.

✔ You have entered the limit of the control speed.

* If the submenu is left by pressing the **ESC** key, the value remains unchanged.



The changed data is saved in the memory (EEPROM) only when there is a switch to the process level, by leaving the main menu (MAIN) using the left selection key **EXIT**.

Effect of limiting the opening speed when there is a jump in the set-point value

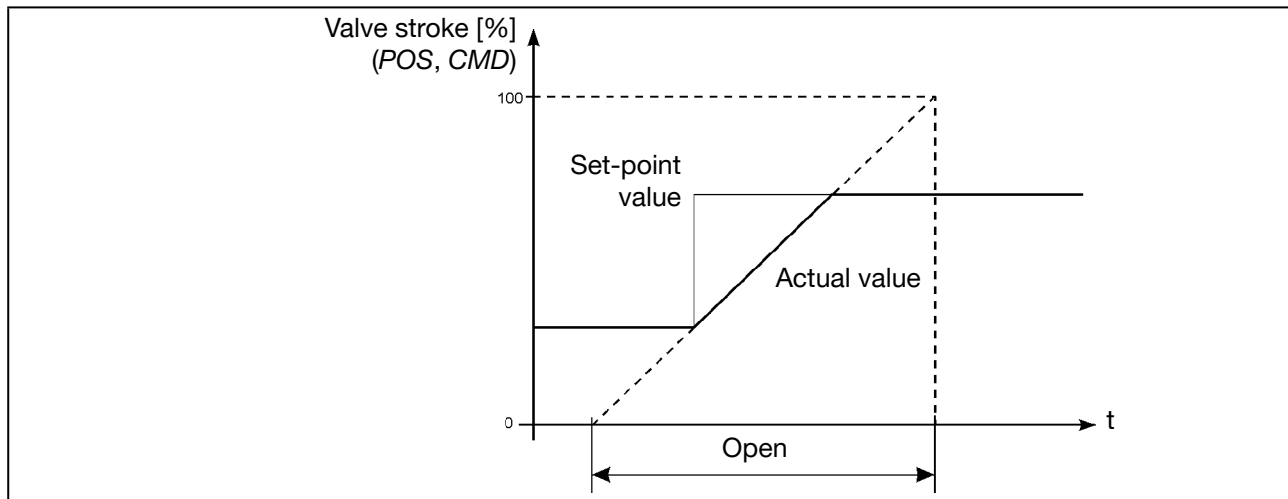


Figure 47: *X.TIME* graph

16.1.10 *X.CONTROL* – Parameterization of the position controller

This function can be used to re-adjust the parameters of the position controller. The re-adjustment should only be made if it is required for the application.

The parameters for *X.CONTROL* are automatically set with the exception of *DBND* (dead band) when specifying the basic settings by running *X.TUNE*.






If the setting for *DBND* (dead band depending on the friction behavior of the actuating drive) is also to be automatically determined when *X.TUNE* is running, *X.CONTROL* must be activated by incorporating it into the main menu (MAIN).

When *X.TUNE* is running, all previously re-adjusted values are overwritten (except the *X.TUNE* function was manually parameterized).

DBND	Insensitivity range (dead band)
KXopn	Amplification factor of the proportional portion (for aerating the valve)
KXcls	Amplification factor of the proportional portion (for deaerating the valve)
KDopn	Amplification factor of the differential portion (for aerating the valve)
KDcls	Amplification factor of the differential portion (for deaerating the valve)
YBfric	Friction correction (for aerating the valve)
YEfric	Friction correction (for deaerating the valve)

Enter the parameterization of the position controller as follows: (Setting on the process level)

- ▲ / ▼ Select **X.CONTROL**. The limit of the mechanical stroke range is indicated on the display.
-  Select **ENTER**. The input screen for parameterization of the position controller is displayed.
-  Select **INPUT**.
The input screen **DBND 1%**, **KXopn**, **KXcls**, **KDopn**, **KDcls**, **YBfric** and **YEfric** for inputting values is opened.
- ▲ / ▼ Enter value:

+	Increase value
-	Reduce value
-  Select **OK** *.

 You have input the parameterization of the position controller.

* If the submenu is left by pressing the **ESC** key, the value remains unchanged.

DBND Insensitivity range (dead band) of the position controller

Input the dead band as %, with reference to the scaled stroke range;
i.e. $X.LIMIT Max - X.LIMIT Min$ (see auxiliary function „16.1.8 X.LIMIT – Limit of the mechanical stroke range“).

This function causes the controller to respond only from a specific control difference; as a result the solenoid valves in Type 8692, 8693 and the pneumatic actuator are protected.

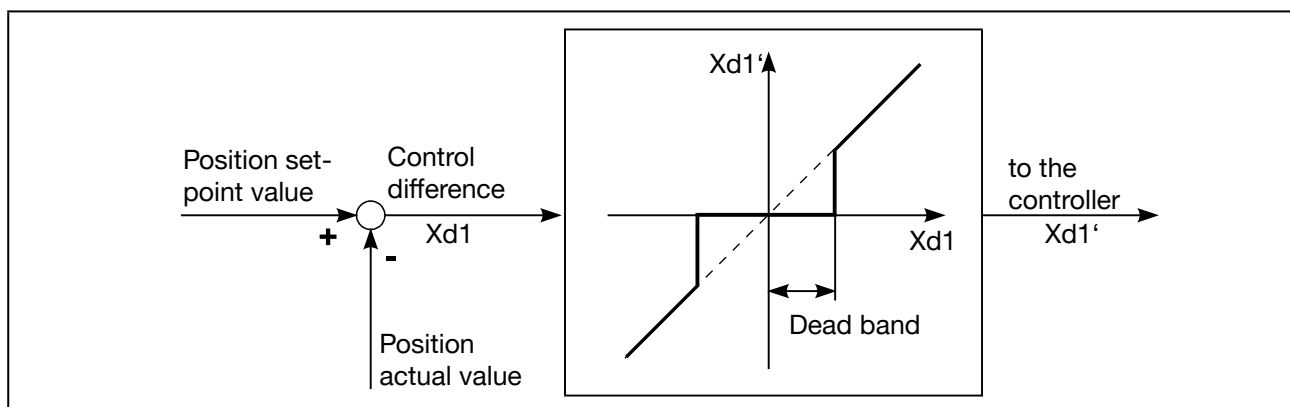


Figure 48: X.CONTROL graph

16.1.11 P.CONTROL – Setting up and parameterization of the process controller

The parameterization of the process controller is described in chapter „15.1 P.CONTROL – Setting up and parameterization of the process controller“.









16.1.12 SECURITY – Code protection for the settings

Use the *SECURITY* function to prevent Type 8692, 8693 or individual functions from being accessed unintentionally.

Factory setting: *Access Code*: 0000

If the code protection is activated, the code (set *Access Code* or master code) must be input whenever operator action is disabled.

Set the code protection as follows:

-  Press **MENU** for 3 s. Switching from process level ⇒ setting level.
- ▲ / ▼ Select *SECURITY* (To do this, the auxiliary function must be incorporated into the main menu).
-  Select **ENTER**. The input screen for the access code (*Access Code*) is displayed.
- ▲ / ▼ **<-** Select decimal point and **+** increase number.
Enter code.
For the first setting: *Access Code* 0000 (factory settings)
For activated code protection: *Access Code* from the user *
-  Select **OK**. The submenu of *SECURITY* is opened.
- ▲ / ▼ Select *CODE*.
-  Select **INPUT**.
The input screen for specifying the access code (*Access Code*) is displayed.
- ▲ / ▼ **<-** Select decimal point and **+** increase number.
Enter required access code.
-  Select **OK**. Acknowledgment and return to the *SECURITY* menu.
- ▲ / ▼ Select. Selector operator actions to which the code protection is to apply.
-  Select **SELECT**. Activate code protection by checking the box .
-  Select **EXIT**. Acknowledgment and simultaneous return to the main menu (MAIN).
-  Select **EXIT**. Switching from setting level ⇒ process level.

✔ You have set the code protection.



The changed data is saved in the memory (EEPROM) only when there is a switch to the process level, by leaving the main menu (MAIN) using the left selection key **EXIT**.



* If you have forgotten the set code:
All operator actions can be implemented with the non-changeable master code. This 4-digit master code can be found in the printed brief instructions for Type 8692, 8693.

16.1.13 SAFEPOS – Inputting the safety position

This function specifies the actuator safety position which is started at defined signals.



The set safety position is only started

- if a corresponding signal is applied to the digital input (configuration see *chapter „16.1.15 BINARY.IN – Activation of the digital input“*) or
- If a signal fault occurs (configuration see *chapter „16.1.14 SIG.ERROR – Configuration of signal level fault detection“*).

In the case of the bus variant, the safety position is also started with

- *BUS ERROR* (adjustable)

If the mechanical stroke range is limited with the *X.LIMIT* function, only safety positions within these limits can be started.

This function is run in **AUTOMATIC** operating state only.

Factory setting: 0 %

Enter the safety position as follows: (Setting on the process level)

→ ▲ / ▼ Select **SAFEPOS**. (To do this, the auxiliary function must be incorporated into the main menu).

→  Select **ENTER**. The input screen for parameterization of the position controller is displayed.

→  Select **INPUT**.

Enter the safety position adjustment range: 0...100 %**

→ ▲ / ▼ Enter value:

- + Increase value
- Reduce value

→  Select **OK** *.

✓ You have entered the safety position.

* If the submenu is left by pressing the **ESC** key, the value remains unchanged.

** If the safety position is 0 % or 100 %, the actuator is completely deaerated or aerated as soon as the safety position is active in the *SIG-ERROR* or *BINARY-IN* auxiliary functions.



The changed data is saved in the memory (EEPROM) only when there is a switch to the process level, by leaving the main menu (**MAIN**) using the left selection key **EXIT**.

16.1.14 SIG.ERROR – Configuration of signal level fault detection

The *SIG.ERROR* function is used to detect a fault on the input signal.

If signal fault detection is activated, the respective fault is indicated on the display. (see *chapter „22.3 Fault messages“*).

A fault detection on the input signal is only possible for signal types 4...20 mA and Pt 100. The particular menu branch is hidden for other signal types.

- **4...20 mA**: Fault if input signal ≤ 3.5 mA (± 0.5 % of final value, hysteresis 0.5 % of final value)
- **Pt 100** (can be set for process controller Type 8693 only):
Fault if input signal ≥ 225 °C (± 0.5 % of final value, hysteresis 0.5 % of final value)









The signal type is set in the following menus:





1. *INPUT* (for Types 8692 and 8693):
See chapter „14.2 *INPUT* - Setting the input signal“.
2. *P.CONTROL* (for Type 8693 only and when process controller activated):
See chapter „15.2.1 *PV-INPUT* – Specifying signal type for the process actual value“.


NOTE: The fault detection is only possible if the external set-point value default was selected in *SP-INPUT*. See chapter „15.2.3 *SP-INPUT* – Type of the set-point value default (internal or external)“.

Set the signal fault detection for input signal as follows: (Setting on the process level)

- ▲ / ▼ Select *SIG.ERROR*. (To do this, the auxiliary function must be incorporated into the main menu).
-  Select **ENTER**. The input screen for setting the signal fault detection for input signal is displayed.
- ▲ / ▼ Select *SP/CMD Input*. *SP* = process set-point value, *CMD* = set-point position
-  Select **ENTER**.
- ▲ / ▼ Select *Error off* (deactivate signal fault detection).
Select *Error on* (activate signal fault detection).
-  Select **SELEC**. The selection is marked by a filled circle ●.
- ▲ / ▼ Select *SAFEPOS* (Deactivating/activating approach of the safety position*).
- ▲ / ▼ Select *SafePos off*.
Select *SafePos on***.
-  Select **SELEC**. The selection is marked by a filled circle ●.
-  Select **EXIT** and return to the *SP/CMD Input* menu.
-  Select **EXIT** and return to the *SIG.ERROR* menu.

For Type 8693 only (process control):

- ▲ / ▼ Select *SIG.ERROR*. (To do this, the auxiliary function must be incorporated into the main menu).
-  Select **ENTER**. The input screen for setting the signal fault detection for input signal is displayed.
- ▲ / ▼ Select *PV-Input*. *PV* = process actual value
-  Select **ENTER**.
- ▲ / ▼ Select *Error off* (deactivate signal fault detection).
Select *Error on* (activate signal fault detection).
-  Select **SELEC**. The selection is marked by a filled circle ●.
- ▲ / ▼ Select *SAFEPOS* (Deactivating/activating approach of the safety position*).
- ▲ / ▼ Select *SafePos off*.
Select *SafePos on***.
-  Select **SELEC**. The selection is marked by a filled circle ●.

→  Select **EXIT** and return to the SP/CMD Input menu.

→  Select **EXIT** and return to the *SIG.ERROR* menu.

✓ You have set the signal fault detection for input signal.

* Approaching the safety position can be set only when signal fault detection (Error on) has been activated. When signal fault detection (Error off) has been deactivated, the message “not available” is indicated.

** For behavior of the actuator during a signal fault detection see the following description.

16.1.14.1. Behavior of the actuator when safety position deactivated or activated

Selection – The actuator moves to the set-point value according to the measured input signals (default setting): A faulty 4..20 mA signal is detected as 4.0 mA, a faulty Pt 100 signal is detected as 220 °C.

Selection – Approaching the safety position:

In the event of a signal fault detection, the behavior of the actuator depends on the activation of *SAFEPOS* auxiliary function. See chapter „16.1.13 *SAFEPOS* – Inputting the safety position“.

- Auxiliary function *SAFEPOS* activated: In the event of a signal fault detection the actuator moves to the position which is specified in the *SAFEPOS* auxiliary function.
- Auxiliary function *SAFEPOS* not activated: The actuator moves to the safety end position which it would assume if the electrical auxiliary power failed. See chapter „10.8 Safety end positions after failure of the electrical or pneumatic auxiliary power“.



The activation for approaching the safety position (selection *SafePos on*) is possible only when signal fault detection has been activated (*ERROR on*).

16.1.15 *BINARY.IN* – Activation of the digital input

The digital input is configured in this menu. The following functions can be assigned to it:


- Approaching *SafePos*
- Switching over the operating state (MANUAL / AUTOMATIC)
- Starting the function *X.TUNE*







Only for type 8693 and when process controller activated:

- Switching between position controller and process controller

Activate the digital inputs as follows: (Setting on the process level)

→ ▲ / ▼ Select *BINARY.IN*. (To do this, the auxiliary function must be incorporated into the main menu).

→  Select **ENTER**. The input screen for activating the digital inputs is displayed.

- ▲ / ▼ Select different BIN.IN.
Select *SafePos*. Approaching *SafePos*,
select *Manu/Auto*. Switch over operating state,
select *X.Tune*. Start *X.TUNE*,
select *X.CO / P.CO*. Switching between position controller and process controller or
select *BIN.IN* type and activate normally open or normally closed .
-  Select **SELECT**. The selection is marked by a filled circle .
-  Select **EXIT**
-  Select **EXIT**. Switching from setting level \Rightarrow process level.
-  You have activated the digital inputs.

SafePos – Approaching a safety position:

The behavior of the actuator depends on the activation of the *SAFEPOS* auxiliary function.
See chapter „16.1.13 *SAFEPOS* – Inputting the safety position“.

SAFEPOS activated: The actuator moves to the safety position which is specified in the *SAFEPOS* auxiliary function.

SAFEPOS deactivated: The actuator moves to the safety end position which it would assume if the electrical and pneumatic auxiliary power failed.
See chapter „10.8 Safety end positions after failure of the electrical or pneumatic auxiliary power“.

Digital input = 1 → Actuator moves to the set safety position.

Manu/Auto – Switching between the MANUAL and AUTOMATIC operating states:

Digital input = 0 → AUTOMATIC **AUTO** operating state

Digital input = 1 → MANUAL **MANU** operating state



If the *Manu/Auto* function was selected in the *BINARY.IN* menu, it is no longer possible to change the operating state on the process level using the **MANU** and **AUTO** keys.

X.TUNE – Starting the function X.TUNE:

Digital input = 1 → Start *X.TUNE*

X.CO/P.CO – Switching between position controller and process controller:

This menu option stands only for Type 8693 and is available when process controller (*P.CONTROL*) has been activated.

Digital input = 0 → Position controller (*X.CO*)

Digital input = 1 → Process controller (*P.CO*)

16.1.16 OUTPUT – Configuration of the outputs (option)



The **OUTPUT** menu option is only indicated in the selection menu of **ADD.FUNCTION** if Type 8692, 8693 has outputs (option).

Type 8692, 8693, which has the outputs option, is available in the following variants:

- an analog output
- an analog output and two digital outputs
- two digital outputs




According to the variant of Type 8692, 8693, only the possible adjustable outputs (**ANALOG**, **ANALOG + BIN 1 + BIN 2** or **BIN 1 + BIN 2**) are indicated in the **OUTPUT** menu option.

Configure the outputs as follows: (Setting on the process level)


→ ▲ / ▼ Select **OUTPUT**. (To do this, the auxiliary function must be incorporated into the main menu).

→  Select **ENTER**. The input screen for configuring the outputs is displayed.


→ ▲ / ▼ Select **OUT ANALOG**.


→  Select **ENTER** and configure the analog output.

→ ▲ / ▼ Select **OUT BIN1**.

→  Select **ENTER** and configure the digital output 1.

→ ▲ / ▼ Select **OUT BIN2**.

→  Select **ENTER** and configure the digital output 2.

→  Select **EXIT**. Switching from setting level ⇒ process level.

✔ You have configured the outputs.

16.1.16.1. OUT ANALOG - Configuration of the analog output

Type 8692: The feedback of the current position (**POS**) or of the set-point value (**CMD**) can be transmitted to the control center via the analog output.

Type 8693: The feedback of the current position (**POS**) or of the set-point value (**CMD**), of the process actual value (**PV**) or of the process set-point value (**SP**) can be transmitted to the control center via the analog output.

Configure the analog output as follows: (Setting on the process level)
















→ ▲ / ▼ Select **OUT ANALOG**. (To do this, the auxiliary function must be incorporated into the main menu).

→  Select **ENTER**. The input screen for configuring the analog output is displayed.

→ ▲ / ▼ Select **POS**. Output of the actual position.

→  Select **SELEC**. The selection is marked by a filled circle ●.


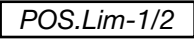
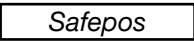


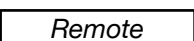
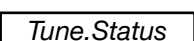

→ ▲ / ▼ Select **CMD**. Output of the set-point position.

-  Select **SELEC**. The selection is marked by a filled circle .
-  Select **PV**. Output of the process actual value. (For Type 8693 only, process control)
-  Select **SELEC**. The selection is marked by a filled circle .
-  Select **SP**. (For Type 8693 only (process control)
-  Select **SELEC**. Output of the process set-point value.
-  Select **OUT.type**. Selection of the standard signal.
-  Select **ENTER** and configure the standard signal.
-  Select standard signal.
-  Select **SELECT**. The selection is marked by a filled circle .
-  Select **EXIT** and return to the OUT.type menu.
-  Select **EXIT** and return to the OUT ANALOG menu.
-  You have configured the analog output.

16.1.16.2. OUT BIN1 / OUT BIN2 - Configuring the digital outputs

The following description is valid for both digital outputs *OUT BIN 1* and *OUT BIN 2*, as the operation in the menu is identical.

The digital outputs 1 and 2 can be used for one of the following outputs:

 <i>POS.Dev</i>	Exceeding the permitted control deviation
 <i>POS.Lim-1/2</i>	Current position with respect to a specified limit position (> or <)
 <i>Safepos</i>	Actuator is moved to safety position
 <i>ERR.SP/CMD</i>	Sensor break (SP = process set-point value, CMD = set-point value position)
 <i>ERR.PV</i>	Sensor break (process actual value). Available for Type 8693 only.
 <i>Remote</i>	Operating state (AUTOMATIC / MANUAL)
 <i>Tune.Status</i>	Status <i>X.TUNE</i> (process optimization)
 <i>DIAG.State-1/2</i>	Diagnostic output (option)

Overview of possible outputs and associated switching signals:

Menu option	Switching signal	Description
POS.Dev	0	Control deviation is within the set limit.
	1	Control deviation is outside the set limit.
POS.Lim-1/2	0	Actual position is above the limit position.
	1	Actual position is below the limit position.
Safepos	0	Safety position is not approached.
	1	Safety position is approached.
ERR.SP/CMD	0	No sensor break available.
ERR.PV	1	Sensor break available.
Remote	0	Appliance is the AUTOMATIC operating state.
	1	Appliance is the MANUAL operating state.
Tune.Status	0	The X.TUNE function is currently not running.
	1	The X.TUNE function is currently running.
	0/1 alternating (10 s)	The X.TUNE function was stopped during execution by a fault.
DIAG.State-1/2	0	No diagnostic message available for the selected status signals.
	1	Diagnostic message available for the selected status signals.




Table 30: OUT BIN 1/2; Possible outputs and associated switching signals

Switching signal	Switching statuses	
	normally open	normally closed
0	0 V	24 V
1	24 V	0 V

Table 31: OUT BIN 1/2; switching statuses

16.1.16.3. Setting of the submenu options of OUT BIN 1 and OUT BIN 2





Open the submenus as follows:

-  Press **MENU** for 3 s. Switching from process level ⇒ setting level.
- ▲ / ▼ Select **OUTPUT** (to do this, the auxiliary function must be incorporated into the main menu).
-  Select **ENTER**. The outputs are displayed.
- ▲ / ▼ Select **OUT BIN1/2**
-  Select **ENTER**. Submenu options of **OUT BIN 1/2** are displayed.
- ✔ You have opened the submenus.





- **POS.Dev** - Alarm output for excessively large control deviation of the position controller
- **POS.Lim-1/2** - Output of the current position with respect to a specified limit position

Set the suboptions **OUT BIN 1** and **OUT BIN 2** as follows:

POS.Dev - Alarm output for excessively large control deviation of the position controller:

- ▲ / ▼ Select **POS.Dev**
-  Select **SELEC**. The input screen for the limit value (*Deviation:*) is opened.
- ▲ / ▼  Increase value
 Reduce value
 Enter limit value for permitted control deviation.
 Adjustment range: 1...50 % (must not be less than the dead band).
-  Select **OK**. Acknowledgment and simultaneous return to the **OUT BIN 1/2** menu.
 Then set the required switching status in the **OUT.type** submenu.

POS.Lim-1/2 - Output of the current position with respect to a specified limit position:

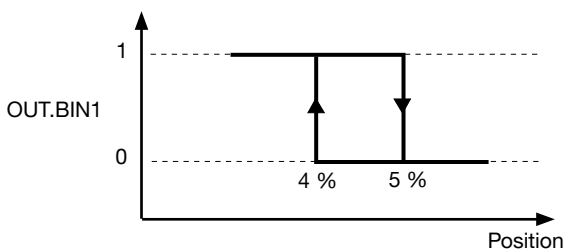
- ▲ / ▼ Select **POS.Lim-1/2**
-  Select **SELEC**. The input screen for the limit position (*Limit:*) is opened.
- ▲ / ▼  Increase value
 Reduce value
 Enter limit position.
 Adjustment range: 0...100 %.
-  Select **OK**. Acknowledgment and simultaneous return to the **OUT BIN 1/2** menu.
 Then set the required switching status in the **OUT.type** submenu.
- ✔ You have set the submenus.

- The digital outputs are equipped with a hysteresis of 1%.
- This hysteresis must be observed when setting the switching thresholds for the digital outputs.
- Example: digital output 1 switches when POS < 4% falls short and digital output 2 when POS > 96% is exceeded.

Digital output 1 (OUT.BIN1): Hysteresis for lower switching threshold 4% → Normally Open, Output signal high when signal active

POS.LIM = 4 %

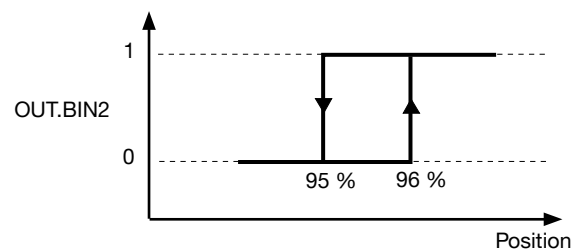
POS.LIM = 4 %



Digital output 2 (OUT.BIN2): Hysteresis for upper switching threshold 96% → Normally Closed, Output signal low when signal active

POS.LIM = 95 %


POS.LIM = 95 %



- **Safepos** - Outputting the message: Actuator in safety position
- **ERR.SP/CMD** - Outputting the message: Sensor break for process set-point value/set-point position
Only available if the function in the *SIG.ERR* menu has been activated (*SIG.ERR* → *SP/CMD input* → *Error on*).
See chapter „16.1.14 SIG.ERROR – Configuration of signal level fault detection“.
- **ERR.PV** - Outputting the message: Sensor break for process actual value (for Type 8693 only)
Only available if the function in the *SIG.ERR* menu has been activated (*SIG.ERR* → *PV Input* → *Error on*).
See chapter „16.1.14 SIG.ERROR – Configuration of signal level fault detection“.
- **Remote** - Output AUTOMATIC / MANUAL operating state
- **Tune.Status** - Output TUNE (process optimization)

Specify the output as follows:

→ ▲ / ▼ Select *suboptions*. (*Safepos*, *ERR.SP/CMD*, *ERR.PV*, *Remote* or *Tune.Status*).

→  Select **SELEC**. Acknowledge submenu option as output function for the digital output. The selection is marked by a filled circle ●.
Then set the required switching status in the *OUT.type* submenu.

✔ You have specified the output.


- **DIAG.State-1/2 - Diagnostic output (option)**

- Outputting the message: Diagnostic message from selected status signal


- Description see chapter „16.2.4 DIAGNOSE – Menu for monitoring valves (option)“.

Enter the *OUT.type* as follows:


→ ▲ / ▼ Select *DIAG.State-1/2*.

→  Select **SELEC**. The status signals, which can be activated for outputting the message, are displayed.

→ ▲ / ▼ Select *status signal*. Select the status signal which is to be assigned to the diagnostic output.

→  Select **SELEC**. Activate the selection by checking the box or deactivate it by unchecking the box .

→ If required, activate further status signals for the diagnostic output by pressing the ▲ / ▼ and **SELEC** keys.

→  Select **EXIT**. Acknowledgment and simultaneous return to the *OUT BIN 1/2* menu. Then set the required switching status in the *OUT.type* submenu.

✔ You have input *OUT.type*.


- ***OUT.type* - Setting the switching status**

- In addition to selecting the output, the switching status required for the digital output must be input.

- See „Table 32: *OUT BIN 1/2*; switching statuses“.


Enter the *OUT.type* as follows:

→ ▲ / ▼ Select *OUT.type*.


→  Select **SELEC**. The switching statuses *normally open* and *normally closed* are displayed.


→ ▲ / ▼ Select switching status.

→  Select **SELEC**. The selection is marked by a filled circle ●.

→  Select **EXIT**. Acknowledgment and simultaneous return to the *OUT BIN 1/2* menu.

→  Select **EXIT**. Acknowledgment and simultaneous return to the *OUTPUT* menu.

→  Select **EXIT**. Acknowledgment and simultaneous return to the main menu (MAIN).

→  Select **EXIT**. Switching from setting level ⇒ process level.

✔ You have input *OUT.type*.

Switching signal	Switching statuses	
	normally open	normally closed
0	0 V	24 V
1	24 V	0 V

Table 32: *OUT BIN 1/2*; switching statuses



The changed data is saved in the memory (EEPROM) only when there is a switch to the process level, by leaving the main menu (MAIN) using the left selection key **EXIT**.

16.1.17 CAL.USER – Calibration of actual value and set-point value

The following values can be manually calibrated with this function:

- Position actual value (0...100 %)
- Set-point position (4...20 mA, 0...20 mA, 0...5 V, 0...10 V)
For the calibration process the signal type is displayed which was specified for the input signal.
See chapter „14.2 INPUT - Setting the input signal“.

Type 8693:

The following values can be calibrated only for Type 8693 and activated process controller (*P.CONTROL*).

- Process set-point value (4...20 mA, 0...20 mA, 0...5 V, 0...10 V)
For the calibration process the signal type is displayed which was specified for the input signal.
See chapter „14.2 INPUT - Setting the input signal“.



The calibration of the process set-point value is only possible if the external set-point value default was selected when setting up the process controller.
See chapter „15.2.3 SP-INPUT – Type of the set-point value default (internal or external)“.
Setting: *P.CONTROL* → *SETUP* → *SP-INPUT* → *external*



- Process actual value (4...20 mA or *C)
For the calibration process the signal type is displayed which was specified for the process actual value when setting up the process controller.
See chapter „15.2.1 PV-INPUT – Specifying signal type for the process actual value“.









The frequency signal type (flow rate) cannot be calibrated.
If the frequency was set when setting up the process controller (*P.CONTROL* → *SETUP* → *PV-INPUT* → *Frequency*), the *calibr. PV* menu option is hidden.

16.1.17.1. Calibration of the position actual value and the set-point position







Calibrate **CAL.USER** as follows:

-  Press **MENU** for 3 s. Switching from process level ⇒ setting level.
- ▲ / ▼ Select **CAL.USER**. (To do this, the auxiliary function must be incorporated into the main menu).
-  Select **ENTER**. The submenu options are displayed.

calibr. POS - Calibration of the position actual value (0...100 %):

- ▲ / ▼ Select *calibr.POS*.
-  Select **ENTER**. The menu options for the minimum and the maximum position actual values are displayed.
- ▲ / ▼ Select *POS. pMin*.
-  Select **INPUT**. The input screen for the lower value (*POS.lower*) is opened.
- ▲ / ▼ Select **OPN** open more
CLS close more. Approach minimum position of the valve.
-  Select **OK**. Transfer and simultaneous return to the *calibr.POS* menu.
- ▲ / ▼ Select *POS. pMax*.
-  Select **INPUT**. The input screen for the upper value (*POS.upper*) is opened.
- ▲ / ▼ Select **OPN** open more
CLS close more. Approach maximum position of the valve.
-  Select **OK**. Transfer and simultaneous return to the *calibr.POS* menu.
-  Select **EXIT**. Acknowledgment and simultaneous return to the **CAL.USER** menu.



calibr. INP - Calibration of the set-point position (4...20 mA, 0...20 mA, 0...5 V, 0...10 V):

- ▲ / ▼ Select *calibr.INP*.
-  Select **ENTER**. The menu options for the minimum and maximum value of the input signal are displayed.
- ▲ / ▼ Select *INP 0 mA (4mA/0V)*. The minimum value for the input signal is displayed.
- Apply the minimum value to the input.
-  Select **OK**. Transfer and simultaneous return to the *calibr.INP* menu.
- ▲ / ▼ Select *INP 20 mA (5V/10V)*. The maximum value for the input signal is displayed.
- Apply the maximum value to the input.
-  Select **OK**. Transfer and simultaneous return to the *calibr.INP* menu.
-  Select **EXIT**. Acknowledgment and simultaneous return to the **CAL.USER** menu.
-  Select **EXIT**. Acknowledgment and simultaneous return to the main menu (MAIN).
-  Select **EXIT**. Switching from setting level ⇒ process level.





 You have calibrated **CAL.USER**.

16.1.17.2. Calibration of the process set-point value and the process actual value





Calibrate *CAL.USER* as follows:

-  Press **MENU** for 3 s. Switching from process level ⇔ setting level.
- ▲ / ▼ Select *CAL.USER*. (To do this, the auxiliary function must be incorporated into the main menu).
-  Select **ENTER**. The submenu options are displayed.


calibr. SP - Calibration of the process set-point value:




- ▲ / ▼ Select *calibr. SP*.
-  Select **ENTER**. The menu options for the minimum and the maximum process set-point value are displayed.
- ▲ / ▼ Select *SP 0 mA (4mA/0V)*. The minimum value for the input signal is displayed.
- Apply the minimum value to the input.
-  Select **OK**. Transfer and simultaneous return to the *calibr.SP* menu.
- ▲ / ▼ Select *SP 20 mA (5V/10V)*. The maximum value for the input signal is displayed.
- Apply the maximum value to the input.
-  Select **OK**. Transfer and simultaneous return to the *calibr.SP* menu.
-  Select **EXIT**. Acknowledgment and simultaneous return to the *CAL.USER* menu.

calibr. PV - Calibration of the process actual value for input signal 4...20 mA:

- ▲ / ▼ Select *calibr. PV*.
-  Select **ENTER**. The menu options for the minimum and the maximum process actual value are displayed.
- ▲ / ▼ Select *PV 4 mA*. The minimum value for the input signal is displayed.
- Apply the minimum value to the input.
-  Select **OK**. Transfer and simultaneous return to the *calibr.PV* menu.
- ▲ / ▼ Select *PV 20mA*. The maximum value for the input signal is displayed.
- Apply the maximum value to the input.
-  Select **OK**. Transfer and simultaneous return to the *calibr.PV* menu.
-  Select **EXIT**. Acknowledgment and simultaneous return to the *CAL.USER* menu.






calibr. PV - Calibration of the process actual value for input signal Pt 100:


- ▲ / ▼ Select *calibr.PV*.
-  Select **ENTER**. The input screen for calibration of the temperature is opened.
- ▲ / ▼ <- Select decimal point and + select increase number.
Input the current temperature.

-  Select **OK**. Transfer and simultaneous return to the *CAL.USER* menu.
-  Select **EXIT**. Acknowledgment and simultaneous return to the main menu (MAIN).
-  Select **EXIT**. Switching from setting level ⇒ process level.
- ✔ You have calibrated *CAL.USER*.

16.1.17.3. Resetting the settings under *CAL.USER* to the factory settings

Reset the settings as follows:

-  Press **MENU** for 3 s. Switching from process level ⇒ setting level.
- ▲ / ▼ Select *CAL.USER*. (To do this, the auxiliary function must be incorporated into the main menu).
-  Select **ENTER**. The submenu options are displayed.
- ▲ / ▼ Select *copy FACT->USER*.
-  Hold down **RUN** as long as countdown (5 ...) is running.
The settings of *CAL.USER* are reset to the factory settings.
-  Select **EXIT**. Acknowledgment and simultaneous return to the main menu (MAIN).
-  Select **EXIT**. Switching from setting level ⇒ process level.
- ✔ You have reset the settings.




 The factory calibration is re-activated by deactivating *CAL.USER*, by removing the auxiliary function from the main menu (MAIN).

16.1.18 SET.FACTORY – Reset to factory settings

This function allows all settings implemented by the user to be reset to the delivery status.

All EEPROM parameters with the exception of the calibration values are reset to default values. Then a hardware reset is implemented.

Reset the settings to factory setting as follows:








-  Press **MENU** for 3 s. Switching from process level ⇒ setting level.
- ▲ / ▼ Select **SET.FACTORY**. (To do this, the auxiliary function must be incorporated into the main menu).
-  Press **RUN** for 3 s (until progress bar is closed) “factory reset” is shown. Reset is implemented.
-  Select **EXIT**. Switching from setting level ⇒ process level.
- ✔ You have reset the settings.



To adjust Type 8692, 8693 to the operating parameters, re-implement self-parameterization of the position controller (*X.TUNE*).

16.2 SERVICE.BUES – Setting the service interface

Set the service interface as follows:












-  Press **MENU** for 3 s. Switching from process level ⇒ setting level.
- ▲ / ▼ Select **SERVICE.BUES**.
-  Select **ENTER**. The possible *BUES* are displayed.
- ▲ / ▼ Select *baud rate*.
-  Select **ENTER**. The possible *baud rates* are displayed.
- ▲ / ▼ Select *baud rate*
 - 1000 kbit/s
 - 500 kbit/s
 - 250 kbit/s
 - 125 kbit/s
 - 50 kbit/s.
-  Select **SELECT**. The selected baud rate is now marked by a filled circle ●.
- ▲ / ▼ Select *address*.
-  Select **ENTER**. The possible *addresses* are displayed.
- ▲ / ▼ Select (0 - 127).
-  Select **SELECT**. The selected address is now marked by a filled circle ●.
-  Select **EXIT**. Switching from setting level ⇒ process level.
- ✔ You have set the service interface.

16.2.1 EXTRAS – Setting the display

This function can be used to individually set the display.

- In *DISP.ITEMS* the display of the process level can be individually set.
To do this, further menu options can be activated for the display of the process level. *POS* and *CMD* are activated in the as-delivered state.
- In *START-UP.ITEM* one of the activated menu options is specified as a start display after a restart.
- The type of display is selected via *DISP.MODE*.
normal = black font on light background.
inverse = white font on dark background.
- *DISP.LIGHT* is used to define the background lighting of the display.
on = Background lighting on.
off = Background lighting off.
user active = Background lighting switches off after 10 seconds with no user interaction. If a key is pressed again, the background lighting goes on again.

Activate the menu displays for displaying the process level as follows:

-  Press **MENU** for 3 s. Switching from process level ⇒ setting level.
 - ▲ / ▼ Select **ADD.FUNCTION**.
 -  Select **ENTER**. The possible auxiliary functions are displayed.
 - ▲ / ▼ Select **EXTRAS**.
 -  Select **ENTER**.
Activate the **EXTRAS** auxiliary function by checking the box and transfer into the main menu.
 -  Select **EXIT**. Return to the main menu (MAIN).
 - ▲ / ▼ Select **EXTRAS**.
 -  Select **ENTER**. The submenus of **EXTRAS** are displayed.
 - ▲ / ▼ Select **DIP.ITEMS**.
 -  Select **ENTER**.
The possible menu options are displayed.
POS, CMD, CMDIPOS, CMD/POS(t), CLOCK, INPUT, TEMP, X.TUNE.
Additionally for process controller Type 8693:
PV, SP, SPIPV, SP/PV(t), P.TUNE, P.LIN.
 - ▲ / ▼ Select required menu options.
 -  Select **SELEC**. Activate the selection by checking the box or deactivate it by unchecking the box .
 -  Select **EXIT**. Return to the **EXTRAS** menu.
 -  Select **EXIT**. Return to the main menu (MAIN).
 -  Select **EXIT**. Switching from setting level ⇒ process level.
-  You have activated the menu display.

The activated menu options are now displayed on the process level display.

Use the arrow keys \triangle ∇ to switch between the displays.



Each menu option which can be selected can also be deactivated so that it is not indicated on the process level display.
However, there must be at least one menu option available which can be indicated on the display.
If nothing was selected, the *POS* menu option is automatically activated.

START-UP.ITEM - Specifying menu option for the start display:

EXTRAS → **START-UP.ITEM** \triangle / ∇ Select menu option and specify with **SELEC**.


The menu option for the start display is marked by the filled circle \bullet .

The detailed procedure can be found in the extensive menu description for *DISP.ITEMS*. The *START-UP.ITEM* and *DISP.ITEMS* menus are set in the same way.


DISP.MODE - Select type of display

(black font on light background or white font on dark background):

Select the type of display as follows:

→  Press **MENU** for 3 s. Switching from process level \Rightarrow setting level.


→ \triangle / ∇ Select **ADD.FUNCTION**.

→  Select **ENTER**. The possible auxiliary functions are displayed.

→ \triangle / ∇ Select **EXTRAS**.

→  Select **ENTER**.

Activate the *EXTRAS* auxiliary function by checking the box and transfer into the main menu.

→  Select **EXIT**. Return to the main menu (MAIN).

→ \triangle / ∇ Select **DISP.MODE**.

→  Select **ENTER**.

The possible menu options for the type of display are shown.

normal = black font on light background

inverse = white font on dark background


→ \triangle / ∇ Select the type of display.


→  Select **SELEC**.

The selection is marked by a filled circle \bullet .

→  Select **EXIT**. Return to the *EXTRAS* menu.

→  Select **EXIT**. Return to the main menu (MAIN).

→  Select **EXIT**. Switching from setting level \Rightarrow process level.

 You have set the type of display.

DISP.LIGHT - Define background lighting for display:

EXTRAS → **DISP.LIGHT** ▲ / ▼ Select background lighting and specify with **SELEC**.

The menu option for the background lighting is marked by the filled circle ●.

on = Background lighting on.

off = Background lighting off.

user active = Background lighting switches off after 10 seconds with no user interaction. If a key is pressed again, the background lighting goes on again.

The detailed procedure can be found in the extensive menu description for *DISP.MODE*. The *DISP.LIGHT* and *DISP.MODE* menus are set in the same way.

16.2.2 SERVICE

This function is of no importance to the operator of Type 8692, 8693. It is for internal use only.

16.2.3 SIMULATION – Menu for simulation of set-point value, process and process valve

This function can be used to simulate set-point value, process and process valve independently of each other.



Restarting the device deactivates the simulation.

The settings of *SIGNAL.form*, *x.SIM* and *p.SIM* are reset to the factory setting.

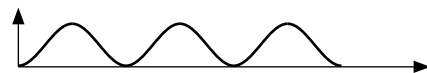
16.2.3.1 *SIGNAL.sim* – Simulation of the set-point value

The settings to simulate the set-point value are made in the *SIGNAL.sim* menu.

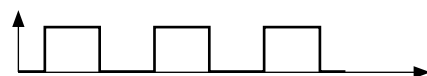
Activation of the simulation:

In the *SIGNAL.form* submenu by selecting one of the following waveforms

Sine wave Sine wave



Square Square wave



Triangle Triangle wave



Mixed

Single cycle of an alternating signal sequence.

Then the selection is set to *External* (set-point value simulation inactive).

The following parameters can be set for the selected waveform.

Menu option	Parameter setting	Schematic representation with sine wave
Offset	(Zero offset as %)	
Amplitude	(Amplitude as %)	
Periode	(Cycle duration in s)	

Table 33: SIGNAL.sim; parameter settings for set-point value simulation

Deactivation of the simulation: In the *SIGNAL.form* submenu

Selection **External** = set-point value simulation inactive
(corresponds to the factory setting in the as-delivered state)

Activate and parameterize the set-point value simulation as follows:

- Press **MENU** for 3 s. Switching from process level \Rightarrow setting level.
- $\blacktriangle / \blacktriangledown$ Select **SIMULATION**. (To do this, the auxiliary function must be incorporated into the main menu).
- Select **ENTER**. The submenu for setting the simulation is displayed.
- $\blacktriangle / \blacktriangledown$ Select **SIGNAL.sim**.
- Select **ENTER**.
The submenu for activating and parameterizing the set-point value simulation is displayed.
- Select $\blacktriangle / \blacktriangledown$ *required menu option*







Selection **External** = simulation inactive.

Selection **Sine wave** / **Square** / **Triangle** / **Mixed** = specify the waveform as well as activation of the simulation.

- Select **SELEC**. The selection is marked by a filled circle \bullet .
- **EXIT** Return to the *SIGNAL.sim* menu.

Setting the parameters for simulation of the set-point value:



- $\blacktriangle / \blacktriangledown$ Select **offset** (zero offset as %).
- Select **INPUT**. The input screen for specifying the offset is opened.

- ▲ / ▼ **+** Increase value
 <- Select decimal point and enter value.
-  Select **OK**. Transfer and simultaneous return to the *SIGNAL.sim* menu.
- ▲ / ▼ Select *amplitude* (amplitude as %).
-  Select **INPUT**. The input screen for specifying the amplitude is opened.
- ▲ / ▼ **+** Increase value
 <- Select decimal point and enter value.
-  Select **OK**. Transfer and simultaneous return to the *SIGNAL.sim* menu.
- ▲ / ▼ Select *period* (period duration in seconds).
-  Select **INPUT**. The input screen for specifying the cycle duration is opened.
- ▲ / ▼ **+** Increase value
 <- Select decimal point and enter value.
-  Select **OK**. Transfer and simultaneous return to the *SIGNAL.sim* menu.
-  Select **EXIT**. Return to the *SIMULATION* menu.

For simulation of process and process valve:

- ▲ / ▼ Select *CONTROL.sim*.
 For a description see chapter „[16.2.3.2. CONTROL.sim – Simulation of the process and process valve](#)“.

Leaving the *SIMULATION* menu:

-  Select **EXIT**. Return to the main menu (MAIN).
-  Select **EXIT**. Switching from setting level \Rightarrow process level.
- ✔ You have activated and parameterized the set-point value simulation.

16.2.3.2. CONTROL.sim – Simulation of the process and process valve

The settings to simulate the process and the process valve are made in the *CONTROL.sim* menu.

Settings

- Type of simulation: *x.SIM* Simulation of the process valve.
 p.SIM Simulation of the process.
- Parameterization of the process: *SIM.Gain* Specify amplification factor.
 SIM.Delay Specify time constant in seconds.

Example of a simulated process:

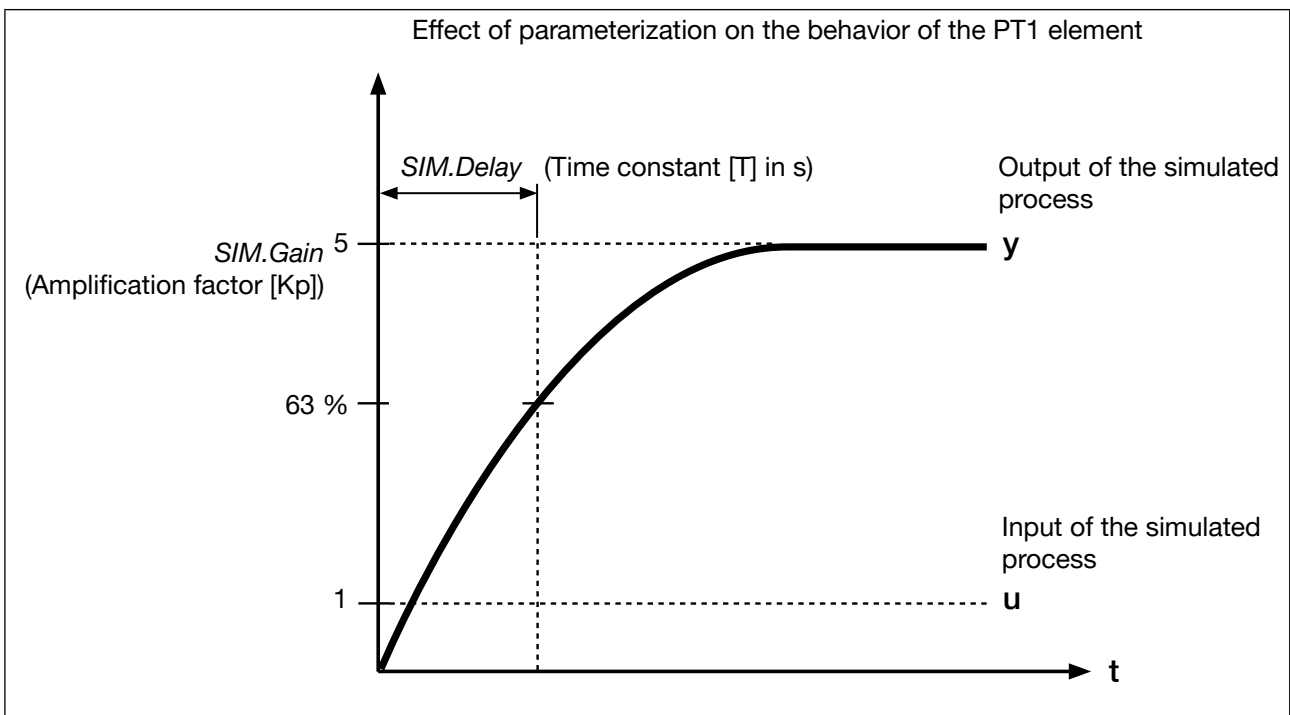



Figure 49: Example of a simulated process. Behavior of the PT1 element


Simulate the process and process valve as follows.

- Press **MENU** for 3 s. Switching from process level \Rightarrow setting level.
- Select *SIMULATION*. (To do this, the auxiliary function must be incorporated into the main menu).
- Select **ENTER**. The submenu for setting the simulation is displayed.
- Select *CONTROL.sim*.
- Select **ENTER**.
The submenu for activating and parameterizing the process and process valve simulation is displayed.
- Select required simulation.
Selection *x.SIM* = simulation process.
Selection *p.SIM* = simulation process valve.

→  Select **SELEC**. Activate the selection by checking the box or deactivate it by unchecking the box .

Setting the parameters for simulation of the process and/or the process valve:


→ ▲ / ▼ Select *SIM.Gain*. (Amplification factor).

→  Select **INPUT**. The input screen for specifying the amplification factor is opened.

→ ▲ / ▼ + Increase value
 <- Select decimal point and enter value.


→  Select **OK**. Transfer and simultaneous return to the *CONTROL.sim* menu.


→ ▲ / ▼ Select *SIM.Delay* (period duration in seconds).


→  Select **INPUT**. The input screen for specifying the cycle duration is opened.

→ ▲ / ▼ + Increase value
 <- Select decimal point and enter value.

→  Select **OK**. Transfer and simultaneous return to the *CONTROL.sim* menu.

→  Select **EXIT**. Return to the *SIMULATION* menu.

→  Select **EXIT**. Return to the main menu (MAIN).

→  Select **EXIT**. Switching from setting level ⇒ process level.

✔ You have simulated the process and process valve.

16.2.4 DIAGNOSE – Menu for monitoring valves (option)

The optional function *DIAGNOSE* can be used to monitor the state of the valve. If there are deviations from the set-point state, messages are output according to NE 107.

Example of the output of a diagnostic message:

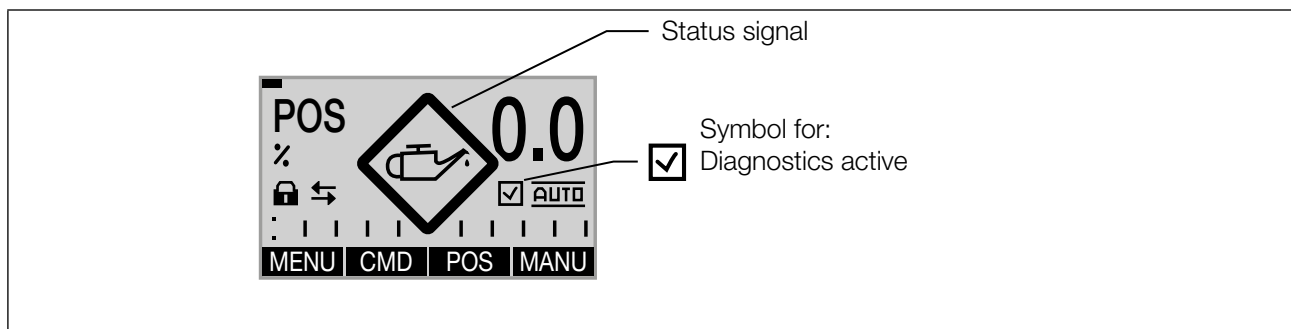



Figure 50: Example of a diagnostic message

16.2.4.1. Activation of the *DIAGNOSE* menu

To ensure that the *DIAGNOSE* menu can be set, it must first be activated in the main menu of the setting level (MAIN) via *ADD.FUNCTION*. See chapter „16.1 Activating and deactivating auxiliary functions“

 The active diagnostics is indicated on the display of the process level with a check mark . See Figure 50.

16.2.4.2. The *DIAGNOSE* main menu

The *DIAGNOSE* main menu consists of the following submenus.


	D.MSG	(Diagnostic messages) list of all diagnostic messages.
	CONFIG.MSG	Assignment of status signals for different diagnostic messages according to NE 107 (NE = NAMUR recommendation).
	ADD.DIAGNOSE	Activation of diagnostic functions by incorporation into the <i>DIAGNOSE</i> main menu.
	RESET.HISTORY	Deletion of the history entries of all diagnostic functions. The menu is only displayed if the <i>CLOCK</i> function has been selected on the process level.

Table 34: *DIAGNOSE*; main menu

The description can be found in Chapter „16.2.4.4. Description of the *DIAGNOSE* main menu“.

16.2.4.3. Activation of diagnostic functions

In the *ADD.DIAGNOSE* menu several diagnostic functions are activated and incorporated into the *DIAGNOSE* main menu.

Activatable diagnostic functions:

HISTOGRAM	Graphical display of the dwell time density and movement range.
SERVICE.TIME	Operating-hours counter
TRAVEL.ACCU	Path accumulator
CYCLE.COUNTER	Direction reversal counter
TEMP.CHECK	Temperature monitor
STROKE.CHECK	Monitoring of the mechanical end positions in the valve
PV.MONITOR	Process actual value monitoring (for Type 8693 only, process control)
POS.MONITOR	Position monitoring

Table 35: *ADD.DIAGNOSE*; overview of diagnostic functions

The exact description can be found in chapter „16.2.4.5. Description of the diagnostic functions“.

Activate the diagnostic functions as follows:

- Press **MENU** for 3 s. Switching from process level ⇒ setting level.
- ▲ / ▼ Select **DIAGNOSE**. (To do this, the **DIAGNOSE** auxiliary function must already have been activated by incorporation into the main menu (MAIN)).
- Select **ENTER**. The submenus are displayed.
- ▲ / ▼ Select **ADD.DIAGNOSE**.
- Select **ENTER**.
The other diagnostic functions are displayed.
- ▲ / ▼ Select required diagnostic function
- Select **ENTER**. The required diagnostic function is now marked by a cross ☒.

Either:

- ▲ / ▼ Select other diagnostic functions and select **ENTER**.
Keep repeating until all required diagnostic functions have been marked with a cross ☒.

Or:

- Select **EXIT**.
Acknowledgment and simultaneous return to the **DIAGNOSE** main menu.
The marked diagnostic functions have been activated and the setting menus are now in the **DIAGNOSE** main menu.

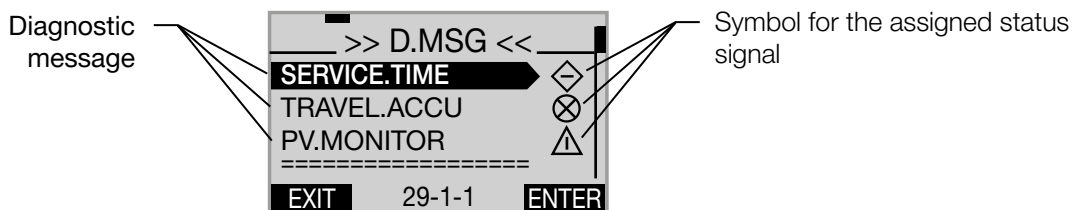
✔ You have activated the diagnostic functions.

16.2.4.4. Description of the *DIAGNOSE* main menu

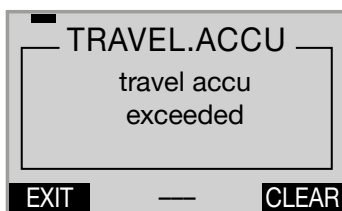
1. D.MSG – Diagnostic messages

All generated diagnostic messages are listed in the *D.MSG* menu where they can be viewed and deleted. The status signal, which is assigned to the diagnostic message, is indicated by a symbol.




Display example of a list with diagnostic messages





Display example of the description text of a diagnostic message



View and delete diagnostic messages as follows:

- ▲ / ▼ Select *D.MSG*.
-  Select **ENTER**. All generated diagnostic messages are displayed.
- ▲ / ▼ Select required message
-  Select **ENTER**.
Opening the diagnostic message. The description text is displayed (in English).
-  Select **EXIT**.
Closing the diagnostic message and return to *D.MSG*.


Or:

-  Hold down **CLEAR** as long as countdown (5 ...) is running.
Deleting the diagnostic message and return to *D.MSG*.
-  Select **EXIT**.
Return to the *DIAGNOSE* main menu.

 You have viewed and deleted the diagnostic functions.

2. **CONFIG.MSG** – Assignment of status signals according to NE 107 (NAMUR recommendation)

The status signals of the diagnostic messages can be changed in the *CONFIG.MSG* menu.

 The menu indicates only diagnostic functions which can output a message and which have already been activated in the *ADD.DIAGNOSE* menu.

The status signals have different priorities.

If several diagnostic messages are available with different status signals, the status signal with the highest priority is shown on the display.

Overview of the status signals according to NE 107 (NE = NAMUR recommendation):





Priority	1	2	3	4
Status signal				
Meaning	Failure	Function check	Out of specification	Maintenance required

Table 36: *CONFIG.MSG*; overview of status signals

The following status signals have been preset at the factory for the messages of the diagnostic functions:













Diagnostic function	Status signal according to NE 107	Signal miniature	Priority
<i>SERVICE.TIME</i>	Maintenance required		4
<i>TRAVEL.ACCU</i>	Maintenance required		4
<i>CYCLE.COUNTER</i>	Maintenance required		4
<i>TEMP.CHECK</i>	Out of specification		3
<i>STROKE.CHECK</i>	Out of specification		3
<i>PV.MONITOR</i>	Out of specification		3
<i>POS.MONITOR</i>	Out of specification		3

Table 37: *CONFIG.MSG*; factory setting (Default)

Assign the status signals as follows:

- ▲ / ▼ Select *CONFIG.MSG*.
-  Select **ENTER**. All activated diagnostic functions, which can output a message, are displayed.
- ▲ / ▼ Select required message.
-  Select **ENTER**.
The list of possible status signals is displayed.
- ▲ / ▼ Select required message.
-  Select **SELEC**.
The selected status signal is now marked by a filled circle ●.
-  Select **EXIT**. Acknowledgment and simultaneous return to the *CONFIG.MSG* menu.
The status signal is now assigned to the diagnostic function.
-  Select **EXIT**. Return to the *DIAGNOSE* main menu.
- ✔ You have assigned the status signals.

3. **ADD.DIAGNOSE** – Activation and deactivation of diagnostic functions

Diagnostic functions can be activated in this menu and incorporated into the *DIAGNOSE* main menu or already activated diagnostic functions can be deactivated again.

Activation of diagnostic functions:

For a description see chapter „16.2.4.3. Activation of diagnostic functions“.

Deactivation of diagnostic functions:

The procedure is the same as for activation. Only when the diagnostic functions are deactivated, is the cross after the diagnostic function removed again by pressing the **ENTER** key .

4. **RESET.HISTORY** – Deletion of the history entries of all diagnostic functions

Explanation of the history entries:

There is a history entry for each diagnostic message. This entry is assigned to the diagnostic function, which has actuated this message, and is saved there in the *HISTORY* submenu.



In the menu of some diagnostic functions there is a *HISTORY* submenu in which the history entries are saved.


RESET.HISTORY is used to delete the entries of all *HISTORY* submenus.


Individual entries can be deleted in the *HISTORY* submenu of the particular diagnostic function.

See chapter „16.2.4.6. History entries in the *HISTORY* submenu“.

Delete the history entries as follows:

→ ▲ / ▼ Select *RESET.HISTORY*.

→  Hold down **RUN** as long as countdown (5 ...) is running.
All history entries are deleted.

→  Select **EXIT**. Return to the *DIAGNOSE* main menu.

✔ You have deleted the history entries.



History entries are only created when the *CLOCK* function for the display has been activated on the process level.

Activating and setting *CLOCK* see chapter „13.6.1 Setting date and time“.

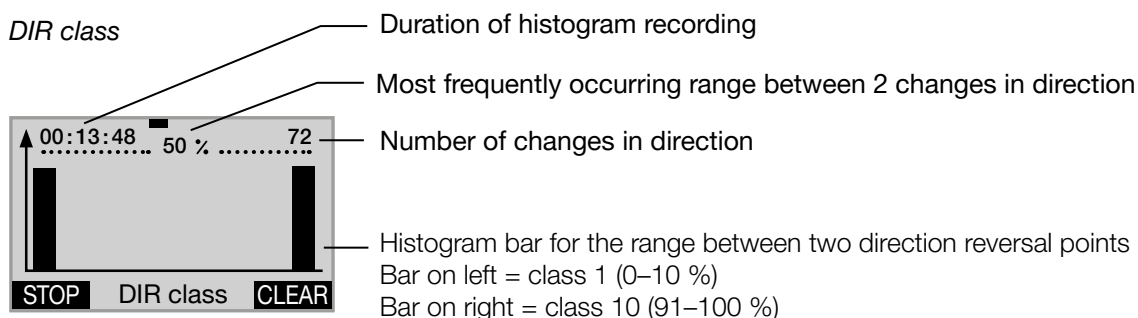
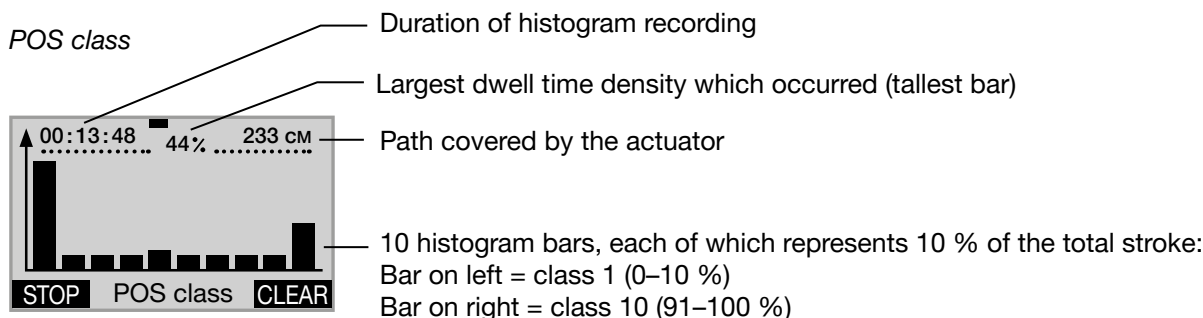
16.2.4.5. Description of the diagnostic functions

HISTOGRAM – Output of histograms

The *HISTOGRAM* menu is divided into 2 parts:

1. **Outputting the histograms for**
POS class (dwell time density) and
DIR class (movement range)
2. **List of the characteristic values for**
 CMD Set-point position valve actuator
 POS Actual position valve actuator
 DEV Deviation from POS to CMD
 TEMP Temperature
 SP Process set-point value
 PV Process actual value

Display description of the histograms:



POS class - Description of the histogram of the dwell time density

The histogram indicates how long the actuator has stopped in a specific position.

For this purpose the stroke range is divided into 10 classes.

The current position of one of the 10 classes is assigned to each scan time.

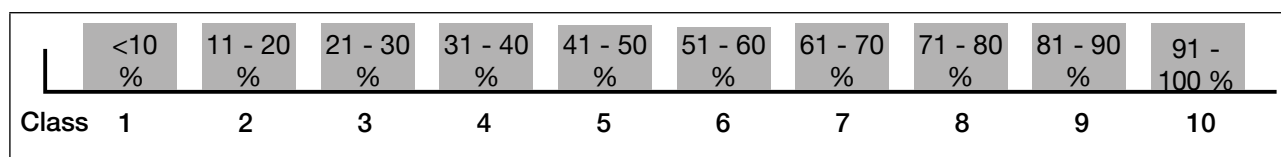


Figure 51: CMD class; position classes

Explanation of the histogram in the example

Sinusoidal progression of the actuator position:

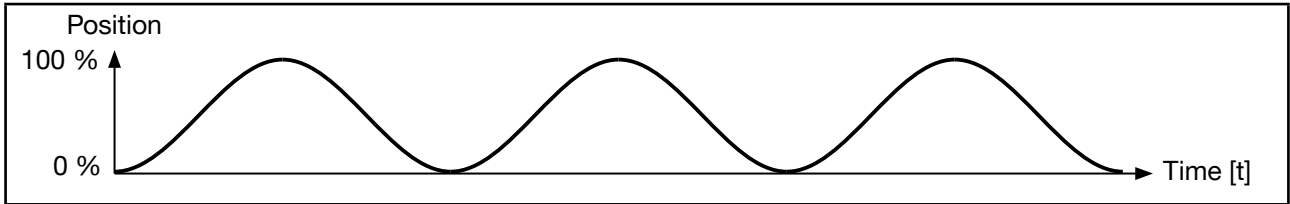


Figure 52: Sinusoidal progression of the actuator position

Histogram of the sinusoidal progression of the actuator position:

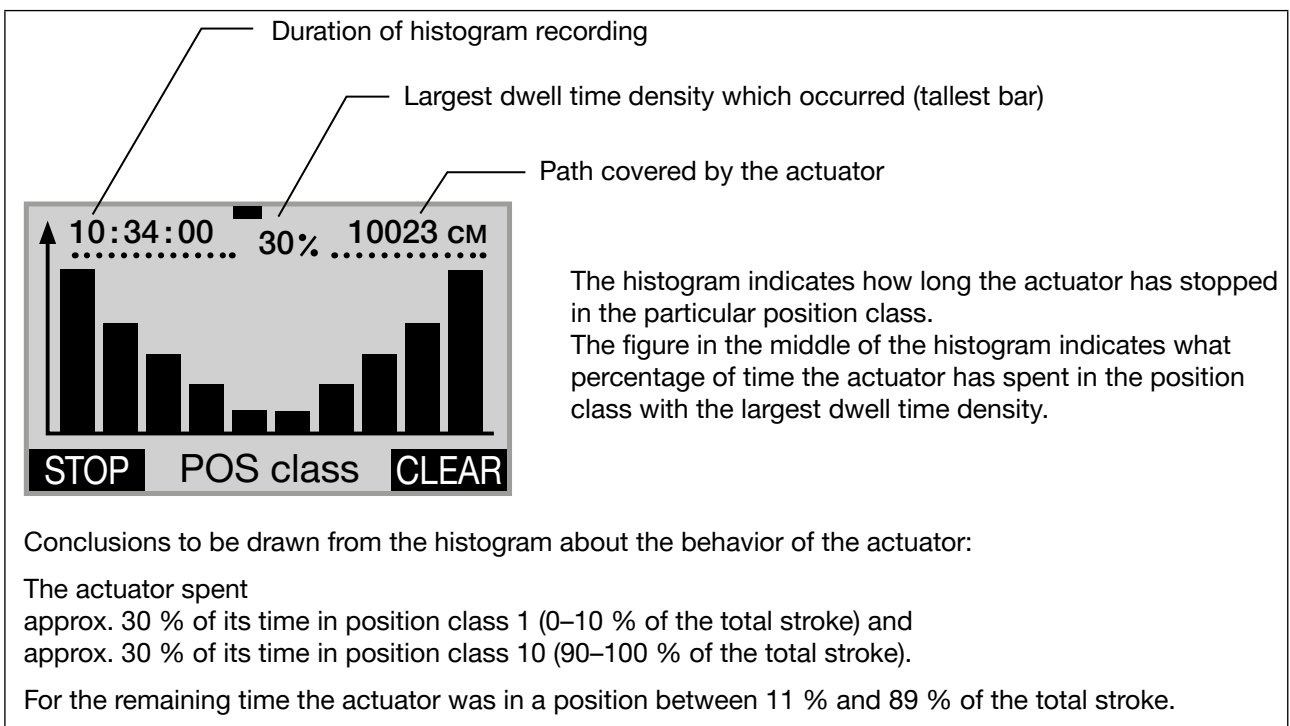


Figure 53: POS class; histogram of the dwell time density for sinusoidal progression of the actuator position



The distribution of the histogram allows conclusions to be drawn about the design of the control valve. E.g. if the actuator is in the lower stroke range only, the valve has probably been designed too large.

DIR class - Description of the histogram of the movement range

The histogram indicates the movement ranges of the actuator between two direction reversal points.

For this purpose the movement range between two changes in direction is divided into 10 classes.

The current position of one of the 10 classes is assigned to each scan time.

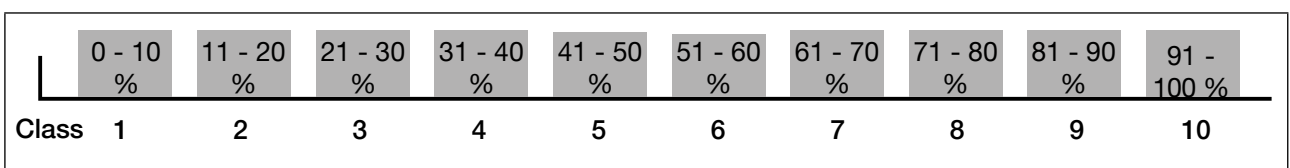


Figure 54: DIR class; change in direction classes

Explanation of the histogram in the example

Sinusoidal progression of the actuator position:

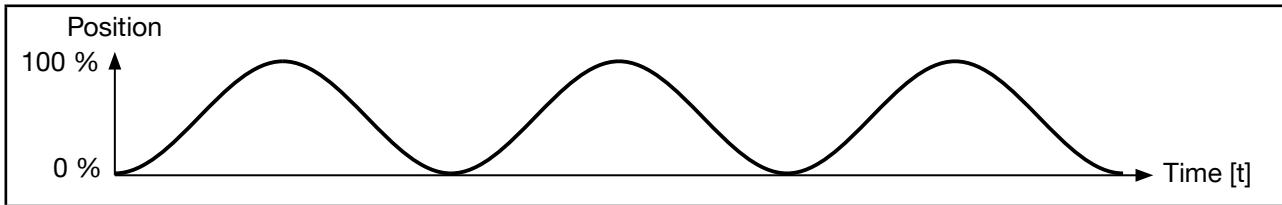


Figure 55: Sinusoidal progression of the actuator position

Histogram of the sinusoidal progression of the actuator position:

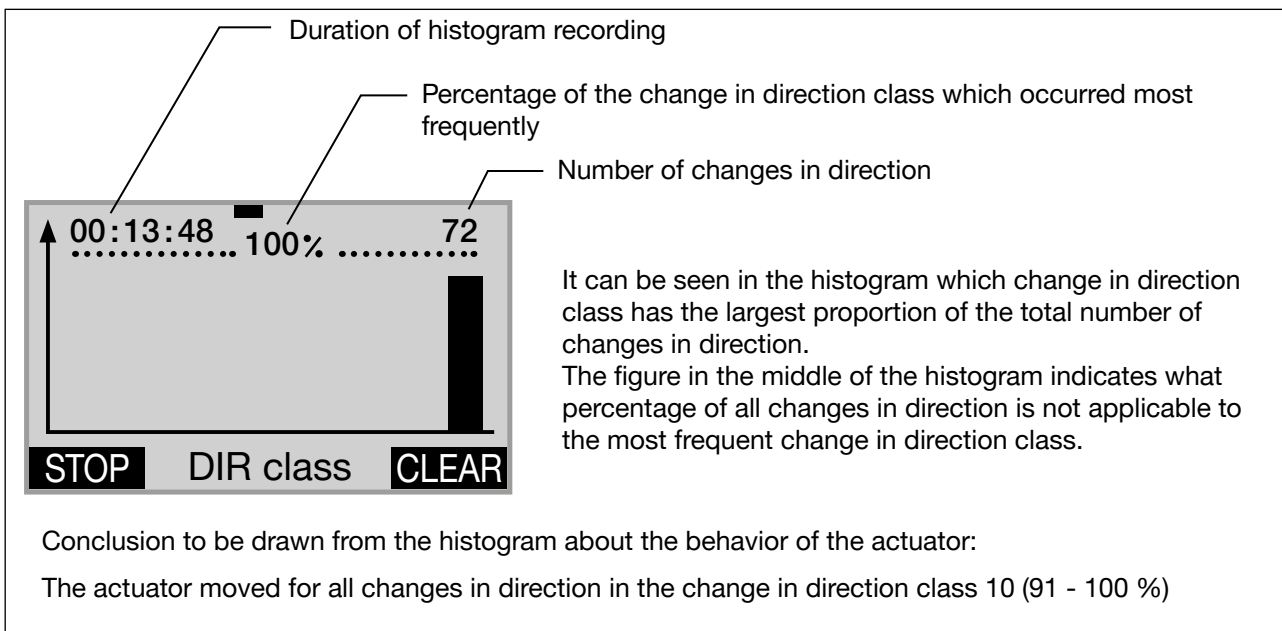


Figure 56: DIR class; histogram of the dwell time density for sinusoidal progression of the actuator position



! The histograms will only give correct information about the behavior of the actuator when the X.TUNE function required for the basic setting has been run.

Start, stop and delete the histograms as follows:



- ▲ / ▼ Select **HISTOGRAM**.
(To do this, the **HISTOGRAM** function must be incorporated into the **DIAGNOSE** main menu. See chapter „16.2.4.3. Activation of diagnostic functions“).
- 🗑️ Select **ENTER**. The empty matrix of the POS class submenu (dwell time density) is displayed.

Starting histograms:


Note: Diagnostics data are not saved persistently and will be lost when restarting the device.

-  Hold down **START*** as long as countdown (5 ...) is running.
Both histograms (*POS class* and *DIR class*) are started.
-  Change display view.
Selection options:
POS class (Histogram for the dwell time density),
DIR class (Histogram for the movement range),
SYSTEM DATA (list of the characteristic values).




Stopping histograms:

-  Hold down **STOP*** as long as countdown (5 ...) is running.
The recording of both histograms (*POS class* and *DIR class*) is stopped.
-  Change display view.
Selection options:
POS class (Histogram for the dwell time density),
DIR class (Histogram for the movement range),
SYSTEM DATA (list of the characteristic values).


Deleting histograms:

-  Hold down **CLEAR*** as long as countdown (5 ...) is running.
Both histograms (*POS class* and *DIR class*) are deleted.

Return to the *DIAGNOSE* main menu:

-  Select *SYSTEM-DATA*
-  Or  select **EXIT**. Return to the *DIAGNOSE* main menu.

* The key functions **START**, **STOP** and **CLEAR** are available only in the display views of the histograms *POS class* and *DIR class*.

 You have started, stopped and deleted the histograms.

SERVICE.TIME – Operating-hours counter

The operating-hours counter records the time during which the device was switched on.

If the duty cycle reaches the specified time limit, a message is generated.

- To do this, a history entry is made in the *HISTORY* submenu. For a description see „16.2.4.6. History entries in the *HISTORY* submenu“.
- The status signal, which is assigned to the message, is indicated at short intervals on the display.
See *D.MSG* and *CONFIG.MSG* in chapter 16.2.4.4.

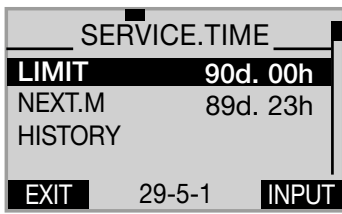
Display <i>SERVICE.TIME</i>	Description of the functions
	<p>The interval for messages preset at the factory for 90 days can be changed in the <i>LIMIT</i> submenu.</p> <p>After <i>NEXT.M</i> the remaining time is displayed until the next message appears.</p> <p>The history entries of the last 3 messages can be viewed and deleted in the <i>HISTORY</i> submenu.</p>

Table 38: *SERVICE.TIME*; operating-hours counter

MAN 1000327408 EN Version: N Status: RL (released | freigegeben) printed: 01.09.2023

Specify the interval for outputting messages as follows:

- ▲ / ▼ Select **SERVICE.TIME**.
(To do this, the *SERVICE.TIME* function must be incorporated into the *DIAGNOSE* main menu. See chapter „16.2.4.3. Activation of diagnostic functions“).
- Select **ENTER**. The menu is displayed.
- ▲ / ▼ Select **LIMIT**.
- Select **INPUT**. The preset value is displayed.
- ▲ / ▼ **+** Increase value
<- Changing the (time unit: d/h/m)
Setting interval for outputting the message.
- Select **OK**. Return to the *SERVICE.TIME* menu.
- Select **EXIT**. Return to the *DIAGNOSE* main menu.
- ✔ You have specified the interval for outputting messages.

TRAVEL.ACCU – Path accumulator

The path accumulator records and adds up the path which the actuator piston covers. A movement of the actuator piston is detected when the position changes by at least 1 %.






The interval for outputting messages is specified by inputting a limit for the total number of piston movements.

- To do this, a history entry is made in the *HISTORY* submenu. For a description see „16.2.4.6. History entries in the *HISTORY* submenu“.
- The status signal, which is assigned to the message, is indicated at short intervals on the display. See *D.MSG* and *CONFIG.MSG* in chapter 16.2.4.4.

Display <i>TRAVEL.ACCU</i>	Description of the functions
	<p>The <i>HUB</i> submenu specifies the total stroke of the actuator piston. The total stroke is automatically determined during the basic setting of the device (running <i>X.TUNE</i>).</p> <p>In the case of an analog position sensor, the total stroke must be input by pressing the INPUT key.</p> <p>The interval for outputting the message can be changed in the <i>LIMIT</i> submenu. A piston movement which covers 10 km has been preset at the factory.</p> <p>After <i>NEXT.M</i> the remaining piston movement distance is displayed until the next message appears.</p> <p>The history entries of the last 3 messages can be viewed and deleted in the <i>HISTORY</i> submenu.</p>

Table 39: *TRAVEL.ACCU*; path accumulator

Specify the interval for outputting messages as follows:

- ▲ / ▼ Select *TRAVEL.ACCU*.
(To do this, the *TRAVEL.ACCU* function must be incorporated into the *DIAGNOSE* main menu. See chapter „16.2.4.3. Activation of diagnostic functions“).
-  Select **ENTER**. The menu is displayed.
- * Required for analog position sensor only (setting the *HUB* submenu)
- ▲ / ▼ Select *HUB*.
-  Select **INPUT***. The preset value is displayed.
- ▲ / ▼ **+** Increase value
<- Changing the decimal point
Setting total stroke of the actuator piston.
- ▲ / ▼ Select *LIMIT*.
-  Select **INPUT***. The preset value is displayed.
- ▲ / ▼ **+** Increase value
<- Changing the decimal point
Setting interval for outputting the message (limit for sum of the piston movement).
-  Select **OK**. Return to the *TRAVEL.ACCU* menu.
-  Select **EXIT**. Return to the *DIAGNOSE* main menu.
- ✔ You have specified the interval for outputting messages.

CYCLE.COUNTER – Direction reversal counter

The direction reversal counter counts the number of changes in direction of the actuator piston. A change in direction is detected when the position of the actuator piston changes by at least 1 %.

The interval for outputting messages is specified by inputting a limit for the total number of changes in direction.

- To do this, a history entry is made in the *HISTORY* submenu. For a description see „16.2.4.6. History entries in the *HISTORY* submenu“.
- The status signal, which is assigned to the message, is indicated at short intervals on the display. See *D.MSG* and *CONFIG.MSG* in chapter 16.2.4.4.

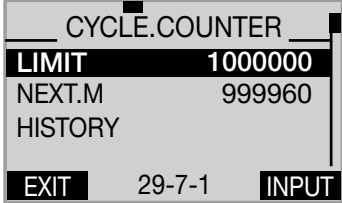
Display <i>CYCLE.COUNTER</i>	Description of the functions
	<p>The interval for outputting the message can be changed in the <i>LIMIT</i> submenu. 1 million changes in direction have been preset at the factory.</p> <p>After <i>NEXT.M</i> the remaining changes in direction are displayed until the next message appears.</p> <p>The history entries of the last 3 messages can be viewed and deleted in the <i>HISTORY</i> submenu.</p>

Table 40: *SERVICE.TIME*; operating-hours counter

Specify the interval for outputting messages as follows:

- ▲ / ▼ Select **CYCLE.COUNTER**.
(To do this, the **CYCLE.COUNTER** function must be incorporated into the **DIAGNOSE** main menu. See chapter „16.2.4.3. Activation of diagnostic functions“.)
- Select **ENTER**. The menu is displayed.
- ▲ / ▼ Select **LIMIT**.
- Select **INPUT**. The preset value is displayed.
- ▲ / ▼ **+** Increase value
<- Changing the decimal point
Setting interval for outputting the message (limited number of changes in direction).
- Select **OK**. Return to the **CYCLE.COUNTER** menu.
- Select **EXIT**. Return to the **DIAGNOSE** main menu.
- ✔ You have specified the interval for outputting messages.

TEMP.CHECK – Temperature monitor

The temperature monitor checks whether the current temperature* is within the specified temperature range. The temperature range is specified by inputting a minimum and maximum temperature. If the temperature deviates from the specified range, a message is output.

- To do this, a history entry is made in the **HISTORY** submenu. For a description see „16.2.4.6. History entries in the HISTORY submenu“.
- The status signal, which is assigned to the message, is indicated at short intervals on the display. See **D.MSG** and **CONFIG.MSG** in chapter „16.2.4.4. Description of the DIAGNOSE main menu“.

In addition to the monitor there is a temperature slave pointer. This indicates the lowest and highest of the measured temperature values. The slave pointer can be reset by pressing the **CLEAR** key.













Display TEMP.CHECK	Description of the functions
	<p>CURRENT indicates the current temperature*.</p> <p>MAX indicates the highest temperature of the slave pointer</p> <p>MIN indicates the lowest temperature of the slave pointer.</p> <p>The permitted temperature range can be changed in the LIMIT submenu. A message is output if the temperature exceeds or drops below the permitted range. The temperature range has been preset at the factory from 0...60 °C.</p>
	<p>The history entries of the last 3 messages can be viewed and deleted in the HISTORY submenu.</p>

Table 41: **TEMP.CHECK**; temperature range

*When selecting **LIMIT** values, make sure that the temperature displayed is influenced by the heating of the electronics assembly and by the heat radiation of hot valve components.

This must not be interpreted as an ambient temperature. Similar temperature values must therefore only be expected for comparable usage conditions.

Specify the temperature limit for outputting messages as follows:

- ▲ / ▼ Select *TEMP.CHECK*.
(To do this, the *TEMP.CHECK* function must be incorporated into the *DIAGNOSE* main menu.
See chapter „16.2.4.3. Activation of diagnostic functions“.
-  Select **ENTER**. The menu is displayed.
- ▲ / ▼ Select *LIMIT*.
-  Select **ENTER**.
The upper and lower temperature limit is displayed.
The upper limit *TEMP.MAX* has already been selected.
-  Select **INPUT**. Open input screen for upper temperature limit.
- ▲ / ▼  Increase value
 Changing the decimal point
Input upper temperature limit *TEMP.MAX*.
-  Select **OK**. Acknowledge value.
- ▲ / ▼ Select *TEMP.MIN*.
-  Select **INPUT**. Open factory setting for lower temperature limit.
- ▲ / ▼  Increase value
 Changing the decimal point
Input lower temperature limit *TEMP.MIN*.
-  Select **OK**. Acknowledge value.
-  Select **EXIT**. Return to the *TEMP.CHECK* menu.
-  Select **EXIT**. Return to the *DIAGNOSE* main menu.
- ✔ You have specified the temperature limit for outputting messages.

STROKE.CHECK – End position monitor

The *STROKE.CHECK* function is used to monitor the physical end positions of the valve. In this way wear marks can be detected on the valve seat.

To do this, a tolerance band is specified for the lower end position (position 0 %) and for the upper end position (position 100 %). If an end position exceeds or falls below the tolerance band, a message is output.

- To do this, a history entry is made in the *HISTORY* submenu. For a description see „16.2.4.6. History entries in the *HISTORY* submenu“.
- The status signal, which is assigned to the message, is indicated at short intervals on the display.
See *D.MSG* and *CONFIG.MSG* in chapter 16.2.4.4.

In addition to the monitor there is an end position slave pointer. This indicates the minimum and maximum position of the determined end positions. The slave pointer can be reset by pressing the **CLEAR** key.

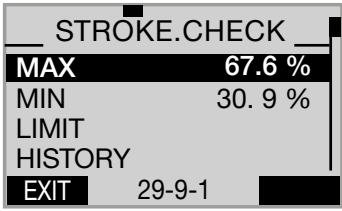







Display <i>STROKE.CHECK</i>	Description of the functions
	<p><i>MAX</i> indicates the maximum position of the slave pointer</p> <p><i>MIN</i> indicates the minimum position of the slave pointer.</p> <p>The tolerance band for the physical end positions can be set in the <i>LIMIT</i> submenu. A message is output if the temperature exceeds or drops below the permitted range.</p> <p>Example: Input upper end position <i>TOL MAX</i> = 1 % If the position is less than -1 %, a message is output</p> <p>Input lower end position <i>TOL ZERO</i> = 1 % If the position is greater than 101 %, a message is output</p> <p>The history entries of the last 3 messages can be viewed and deleted in the <i>HISTORY</i> submenu.</p>


Table 42: *STROKE.CHECK*; end position monitor

If a stroke limit was set in the *X.LIMIT* menu, the mechanical end position monitor has only limited relevance.

The end positions indicated on the process level under *POS* are not the physically caused end positions in this case. Therefore they cannot be compared with the end positions indicated in the *STROKE.CHECK* menu under *MIN* and *MAX*.

Specify the position limit for outputting messages as follows:

- ▲ / ▼ Select *STROKE.CHECK*.
(To do this, the *STROKE.CHECK* function must be incorporated into the *DIAGNOSE* main menu. See chapter „16.2.4.3. Activation of diagnostic functions“).
-  Select **ENTER**. The menus are displayed.
- ▲ / ▼ Select *LIMIT*.
-  Select **ENTER**.
The submenus for inputting the lower and upper end position tolerance are displayed.
The submenu for inputting the lower end position tolerance *ZERO.TOL* has already been selected.
-  Select **INPUT**. Open input screen for lower end position tolerance.
- ▲ / ▼ **+** Increase value
<- Changing the decimal point
Input lower end position tolerance *ZERO.TOL*.
-  Select **OK**. Acknowledge value.
- ▲ / ▼ Select *MAX.TOL*.
-  Select **INPUT**. Open input screen for lower end position tolerance.
- ▲ / ▼ **+** Increase value
<- Changing the decimal point
Input upper end position tolerance *MAX.TOL*.
-  Select **OK**. Acknowledge value.
-  Select **EXIT**. Return to the *STROKE.CHECK* menu.

→  Select **EXIT**. Return to the *DIAGNOSE* main menu.

✔ You have specified the position limit for outputting messages.

POS.MONITOR –Position monitor

The *POS.MONITOR* function monitors the current position of the actuator.

The tolerance band for the set-point value is specified in the *DEADBAND* submenu.

A period for alignment of the actual value with the set-point value is specified in the *COMP.TIME* submenu (compensation time).

The compensation time *COMP.TIME* starts recording as soon as the set-point value is constant. When the compensation time has elapsed, monitoring starts.

If the control deviation (*DEV*) of the actual value is greater than the tolerance band of the set-point value during monitoring, a message is output.

- To do this, a history entry is made in the *HISTORY* submenu. For a description see „16.2.4.6. History entries in the *HISTORY* submenu“.
- The status signal, which is assigned to the message, is indicated at short intervals on the display. See *D.MSG* and *CONFIG.MSG* in chapter 16.2.4.4.

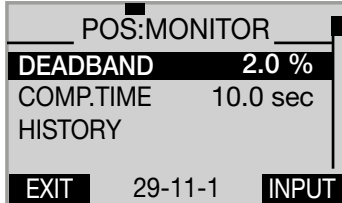
Display <i>POS.MONITOR</i>	Description of the functions
	<p>The tolerance band of the set-point value preset at the factory to 2 % can be changed in the <i>DEADBAND</i> submenu.</p> <p>The compensation time is set in <i>COMP.TIME</i> (compensation time).</p> <p>The history entries of the last 3 messages can be viewed and deleted in the <i>HISTORY</i> submenu.</p>

Table 43: *POS.MONITOR*; position monitor

Schematic representation

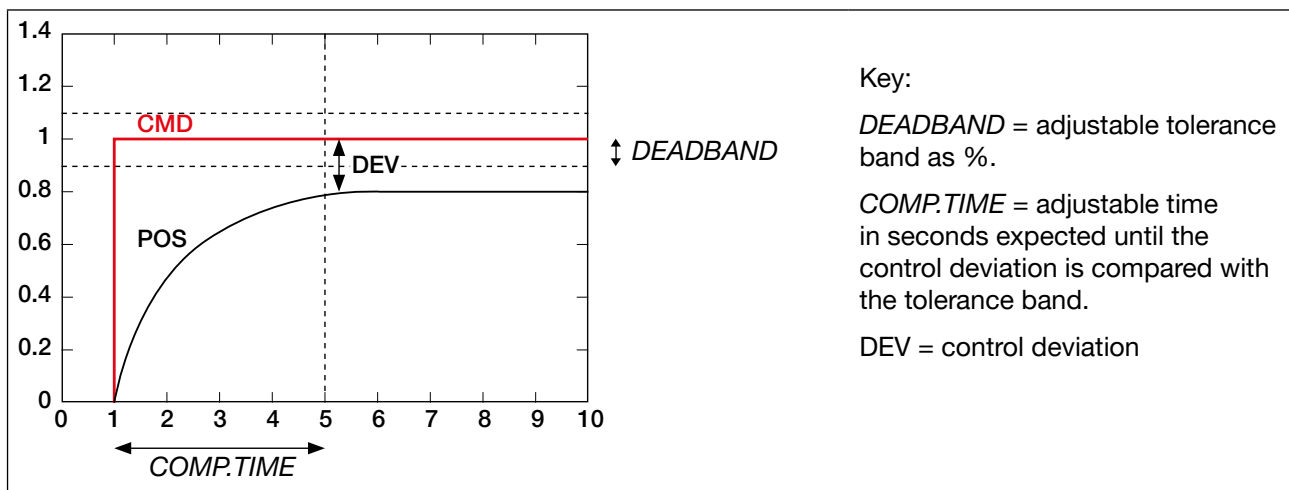








Figure 57: *POS.MONITOR*; schematic representation of position monitor

Set the tolerance band and the compensation time as follows:

- ▲ / ▼ Select *POS.MONITOR*.
(To do this, the *POS.MONITOR* function must be incorporated into the *DIAGNOSE* main menu. See chapter „16.2.4.3. Activation of diagnostic functions“).
-  Select **ENTER**. The menu is displayed. *DEADBAND* has already been selected.
-  Select **INPUT**. The preset value is displayed.
- ▲ / ▼ **+** Increase value
<- Changing the decimal point
Input tolerance band.
-  Select **OK**. Acknowledge value.
- ▲ / ▼ Select *COMP.TIME*.
-  Select **INPUT**. The preset value is displayed.
- ▲ / ▼ **+** Increase value
<- Changing the decimal point
Input compensation time.
-  Select **OK**. Return to the *POS.MONITOR* menu.
-  Select **EXIT**. Return to the *DIAGNOSE* main menu.
- ✔ You have specified the tolerance band and the compensation time.

PV.MONITOR – Process monitor (for Type 8693 only)

The *PV.MONITOR* function monitors the process actual value.

The operating menu is identical to the position monitor *POS.MONITOR* described above. In contrast, it is not the position of the actuator which is monitored here but the process.

16.2.4.6. History entries in the HISTORY submenu

Each diagnostic function, which can output a message, has the *HISTORY* submenu.

When the diagnostic message is actuated, a history entry is created with date and value. The history entries of the respective diagnostic function can be viewed and deleted in the *HISTORY* submenu.

A maximum of three history entries are stored from each diagnostic message. If three history entries are already available when a message is actuated, the oldest history entry is deleted.

Example: History of the diagnostic function *TRAVEL.ACCU*

TRAVEL.ACCU	
DATE	VALUE
01.02.12	5 cm
01.02.12	35 cm
01.02.12	10 cm
EXIT	CLEAR

Description:

On the left of the display is the date and on the right the associated value.

Deleting the history:

Hold down the **CLEAR** key until the countdown (5...) is running.



The *RESET.HISTORY* diagnostic menu can be used to jointly delete the histories of all diagnostic functions. See chapter [16.2.4.4](#).

Delete the histories of a diagnostic function (example *TRAVEL.ACCU*) as follows:

- ▲ / ▼ Select *TRAVEL.ACCU*.
- Select **ENTER**. The menu is displayed.
- ▲ / ▼ Select *HISTORY*.
- Select **INPUT**. History entries with date and value are displayed.
- Hold down **CLEAR** as long as countdown (5 ...) is running.
The histories of the *TRAVEL.ACCU* diagnostic function are deleted.
- Select **EXIT**. Return to the *TRAVEL.ACCU* menu.
- Select **EXIT**. Return to the *DIAGNOSE* main menu.
- ✔ You have deleted the histories of the diagnostic function.



History entries are only created when the *CLOCK* function for the display has been activated on the process level.

To receive correct history entries, date and time must be correct.

Date and time must be reset after a restart. Therefore, the device switches immediately and automatically to the corresponding menu after a restart.

Activating and setting *CLOCK* see chapter [13.6.1](#).

16.3 Manual configuration of X.TUNE




This function is required for special requirements only.
 For standard applications the X.TUNE function has been preset at the factory.
 See chapter „14.3 X.TUNE – Automatic adjustment of the position controller“.

For special requirements the X.TUNE function, as described below, can be manually configured.

Open the menu for the manual configuration of X.TUNE as follows:

→  Press **MENU** for 3 s. Switching from process level ⇒ setting level.

→ ▲ / ▼ Select X.TUNE.

→  Select **RUN**. Opening the *Manual.TUNE* menu. The menu options for the manual configuration of X.TUNE are displayed.

✔ You have opened the menu for the manual configuration of X.TUNE.




16.3.1 Description of the menu for the manual configuration of X.TUNE

X.TUNE.CONFIG	Configuration of the X.TUNE function	Specify which functions are to be executed when X.TUNE is running (automatic self-optimization).
M.TUNE.POS	Position of the end positions	<ul style="list-style-type: none"> - Specify whether the pneumatic actuator has mechanical end positions. - Manual specification of the end positions If there are no mechanical end positions available, these are not approached by the X.TUNE and must be manually specified.
M.TUNE.PWM	Optimization of the PWM signals	Manual optimization of the PWM signals for control of the aeration valves and bleed valves. For optimization the valves must be aerated and bled. A progress bar on the display indicates the speed at which the valve is aerated or bled. The setting is optimum when the progress bar moves as slowly as possible.
M.TUNE.AIR	Determination of the opening and closing times of the actuator	Continuous determination of the opening and closing times of the actuator.

16.3.1.1. X.TUNE.CONFIG – Configuration of the X.TUNE function

In this menu you can specify which functions are to be executed when the X.TUNE function is running automatically.


Specify the functions in X.TUNE.CONFIG as follows:

- ▲ / ▼ Select X.TUNE.CONFIG.
-  Select **ENTER**.
The functions for automatic self-parameterization by X.TUNE are displayed.
- ▲ / ▼ Select required function.
-  Select **SELEC**. Activate the function by checking the box .
- Select required functions in succession using the arrow keys ▲ / ▼ and activate by checking the box .
-  Select **EXIT**. Return to the *Manual.TUNE menu*.
- ✔ You have specified the functions in X.TUNE.CONFIG.



16.3.1.2. X.TUNE.POS – Setting of the end positions

In this menu you can specify whether the pneumatic actuator has mechanical end positions or not. If there are no mechanical end positions available, these are not approached by the X.TUNE and must be manually specified.




Set the end position as follows:





- ▲ / ▼ Select M.TUNE.POS.
-  Select **ENTER**.
The selection for
ACT.limit = mechanical end positions available
ACT.nolimit = mechanical end positions not available is displayed.

If mechanical end positions are available

- ▲ / ▼ Select ACT.limit.
-  Select **SELEC**. The selection is marked by a filled circle ●.
-  Select **EXIT**. Return to the *Manual.TUNE menu*.

If mechanical end positions are not available

- ▲ / ▼ Select ACT.nolimit.
-  Select **SELEC**. The CAL.POS submenu for inputting the end positions is opened.
- ▲ / ▼ Select POS.pMIN.
-  Select **INPUT**. The input screen for the value of the lower end position is opened.
- ▲ / ▼ **OPN** Increase value
CLS Changing the decimal point
Approach lower end position of the valve.
-  Select **OK**. Transfer and simultaneous return to the CAL.POS menu.
- ▲ / ▼ Select POS.pMAX.

-  Select **INPUT**. The input screen for the value of the upper end position is opened.
- ▲ / ▼ **OPN** Increase value
CLS Changing the decimal point
 Approach upper end position of the valve.
-  Select **OK**. Transfer and simultaneous return to the *CAL.POS* menu.
-  Select **EXIT**. Return to the *M.TUNE.POS.* menu.
-  Select **EXIT**. Return to the *Manual.TUNE* menu.
- ✔ You have set the end position.

16.3.1.3. M.TUNE.PWM – Optimization of the PWM signals

In this menu the PWM signals for control of the aeration valves and bleed valves are manually optimized.

For optimization the actuator is aerated and bled. A progress bar on the display indicates the position of the actuator and the speed of aeration and deaeration.

The setting is optimum when the progress bar moves as slowly as possible.







WARNING!

Danger due to uncontrolled valve movement when the *M.TUNE.PWM* function is running.

When the *M.TUNE.PWM* function is running under operating pressure, there is an acute risk of injury.

- ▶ Never run *X.TUNE.PWM* while a process is running.
- ▶ Secure system against unintentional activation.

Optimize the PWM signals as follows:


- ▲ / ▼ Select *M.TUNE.PWM*.
-  Select **ENTER**.
 The submenu is displayed.
yB.min = aeration valve
yE.min = bleed valve
- ▲ / ▼ Select *yB.min*. Submenu for setting the PWM signal for the aeration valve.
-  Select **ENTER**. The input screen for setting the PWM signal is opened.
 The progress bar indicates the speed of aeration.
- ▲ / ▼ **+** Increase speed
- Reduce speed
 Minimize speed so that the progress bar moves as slowly as possible from left to right.
Note! Do not minimize speed to such an extent that the progress bar remains in one position.
-  Select **OK**. Transfer and simultaneous return to the *M.TUNE.PWM* menu.
- ▲ / ▼ Select *yE.min*. Submenu for setting the PWM signal for the bleed valve.
-  Select **ENTER**. The input screen for setting the PWM signal is opened.
 The progress bar indicates the speed of deaeration.

- ▲ / ▼ **+** Increase speed
- Reduce speed

Minimize speed so that the progress bar moves as slowly as possible from right to left.

Note! Do not minimize speed to such an extent that the progress bar remains in one position.

-  Select **OK**. Transfer and simultaneous return to the *M.TUNE.PWM* menu.

-  Select **EXIT**. Return to the *Manual.TUNE* menu.

- ✔ You have optimized the PWM signal.

16.3.1.4. M.TUNE.AIR – Determination of the opening and closing times


By running this function, the opening and closing times of the valve are determined continuously.

A change to the supply pressure will affect the aeration time which can be optimized in this way.

For the setting the effects, which a change to the supply pressure has on the aeration time, can be continuously monitored via the *M.TUNE.AIR* function.


Continuously determine the opening and closing times as follows:


- Select ▲ / ▼ *M.TUNE.AIR*.

-  Hold down **RUN** as long as countdown (5 ...) is running.
The aeration and deaeration times are displayed.
time.open = aeration
time.close = deaeration

Change the supply pressure to adjust the aeration time.
The changed aeration time is displayed continuously.

-  Select **EXIT**. Return to the *Manual.TUNE* menu.

-  Select **EXIT**. Return to the main menu (MAIN).

-  Select **EXIT**. Switching from setting level ⇒ process level.

- ✔ You have continuously determined the opening and closing times.

17 ACCESS TO THE BÜS SERVICE INTERFACE

The bÜS service interface is located inside the device.

→ It can be accessed by removing the housing jacket (with transparent cap).

→ Ensure that a terminating resistor is used.

NOTE!

Connect the bÜS service interface to the PC always via the USB-bÜS-interface set.

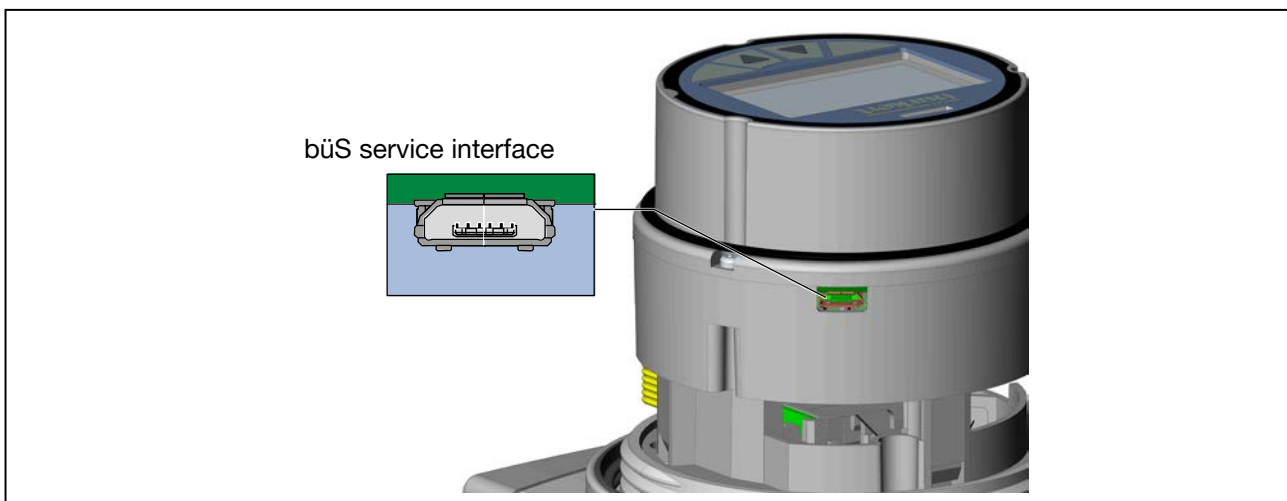


Figure 58: bÜS service interface

→ Connect device to PC.

→ Configure settings (see chapter „17.1 Setting options for start-up via Bürkert Communicator“).

→ Disconnect device from PC and install body casing.

Installing housing jacket

→ Check that the seal is correctly positioned on the housing jacket.

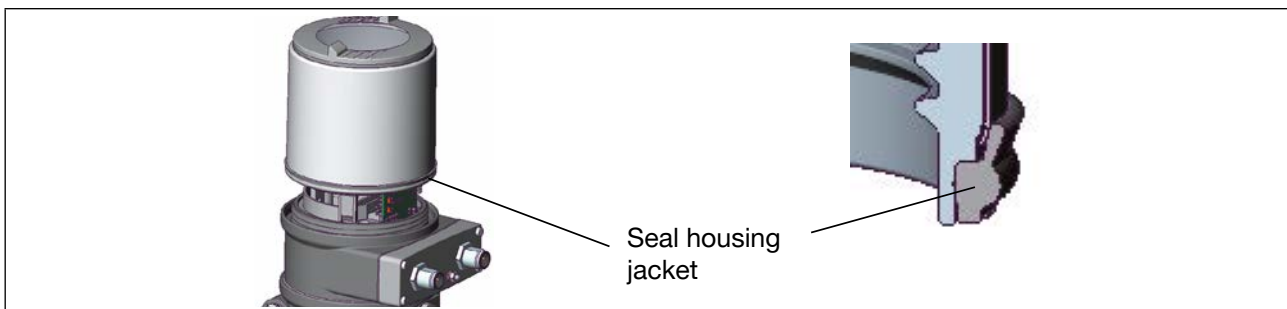


Figure 59: Position seal housing jacket

NOTE

Breakage of the pneumatic connection pieces due to rotational impact.

- ▶ When inserting the housing jacket, do not hold the actuator but the electrical connection housing above.

→ Place the housing jacket over the electronics module (and the display) and screw it in all the way; while doing so, hold the electrical connection housing (screwdriver available via the Bürkert Sales Center. Order number 674077).

NOTE

Malfunction due to ingress of dirt and moisture.

- ▶ To comply with the degree of protection IP65/IP67, ensure that the housing jacket and the electrical connection housing are screwed together tightly.

17.1 Setting options for start-up via Bürkert Communicator

- Setting with the Bürkert Communicator PC software on the PC

This type of setting is possible for all device types and device variants.

To do this, the device must be connected using the USB-büS-Interface sets and the büS service interface.



The PC software Bürkert Communicator can be downloaded free of charge from the Bürkert homepage.

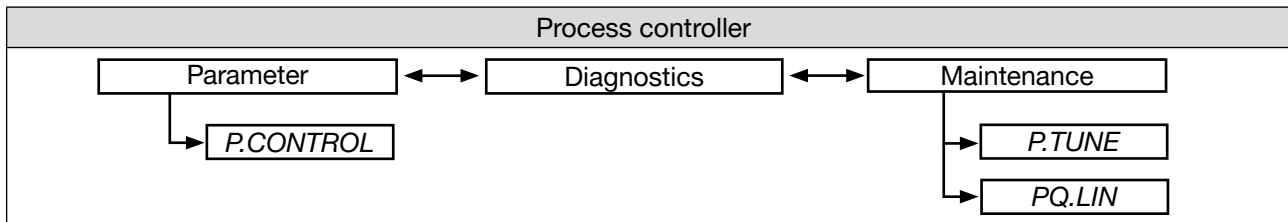


Table 44: Process controller level

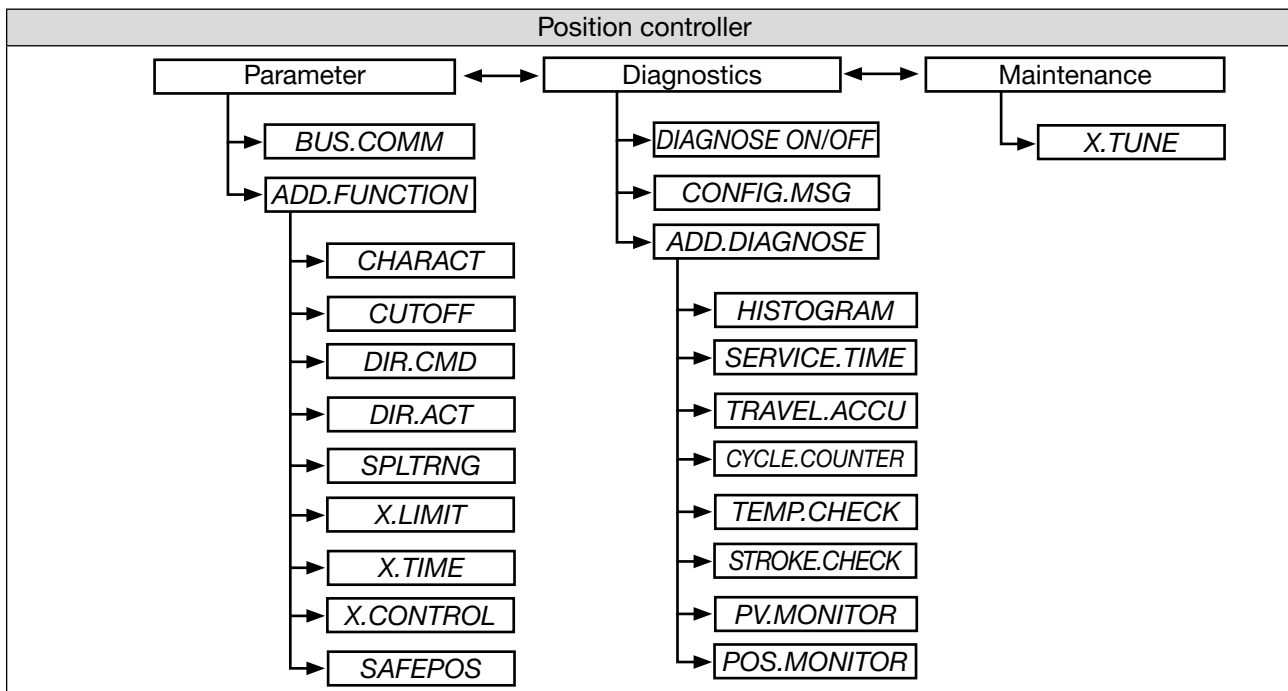


Table 45: Position controller level

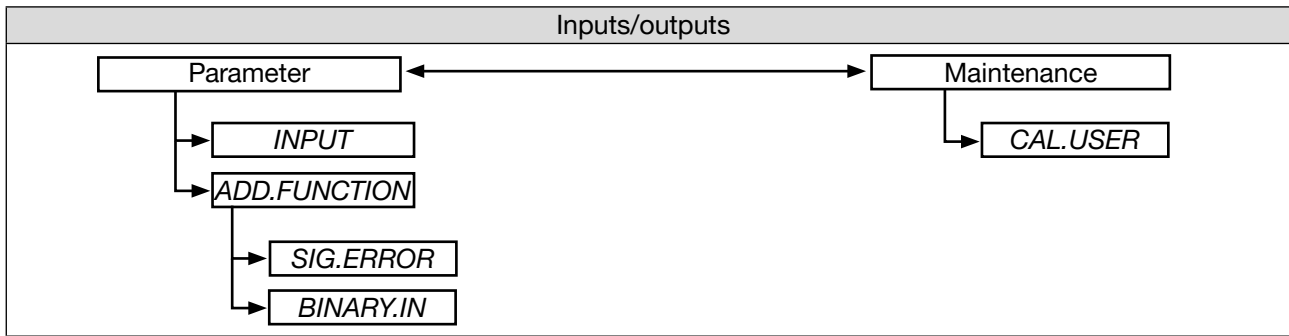


Table 46: Inputs/outputs level

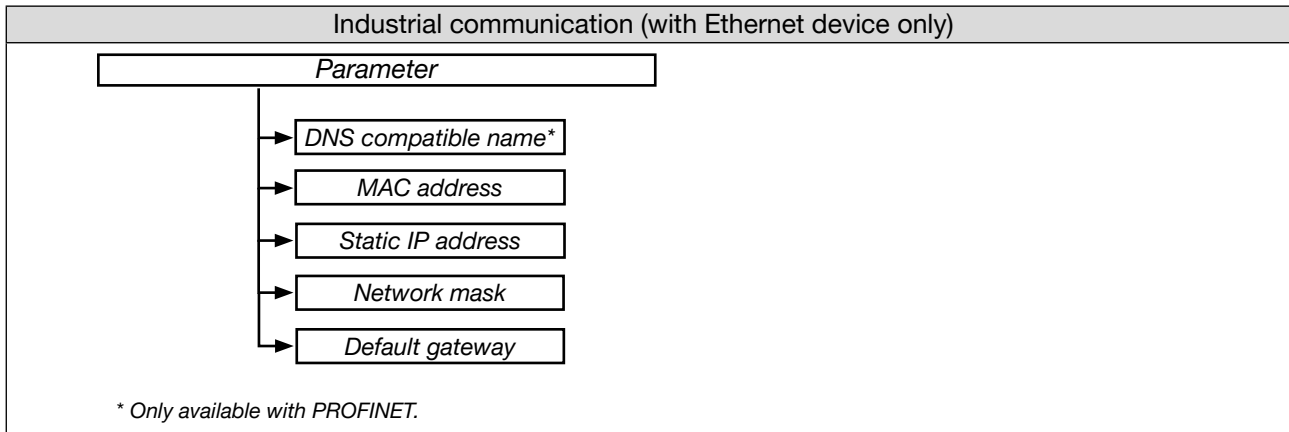


Table 47: Industrial communication level

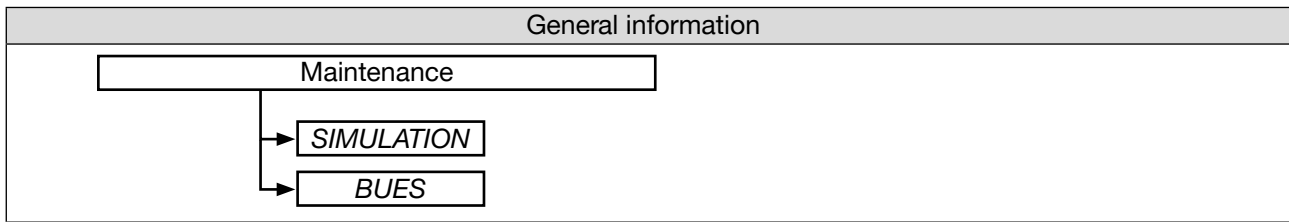


Table 48: General information level

MAN 1000327408 EN Version: N Status: RL (released | freigegeben) printed: 01.09.2023

18 OPERATING STRUCTURE AND FACTORY SETTING

The factory presets are highlighted in blue to the right of the menu in the operating structure. Examples:

<input checked="" type="radio"/> / <input checked="" type="checkbox"/>	Menu options activated or selected at the factory
<input type="radio"/> / <input type="checkbox"/>	Menu options not activated or selected at the factory
2 %, 10 sec, ...	Values set at the factory

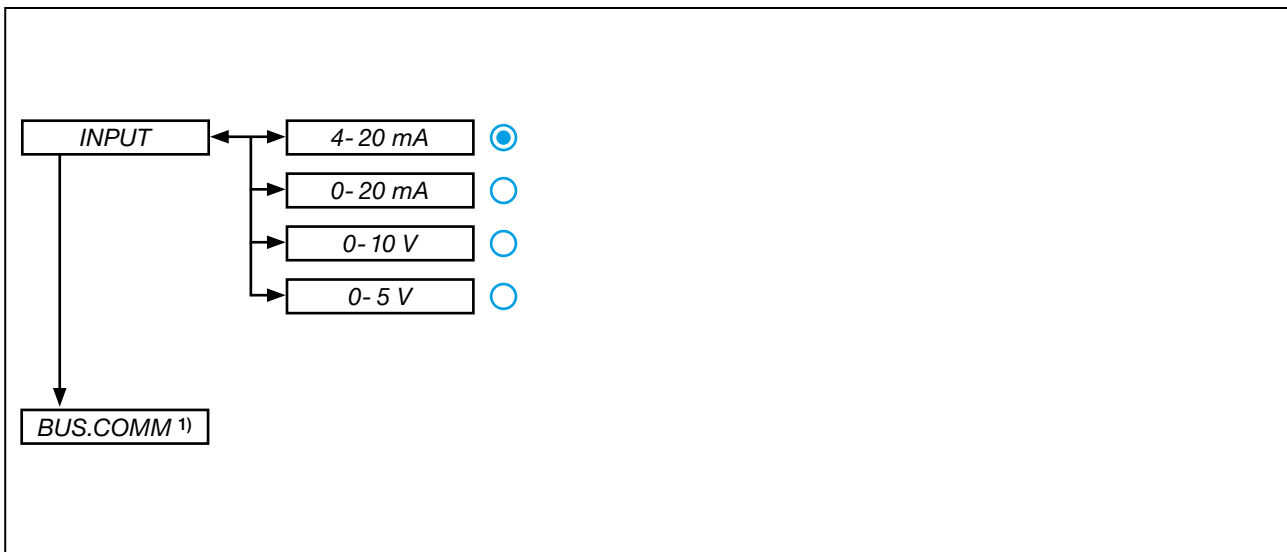


Figure 60: Operating structure - 1

3) Only for field bus

MAN 1000327408 EN Version: N Status: RL (released | freigegeben) printed: 01.09.2023

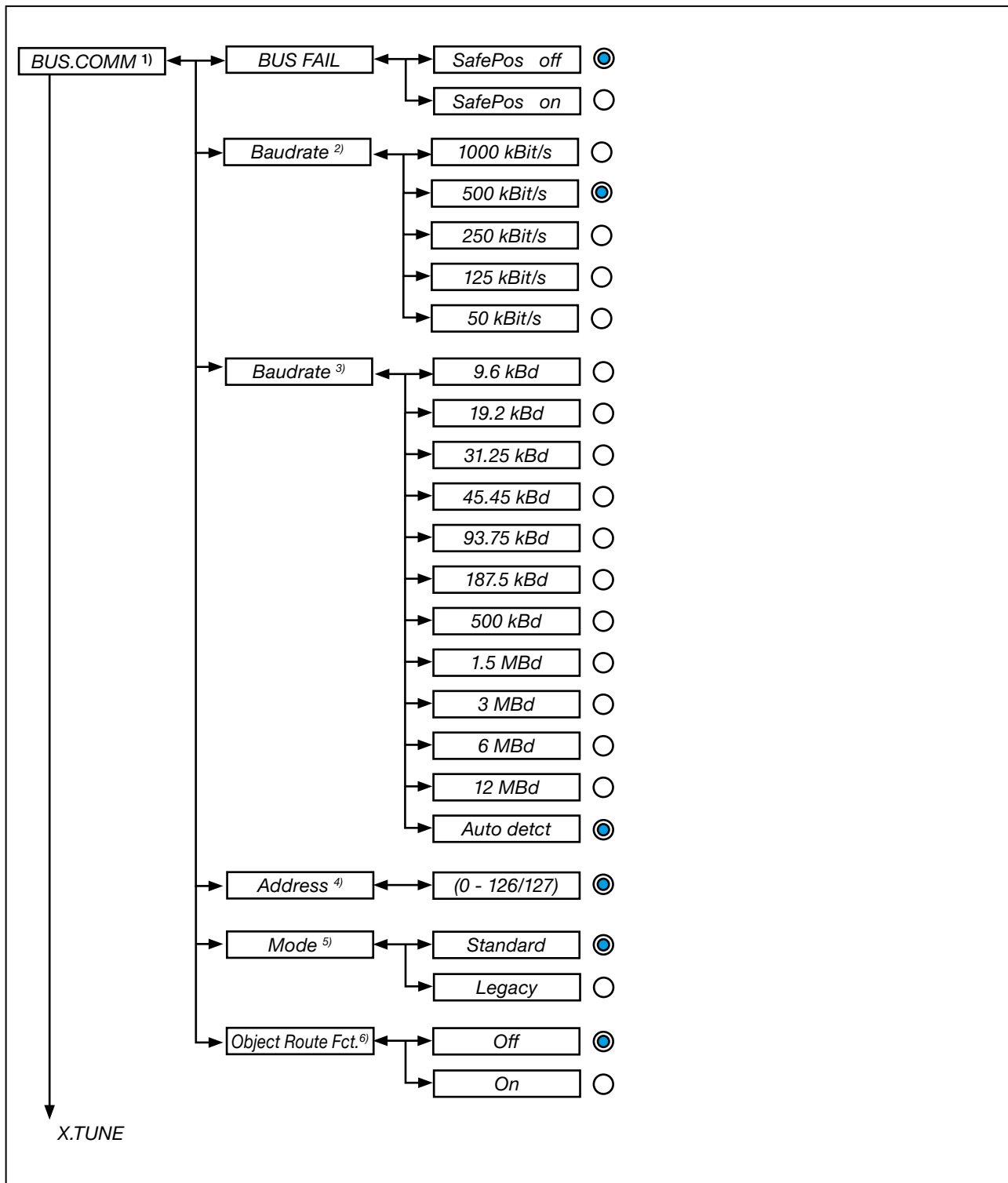


Figure 61: Bedienstruktur - 2

- 1) Only for fieldbus
- 2) Only for büS
- 3) Only for PROFIBUS DPV1
- 4) Only for büS und PROFIBUS DPV1
- 5) Only for EtherNet/IP, PROFINET und Modbus TCP
- 6) Only for EtherNet/IP, PROFINET, Modbus TCP und PROFIBUS DPV1

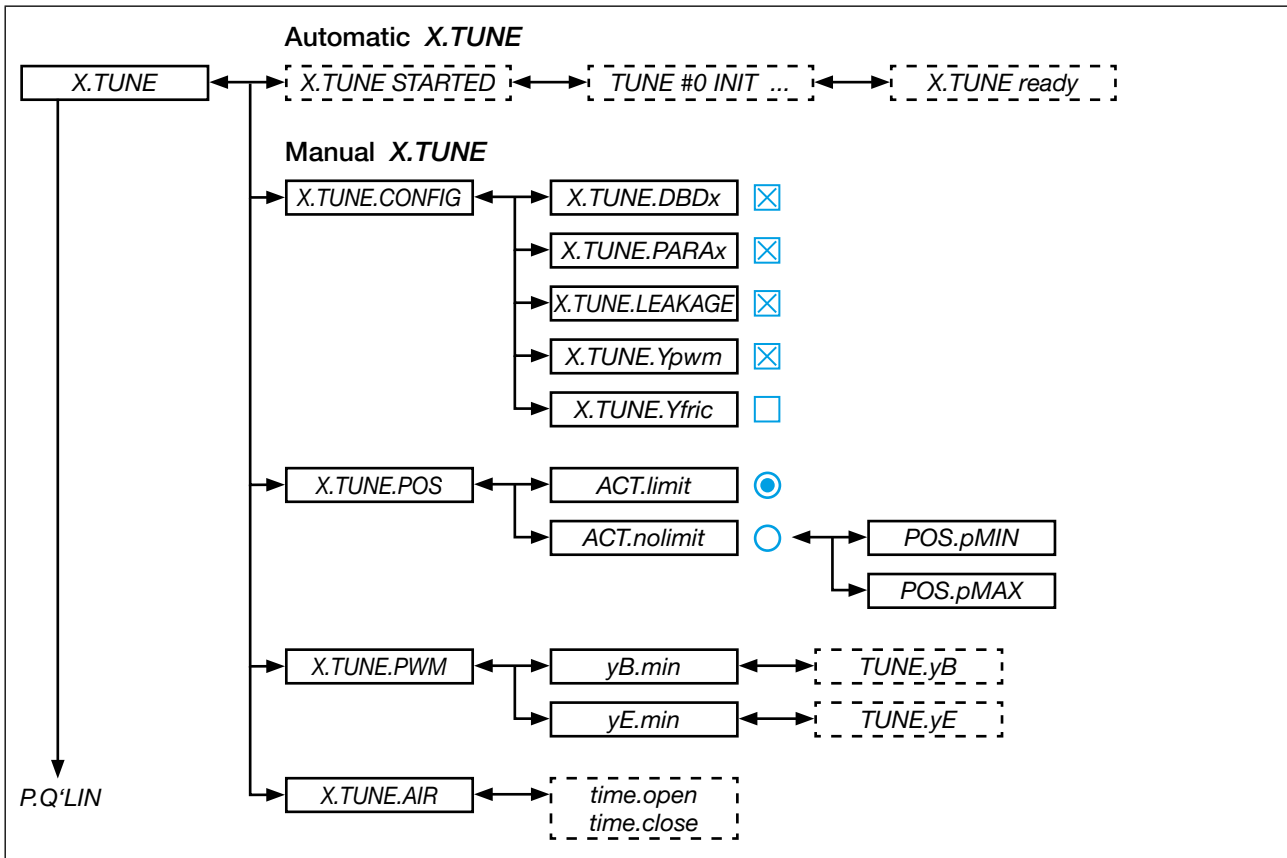


Figure 62: Operating structure - 3

MAN 1000327408 EN Version: N Status: RL (released | freigegeben) printed: 01.09.2023

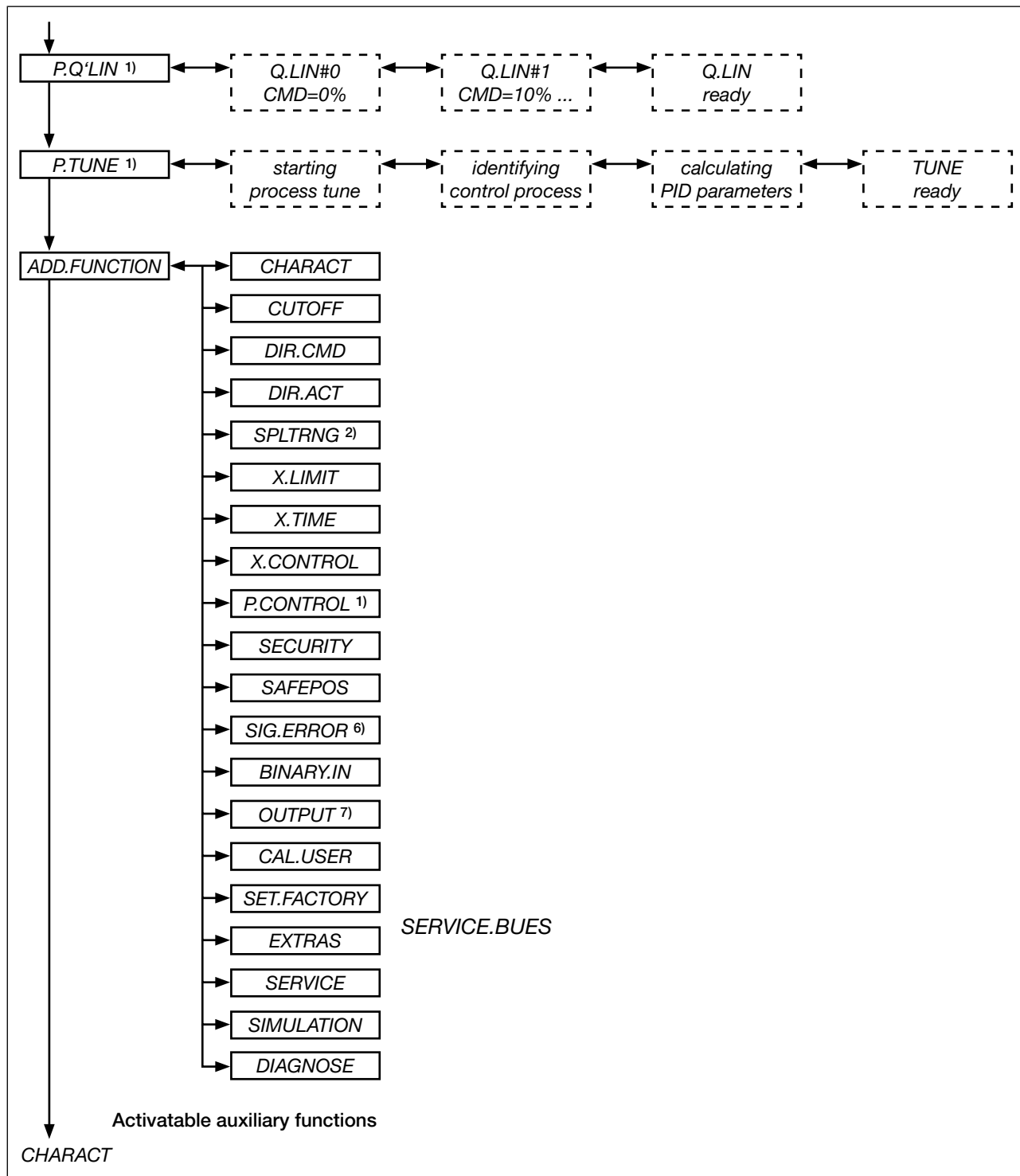


Figure 63: Operating structure - 4

- 1) Only process controller Type 8693
- 2) Only for position controller mode
- 6) Only for signal type 4...20 mA and Pt 100
- 7) Optional. The number of outputs varies depending on the variant.

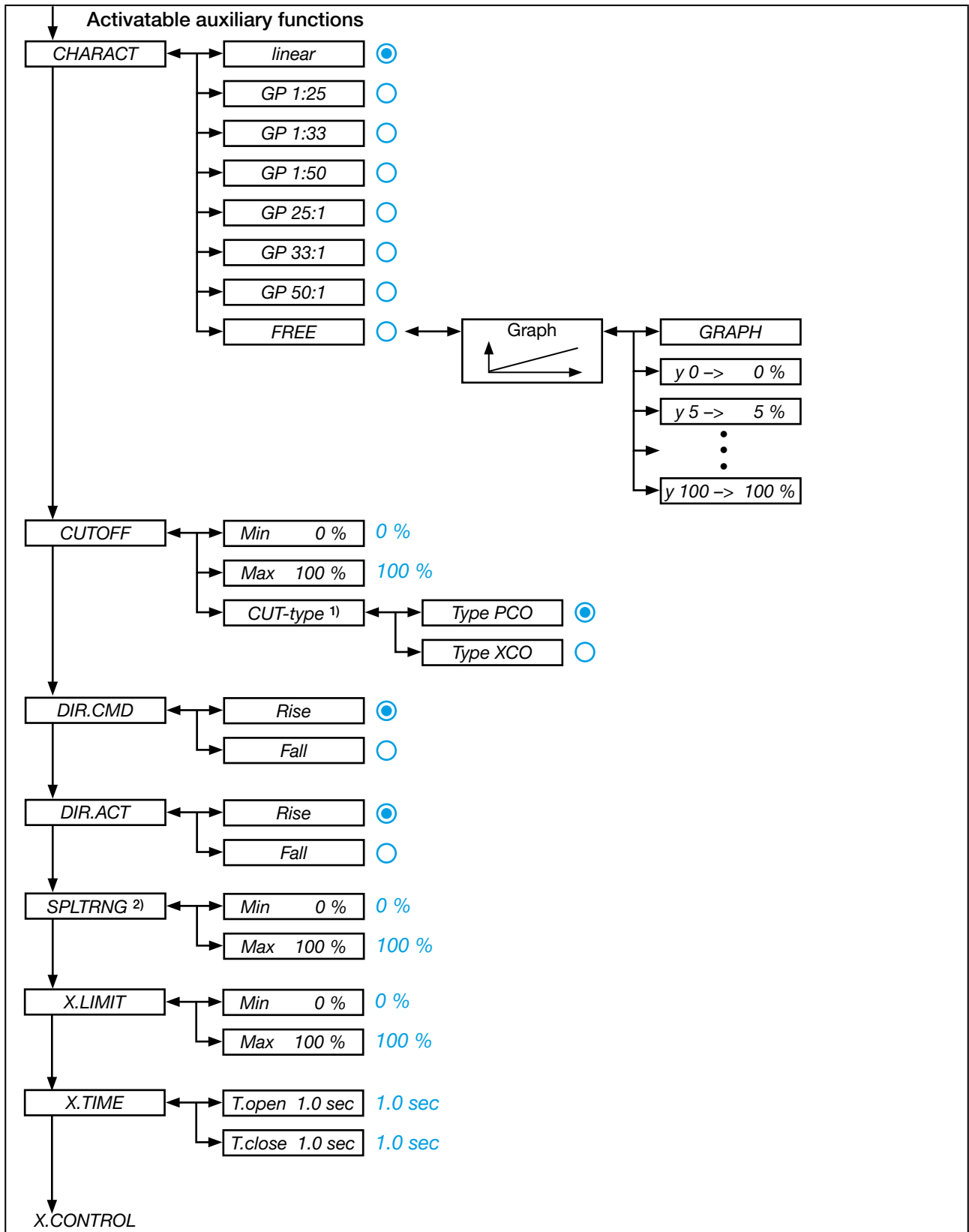


Figure 64: Operating structure - 5

1) Only process controller Type 8693
2) Only for position controller mode

MAN 1000327408 EN Version: N Status: RL (released | freigegeben) printed: 01.09.2023

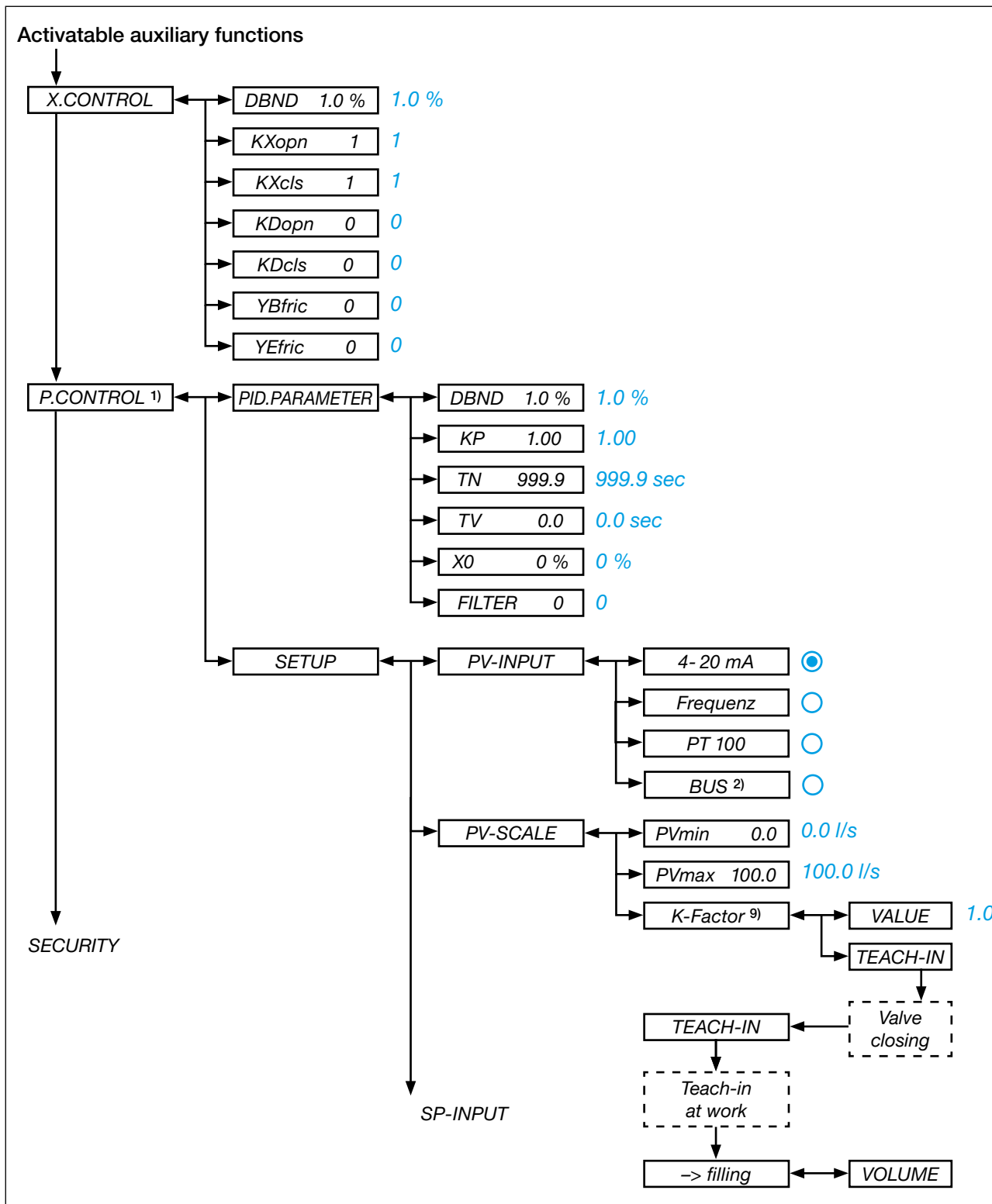


Figure 65: Operating structure - 6

1) Only process controller Type 8693

2) Only for bus devices

9) Only for signal type frequency (P.CONTROL → SETUP → PV-INPUT → frequency)

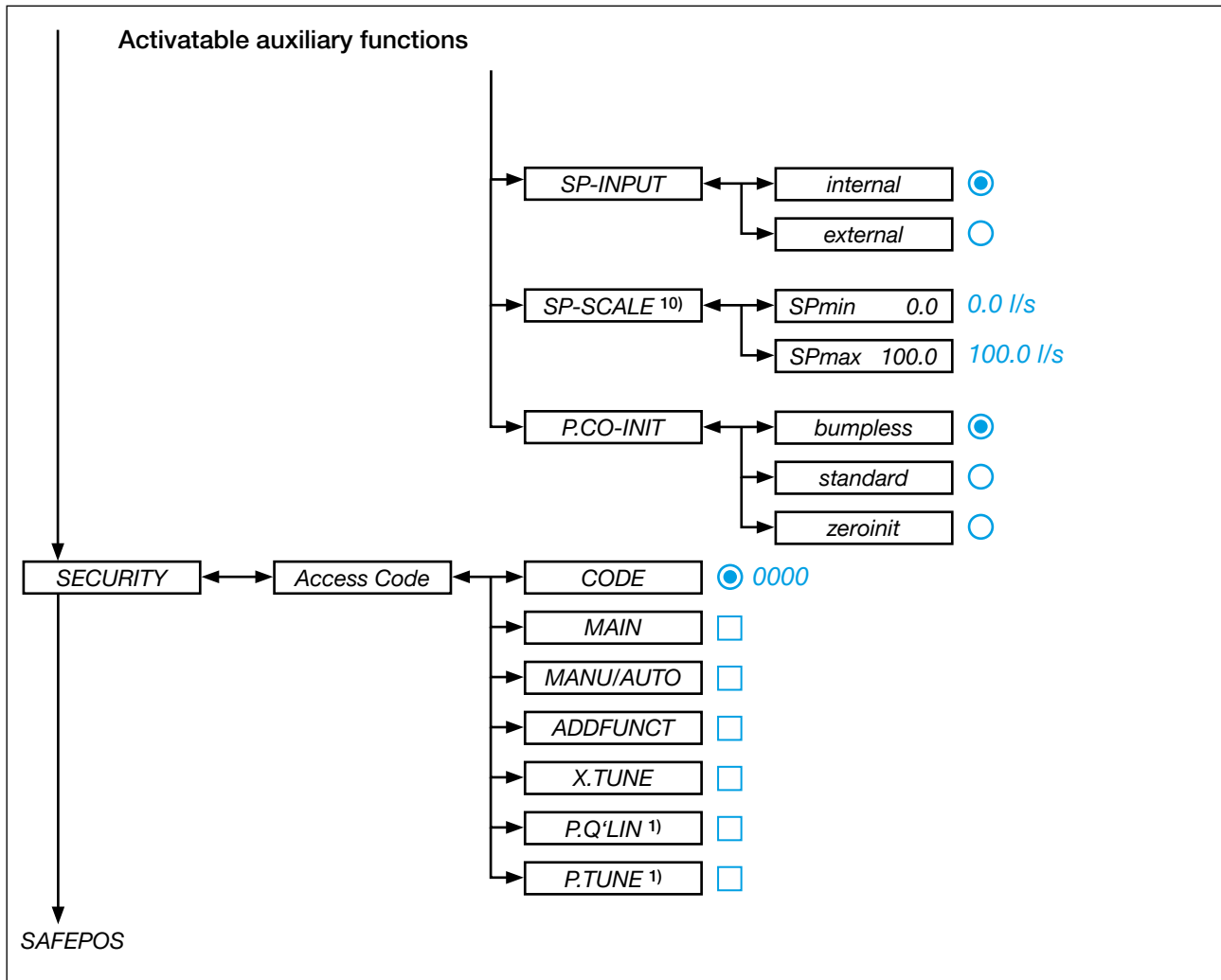


Figure 66: Operating structure - 7

1) Only process controller Type 8693

10) Only process controller Type 8693 and for external set-point value default (P.CONTROL → SETUP → SP-INPUT → external)

MAN 1000327408 EN Version: N Status: RL (released | freigegeben) printed: 01.09.2023

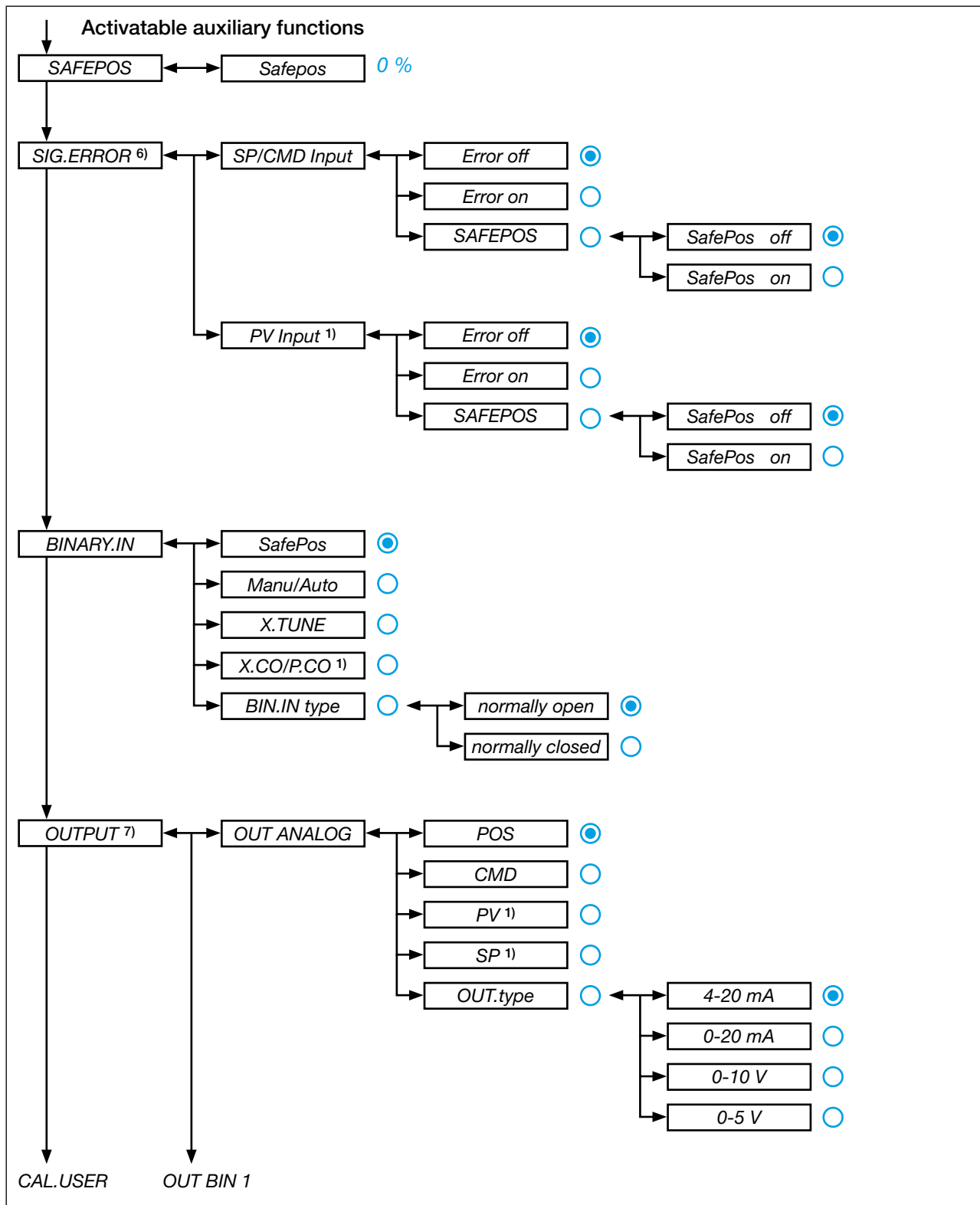


Figure 67: Operating structure - 8

- 1) Only process controller Type 8693
- 6) Only for signal type 4...20 mA and Pt 100
- 7) Optional. The number of outputs varies depending on the variant.

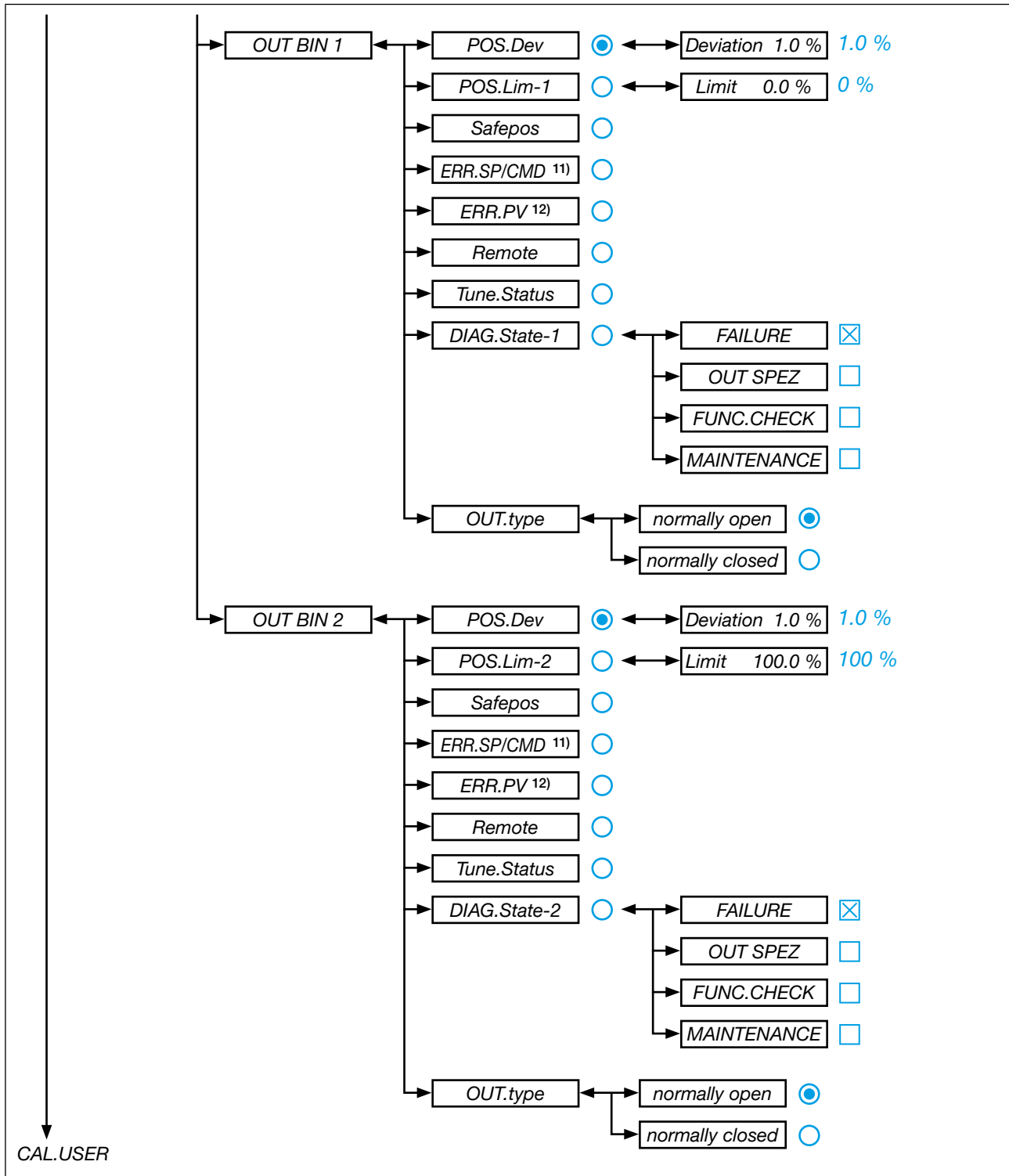
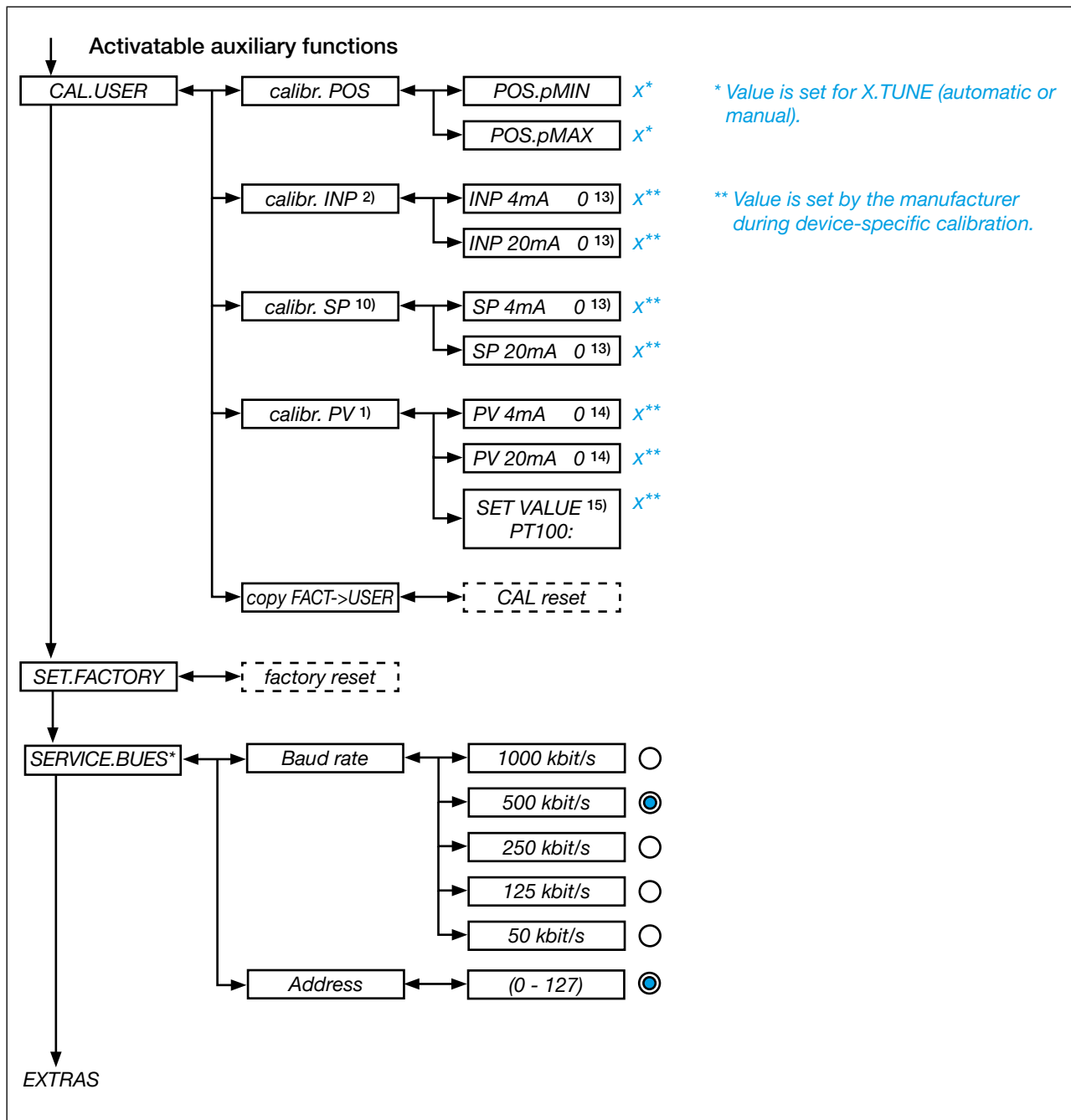


Figure 68: Operating structure - 9

11) Only if fault detection is activated for the input signal
(SIG.ERROR → SP/CMD Input or PV-Input → Error on)

12) Only process controller Type 8693 and if fault detection is activated for the input signal
(SIG.ERROR → SP/CMD Input or PV-Input → Error on)



* Value is set for X.TUNE (automatic or manual).

** Value is set by the manufacturer during device-specific calibration.

MAN 1000327408 EN Version: N Status: RL (released | freigegeben) printed: 01.09.2023

Figure 69: Operating structure - 10

- 1) Only process controller Type 8693
- 2) Only for position controller mode
- 10) Only process controller Type 8693 and for external set-point value default (P.CONTROL → SETUP → SP-INPUT → external)
- 13) The signal type is displayed which is selected in the INPUT menu
- 14) Only for signal type 4...20 mA (P.CONTROL → SETUP → PV-INPUT → 4...20 mA)
- 15) Only for circuit with Pt 100 (P.CONTROL → SETUP → PV-INPUT → PT 100)

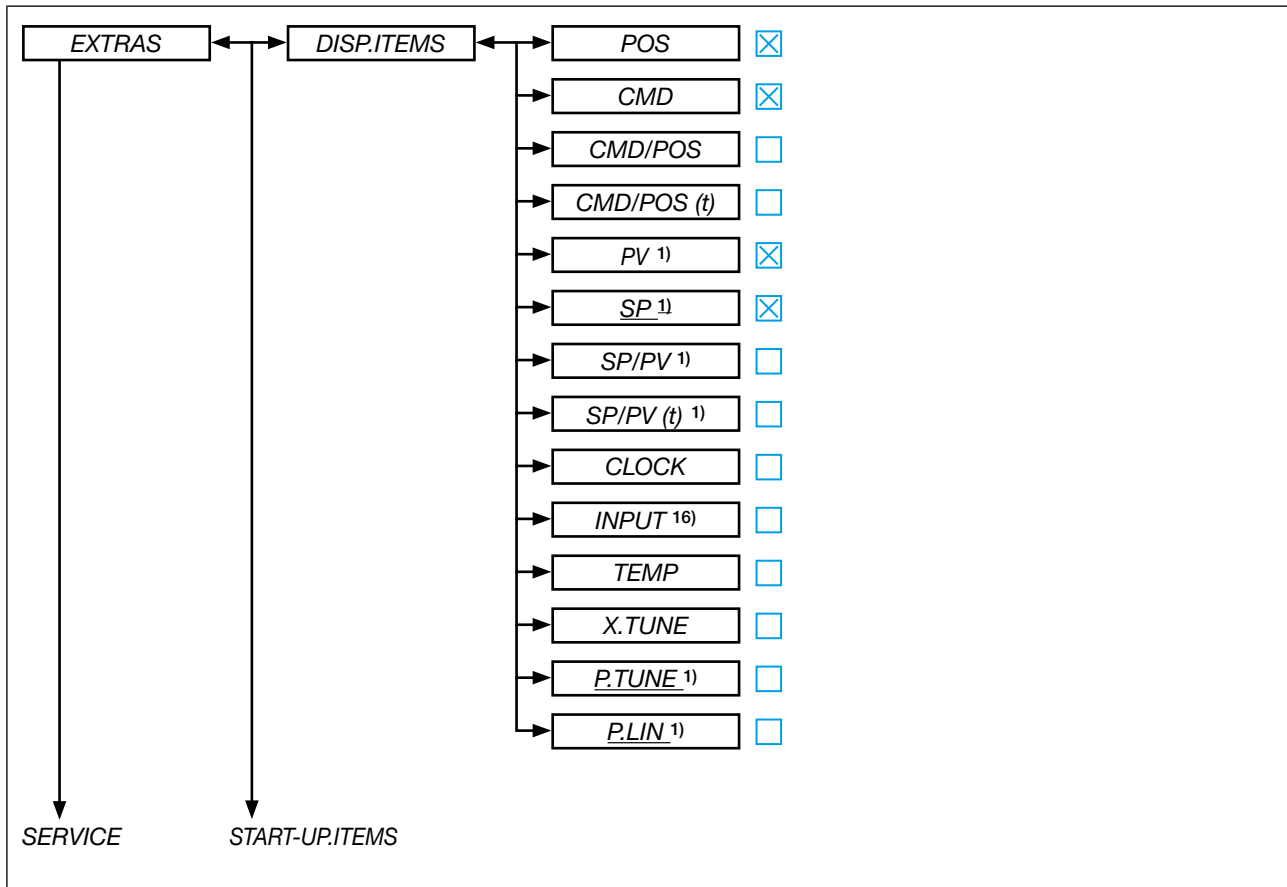


Figure 70: Operating structure - 11

1) Only process controller Type 8693

16) Not for field bus

MAN 1000327408 EN Version: N Status: RL (released | freigegeben) printed: 01.09.2023

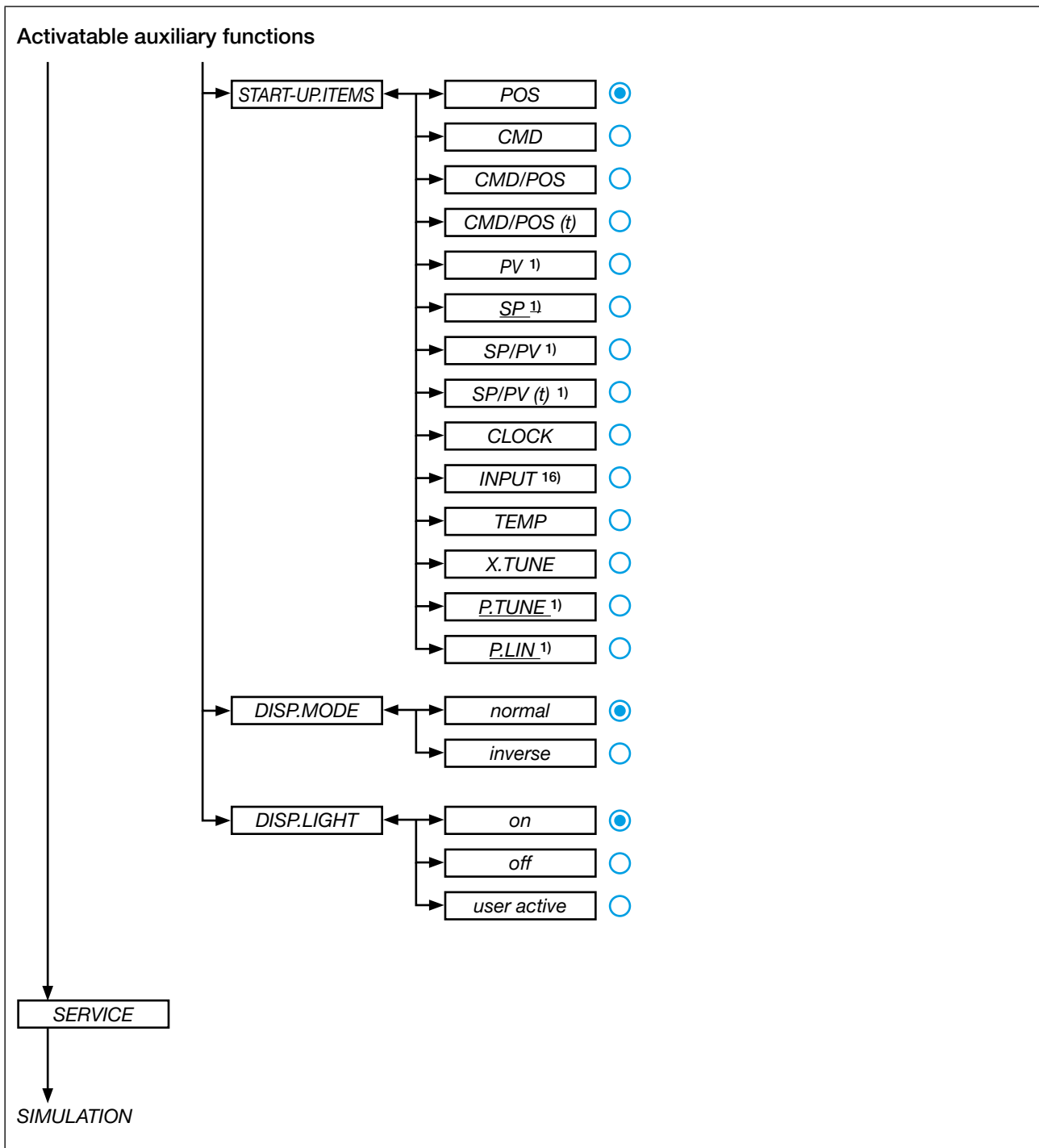


Figure 71: Operating structure - 12

1) Only process controller Type 8693
 16) Not for field bus

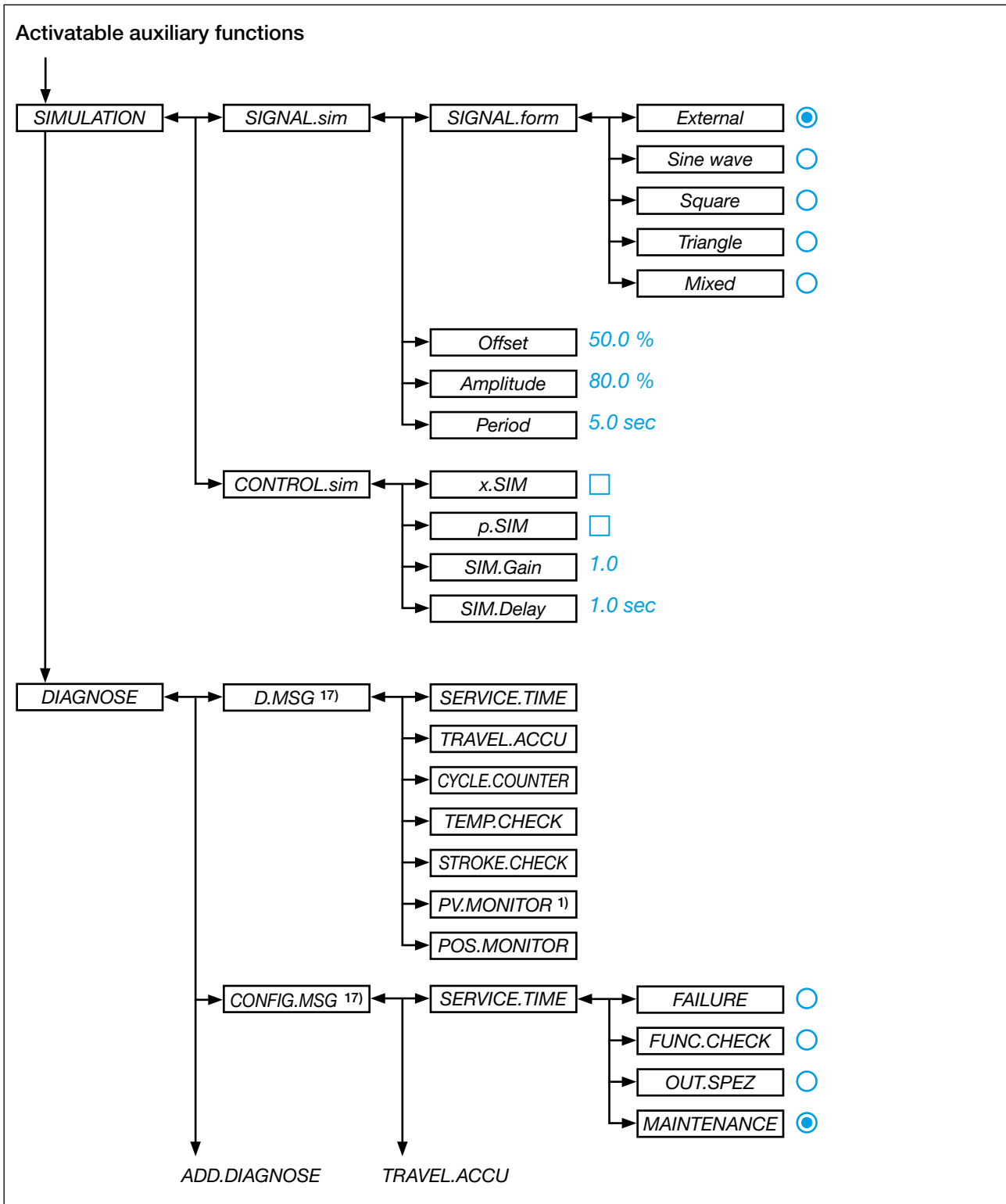


Figure 72: Operating structure - 13

1) Only process controller Type 8693

17) The submenu lists only the activated diagnostic functions

MAN 1000327408 EN Version: N Status: RL (released | freigegeben) printed: 01.09.2023

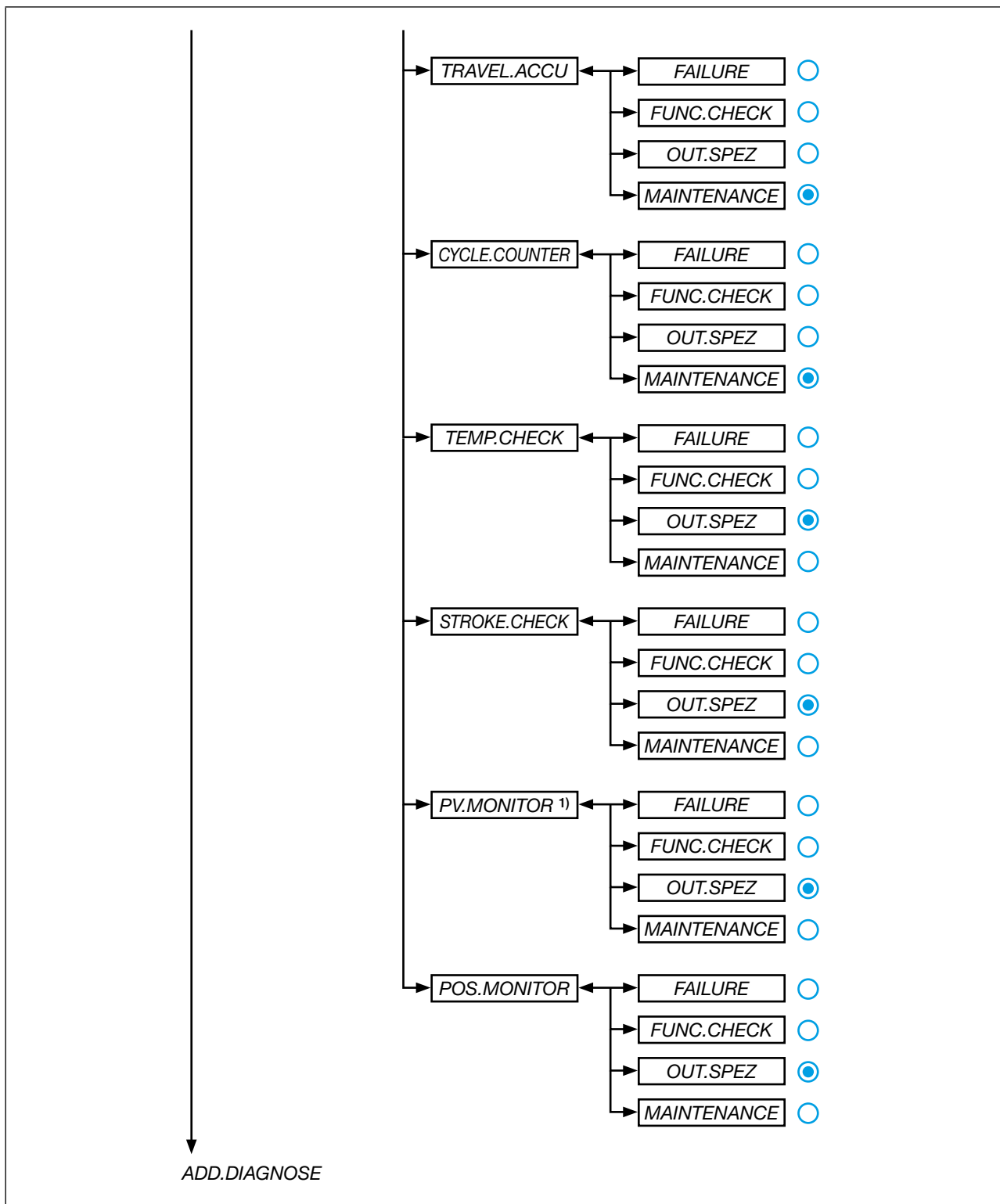


Figure 73: Operating structure - 14

1) Only process controller Type 8693

MAN 1000327408 EN Version: N Status: RL (released | freigegeben) printed: 01.09.2023

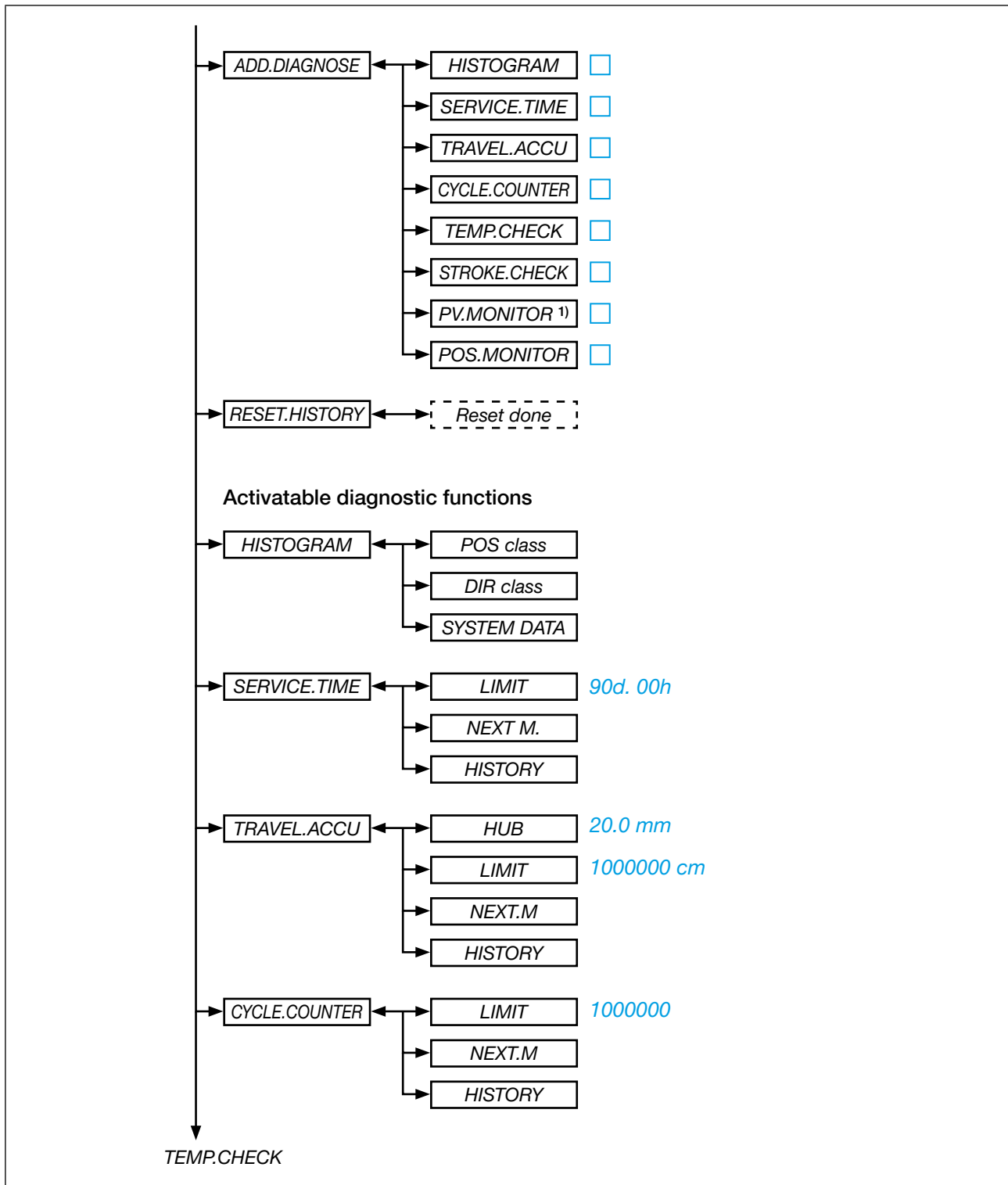


Figure 74: Operating structure - 15

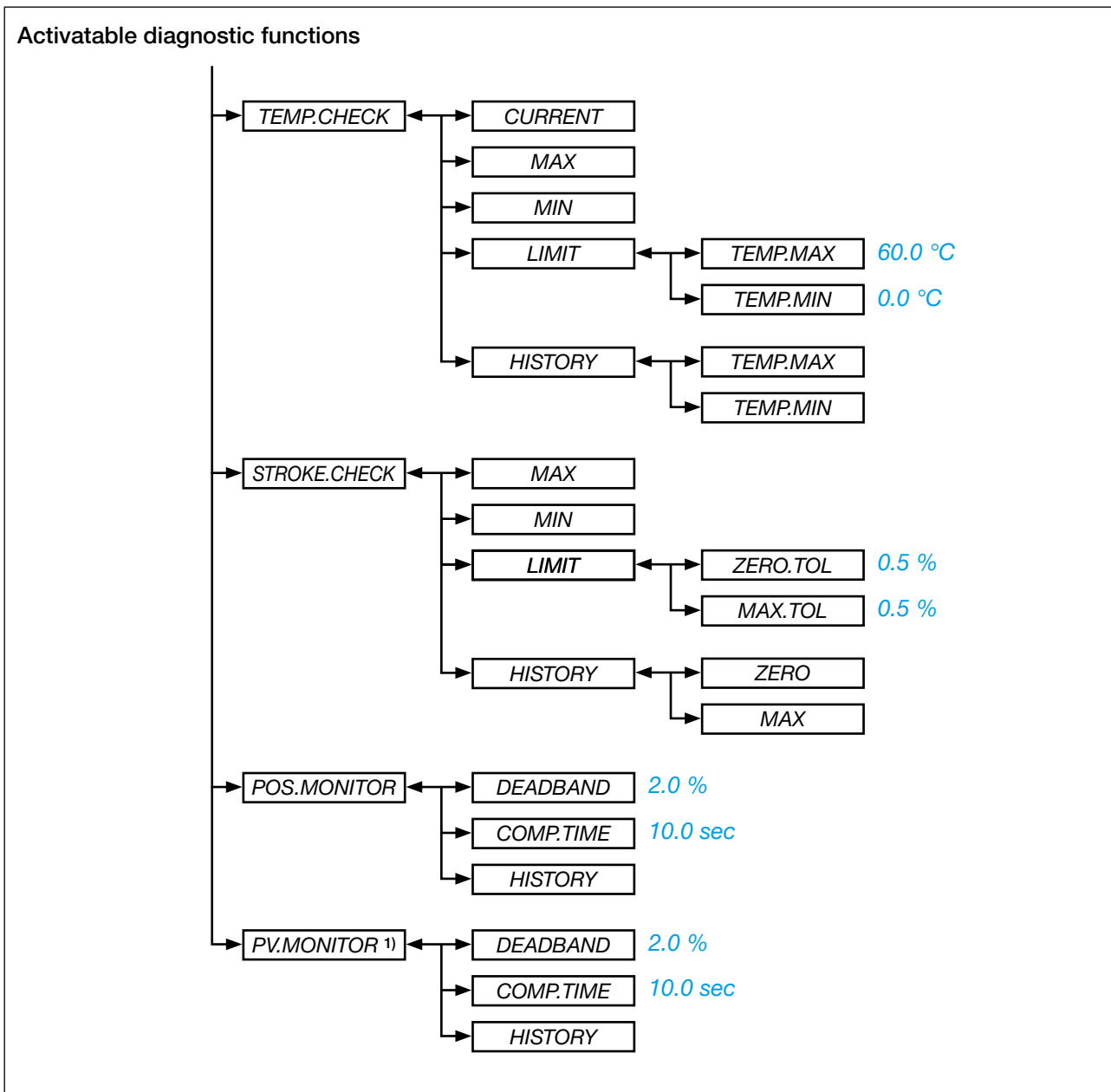


Figure 75: Operating structure - 16

MAN 1000327408 EN Version: N Status: RL (released | freigegeben) printed: 01.09.2023

1) Only process controller Type 8693

19 ETHERNET/IP, PROFINET AND MODBUS TCP



DANGER

Risk of injury due to electric shock.

- ▶ Before reaching into the system, switch off the power supply and secure to prevent reactivation.
- ▶ Observe the applicable accident prevention regulations and safety regulations for electrical equipment.



WARNING

Risk of injury from improper installation.

- ▶ Installation may be carried out by authorized technicians only and with the appropriate tools.

Risk of injury from unintentional activation of the system and uncontrolled restart.

- ▶ Secure system against unintentional activation.
- ▶ Following installation, ensure a controlled restart.

19.1 Technical data

Network speed	10/100 Mbps
Auto negotiation	Yes
Switch function	Yes
Network diagnostics	Yes, via fault telegram
MAC-ID	Individual identification number, stored in the module and on the outside of the device (see type label)
Device name Ethernet (factory settings)	Positioner / process controller (name can be changed)



Configuration of several devices:

All devices are delivered with the same IP address. To ensure that the device can be identified for the configuration, the network may contain only 1 device which has not yet been configured.

- ▶ Connect the devices (Ethernet device) in succession, individually to the network and configure.

19.2 Interfaces

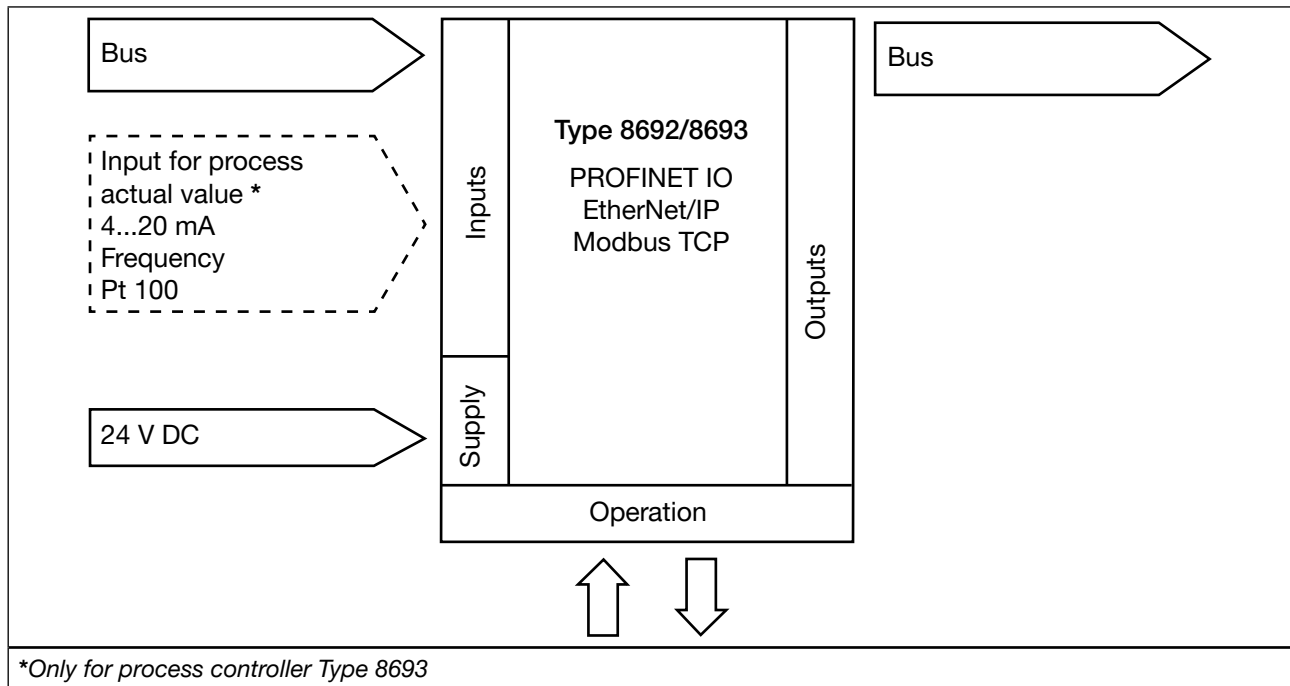


Figure 76: Interfaces Industrial Ethernet

19.3 Industrial Ethernet

PROFINET IO specifications

DNS compatible name	No entry
Static IP address	0.0.0.0
Network mask	0.0.0.0
Default gateway	0.0.0.0

In accordance with the PROFINET specification, these factory settings allow address assignment via the DCP and LLDP services. This means that no additional tools and no new project planning are required when replacing a device.

Topology recognition	LLDP, SNMP V1, MIB2, physical device
Minimum cycle time	10 ms
IRT	not supported
MRP (Media Redundancy)	MRP Client is supported
Additional supported features	DCP, VLAN priority tagging, Shared Device
Transmission speed	100 Mbit/s
Data transport layer	Ethernet II, IEEE 802.3
PROFINET IO specification	V2.3

(AR) Application Relations The device can simultaneously process up to 2 IO-ARs, 1 Supervisor AR and 1 Supervisor DA AR.

EtherNet/IP specifications

Static IP address	192.168.0.100
Network mask	255.255.255.0
Default gateway	192.168.0.1
Predefined standard objects	Identity Object (0x01) Message Router Object (0x02) Assembly Object (0x04) Connection Manager (0x06) DLR Object (0x47) QoS Object (0x48) TCP/IP Interface Object (0xF5) Ethernet Link Object (0xF6)
DHCP	supported
BOOTP	supported
Transmission speed	10 and 100 Mbit/s
Duplex transmission	Half Duplex, full Duplex, autonegotiation
MDI modes	MDI, MDI-X, Auto-MDIX
Data transport layer	Ethernet II, IEEE 802.3
Address Conflict Detection (ACD)	supported
DLR (ring topology)	supported
CIP Reset services	Identity Object Reset Service of Type 0 and 1

Modbus TCP specifications

Static IP address	192.168.0.100
Network mask	255.255.255.0
Default gateway	192.168.0.1
Modbus Function Codes	1, 2, 3, 4, 6, 15, 16, 23
Mode	Message Mode: Server
Transmission speed	10 and 100 Mbit/s
Data transport layer	Ethernet II, IEEE 802.3

MAN 1000327408 EN Version: N Status: RL (released | freigegeben) printed: 01.09.2023

19.4 Differences between the fieldbus devices and devices without a field bus

The following chapters of these operating instructions are not valid for Type 8692, 8693 with Ethernet.

- Section “Installation” chapter „12 Electrical installation without fieldbus communication“
- Section “Start-up“ chapter „14.2 INPUT - Setting the input signal“
- Section “Auxiliary functions” chapter „16.1.7 SPLTRNG – Signal split range“

Chapter „16.1.17 CAL.USER – Calibration of actual value and set-point value“

- *calibr.INP* menu option, calibration of the set-point position
- *calibr.SP* menu option, calibration of the process set-point value

Chapter „16.1.15 BINARY.IN – Activation of the digital input“

Chapter „16.1.16 OUTPUT – Configuration of the outputs (option)“

19.5 Electrical connection

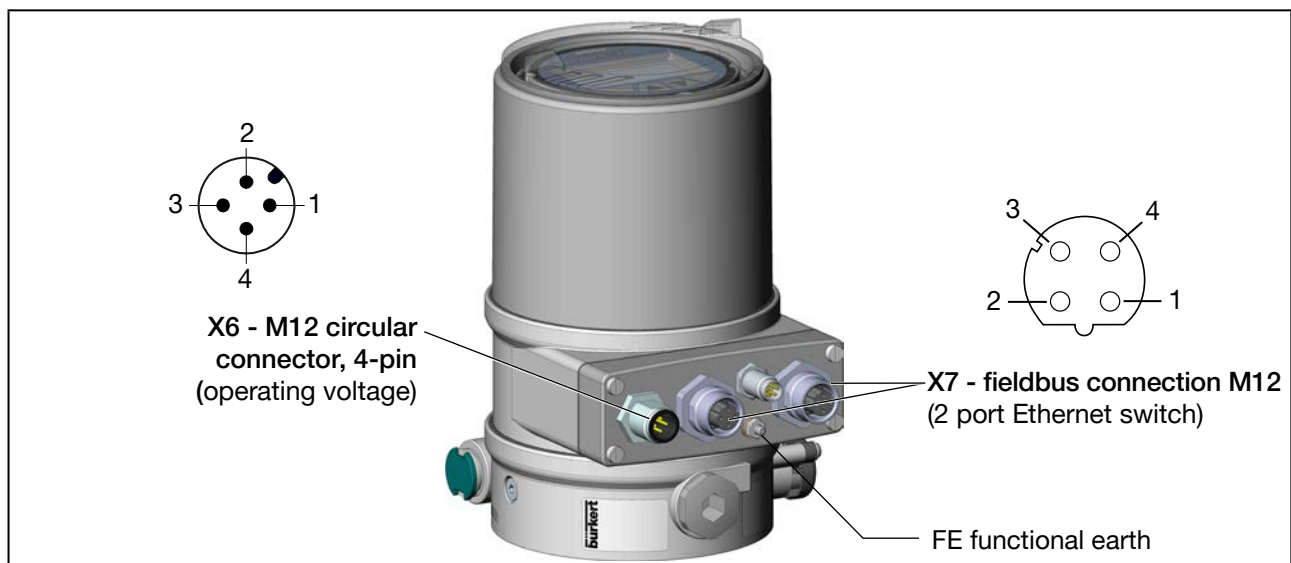


Figure 77: Connection

The EtherNet/IP is connected with an M12 circular plug-in connector, 4-pin D-coded.

X7 - M12 field bus connection D-coded:

	Pin 1	Transmit +
	Pin 2	Receive +
	Pin 3	Transmit -
	Pin 4	Receive -

Table 49: Electrical assignment EtherNet/IP

X6 - M12 circular connector, 4-pin:

Pin	Wire color*	Assignment
1	brown	Operating voltage + 24 V DC
2	Not used	
3	blue	Operating voltage GND
4	Not used	

* The indicated colors refer to the connection cable available as an accessory (918038).

Table 50: X6 - M12 circular connector, 4-pin (operating voltage)

NOTE!

To ensure electromagnetic compatibility (EMC), use a shielded Ethernet cable. Ground the cable shield on both sides, on each of the connected devices.
For the grounding use a short line (max. 1 m) with a cross-section of at least 1.5 mm².

19.6 BUS.COMM – Settings on Type 8692, 8693

Set the following menu options in the *BUS.COMM* menu for start-up of the Ethernet variant:

Activate or deactivate approach of the safety position

Selection – The actuator remains in the position which corresponds to the set-point value last transferred (default setting).

Selection – If there is a fault in the bus communication, the behavior of the actuator depends on the activation of the *SAFEPOS* auxiliary function. See chapter „16.1.13 *SAFEPOS* – Inputting the safety position“.

SAFEPOS activated: The actuator moves to the safety position which is specified in the *SAFEPOS* auxiliary function.

SAFEPOS deactivated: The actuator moves to the safety end position which it would assume if the electrical and pneumatic auxiliary power failed.
See chapter „10.8 Safety end positions after failure of the electrical or pneumatic auxiliary power“.

Setting the fieldbus mode (from software version B.11.00.00, a device restart will be required after a change)

Selection – Suitable for use with device description files from version 2.00.

Selection – Compatibility mode with software version up to and including B.10.00.00

Activate or deactivate Object Route Function ORF (from software version B.11.00.00, a device restart will be required after a change)

Selection – No access to individual objects in the büS network (default setting).

Selection – Allows access to individual objects in the büS network (see document Fieldbus Description: Communication, running cyclical commands, access to büS objects)

19.7 Bus status display

The bus status is indicated on the display on the device.

Display (is displayed approx. every 3 seconds)	Device state	Explanation	Troubleshooting
<i>BUS no connection</i>	Online, No connection to the master.	Device is connected correctly to the bus, the network access procedure has ended without errors, however there is no established connection to the master.	<ul style="list-style-type: none"> • New connection established by master.
<i>BUS critical err</i>	Critical bus fault.	Other device with the same address in the network. <i>BUS offline</i> due to communication problems.	<ul style="list-style-type: none"> • Change address of the device and restart device. • Fault analysis in the network with a bus monitor.

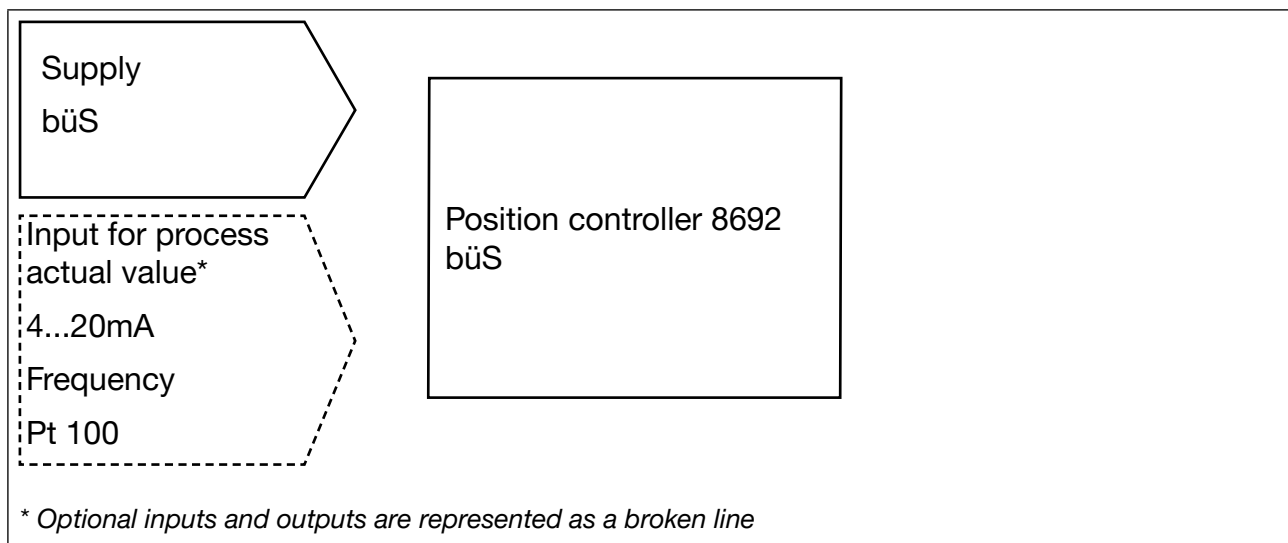
Table 51: Bus status display; Ethernet

20 büS OPTION

20.1 Definition

büS is a field bus which is based on CANopen with additional functionality for networking several devices.

20.2 Interfaces



20.3 Electrical installation - büS

20.3.1 Safety instructions



DANGER

Risk of injury due to electric shock.

- ▶ Before reaching into the system, switch off the power supply and secure to prevent reactivation.
- ▶ Observe the applicable accident prevention regulations and safety regulations for electrical equipment.



WARNING

Risk of injury from improper installation.

- ▶ Installation may be carried out by authorized technicians only and with the appropriate tools.

Risk of injury from unintentional activation of the system and uncontrolled restart.

- ▶ Secure system against unintentional activation.
- ▶ Following installation, ensure a controlled restart.

20.3.2 Electrical connection

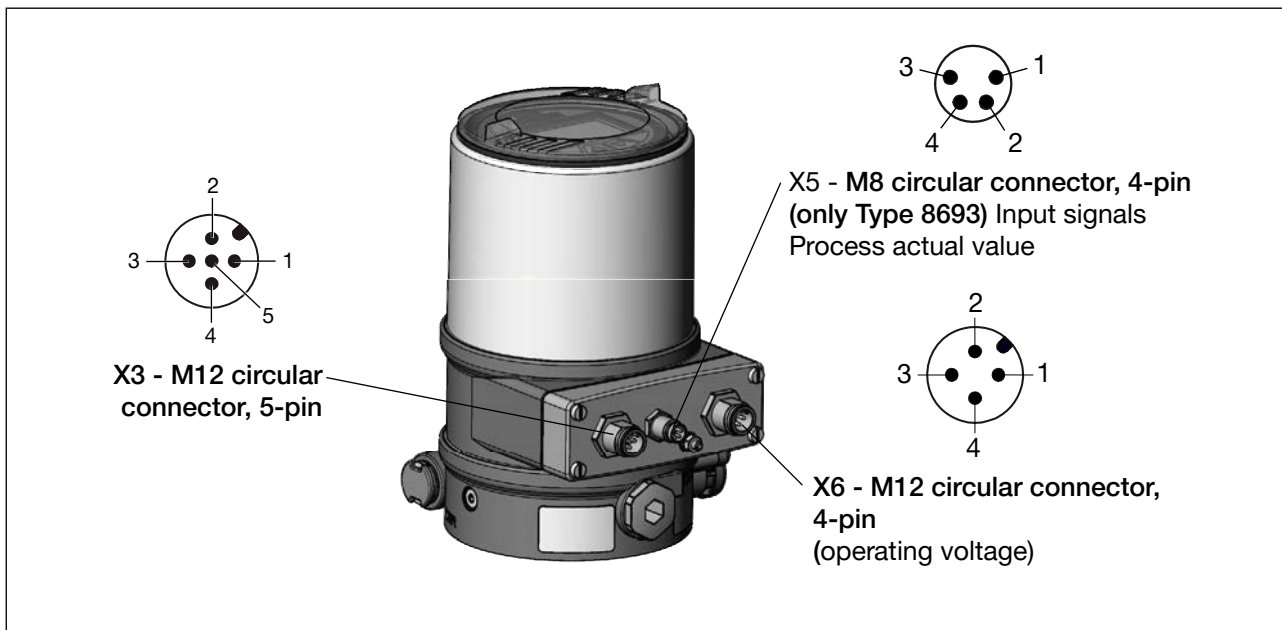


Figure 78: Electrical connection (example Type 8693)

X3 - circular connector M12x1, 5-pin, male:

Pin	Wire color	Assignment
1	CAN shield	CAN shield
2	Not used	
3	Black	Black GND / CAN_GND
4	White	White CAN_H
5	Blue	Blue CAN_L

Table 52: X3 - M12 circular connector, 5-pin

X6 - circular connector M12x1, 4-pin:


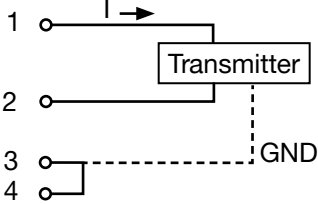
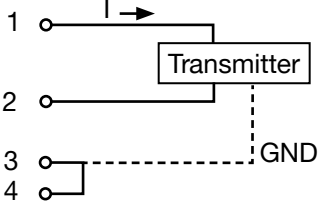




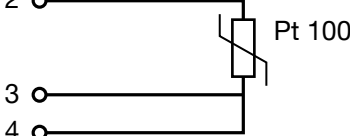
Pin	Wire color*	Assignment
1	brown	Operating voltage + 24 V DC
2	Not used	
3	blue	Operating voltage GND
4	Not used	

* The indicated colors refer to the connection cable available as an accessory (918038).

Table 53: X6 - M12 circular connector, 4-pin (operating voltage)

MAN 1000327408 EN Version: N Status: RL (released | freigegeben) printed: 01.09.2023

X5 - M8 circular connector, 4-pin - input signals process actual value (only Type 8693)

input type*	Pin	Wire color **	Assignment	Switch ***	On the device side	External circuit
4 ... 20 mA - internally supplied	1 2 3 4	brown white blue black	+24 V supply transmitter Output of transmitter GND (identical with GND operating voltage) Bridge to GND (GND from 3-wire transmitter)	 Switch on left		
4 ... 20 mA - externally supplied	1 2 3 4	brown white blue black	not assigned Process actual + not assigned Process actual -	 Switch on right	2 ○ — 4 ... 20 mA 4 ○ — GND 4 ... 20 mA	
Frequency - internally supplied	1 2 3 4	brown white blue black	+24 V sensor supply Clock input + Clock input - (GND) not assigned	 Switch on left	1 ○ — +24 V 2 ○ — Clock + 3 ○ — Clock - / GND (identical with GND operating voltage)	
Frequency - externally supplied	1 2 3 4	brown white blue black	not assigned Clock input + Clock input - not assigned	 Switch on right	2 ○ — Clock + 3 ○ — Clock -	
Pt 100 (see note below) ****	1 2 3 4	brown white blue black	not assigned Pt 100 current feed Pt 100 GND Pt 100 compensation	 Switch on right	2 ○ — 3 ○ — 4 ○ —	

* Can be adjusted via software (see chapter „15.2.1 PV-INPUT – Specifying signal type for the process actual value“).

** The indicated colors refer to the connection cable available as an accessory (264602).

*** The switch is situated under the screw joint (see „Figure 80: Electrical connection PROFIBUS DPV1, Typ 8692/8693“).

Table 54: X5 - M8 circular connector, 4-pin - input signals process actual value (only Type 8693)



**** For reasons of wire resistance compensation, connect the Pt 100 sensor via 3 wires. Always bridge Pin 3 and Pin 4 on the sensor.



Electrical installation with or without büS network:

To be able to use the büS network (CAN interface), a 5-pin circular connector and a shielded 5-wire cable must be used.

20.3.3 Switch position (only type 8693)

For the “internally supplied” input type, the GND signal of the process actual value must be connected to the GND signal of the operating voltage. A bridge is established internally between both GND signals using the “left” switch position.


Supplied	Assignment	Switch position
Internally supplied	GND process actual value equal to GND operating voltage	Switch on left
Externally supplied	GND process actual value electrically isolated from GND operating voltage	Switch on right


Table 55: Switch position

20.4 BUS.COMM – Settings on Type 8692, 8693

Set the following menu options in the *BUS.COMM* menu for start-up:

BUS FAIL Activate or deactivate approach of the safety position

Selection **SafePos off**  – The actuator remains in the position which corresponds to the set-point value last transferred (default setting).

Selection **SafePos on**  – If there is a fault in the bus communication, the behavior of the actuator depends on the activation of the *SAFEPOS* auxiliary function. See chapter „16.1.13 *SAFEPOS* – Inputting the safety position“.

SAFEPOS activated: The actuator moves to the safety position which is specified in the *SAFEPOS* auxiliary function.

SAFEPOS deactivated: The actuator moves to the safety end position which it would assume if the electrical and pneumatic auxiliary power failed.
See chapter „10.8 Safety end positions after failure of the electrical or pneumatic auxiliary power“.

BUS.COMM is set as follows:

→  Press **MENU** for 3 s. Switching from process level ⇒ setting level.

Select  **BUS.COMM**. Selection in the main menu (MAIN).

→  Select **ENTER**. The submenu options for basic settings can now be selected.

Setting device address:

(for bÜS devices the address is automatically set)

→  Select address.


→  Select **INPUT**. The input screen is opened.

→   Increase value or  reduce value. Enter a device address (value between 0 and 127).


→  Select **OK**. Return to *BUS.COMM*.

Select baud rate:

→ Select ▲ / ▼ *BAUD RATE*.

→  Select **ENTER**. The input screen is opened.

→ Select ▲ / ▼ *BAUD RATE*. 50 kBd / 125 kBd / 250 kBd / 500 kBd / 1000 kBd

→  Select **SELECT**. The selection is now marked by a filled circle ●.

→  Select **EXIT**. Return to *BUS.COMM*.

✔ You have set *BUS.COMM*.



With büS devices not only the büS service interface but also the Bürkert Communicator can be connected directly to the büS network.

21 PROFIBUS DPV1

21.1 Technical data

The protocol sequence complies with the standard DIN 19245 Part 3.

Type 8692:

GSD file	BUER1170.GSD
Bitmap file	BUER1170.BMP
PNO-ID.	0x1170

Type 8693:

GSD file	BUER1171.GSD
Bitmap file	BUER1171.BMP
PNO-ID.	0x1171

Type 8750:

GSD file	BUER1172.GSD
Bitmap file	BUER1172.BMP
PNO-ID.	0x1172

Baud rate	Max. 12 Mbaud (is automatically set by the Type 8692/8693)
-----------	---

Sync and Freeze mode	Are supported
----------------------	---------------

Diagnostic telegramm	No device-specific
----------------------	--------------------

Diagnostic parameter telegramm	No user parameters
--------------------------------	--------------------

The process data is configured in the PROFIBUS DP master

21.2 Interfaces

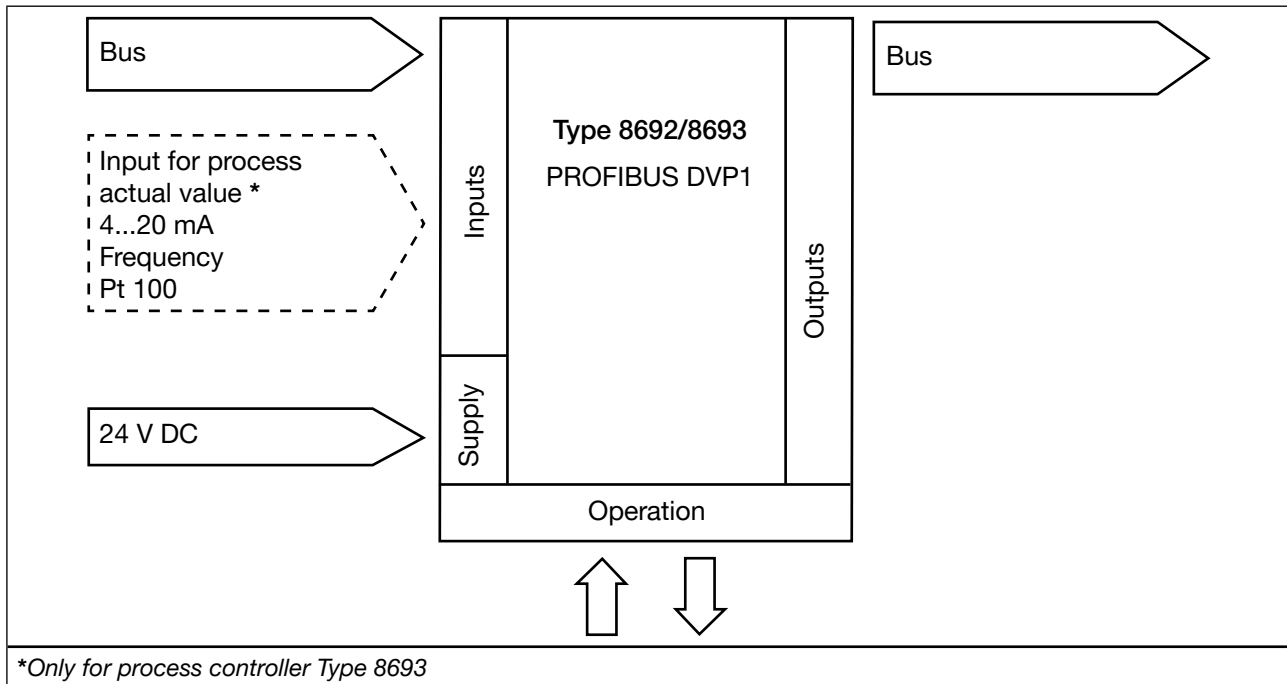


Figure 79: Interfaces PROFIBUS DVP1

21.3 Differences between the fieldbus devices and devices without a field bus

The following chapters of these operating instructions are not valid for Type 8692, 8693 with PROFIBUS DPV1.

- Section "Installation" chapter „12 Electrical installation without fieldbus communication“
- Section "Start-up" chapter „14.2 INPUT - Setting the input signal“
- Section "Auxiliary functions" chapter „16.1.7 SPLTRNG – Signal split range“

Chapter „16.1.17 CAL.USER – Calibration of actual value and set-point value“

- *calibr.INP* menu option, calibration of the set-point position
- *calibr.SP* menu option, calibration of the process set-point value

Chapter „16.1.15 BINARY.IN – Activation of the digital input“

Chapter „16.1.16 OUTPUT – Configuration of the outputs (option)“

21.4 Electrical connections

DANGER!

Risk of injury due to electrical shock.

- ▶ Before reaching into the device or the equipment, switch off the operating voltage and secure to prevent reactivation.
- ▶ Observe applicable accident prevention and safety regulations for electrical equipment.

WARNING!

Risk of injury from improper installation.

- ▶ Installation may be carried out by authorized technicians only and with the appropriate tools.

Risk of injury from unintentional activation of the system and an uncontrolled restart.

- ▶ Secure system from unintentional activation.
- ▶ Following installation, ensure a controlled restart.

Procedure:

→ Connect Type 8692/8693 according to the tables.

On the electrical connection housing is a setscrew with nut for connection of the functional earth.

→ Connect setscrew to a suitable grounding point. To ensure electromagnetic compatibility (EMC), ensure that the cable is as short as possible (max. 30 cm, Ø 1.5 mm²).

When the operating voltage is applied, Type 8692/8693 is operating.

→ Now make the required basic settings and adjustments for the positioner/process controller.

NOTE!

Electromagnetic compatibility (EMC) is only ensured if the appliance is connected correctly to an earthing point.

On the outside of the housing is a FE terminal for connection of the functional earth (FE).

- ▶ Connect the FE terminal to the earthing point via a shortest possible cable (maximum length 30 cm).

21.4.1 Connection diagram PROFIBUS DPV1

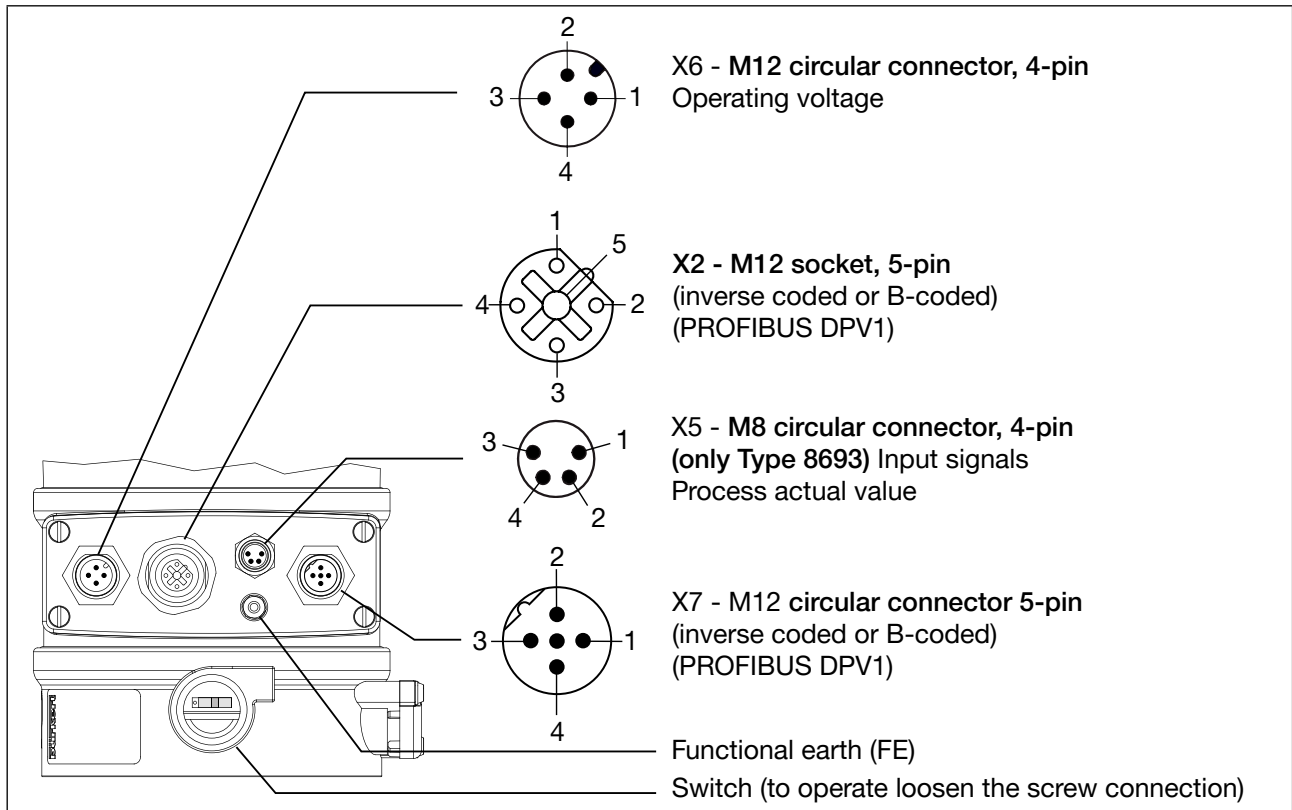


Figure 80: Electrical connection PROFIBUS DPV1, Typ 8692/8693

X2, X7 - M12 socket/circular connector, 5-pin (bus connection)

Pin	Configuration	External circuit / Signal level
1	VP+5	Supply the terminating resistors
2	RxD/TxD-N	Received/transmitted data -N, A-line
3	DGND	Data transmission potential (earth to 5 V)
4	RxD/TxD-P	Received/transmitted data -P, B-line
5	Not used	

Table 56: X2, X7 - M12 socket/circular connector, 5-pin - bus connection, PROFIBUS DPV1


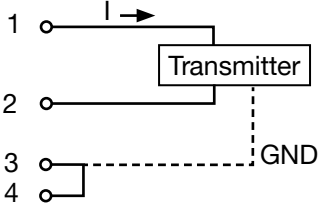
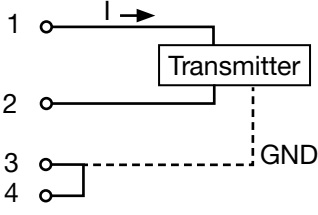




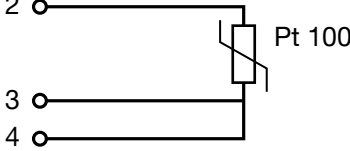
X6 - M12 circular connector, 4-pin (operating voltage)

Pin	Wire color*	Configuration	On the device side	External circuit / Signal level
1	brown	+24 V	1	
2		Not used		
3	blue	GND	3	
4		Not used		

* The indicated wire colours refer to the connection cable, part no. 918038, available as an accessory.

Table 57: X6 - M12 circular connector, 4-pin (operating voltage)

X5 - M8 circular connector, 4-pin - input signals process actual value (only Type 8693)

input type*	Pin	Wire color **	Assignment	Switch ***	On the device side	External circuit
4 ... 20 mA - internally supplied	1 2 3 4	brown white blue black	+24 V supply transmitter Output of transmitter GND (identical with GND operating voltage) Bridge to GND (GND from 3-wire transmitter)	 Switch on left		
4 ... 20 mA - externally supplied	1 2 3 4	brown white blue black	not assigned Process actual + not assigned Process actual -	 Switch on right	2 ○ — 4 ... 20 mA 4 ○ — GND 4 ... 20 mA	
Frequency - internally supplied	1 2 3 4	brown white blue black	+24 V sensor supply Clock input + Clock input - (GND) not assigned	 Switch on left	1 ○ — +24 V 2 ○ — Clock + 3 ○ — Clock - / GND (identical with GND operating voltage)	
Frequency - externally supplied	1 2 3 4	brown white blue black	not assigned Clock input + Clock input - not assigned	 Switch on right	2 ○ — Clock + 3 ○ — Clock -	
Pt 100 (see note below) ****	1 2 3 4	brown white blue black	not assigned Pt 100 current feed Pt 100 GND Pt 100 compensation	 Switch on right	2 ○ — 3 ○ — 4 ○ —	

* Can be adjusted via software (see chapter „15.2.1 PV-INPUT – Specifying signal type for the process actual value“).

** The indicated colors refer to the connection cable available as an accessory (264602).

*** The switch is situated under the screw joint (see „Figure 80: Electrical connection PROFIBUS DPV1, Typ 8692/8693“).

Table 58: X5 - M8 circular connector, 4-pin - input signals process actual value (only Type 8693)

! ** For reasons of wire resistance compensation, connect the Pt 100 sensor via 3 wires. Always bridge Pin 3 and Pin 4 on the sensor.**

MAN 1000327408 EN Version: N Status: RL (released | freigegeben) printed: 01.09.2023

21.4.2 Switch position (only type 8693)

For the “internally supplied” input type, the GND signal of the process actual value must be connected to the GND signal of the operating voltage. A bridge is established internally between both GND signals using the “left” switch position.

Supplied	Assignment	Switch position
Internally supplied	GND process actual value equal to GND operating voltage	Switch on left
Externally supplied	GND process actual value electrically isolated from GND operating voltage	Switch on right

Table 59: Switch position

21.5 Start-up PROFIBUS DPV1



WARNING!

Risk of injury from improper operation.

Improper operation may result in injuries as well as damage to the device and the area around it.

- ▶ Before start-up, ensure that the operating personnel are familiar with and completely understand the contents of the operating instructions.
- ▶ Observe the safety instructions and intended use.
- ▶ Only adequately trained personnel may start up the equipment/the device.

21.5.1 Start-up sequence

For start-up of Type 8692/8693 PROFIBUS DPV1 the following basic settings are required:

Device type	Sequence	Type of basic setting	Setting via	Description in chapter
8692 and 8693	1	Adjust device to the local conditions	<i>X.TUNE</i>	14.3
For 8693 only (Process control)	2	Activate process controller.	<i>ADD.FUNCTION</i>	14.4
8692 and 8693	3	Settings on Type 8692/8693: Input device address.	<i>BUS.COMM</i>	21.5.3
	4	Activate or deactivate safety position.		
	5	Configuration via the control (PROFIBUS DP Master): Configuration of the process values 1. <i>PDI</i> : Process data input 2. <i>PDO</i> : Process data output.	PROFIBUS DP Master by means of GSD file and special software	

Table 60: Start-up sequence for PROFIBUS DPV1

21.5.2 Safety settings if the bus fails

The position is approached which corresponds to the set-point value last transferred (default setting).
Other setting options (see chapter „21.5.3 BUS.COMM – Settings on Type 8692/8693“)

21.5.3 BUS.COMM – Settings on Type 8692/8693

Set the following menu options in the *BUS.COMM* menu for start-up of the PROFIBUS DPV1:

Baudrate Auto Set transmission speed (9.6 kBit/s...12 MBit/s)
Note: A device restart will be required after a change.

Address 0 Enter a device address (value between 0 and 126)

BUS FAIL Activate or deactivate approach of the safety position

Selection **SafePos off** – The actuator remains in the position which corresponds to the set-point value last transferred (default setting).

Selection **SafePos on** – If there is a fault in the bus communication, the behavior of the actuator depends on the activation of the *SAFEPOS* auxiliary function. See chapter „16.1.13 *SAFEPOS* – Inputting the safety position“.

SAFEPOS activated: The actuator moves to the safety position which is specified in the *SAFEPOS* auxiliary function.

SAFEPOS deactivated: The actuator moves to the safety end position which it would assume if the electrical and pneumatic auxiliary power failed. See chapter „10.8 Safety end positions after failure of the electrical or pneumatic auxiliary power“

Object Route Fct Activate or deactivate Object Route Function ORF (from software version B.11.00.00)

Selection **Off** – No access to individual objects in the büS network (default setting).

Selection **On** – Allows access to individual objects in the büS network (see document *Fieldbus Description: Communication, running cyclical commands, access to büS objects*)

21.6 Bus status display

The bus status is indicated on the display on the device.

Display	Device status	Explanation	Troubleshooting
BUS offline is displayed approx. every 3 seconds	offline	Device is not connected to the bus	<ul style="list-style-type: none"> • Check bus connection including plug assignment. • Check operating voltage and bus connection of the other nodes.

Table 61: Bus status display; PROFIBUS DPV1

22 MAINTENANCE AND TROUBLESHOOTING

22.1 Safety instructions



WARNING

Risk of injury from improper maintenance work.

- ▶ Maintenance may be carried out only by trained technicians and with the appropriate tools.
- ▶ Secure system against unintentional activation.
- ▶ Following maintenance, ensure a controlled restart.

22.2 Maintenance

If these instructions are followed for operation, Type 8692, 8693 is maintenance-free.

22.3 Fault messages

Display	Causes of fault	Corrective action
	Minimum input value has been reached.	Do not reduce value further.
	Maximum input value has been reached.	Do not increase value further.
<i>CMD error</i>	Signal fault Set-point value position controller	Check signal.
<i>SP error</i>	Signal fault Set-point value process controller.	Check signal.
<i>PV error</i>	Signal fault Actual value process controller.	Check signal.
<i>PT100 error</i>	Signal fault Actual value Pt 100.	Check signal.
<i>invalid code</i>	Incorrect access code.	Enter correct access code.
<i>EEPROM fault</i>	EEPROM defective.	Not possible, replace device.
<i>Puck weak</i>	Puck signal too weak	Check that the puck is mounted correctly and sitting on the guide rail
<i>WMS error</i>	Position sensor is not detected. Position sensor defective.	Check the wiring of the position sensor Not possible, replace position sensor or device.

Table 62: General fault messages

22.3.1 Error and warning messages while the *X.TUNE* function is running

Display	Causes of error	Remedial action
<i>TUNE</i> <i>err/break</i>	Manual termination of self-parameterization by pressing the EXIT key.	
<i>X.TUNE</i> locked	The <i>X.TUNE</i> function is blocked	Input access code
<i>X.TUNE</i> <i>ERROR 1</i>	No compressed air connected	Connect compressed air
<i>X.TUNE</i> <i>ERROR 2</i>	Compressed air failed during Autotune (<i>X.TUNE</i>).	Check compressed air supply
<i>X.TUNE</i> <i>ERROR 3</i>	Actuator or control system deaeration side leaking	Not possible, device defective
<i>X.TUNE</i> <i>ERROR 4</i>	Control system aeration side leaking	Not possible, device defective
<i>X.TUNE</i> <i>ERROR 6</i>	The end positions for <i>POS-MIN</i> and <i>POS-MAX</i> are too close together	Check compressed air supply
<i>X.TUNE</i> <i>ERROR 7</i>	Incorrect assignment <i>POS-MIN</i> and <i>POS-MAX</i>	To determine <i>POS-MIN</i> and <i>POS-MAX</i> , move the actuator in the direction indicated on the display.

Table 63: Error and warning message on *X.TUNE*

22.3.2 Error messages while the *P.Q'LIN* function is running

Display	Cause of fault	Remedial action
<i>TUNE</i> <i>err/break</i>	Manual termination of linearization by pressing the EXIT key.	
<i>P.Q LIN</i> <i>ERROR 1</i>	No supply pressure connected. No change to process variable.	Connect supply pressure. Check process and, if required, switch on pump or open the shut-off valve. Check process sensor.
<i>P.Q LIN</i> <i>ERROR 2</i>	Current node of the valve stroke was not reached, as <ul style="list-style-type: none"> • Supply pressure failed during <i>P.Q'LIN</i>. • Autotune (<i>X.TUNE</i>) was not run. 	Check compressed air supply. Run Autotune (<i>X.TUNE</i>).

Table 64: Error message on *P.Q'LIN*; process controller Type 8693

22.3.3 Error messages while the *P.TUNE* function is running

Display	Cause of fault	Remedial action
<i>TUNE</i> <i>err/break</i>	Manual termination of linearization by pressing the EXIT key.	
<i>P.TUNE</i> <i>ERROR 1</i>	No supply pressure connected. No change to process variable.	Connect supply pressure. Check process and, if required, switch on pump or open the shut-off valve. Check process sensor.

Table 65: Error message on *P.TUNE*; process controller Type 8693

For Ethernet/IP, PROFINET, Modbus TCP, PROFIBUS DPV1

Display (is displayed approx. every 3 seconds)	Device state	Explanation	Troubleshooting
<i>BUS no connection</i>	Online, No connection to the master.	Device is connected correctly to the bus, the network access procedure has ended without faults, however there is no established connection to the master.	<ul style="list-style-type: none"> • New connection established by master.
<i>BUS critical err</i>	Critical bus fault.	Other device with the same address in the network. <i>BUS offline</i> due to communication problems.	<ul style="list-style-type: none"> • Change address of the device and restart device. • Fault analysis in the network with a bus monitor.

Table 66: Fault message Ethernet/IP, PROFINET, Modbus TCP, PROFIBUS DPV1

For bÜS device

Display (is displayed approx. every 3 seconds)	Device state	Explanation	Troubleshooting
<i>BUS no connection</i>	Online, No connection to the master.	Device is connected correctly to the bus, the network access procedure has ended without faults, however there is no established connection to the master.	<ul style="list-style-type: none"> • New connection established by master.
<i>BUS critical err</i>	Critical bus fault.	Other device with the same address in the network. <i>BUS offline</i> due to communication problems.	<ul style="list-style-type: none"> • Change address of the device and restart device. • Fault analysis in the network with a bus monitor.
<i>Partner not found</i>	Partner not found	A configured partner (Producer) cannot be found.	<ul style="list-style-type: none"> • Check that the configured partner is switched on and connected to the bÜS network. • Check the bÜS mapping using the Communicator.

Table 67: Fault message bÜS device

22.4 Malfunctions

Problem	Possible causes	Corrective action
<p>$POS = 0$ (when $CMD > 0\%$) or $POS = 100\%$, (when $CMD < 100\%$).</p> <p>$PV = 0$ (when $SP > 0$) or $PV = PV$ (when $SP > SP$).</p>	<p>Sealing function (<i>CUTOFF</i>) is unintentionally activated.</p>	<p>Deactivate sealing function.</p>
<p>Applies only to devices with digital output:</p> <p>Digital output does not switch.</p>	<p>Digital output:</p> <ul style="list-style-type: none"> • Current > 100 mA • Short-circuit 	<p>Check digital output connection.</p>
<p>Applies only to devices with process controller:</p> <p>Device is not operating as a controller, despite correctly implemented settings.</p>	<p><i>P.CONTROL</i> menu option is in the main menu. The device is therefore operating as a process controller and expects a process actual value at the corresponding input.</p>	<p>Remove <i>P.CONTROL</i> menu option from the main menu. See chapter 16.1.2</p>

Table 68: Other malfunctions

23 ACCESSORIES

Accessories	Order number
Connection cable with M12 socket, 8-pin, (length 5 m)	919267
Connection cable with M12 socket, 4-pin, (length 5 m)	918038
Connection cable with M8 socket, 4-pin, (length 5 m)	264602
Connection cable with M12 circular connector, 4-pin, (length 5 m) D-coded	on request
USB bÜS interface set:	
bÜS service interface (bÜS stick + 0.7 m cable with M12 plug)	772551
bÜS adapter for bÜS service interface (M12 to bÜS service interface micro USB)	773254
bÜS cable extensions from M12 plug to M12 socket	
Connection cable, length 1 m	772404
Connection cable, length 3 m	772405
Connection cable, length 5 m	772406
Connection cable, length 10 m	772407
Bürkert Communicator	Information at country.burkert.com
Screwdriver for opening/closing the transparent cap	674077

Table 69: Accessories

23.1 Communications software

The PC operating program "Bürkert Communicator" is designed for communication with devices from the Bürkert position controller family.



A detailed description for installing and operating the software can be found in the associated operating instructions.

23.2 Download

Download the software from: country.burkert.com

23.3 USB interface

The PC requires a USB interface for communication with the devices, also a USB-bÜS interface set (see „Table 69: Accessories“).

Data is transmitted according to CANopen specification.

24 REMOVAL OF TYPE 8692, 8693

! WARNING

Risk of injury from improper disassembly.

- ▶ Removal may be carried out by authorized technicians only and using the appropriate tools.

Risk of injury from unintentional activation of the system and uncontrolled restart.

- ▶ Secure system against unintentional activation.
- ▶ Following disassembly, ensure a controlled restart.

Sequence:

1. Remove the pneumatic connections.
2. Disconnect the electrical connection.
3. Remove Type 8692, 8693.

24.1 Disconnecting the pneumatic connections

! DANGER

Risk of injury from high pressure.

- ▶ Before loosening lines and valves, turn off the pressure and vent the lines.

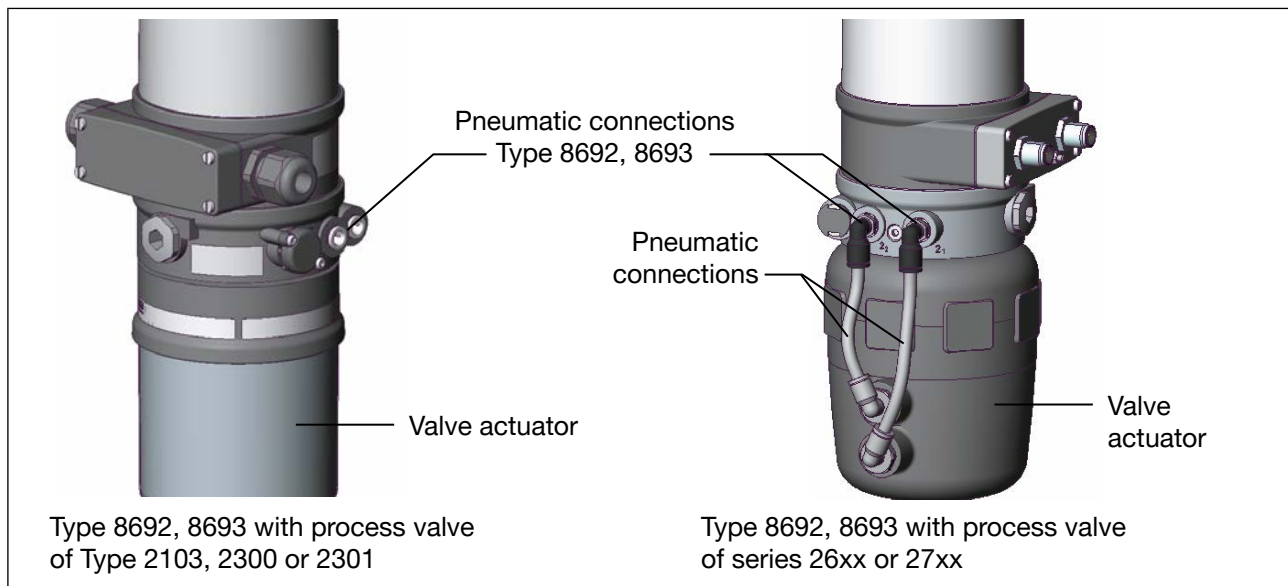


Figure 81: Removing the pneumatic connections

→ Disconnect the pneumatic connections to Type 8692, 8693.

For process valves belonging to series 26xx and 27xx:

→ Disconnect the pneumatic connections to the actuator.

24.2 Disconnecting electrical connections

⚠ DANGER

Risk of injury due to electric shock.

- ▶ Before reaching into the device or the equipment, switch off the power supply and secure to prevent reactivation.
- ▶ Observe the applicable accident prevention regulations and safety regulations for electrical equipment.

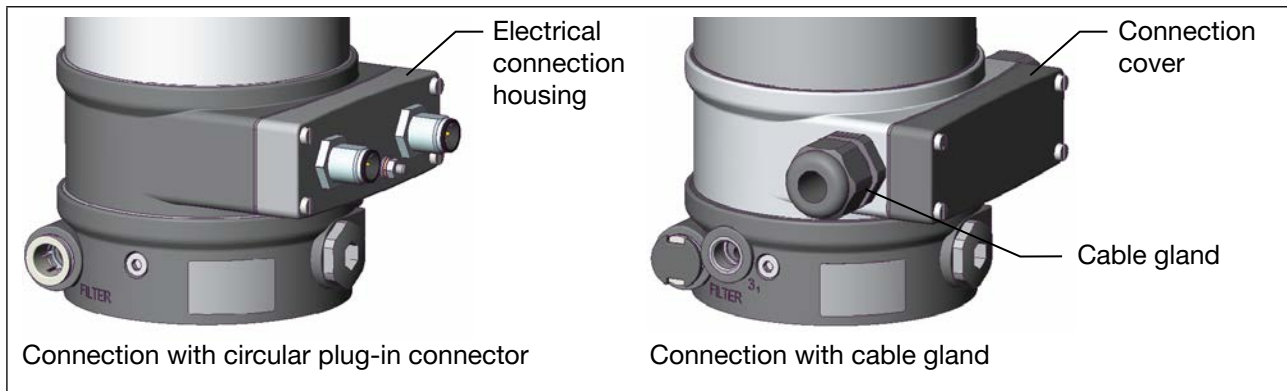


Figure 82: Disconnecting electrical connections

Connection with circular plug-in connector:

- Remove circular plug-in connector.

Connection with cable gland:

- Loosen the 4 screws of the connection cover and remove the cover.
- Loosen the screw-type terminals and pull out the cables.

24.3 Removing Type 8692, 8693

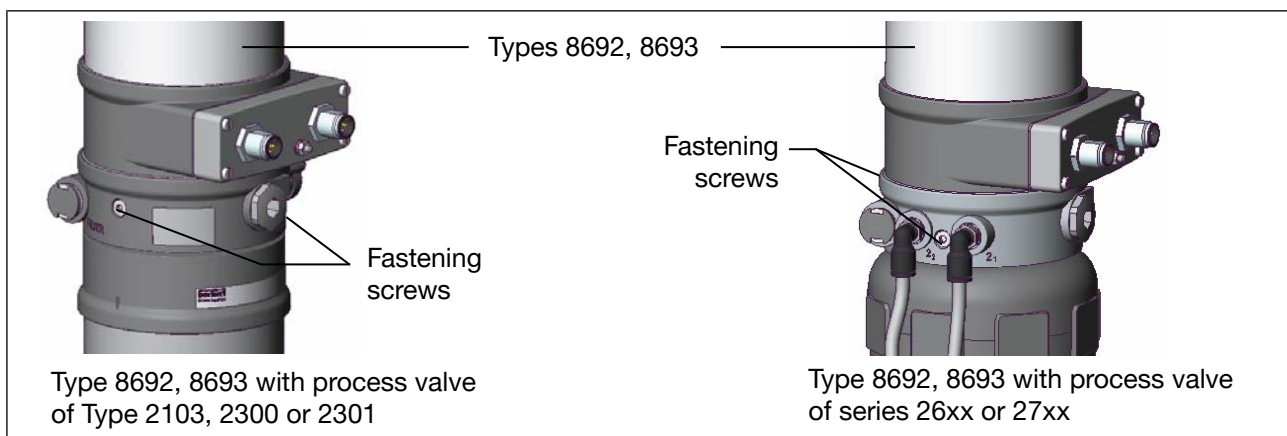


Figure 83: Disconnecting electrical connections

- Release the fastening screws.
- Remove Type 8692, 8693.

25 PACKAGING AND TRANSPORT

NOTE

Transport damages.

Inadequately protected equipment may be damaged during transport.

- ▶ During transportation protect the device against wet and dirt in shock-resistant packaging.
- ▶ Avoid exceeding or dropping below the allowable storage temperature.

26 STORAGE

NOTE

Incorrect storage may damage the device.

- ▶ Store the device in a dry and dust-free location.
- ▶ Storage temperature -20...+65 °C (-40...158 °F).

27 DISPOSAL



- ▶ Follow national regulations regarding disposal and the environment.
- ▶ Collect electrical and electronic devices separately and dispose of them as special waste.

Further information country.burkert.com.

28 SUPPLEMENTARY INFORMATION

28.1 Selection criteria for continuous valves

The following criteria are crucial for optimum control behavior and to ensure that the required maximum flow is reached:

- the correct selection of the flow coefficient which is defined primarily by the orifice of the valve;
- close coordination between the nominal width of the valve and the pressure conditions in consideration of the remaining flow resistance in the equipment.

Design guidelines can be given on the basis of the flow coefficient (k_v value). The k_v value refers to standardised conditions with respect to pressure, temperature and media properties.

The k_v value describes the flow rate of water through a component in m^3/h at a pressure difference of $\Delta p = 1$ bar and $T = 20\text{ }^\circ\text{C}$.

The “ k_{vS} value” is also used for continuous valves. This indicates the k_v value when the continuous valve is fully open.

Depending on the specified data, it is necessary to differentiate between the two following cases when selecting the valve:

- a) The pressure values p_1 and p_2 , known before and after the valve, represent the required maximum flow-rate Q_{max} which is to be reached:

The required k_{vS} value is calculated as follows:

$$k_{vS} = Q_{\text{max}} \cdot \sqrt{\frac{\Delta p_0}{\Delta p}} \cdot \sqrt{\frac{\rho}{\rho_0}} \quad (1)$$

Meaning of the symbols:

k_{vS}	flow coefficient of the continuous valve when fully open [m^3/h]
Q_{max}	maximum volume flow rate [m^3/h]
Δp_0	= 1 bar; pressure loss on the valve according to the definition of the k_v value
ρ_0	= 1000 kg/m^3 ; density of water (according to the definition of the k_v value)
Δp	pressure loss on the valve [bar]
ρ	density of the medium [kg/m^3]

- b) The pressure values, known at the input and output of the entire equipment (p_1 and p_2), represent the required maximum flow-rate Q_{max} which is to be reached:

- 1st step: Calculate the flow coefficient of the entire equipment $k_{v\text{ges}}$ according to equation (1).
- 2nd step: Determine the flow-rate through the equipment without the continuous valve (e.g. by „short-circuiting“ the line at the installation location of the continuous valve).
- 3rd step: Calculate the flow coefficient of the equipment without the continuous valve ($k_{v\text{a}}$) according to equation (1).
- 4th step: Calculate the required k_{vS} value of the continuous valve according to equation (2):

$$k_{vS} = \sqrt{\frac{1}{\frac{1}{k_{v\text{ges}}^2} - \frac{1}{k_{v\text{a}}^2}}} \quad (2)$$



The k_{VS} value of the continuous valve should have at least the value which is calculated according to equation (1) or (2) which is appropriate to the application, however it should never be far above the calculated value.

The rule of thumb "slightly higher is never harmful" often used for switching valves may greatly impair the control behavior of continuous valves!

The upper limit for the k_{VS} value of the continuous valve can be specified in practice via the so-called valve authority Ψ :

$$\Psi = \frac{(\Delta p)_{v_0}}{(\Delta p)_0} = \frac{k_{va}^2}{k_{va}^2 + k_{vs}^2} \quad (3)$$

$(\Delta p)_{v_0}$ Pressure drop over the fully opened valve

$(\Delta p)_0$ Pressure drop over the entire equipment



If the valve authority $\Psi < 0.3$ the continuous valve has been oversized.

When the continuous valve is fully open, the flow resistance in this case is significantly less than the flow resistance of the remaining fluid components in the equipment. This means that the valve position predominates in the operating characteristic in the lower opening range only. For this reason the operating characteristic is highly deformed.

By selecting a progressive (equal percentage) transfer characteristic between position set-point value and valve stroke, this can be partially compensated and the operating characteristic linearised within certain limits. However, the valve authority Ψ should be > 0.1 even if a correction characteristic is used.

The control behavior (control quality, transient time) depends greatly on the working point if a correction characteristic is used.

28.2 Properties of PID Controllers

A PID controller has a proportional, an integral and a differential portion (P, I and D portion).

28.2.1 P-portion

Function:

$$Y = K_p \cdot X_d$$

K_p is the proportional coefficient (proportional gain). It is the ratio of the adjusting range ΔY to the proportional range ΔX_d .

Characteristic and step response of the P portion of a PID controller

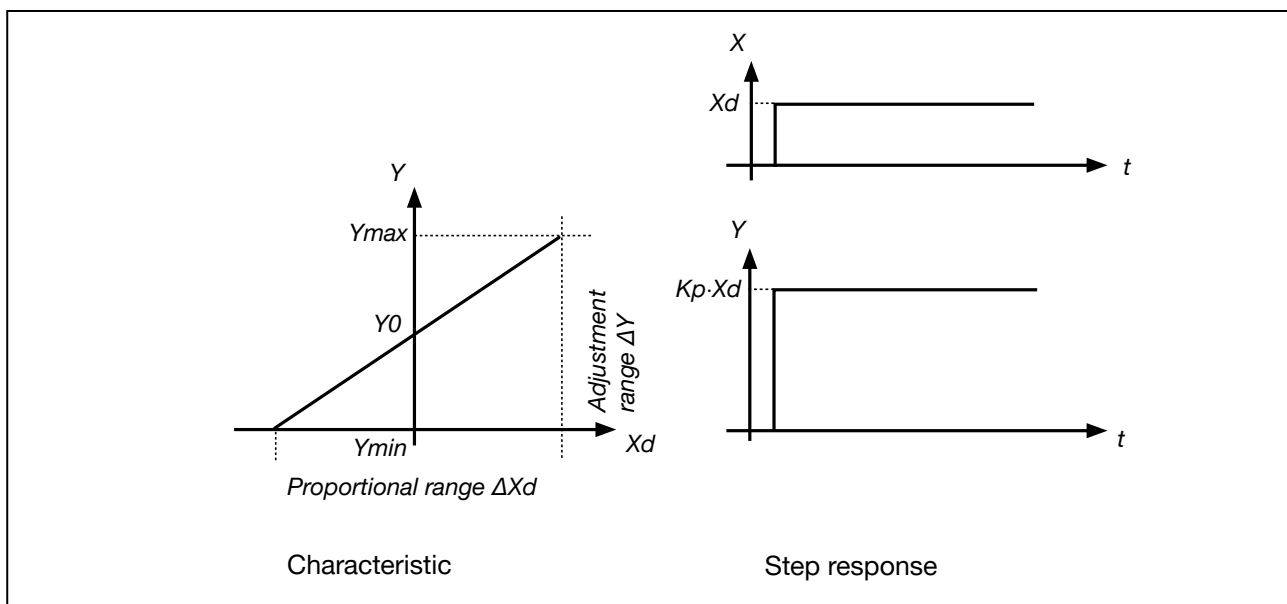


Figure 84: Characteristic and step response of the P portion of a PID controller

Properties

In theory a pure P-controller functions instantaneously, i.e. it is quick and therefore dynamically favorable. It has a constant control difference, i.e. it does not fully correct the effects of malfunctions and is therefore statically relatively unfavorable.

28.2.2 I-portion

Function:

$$Y = \frac{1}{T_i} \int X \, dt \quad (5)$$

T_i is the integral action time or actuating time. It is the time which passes until the actuating variable has run through the whole adjustment range.

Characteristic and step response of the I portion of a PID controller

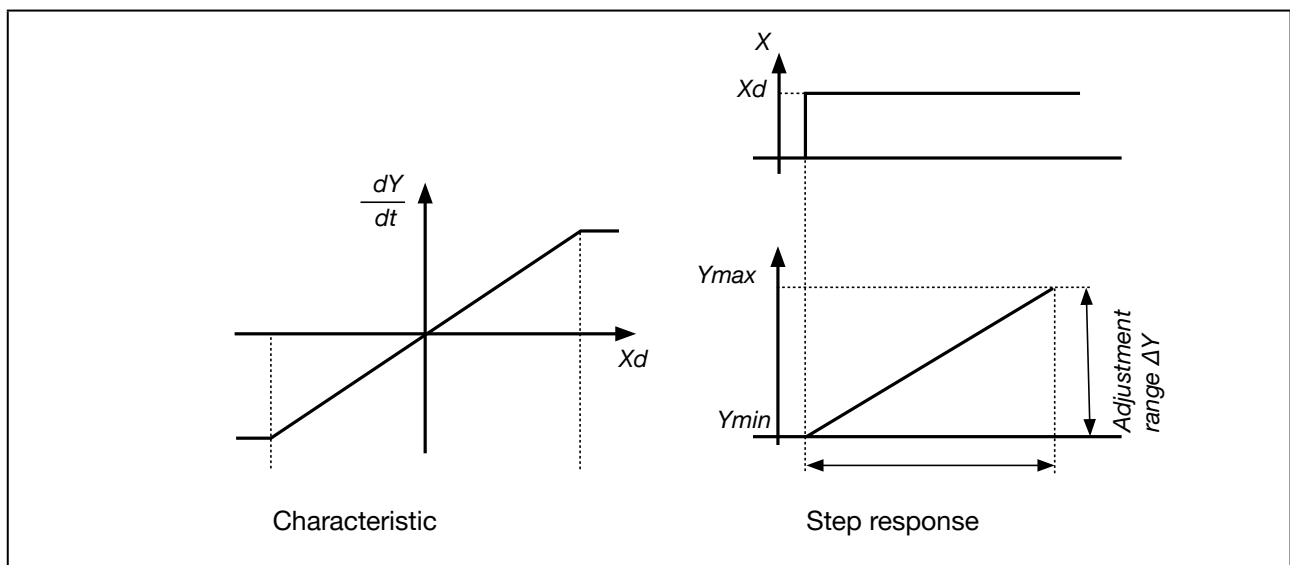


Figure 85: Characteristic and step response of the I portion of a PID controller

Properties

A pure I-controller completely eliminates the effects of any malfunctions which occur. It therefore has a favorable static behavior. On account of its final actuating speed control it operates slower than the P-controller and has a tendency to oscillate. It is therefore dynamically relatively unfavorable.

28.2.3 D-portion

Function:

$$Y = K_d \cdot \frac{dX}{dt} \quad (6)$$

K_d is the derivative action coefficient. The larger K_d is, the greater the D-effect is.

Characteristic and step response of the D portion of a PID controller

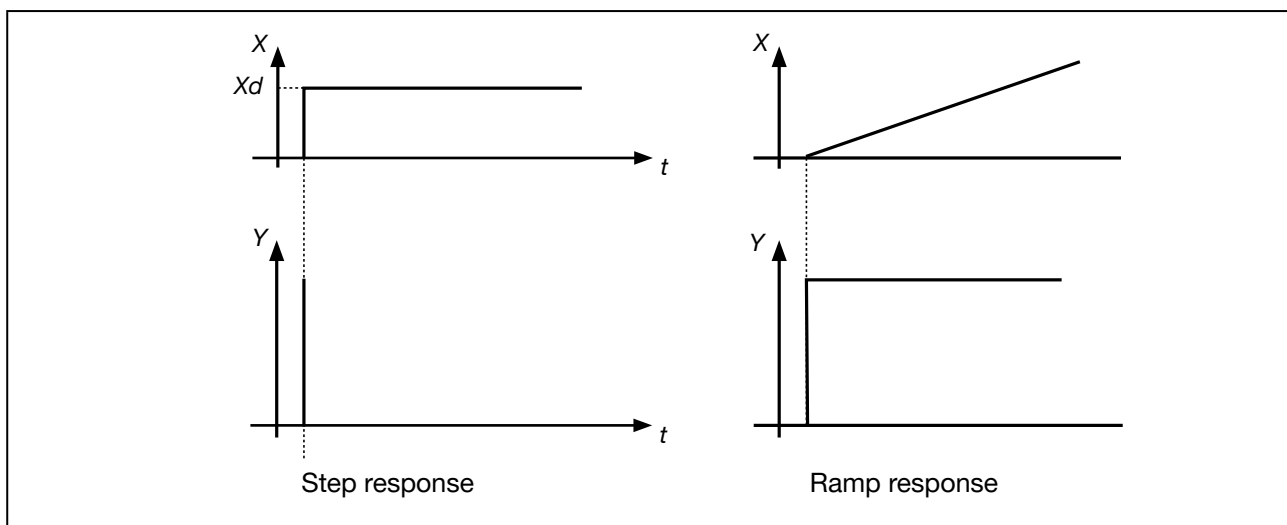


Figure 86: Characteristic and step response of the D portion of a PID controller

Properties

A controller with a D portion responds to changes in the control variable and may therefore reduce any control differences more quickly.

28.2.4 Superposition of P, I and D Portions

Function:

$$Y = K_p \cdot X_d + \frac{1}{T_i} \int X_d dt + K_d \frac{dX_d}{dt} \quad (7)$$

Where $K_p \cdot T_i = T_n$ and $K_d/K_p = T_v$ the **function of the PID controller** is calculated according to the following equation:

$$Y = K_p \cdot \left(X_d + \frac{1}{T_n} \int X_d dt + T_v \frac{dX_d}{dt} \right) \quad (8)$$

- K_p Proportional coefficient / proportional gain
- T_n Reset time
(Time which is required to obtain an equally large change in the actuating variable by the I portion, as occurs due to the P portion)
- T_v Derivative time
(Time by which a certain actuating variable is reached earlier on account of the D portion than with a pure P-controller)

Step response and ramp response of the PID controller

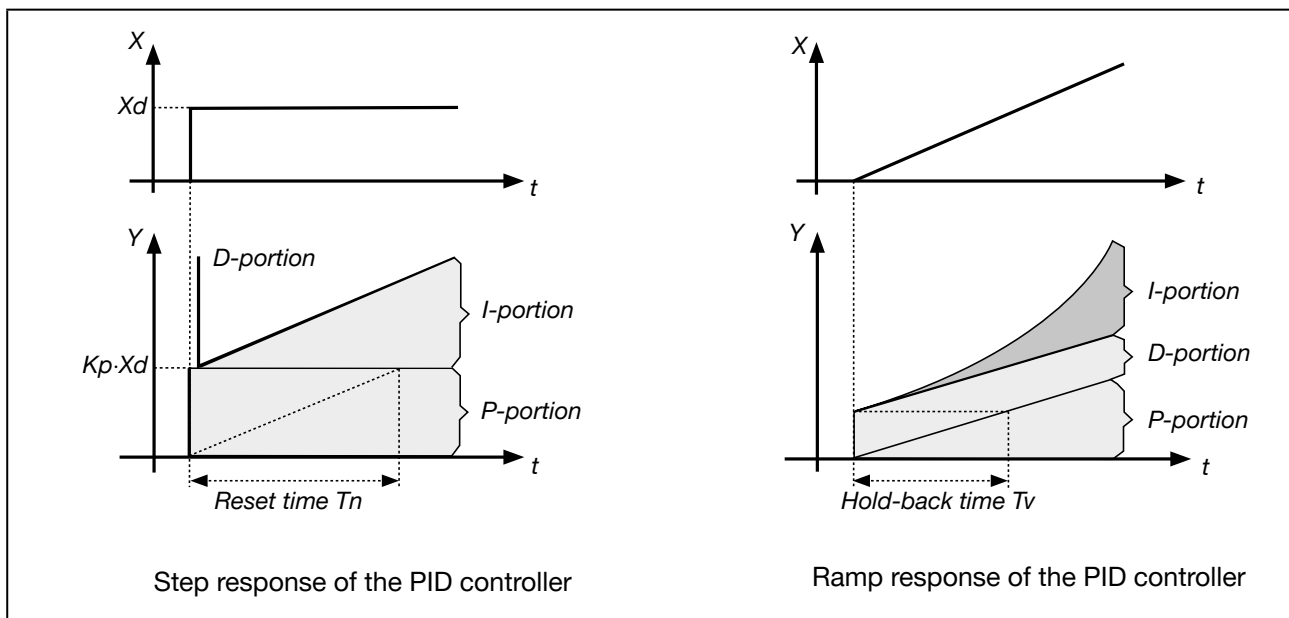


Figure 87: Characteristic of step response and ramp response of PID controller

MAN 1000327408 EN Version: N Status: RL (released | freigegeben) printed: 01.09.2023

28.2.5 Implemented PID controller

28.2.5.1. D Portion with delay

In the process controller Type 8693 the D portion is implemented with a delay T.

Function:

$$T \cdot \frac{dY}{dt} + Y = K_d \cdot \frac{dX_d}{dt} \quad (9)$$

Superposition of P, I and DT Portions

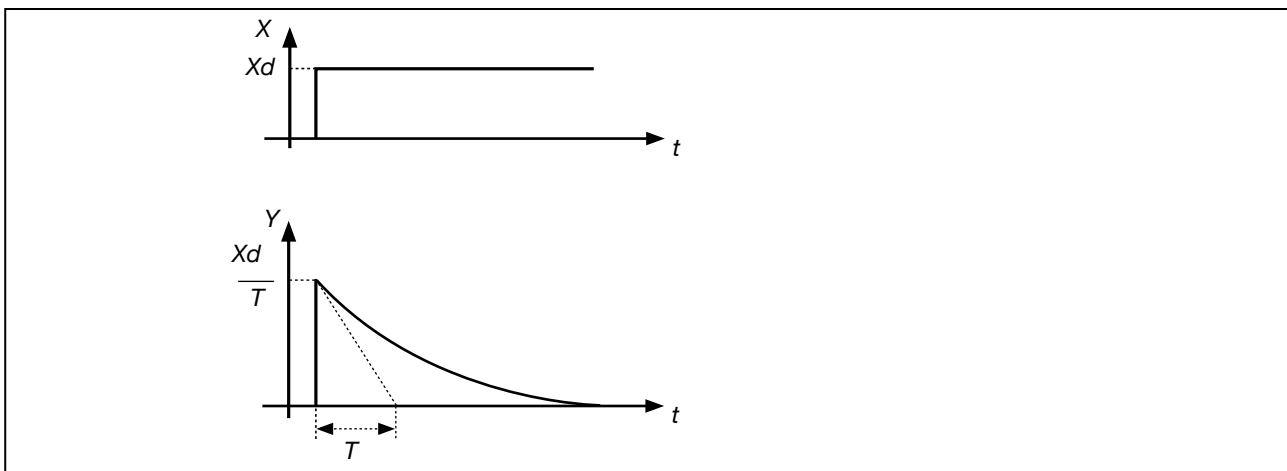


Figure 88: Characteristic of superposition of P, I and DT Portions

28.2.5.2. Function of the real PID controller

$$T \cdot \frac{dY}{dt} + Y = K_p \left(X_d + \frac{1}{T_n} \int X_d dt + T_v \frac{dX_d}{dt} \right) \quad (10)$$

Superposition of P, I and DT Portions

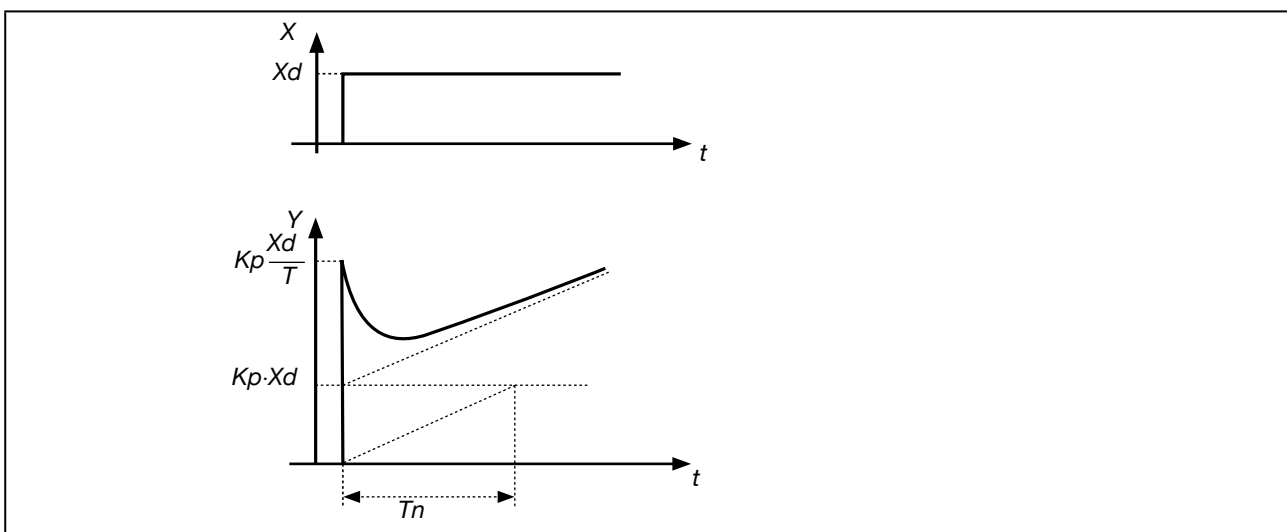


Figure 89: Characteristic of step response of the real PID controller

28.3 Adjustment rules for PID Controllers

The control system Type 8693 features a self-optimization function for the structure and parameters of the integrated process controller. The determined PID parameters can be seen via the operating menu and re-optimized at will for an empirical path.

The regulatory literature includes a series of adjustment rules which can be used in experimental ways to determine a favorable setting for the controller parameters. To avoid incorrect settings, always observe the conditions under which the particular adjustment rules have been drawn up. Apart from the properties of the control process and the controller itself, the aspect whether a change in the disturbance variable or command variable is to be corrected plays a role.

28.3.1 Adjustment rules according to Ziegler and Nichols (oscillation method)

With this method the controller parameters are adjusted on the basis of the behavior of the control circuit at the stability limit. The controller parameters are first adjusted so that the control circuit starts to oscillate. The occurring critical characteristic values suggest a favorable adjustment of the controller parameters. A prerequisite for the application of this method of course is that the control circuit is oscillated.

Procedure

- Set controller as P-controller (i.e. $T_n = 999$, $T_v = 0$), first select a low value for K_p
- Set required set-point value
- Increase K_p until the control variable initiates an undamped continuous oscillation.

The proportionality coefficient (proportional gain) set at the stability limit is designated as K_{krit} . The resulting oscillation duration is designated as T_{krit} .

Progress of the control variable at the stability limit

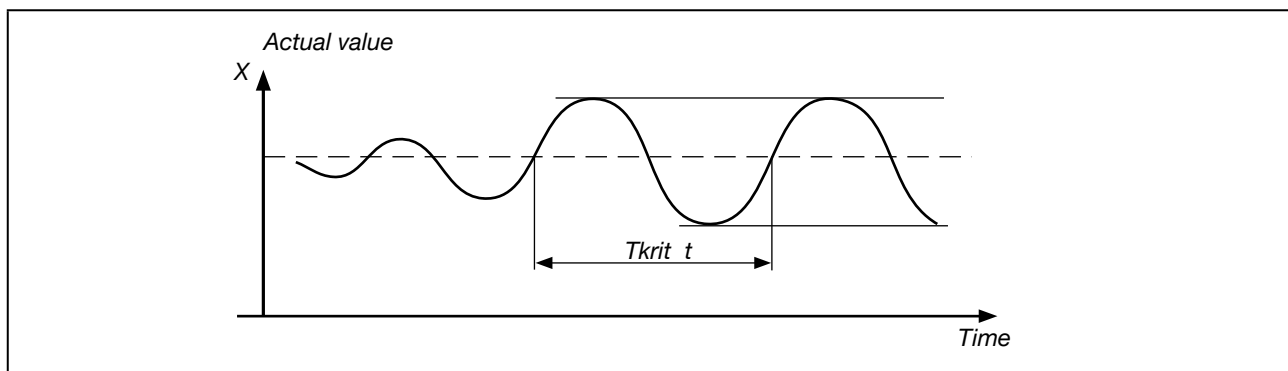


Figure 90: Progress of the control variable PID

The controller parameters can then be calculated from K_{krit} and T_{krit} according to the following table.

Adjustment of the parameters according to Ziegler and Nichols

Controller type	Adjustment of the parameters		
P controller	$K_p = 0.5 K_{krit}$	-	-
PI controller	$K_p = 0.45 K_{krit}$	$T_n = 0.85 T_{krit}$	-
PID controller	$K_p = 0.6 K_{krit}$	$T_n = 0.5 T_{krit}$	$T_v = 0.12 T_{krit}$

Table 70: Adjustment of the parameters according to Ziegler and Nichols

The adjustment rules of Ziegler and Nichols have been determined for P-controlled systems with a time delay of the first order and dead time. However, they apply only to controllers with a disturbance reaction and not to those with a reference reaction.

28.3.2 Adjustment rules according to Chien, Hrones and Reswick (actuating variable jump method)

With this method the controller parameters are adjusted on the basis of the transient behavior of the controlled system. An actuating variable jump of 100% is output. The times T_u and T_g are derived from the progress of the actual value of the control variable.

Progress of the control variable following an actuating variable jump ΔY

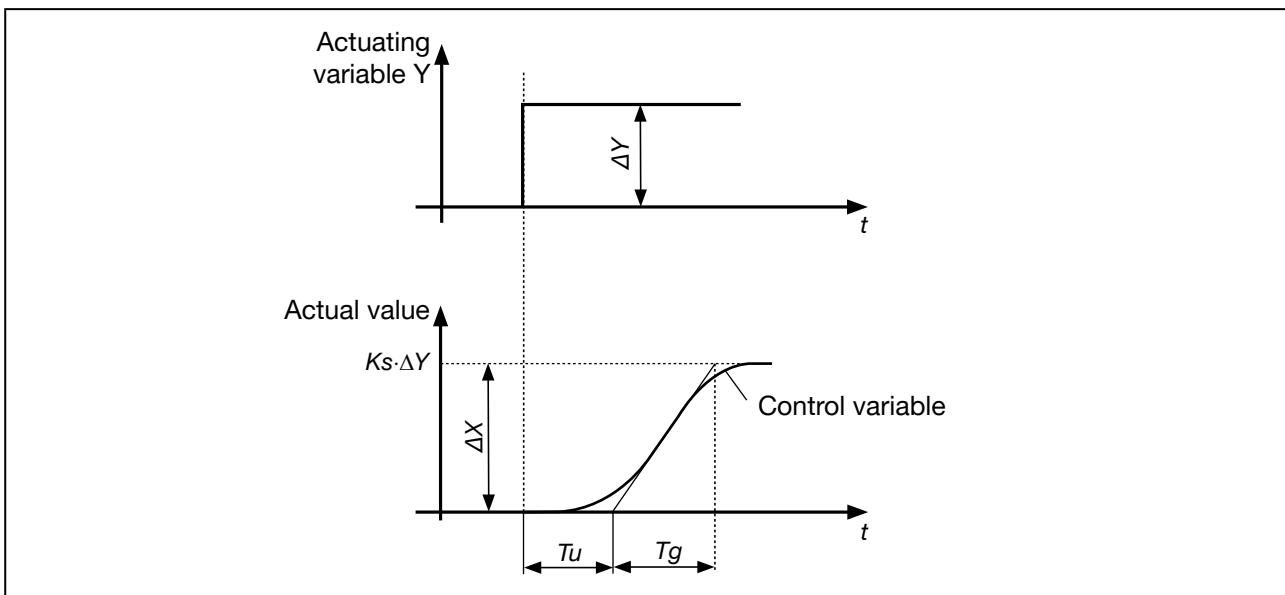


Figure 91: Progress of the control variable, actuating variable jump

Procedure

- Switch controller to MANUAL (MANU) operating state
- Output the actuating variable jump and record control variable with a recorder
- If progresses are critical (e.g. danger of overheating), switch off promptly.



Note that in thermally slow systems the actual value of the control variable may continue to rise after the controller has been switched off.

In the following [Table 71](#) the adjustment values have been specified for the controller parameters, depending on T_u , T_g and K_s for reference and disturbance reaction, as well as for an aperiodic control process and a control process with a 20% overshoot. They apply to controlled systems with P-behavior, with dead time and with a delay of the first order.

Adjustment of the parameters according to Chien, Hrones and Reswick

Controller type	Adjustment of the parameters			
	for aperiodic control process (0% overshoot)		for control process with 20% overshoot	
	Reference	Malfunction	Reference	Malfunction
P controller	$K_p = 0,3 \cdot \frac{T_g}{T_u \cdot K_s}$	$K_p = 0,3 \cdot \frac{T_g}{T_u \cdot K_s}$	$K_p = 0,7 \cdot \frac{T_g}{T_u \cdot K_s}$	$K_p = 0,7 \cdot \frac{T_g}{T_u \cdot K_s}$
PI controller	$K_p = 0,35 \cdot \frac{T_g}{T_u \cdot K_s}$ $T_n = 1,2 \cdot T_g$	$K_p = 0,6 \cdot \frac{T_g}{T_u \cdot K_s}$ $T_n = 4 \cdot T_u$	$K_p = 0,6 \cdot \frac{T_g}{T_u \cdot K_s}$ $T_n = T_g$	$K_p = 0,7 \cdot \frac{T_g}{T_u \cdot K_s}$ $T_n = 2,3 \cdot T_u$
PID controller	$K_p = 0,6 \cdot \frac{T_g}{T_u \cdot K_s}$ $T_n = T_g$ $T_v = 0,5 \cdot T_u$	$K_p = 0,95 \cdot \frac{T_g}{T_u \cdot K_s}$ $T_n = 2,4 \cdot T_u$ $T_v = 0,42 \cdot T_u$	$K_p = 0,95 \cdot \frac{T_g}{T_u \cdot K_s}$ $T_n = 1,35 \cdot T_g$ $T_v = 0,47 \cdot T_u$	$K_p = 1,2 \cdot \frac{T_g}{T_u \cdot K_s}$ $T_n = 2 \cdot T_u$ $T_v = 0,42 \cdot T_u$

Table 71: Adjustment of the parameters according to Chien, Hrones and Reswick

The amplification factor K_s of the controlled system is calculated as follows:

$$K_s = \frac{\Delta X}{\Delta Y} \quad (11)$$

29 TABLES FOR CUSTOMER-SPECIFIC SETTINGS

29.1 Table for your settings on the positioner type 8692

29.1.1 Settings of the freely programmable characteristic

Node (position set-point value as %)	Valve stroke [%]			
	Date:	Date:	Date:	Date:
0				
5				
10				
15				
20				
25				
30				
35				
40				
45				
50				
55				
60				
65				
70				
75				
80				
85				
90				
95				
100				

MAN 1000327408 EN Version: N Status: RL (released | freigegeben) printed: 01.09.2023

