



### Solenoids with Kick and Drop

- Two windings encapsulated in one coil with epoxy
- Inrush power increases performance and differential pressure range for small installation volumes
- Holding power reduces to less than 1 W with over 80 % energy saved
- Less heating reduces calcification and increases service life
- Internal electronics assembly covers direct and alternating voltage with frequencies 50 Hz and 60 Hz

Product variants described in the data sheet may differ from the product presentation and description.

#### Can be combined with

	<b>Type 6013</b> Plunger valve 2/2-way direct-acting	▶
	<b>Type 6014</b> Plunger valve 3/2-way direct-acting	▶
	<b>Type 6027</b> Direct-acting 2/2-way plunger valve	▶
	<b>Type 6213</b> Servo-assisted 2/2-way diaphragm valve	▶
	<b>Type 6281</b> Servo-assisted 2/2-way diaphragm valve	▶
	<b>Type 5404</b> Servo-assisted 2/2-way piston valve	▶
	<b>Type 6240</b> Servo-assisted 2/2-way piston valve	▶

#### Type description

The Kick and Drop variants of the AC10 and AC19 coil types use two windings in one solenoid. Thanks to an increased inrush power for the first winding, the switchable pressure range is increased as installation volumes stay the same. The second winding is switched in series after 500 ms. Thanks to this reduced holding power, energy is saved and coil heating is reduced.

DTS 1000579974 EN Version: E Status: RL (released | freigegeben | validé) printed: 28.03.2024

## Table of contents

<b>1. General technical data</b>	<b>3</b>
<b>2. Circuit functions</b>	<b>4</b>
<b>3. Approvals and conformities</b>	<b>4</b>
3.1. General notes.....	4
3.2. Conformity .....	4
3.3. Standards.....	4
3.4. Explosion protection .....	5
3.5. North America (USA/Canada) .....	5
<b>4. Materials</b>	<b>6</b>
4.1. Bürkert resistApp .....	6
4.2. Material specifications .....	6
<b>5. Dimensions</b>	<b>7</b>
5.1. Standard version AC10 .....	7
5.2. Standard version AC19 .....	7
<b>6. Performance specifications</b>	<b>8</b>
6.1. Temperature diagram .....	8
Maximum ambient temperature .....	8
Maximum surface temperature .....	8
<b>7. Ordering information</b>	<b>9</b>
7.1. Bürkert eShop .....	9
7.2. Bürkert product filter .....	9
7.3. Ordering chart for Kick and Drop UL recognized (cURus) coil sets.....	9
7.4. Ordering chart for Type 6013 with Kick and Drop UL recognized (cURus) coil.....	10
7.5. Ordering chart for Type 6014 with Kick and Drop UL recognized (cURus) coil.....	11
7.6. Ordering chart for Type 6026 with Kick and Drop UL recognized (cURus) coil.....	12
7.7. Ordering chart for Type 6027 with Kick and Drop UL recognized (cURus) coil.....	13
7.8. Ordering chart for Type 6213 with Kick and Drop UL recognized (cURus) coil.....	14
7.9. Ordering chart for Type 6281 with Kick and Drop UL recognized (cURus) coil.....	15
7.10. Ordering chart for Type 5404 with Kick and Drop UL recognized (cURus) coil.....	16
7.11. Ordering chart for Type 6240 with Kick and Drop UL recognized (cURus) coil.....	17
7.12. Ordering chart for Type 6407 with Kick and Drop UL recognized (cURus) coil.....	18
7.13. Ordering chart for accessories.....	19
Cable plug Type 2518, form A according to DIN EN 175301 - 803 .....	19
Cable plug Type 2509, form A according to DIN EN 175301 - 803 .....	19

DTS 1000579974 EN Version: E Status: RL (released | freigegeben | validé) printed: 28.03.2024

## 1. General technical data

Product properties		
Dimensions	Further information can be found in chapter <a href="#">“5. Dimensions” on page 7.</a>	
<b>Material<sup>1)</sup></b>		
Seal	FKM	
Coil	Epoxy	
Circuit function	A, B, C and D Further information can be found in chapter <a href="#">“2. Circuit functions” on page 4.</a>	
Thermal insulation class of solenoid coil	Epoxy coil class H	
Performance data		
<b>Switching frequency</b>		
AC10	Max. 30 cycles/min	
AC19	Max. 30 cycles/min	
Electrical data		
Operating voltage	24 V/50...60 Hz and 24 V/DC, 110...120 V/50...60 Hz, 230...240 V/50...60 Hz	
Single valve duty cycle	100 % continuous operation	
Voltage tolerance	± 10 %	
Process/Port connection & communication		
Electrical connection	<ul style="list-style-type: none"> <li>• Plug contacts according to DIN EN 175 301 - 803 form A for cable plug <b>Type 2518</b> ▶. Further information can be found in chapter <a href="#">“Cable plug Type 2518, form A according to DIN EN 175301 - 803” on page 19.</a></li> <li>• Plug contacts according to DIN EN 175 301 - 803 form A for cable plug <b>Type 2509</b> ▶. Further information can be found in chapter <a href="#">“Cable plug Type 2509, form A according to DIN EN 175301 - 803” on page 19.</a></li> <li>• ATEX/IECEx version with cable or terminal box at AC19</li> </ul>	
Approvals and conformities		
Degree of protection	IP65 with cable plug IP67 with cable plug Type 2518 (for possible versions see data sheet <b>Type 2518</b> ▶)	
Explosion protection	Further information can be found in chapter <a href="#">“3.4. Explosion protection” on page 5.</a>	
North America (USA/Canada)	Further information can be found in chapter <a href="#">“3.5. North America (USA/Canada)” on page 5.</a>	
Environment and installation		
<b>Ambient temperature<sup>2)</sup></b>		
<b>AC10</b>	<b>30 switching cycles/min</b>	<b>1 switching cycle/min</b>
12/0.6 W	Max. 158 °F	Max. 185 °F
20/2.0 W	Max. 158 °F	Max. 185 °F
65/7.0 W	Max. 131 °F	Max. 158 °F
<b>AC19</b>	<b>30 switching cycles/min</b>	<b>1 switching cycle/min</b>
44/6.5 W	Max. 158 °F	Max. 185 °F standard/158 °F ATEX cat. 2
85/8.5 W	Max. 131 °F	Max. 158 °F

1.) Because of the overmounted coil system, the following materials are not wetted by the medium.

2.) The temperature specifications correspond to the specified switchable differential pressures. Higher temperatures are possible on request, depending on the differential pressure, duty cycle and number of switching cycles. Further information can be found in chapter [“6.1. Temperature diagram” on page 8.](#)

## 2. Circuit functions

Symbol	Description
	<b>Circuit function A (CF A)</b> 2/2-way solenoid valve Direct-acting Normally closed
	<b>Circuit function B (CF B)</b> 2/2-way solenoid valve Direct-acting Normally open
	<b>Circuit function C (CF C)</b> 3/2-way solenoid valve Direct-acting Normally closed
	<b>Circuit function D (CF D)</b> 3/2-way solenoid valve Direct-acting Normally open

## 3. Approvals and conformities

### 3.1. General notes

- The approvals and conformities listed below must be stated when making enquiries. This is the only way to ensure that the product complies with all required specifications.
- Not all available versions can be supplied with the below mentioned approvals or conformities.



### 3.2. Conformity

In accordance with the Declaration of Conformity, the product is compliant with the EU Directives.



### 3.3. Standards

The applied standards which are used to demonstrate compliance with the EU Directives are listed in the EU-Type Examination Certificate and/or the EU Declaration of Conformity.

3.4. Explosion protection

Approval	Description						
 	<p><b>Optional (valid for AC19 KD coils): Explosion protection according to category 2 (zone 1/21)</b></p> <p>Ex marking of the components according to the following table:</p> <table border="1"> <thead> <tr> <th colspan="2">Coil Type AC19</th> </tr> <tr> <th>Coils with cable outlet</th> <th>Coils with terminal box</th> </tr> </thead> <tbody> <tr> <td> <b>ATEX:</b>                      EPS 16 ATEX 1 072 X                      II 2 G Ex mb IIC T4 Gb                      II 2 D Ex mb IIIC T130 °C Db                 </td> <td> <b>ATEX:</b>                      EPS 16 ATEX 1 072 X                      II 2 G Ex eb mb IIC T4 Gb                      II 2 D Ex mb tb IIIC T130 °C Db                 </td> </tr> </tbody> </table>	Coil Type AC19		Coils with cable outlet	Coils with terminal box	<b>ATEX:</b> EPS 16 ATEX 1 072 X II 2 G Ex mb IIC T4 Gb II 2 D Ex mb IIIC T130 °C Db	<b>ATEX:</b> EPS 16 ATEX 1 072 X II 2 G Ex eb mb IIC T4 Gb II 2 D Ex mb tb IIIC T130 °C Db
	Coil Type AC19						
Coils with cable outlet	Coils with terminal box						
<b>ATEX:</b> EPS 16 ATEX 1 072 X II 2 G Ex mb IIC T4 Gb II 2 D Ex mb IIIC T130 °C Db	<b>ATEX:</b> EPS 16 ATEX 1 072 X II 2 G Ex eb mb IIC T4 Gb II 2 D Ex mb tb IIIC T130 °C Db						
<p><b>Optional: Explosion protection according to category 3 (zone 2/22)</b></p> <p>Ex marking of the components according to the following table:</p> <table border="1"> <thead> <tr> <th colspan="2">Coil with plug contacts form A and cable plug Type 2509</th> </tr> <tr> <th>Coil Type AC10</th> <th>Coil Type AC19</th> </tr> </thead> <tbody> <tr> <td> <b>ATEX:</b>                      EPS 21 ATEX 1234 X                      II 3G Ex ec IIC T4 Gc                      II 3D Ex tc IIIC T135 °C Dc   <b>IECEx:</b>                      IECEx EPS 21.0078 X                      Ex ec IIC T4 Gc                      Ex tc IIIC T135 °C Dc                 </td> <td> <b>ATEX:</b>                      EPS 22 ATEX 1136 X                      II 3G Ex ec IIC T3 Gc                      II 3D Ex tc IIIC T200 °C Dc   <b>IECEx:</b>                      IECEx EPS 22.0018 X                      Ex ec IIC T3 Gc                      Ex tc IIIC T200 °C Dc                 </td> </tr> </tbody> </table>	Coil with plug contacts form A and cable plug Type 2509		Coil Type AC10	Coil Type AC19	<b>ATEX:</b> EPS 21 ATEX 1234 X II 3G Ex ec IIC T4 Gc II 3D Ex tc IIIC T135 °C Dc  <b>IECEx:</b> IECEx EPS 21.0078 X Ex ec IIC T4 Gc Ex tc IIIC T135 °C Dc	<b>ATEX:</b> EPS 22 ATEX 1136 X II 3G Ex ec IIC T3 Gc II 3D Ex tc IIIC T200 °C Dc  <b>IECEx:</b> IECEx EPS 22.0018 X Ex ec IIC T3 Gc Ex tc IIIC T200 °C Dc	
Coil with plug contacts form A and cable plug Type 2509							
Coil Type AC10	Coil Type AC19						
<b>ATEX:</b> EPS 21 ATEX 1234 X II 3G Ex ec IIC T4 Gc II 3D Ex tc IIIC T135 °C Dc  <b>IECEx:</b> IECEx EPS 21.0078 X Ex ec IIC T4 Gc Ex tc IIIC T135 °C Dc	<b>ATEX:</b> EPS 22 ATEX 1136 X II 3G Ex ec IIC T3 Gc II 3D Ex tc IIIC T200 °C Dc  <b>IECEx:</b> IECEx EPS 22.0018 X Ex ec IIC T3 Gc Ex tc IIIC T200 °C Dc						

3.5. North America (USA/Canada)

Approval	Description
	<p><b>Optional (valid for AC19 KD coils): UL Hazardous Locations – Explosion Protection</b></p> <p>UL Listed for Hazardous Locations for USA and Canada</p> <p>Class I, Zone 1                      Class I, Division 2, Group A, B, C and D                      Class II + III, Division 2, Group F and G</p>
	<p><b>Valid for coils: UL Recognized for the USA and Canada</b></p> <p>The coils are UL Recognized for the USA and Canada according to:</p> <ul style="list-style-type: none"> <li>• UL 429 (electrically operated valves)</li> <li>• CAN/CSA-C22.2 No. 139</li> </ul>

DTS 1000579974 EN Version: E Status: RL (released | freigegeben | valide) printed: 28.03.2024

## 4. Materials

### 4.1. Bürkert resistApp

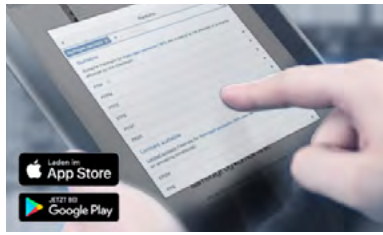

#### Bürkert resistApp – Chemical resistance chart

You want to ensure the reliability and durability of the materials in your individual application case? Verify your combination of media and materials on our website or in our resistApp.

[Start chemical resistance check](#)

### 4.2. Material specifications

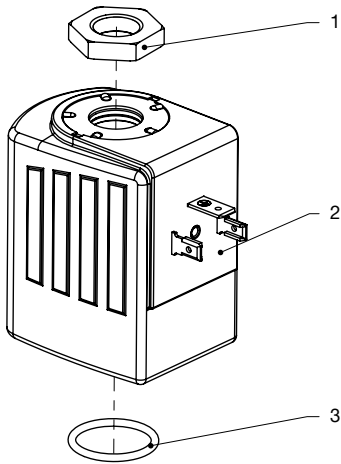

No.	Element	Material
1	Nut	DIN 176 thick film passivated or stainless steel
2	Coil	Epoxy
3	Seal	FKM

## 5. Dimensions

### 5.1. Standard version AC10

**Note:**

Dimensions in mm [inch]

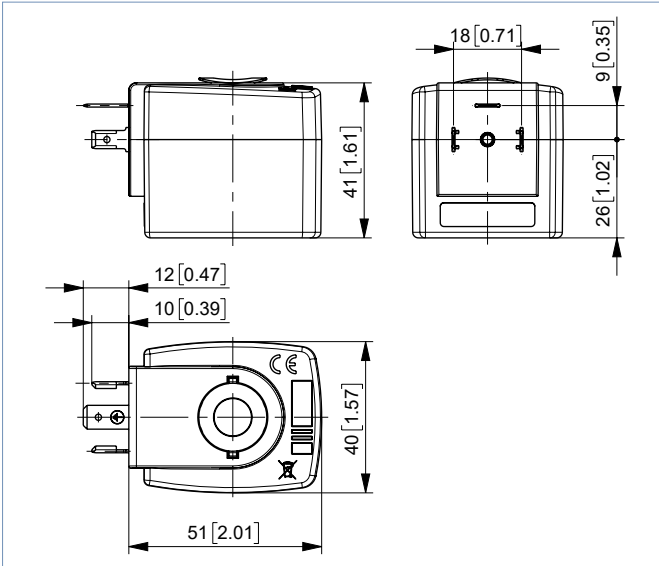

### 5.2. Standard version AC19

**Note:**

Dimensions in mm [inch]

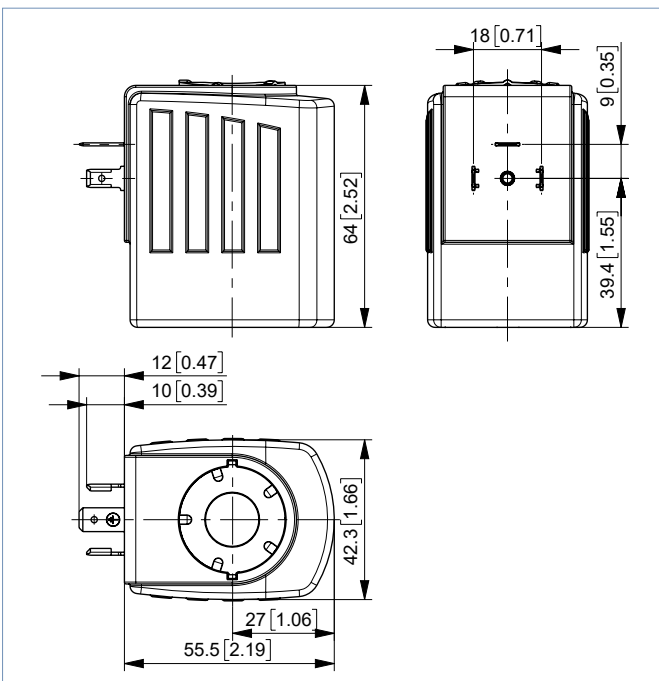

## 6. Performance specifications

### 6.1. Temperature diagram

#### Maximum ambient temperature

Maximum ambient temperature as a function of the power level and switching operations/min at maximum duty cycle.

#### Type AC10

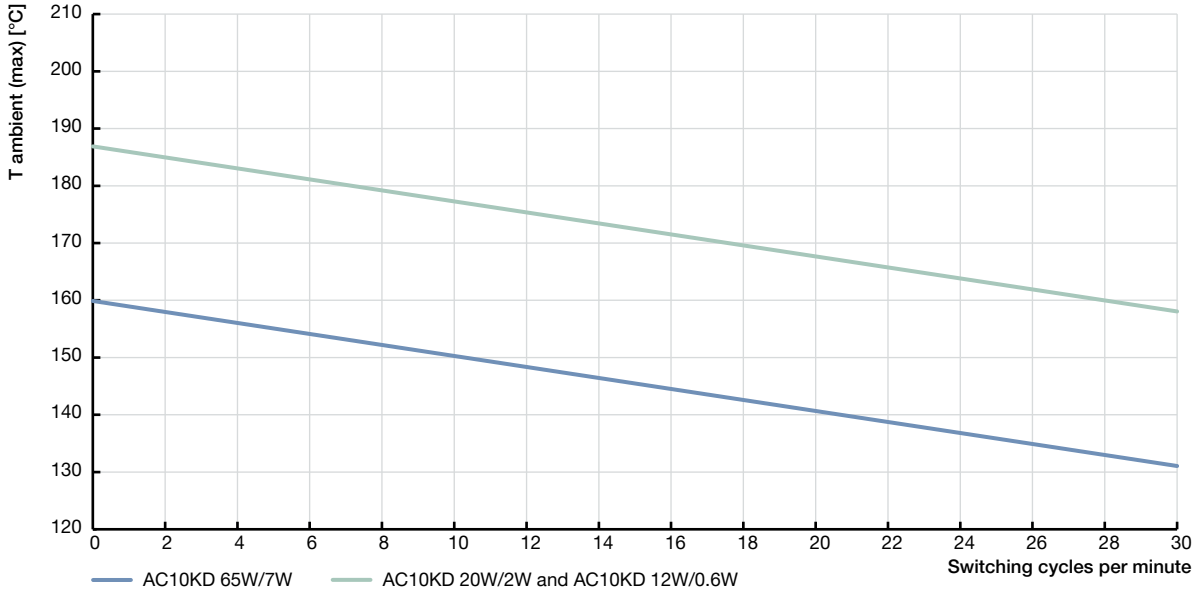

#### Maximum surface temperature

Maximum surface temperature depending on the power level and ambient temperature at 100 % duty cycle.

#### Type AC10

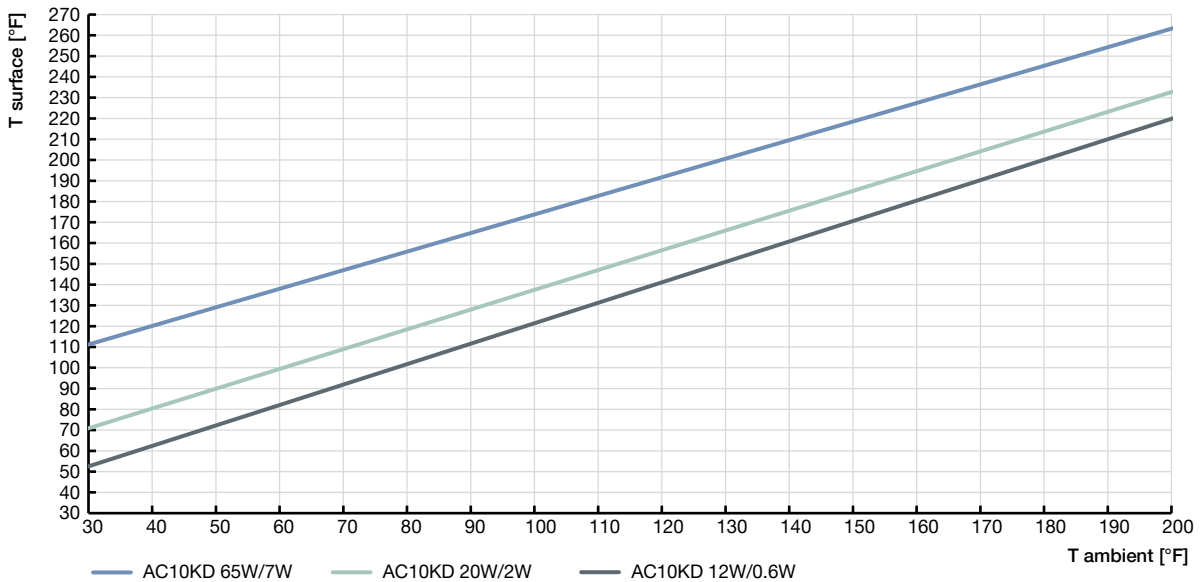



## 7. Ordering information

### 7.1. Bürkert eShop



**Bürkert eShop – Easy ordering and quick delivery**

You want to find your desired Bürkert product or spare part quickly and order directly? Our online shop is available for you 24/7. Sign up and enjoy all the benefits.

[Order online now](#)

### 7.2. Bürkert product filter

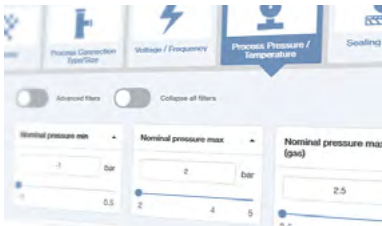

**Bürkert product filter – Get quickly to the right product**

You want to select products comfortably based on your technical requirements? Use the Bürkert product filter and find suitable articles for your application quickly and easily.

[Try out our product filter](#)

### 7.3. Ordering chart for Kick and Drop UL recognized (cURus) coil sets

**Note:**

- As replacement demand or for retrofitting
- Set contains Kick and Drop coil, seal and fixing nut.
- Further variants with alternative voltages are available on request.

Coil type	Recommended solenoid valves <sup>1.)</sup>	Electrical connection	Coil power		Article no.	
			Inrush power [W]	Holding power [W]	24 / AC/DC [V/Hz]	120/AC [V/Hz]
AC10 40 mm	6013, 6014, 6281, 5404, 6240 DN 6	DIN EN 175 301 - 803, form A	12	0.6	20044994 ☒	–
		DIN EN 175 301 - 803, form A	20	2	20045040 ☒	20045046 ☒
		DIN EN 175 301 - 803, form A	65	7	20045051 ☒	20045053 ☒
AC19 42 mm	6026, 6027, 6407, 6240 DN 12	DIN EN 175 301 - 803, form A	44	6.5	350043 ☒	o. r.
		Cable UL Listed for hazardous locations, Class I, Division 2	44	6.5	20024417 ☒	o. r.
		Terminal box UL Listed for hazardous locations, Class I, Division 2	44	6.5	o. r.	o. r.
		DIN EN 175 301 - 803, form A	85	8.5	338843 ☒	344831 ☒

– = not available

o. r. = on request

1.) A guaranteed use depends on the respective version and can only be confirmed after consultation with your Bürkert contact person.

DTS 1000579974 EN Version: E Status: RL (released | freigegeben | validé) printed: 28.03.2024

### 7.4. Ordering chart for Type 6013 with Kick and Drop UL recognized (cURus) coil

The Type 6013 valve is a direct-acting 2/2-way plunger valve. The Kick and Drop coil enables the holding power to be reduced by up to 10 watts, depending on the version, and an increase in the pressure range for the normally closed version.



**Note:**

- Further information on the solenoid valve, see data sheet **Type 6013** ▶.
- Further variants with stainless steel body without short circuit ring, alternative voltages, G or RC internal threads, as flange version or other seal materials are available on request.

Circuit function	Port connection	Orifice [mm]	C <sub>v</sub> value water [gal/min]	Coil power		Pressure range (MAWP <sup>1.)</sup> [psi]	Article no.	
				Inrush power [W]	Holding power [W]		24 / AC/DC [V/Hz]	120/AC [V/Hz]
<b>Brass body, NPT internal thread, seal material FKM/FKM</b>								
<b>CF A</b> 2/2-way solenoid valve Direct-acting Normally closed 	NPT 1/8	1.0	0.05	12	0.6	0...870	20046587	o. r.
	NPT 1/4	2.0	0.14	12	0.6	0...290	20046588	o. r.
		3.0	0.27			0...87	20046589	o. r.
		4.0	0.35			0...29	20046591	o. r.
		6.0	0.64			0...7.3	20046592	o. r.
	NPT 1/8	1.0	0.05	20	2	0...870	20046593	20046599
	NPT 1/4	2.0	0.14	20	2	0...435	20046594	20046600
		3.0	0.27			0...145	20046595	20046601
		4.0	0.35			0...58	20046596	20046602
		6.0	0.64			0...15	20046597	20046603
<b>CF B</b> 2/2-way solenoid valve Direct-acting Normally open 	NPT 1/8	1.0	0.05	20	2	0...580	20046618	20046625
	NPT 1/4	2.0	0.14	20	2	0...232	20046619	20046626
		3.0	0.27			0...116	20046622	20046627
		4.0	0.35			0...58	20046623	20046628
		6.0	0.64			0...29	20046624	20046629

o. r. = on request  
 1.) Maximum allowable working pressure

DTS 1000579974 EN Version: E Status: RL (released | freigegeben | validé) printed: 28.03.2024

**7.5. Ordering chart for Type 6014 with Kick and Drop UL recognized (cURus) coil**

The Type 6014 valve is a direct-acting 3/2-way plunger valve. The Kick and Drop coil enables the holding power to be reduced to up to 10 watts, depending on the version.



**Note:**

- Further information on the solenoid valve, see data sheet **Type 6014** ▶.
- Further variants with stainless steel body without short circuit ring, alternative voltages, G or RC internal threads, as flange version or other seal materials are available on request.

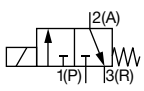
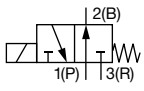
Circuit function	Port connection	Orifice [mm]	C <sub>v</sub> value water [gal/min]	Coil power		Pressure range (MAWP <sup>1.)</sup> [psi]	Article no.	
				Inrush power [W]	Holding power [W]		24/AC/DC [V/Hz]	120/AC [V/Hz]
<b>Brass body, NPT internal thread, seal material FKM/FKM</b>								
<b>CF C</b> 3/2-way solenoid valve Direct-acting Normally closed 	NPT 1/8	1.5	0.08	20	2	0...232	20046643	20046652
	NPT 1/4	2.0	0.13	20	2	0...145	20046644	20046653
		2.5	0.18			0...87	20046646	20046654
		3.0	0.23			0...58	20046647	20046655
<b>CF D</b> 3/2-way solenoid valve Direct-acting Normally open 	NPT 1/8	1.5	0.08	20	2	0...232	20046648	20046657
	NPT 1/4	2.0	0.13	20	2	0...145	20046649	20046658
		2.5	0.18			0...87	20046650	20046659
		3.0	0.23			0...58	20046651	20046660

1.) Maximum allowable working pressure

**7.6. Ordering chart for Type 6026 with Kick and Drop UL recognized (cURus) coil**

The Type 6026 valve is a direct-acting, media-separated 2/2-way plunger valve.



**Note:**

- Further information on the solenoid valve, see data sheet **Type 6026** ▶.
- Further variants with brass body without short circuit ring, alternative voltages, G or RC internal threads, as flange version or other seal materials are available on request.

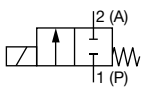
Circuit function	Port connection	Orifice	C <sub>v</sub> value water	Coil power		Pressure range (MAWP <sup>1.)</sup>	Article no.	
		[mm]	[gal/min]	Inrush power [W]	Holding power [W]		24/AC/DC [V/Hz]	120/AC [V/Hz]
<b>Stainless steel body, NPT internal thread, seal material PTFE</b>								
<b>CF A</b> 2/2-way solenoid valve Direct-acting Normally closed 	NPT ¼	4.0	0.6	44	6.5	0...145	20047002	20047005
		6.0	0.9				20047003	20047007

1.) Maximum allowable working pressure

DTS 1000579974 EN Version: E Status: RL (released | freigegeben | validé) printed: 28.03.2024

**7.7. Ordering chart for Type 6027 with Kick and Drop UL recognized (cURus) coil**

The Type 6027 valve is a direct-acting 2/2-way plunger valve. The Kick and Drop coil enables the holding power to be reduced by up to 14 watts, and an increase in the pressure range for the normally closed version.



**Note:**

- Further information on the solenoid valve, see data sheet **Type 6027** ▶.
- Further variants with stainless steel body, alternative voltages, G or RC internal threads, as flange or screw-in version or other seal materials are available on request.

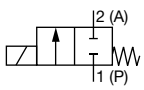
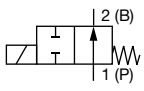
Circuit function	Port connection	Orifice [mm]	C <sub>v</sub> value water [gal/min]	Coil power		Pressure range (MAWP <sup>1.)</sup> [psi]	Article no.	
				Inrush power [W]	Holding power [W]		24/AC/DC [V/Hz]	120/AC [V/Hz]
<b>Brass body, NPT internal thread, seal material FKM/FKM (for orifice 12.0 mm only stainless steel body possible)</b>								
<b>CF A</b> 2/2-way solenoid valve Direct-acting Normally closed 	NPT ¼	3.0	0.32	44	6.5	0...435	20047372	20047385
		4.0	0.62			0...435	20047374	20047386
	NPT ½	6.0	1.1	44	6.5	0...87	20047375	20047387
		8.0	1.8			0...44	20047376	20047388
		10.0	2.1			0...29	20047377	20047389
	12.0	2.3			0...17	20010536	20047390	
<b>CF B</b> 2/2-way solenoid valve Direct-acting Normally open 	NPT ¼	3.0	0.32	44	6.5	0...232	20047379	20047391
		4.0	0.62			0...145	20047380	20047392
	NPT ½	6.0	1.1	44	6.5	0...87	20047381	20047393
		8.0	1.8			0...44	20047382	20047394
		10.0	2.1			0...29	20047383	20047395
	12.0	2.3			0...14.5	20047384	20047396	

1.) Maximum allowable working pressure

**7.8. Ordering chart for Type 6213 with Kick and Drop UL recognized (cURus) coil**

The Type 6213 valve is a servo-assisted 2/2-way diaphragm valve with spring coupling of the pilot valve and diaphragm. The Kick and Drop coil enables the holding power to be reduced to up to 14 watts, depending on the version.



**Note:**

- Further information on the solenoid valve, see data sheet **Type 6213** ▶.
- Further variants with stainless steel body without short circuit ring, alternative voltages, G or RC internal threads, as flange version or other seal materials are available on request.

Circuit function	Port connection	Orifice [mm]	C <sub>v</sub> value water [gal/min]	Coil power		Pressure range (MAWP <sup>1.)</sup> [psi]	Article no.	
				Inrush power [W]	Holding power [W]		24/AC/DC [V/Hz]	120/AC [V/Hz]
<b>Brass body, NPT internal thread, seal material FKM/FKM</b>								
<b>CF A</b> 2/2-way solenoid valve Direct-acting Normally closed 	NPT 3/8	10.0	2.2	20	2	0...145	20047795	20047798
	NPT 1/2	13.0	4.2	20	2	0...145	20047796	20047799
				44 <sup>2.)</sup>	6.5 <sup>2.)</sup>		20047801	20047803
	NPT 3/4	20.0	9.6	20	2	0...145	20047797	20047800
				44 <sup>2.)</sup>	6.5 <sup>2.)</sup>		20047802	20047804
	NPT 1	25.0	13	85	8.5	0...145	333893	333894
	NPT 1 1/4						333908	333909
	NPT 1 1/2	40.0	35	85	8.5	0...145	333923	333924
NPT 2	333926						333927	

1.) Maximum allowable working pressure  
 2.) Recommended for gas and vacuum applications

**7.9. Ordering chart for Type 6281 with Kick and Drop UL recognized (cURus) coil**

The Type 6281 valve is a servo-assisted 2/2-way diaphragm valve. A minimum differential pressure is required in order to function. The Kick and Drop coil enables the holding power to be reduced to up to 7 watts, depending on the version.



**Note:**

- Further information on the solenoid valve, see data sheet **Type 6281** ▶.
- Further variants with stainless steel body without short circuit ring, alternative voltages, G or RC internal threads, as flange version or other seal materials are available on request.

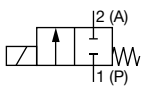
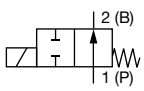
Circuit function	Port connection	Orifice [mm]	C <sub>v</sub> value water [gal/min]	Coil power		Pressure range (MAWP <sup>1.)</sup> [psi]	Article no.	
				Inrush power [W]	Holding power [W]		24/AC/DC [V/Hz]	120/AC [V/Hz]
<b>Brass body, NPT internal thread, seal material FKM/FKM</b>								
<b>CF A</b> 2/2-way solenoid valve Direct-acting Normally closed 	NPT ¼	10.0	1.7	12	0.6	3...232	20046915 ☞	–
				20	2		o. r.	20046943 ☞
	NPT ⅜	10.0	2.1	12	0.6	3...232	20046916 ☞	–
				20	2		o. r.	20046944 ☞
	NPT ½	13.0	4.4	12	0.6	3...232	20046917 ☞	–
				20	2		o. r.	20046945 ☞
	NPT ¾	20.0	9.8	12	0.6	3...232	20046918 ☞	–
				20	2		o. r.	20046946 ☞
	NPT 1	25.0	14	12	0.6	3...232	20046919 ☞	–
				20	2		o. r.	20046947 ☞
NPT 1¼	25.0	27	12	0.6	3...232	20046920 ☞	–	
			20	2		o. r.	20046948 ☞	
NPT 1½	40.0	35	12	0.6	3...232	20046921 ☞	–	
			20	2		o. r.	20046949 ☞	
NPT 2	50.0	46	12	0.6	3...232	20046922 ☞	–	
			20	2		o. r.	20046950 ☞	
NPT 2½	50.0	46	12	0.6	3...232	20046923 ☞	–	
			20	2		o. r.	20046951 ☞	
<b>CF B</b> 2/2-way solenoid valve Direct-acting Normally open 	NPT ¼	10.0	1.7	20	2	3...232	20046934 ☞	20046952 ☞
	NPT ⅜	10.0	2.1	20	2	3...232	20046935 ☞	20046953 ☞
	NPT ½	13.0	4.4	20	2	3...232	20046936 ☞	20046954 ☞
	NPT ¾	20.0	9.8	20	2	3...232	20046937 ☞	20046955 ☞
	NPT 1	25.0	14	20	2	3...232	20046938 ☞	20046956 ☞
	NPT 1¼	40.0	27	20	2	3...232	20046939 ☞	20046957 ☞
	NPT 1½	40.0	35	20	2	3...232	20046940 ☞	20046958 ☞
	NPT 2	50.0	46	20	2	3...232	20046941 ☞	20046959 ☞
NPT 2½	50.0	46	20	2	3...232	20046942 ☞	20046960 ☞	

o. r. = on request  
 – = not available  
 1.) Maximum allowable working pressure

DTS 1000579974 EN Version: E Status: RL (released | freigegeben | validé) printed: 28.03.2024

**7.10. Ordering chart for Type 5404 with Kick and Drop UL recognized (cURus) coil**

The Type 5404 valve is a servo-assisted 2/2-way piston valve. A minimum differential pressure is required in order to function. The Kick and Drop coil enables the holding power to be reduced to up to 9 watts, depending on the version.



**Note:**

- Further information on the solenoid valve, see data sheet **Type 5404** ▶.
- Further variants without short circuit ring, alternative voltages, G or RC internal threads, as flange version or other seal materials are available on request.

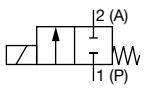
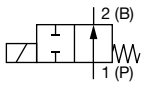
Circuit function	Port connection	Orifice [mm]	C <sub>v</sub> value water [gal/min]	Coil power		Pressure range (MAWP <sup>1.)</sup> [psi]	Article no.	
				Inrush power [W]	Holding power [W]		24/AC/DC [V/Hz]	120/AC [V/Hz]
<b>Brass body, NPT internal thread, seal material PTFE/FKM</b>								
<b>CF A</b> 2/2-way solenoid valve Direct-acting Normally closed 	NPT 1/2	12.0	2.3	12	0.6	15...725	20047561	–
				20	2		o. r.	20047568
	NPT 3/4	20.0	8	12	0.6	15...363	20047563	–
				20	2		o. r.	20047569
	NPT 1	25.0	11.5	12	0.6	15...363	20047564	–
				20	2		o. r.	20047570
<b>CF B</b> 2/2-way solenoid valve Direct-acting Normally open 	NPT 1/2	12.0	2.3	20	2	15...464	20047565	20047571
	NPT 3/4	20.0	8	20	2	15...363	20047566	20047572
	NPT 1	25.0	11.6	20	2	15...363	20047567	20047573

o. r. = on request  
 – = not available  
 1.) Maximum allowable working pressure

DTS 1000579974 EN Version: E Status: RL (released | freigegeben | validé) printed: 28.03.2024



### 7.11. Ordering chart for Type 6240 with Kick and Drop UL recognized (cURus) coil

The Type 6240 valve is a servo-assisted 2/2-way piston valve with spring coupling of the pilot valve and piston. The Kick and Drop coil enables the holding power to be reduced by up to 14 watts, and an increase in the pressure range, depending on the version.



**Note:**

- Further information on the solenoid valve, see data sheet **Type 6240** ▶.
- Further variants with brass body, alternative voltage, G or RC internal threads, as flange or cartridge version or other seal materials are available on request.

Circuit function	Port connection	Orifice [mm]	C <sub>v</sub> value water [gal/min]	Coil power		Pressure range (MAWP <sup>1.)</sup> [psi]	Article no.	
				Inrush power [W]	Holding power [W]		24/AC/DC [V/Hz]	120/AC [V/Hz]
<b>Stainless steel body, G-internal thread, seal material FKM/FKM</b>								
<b>CF A</b> 2/2-way solenoid valve Direct-acting Normally closed	NPT ¼	6.0	0.7	20	2	0...363	20047424	20047426
	NPT ⅜	6.0	0.7	20	2	0...363	20047425	20047427
	NPT ½	12.0	2.5	44	6.5	0...363	20047428	20047429

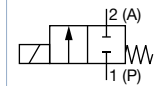

1.) Maximum allowable working pressure

### 7.12. Ordering chart for Type 6407 with Kick and Drop UL recognized (cURus) coil

The Type 6407 valve is a servo-assisted 2/2-way piston valve with fixed coupling of the pilot valve and piston.  
The Kick and Drop coil enables the holding power to be reduced to up to 14 watts.



**Note:**

- Further information on the solenoid valve, see data sheet [Type 6407](#) ▶.
- Further variants without short circuit ring, alternative voltages, G or RC internal threads, as flange version or other seal materials are available on request.

Circuit function	Port connection	Orifice [mm]	C <sub>v</sub> value water [gal/min]	Coil power		Pressure range (MAWP <sup>1.)</sup> [psi]	Article no.	
				Inrush power [W]	Holding power [W]		24/AC/DC [V/Hz]	120/AC [V/Hz]
<b>Brass body, NPT internal thread, seal material FKM/FKM</b>								
<b>CF A</b> 2/2-way solenoid valve Direct-acting Normally closed	NPT ½	13	4.3	44	6.5	0...145	20047538	20047541
	NPT ¾	20	6.5	44	6.5	0...145	20047539	20047542
	NPT 1	25	11.6	44	6.5	0...145	20047540	20047543

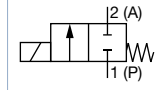

1.) Maximum allowable working pressure

DTS 1000579974 EN Version: E Status: RL (released | freigegeben | validé) printed: 28.03.2024

7.13. Ordering chart for accessories

Cable plug Type 2518, form A according to DIN EN 175301 - 803

Note:

- Dimensions in mm
- For further versions see data sheet [Type 2518](#) ▶.

Cable plug	Dimensions	Version	Voltage	Article no.
		Without circuitry (AC/DC)	0...250 V AC/DC	314802
		With LED (AC/DC)	12...24 V AC/DC	314812
		With LED and varistor (AC/DC)	12...24 V AC/DC	314820
		Without circuitry (AC/DC) with silicone seal for higher ambient temperature, e.g. steam version (NA07)	0...250 V AC/DC	361687

Cable plug Type 2509, form A according to DIN EN 175301 - 803

Note:

- Dimensions in mm
- Without circuitry (standard)
- The cable plug meets the requirements for UL hazloc Div. 2.
- The cable plug Type 2509 meets the requirements in accordance with UL Listed (UL 429) in assembly with a Bürkert solenoid valve.
- Refer to data sheet [Type 2509](#) ▶ for more information about the cable plug.

Cable plug	Dimensions	Version	Voltage	Article no.
		Without circuitry	0...250 V AC/DC	137943

DTS 1000579974 EN Version: E Status: RL (released | freigegeben | valide) printed: 28.03.2024