

Type 8792, 8793 REV.2

Electropneumatic positioner and process controller



We reserve the right to make technical changes without notice.

© Bürkert Werke GmbH & Co. KG, 2017-2023

Operating Instructions 2308/05_EN-en_00810648 / Original DE

CONTENTS

1	THE OPERATING INSTRUCTIONS	7
1.1	Symbols.....	7
1.2	Definition of terms.....	7
2	INTENDED USE	8
3	BASIC SAFETY INSTRUCTIONS	9
4	GENERAL INFORMATION.....	10
4.1	Contact addresses.....	10
4.2	Garantie légale	10
4.3	Warranty	10
4.4	Master code	10
4.5	Information on the Internet.....	10
5	PRODUCT DESCRIPTION.....	11
5.1	General description.....	11
5.2	Properties	11
5.3	Variants.....	14
6	STRUCTURE AND FUNCTION.....	15
6.1	Representation.....	15
6.2	Function diagram	16
7	POSITIONER TYPE 8792	17
7.1	Schematic representation of the position control	18
7.2	The positioner software	19
8	PROCESS CONTROLLER TYPE 8793.....	21
8.1	Schematic representation of process control	22
8.2	The process controller software.....	23
9	INTERFACES	25

10	TECHNICAL DATA	26
	10.1 Standards and directives.....	26
	10.2 Approvals	26
	10.3 Operating conditions	26
	10.4 Type label	27
	10.5 Mechanical data.....	27
	10.6 Electrical data	28
	10.7 Pneumatic data	29
	10.8 Safety end positions after failure of the electrical or pneumatic auxiliary power.....	30
11	ASSEMBLY	31
	11.1 Safety instructions	31
	11.2 Attachment to a continuous valve with linear actuator according to NAMUR.....	31
	11.3 Attachment to a continuous valve with rotary actuator	36
	11.4 Remote operation with external position sensor.....	39
	11.5 Pneumatic connection.....	42
12	ELECTRICAL INSTALLATION	44
	12.1 Electrical installation with circular plug-in connector (multipole variant).....	44
	12.2 Electrical installation with cable gland.....	49
13	OPERATION.....	53
	13.1 Description of the operating and display elements.....	53
	13.2 Function of the keys.....	55
	13.3 Adjusting the display	58
	13.4 Date and time	60
	13.5 Operating states.....	62
	13.6 Activating and deactivating auxiliary functions.....	62
	13.7 Manually opening and closing the valve.....	64
14	START-UP	65
	14.1 Safety instructions	65
	14.2 Basic setting of the device	66
	14.3 Activation of the process controller	69

15	BASIC SETTING OF THE PROCESS CONTROLLER.....	70
15.1	<i>P.CONTROL</i> – Setting up and parameterization of the process controller	70
15.2	<i>SETUP</i> – Setting up the process controller	71
15.3	<i>PID.PARAMETER</i> – Parameterizing the process controller	78
15.4	<i>P.Q’LIN</i> – Linearization of the process characteristic	82
15.5	<i>P.TUNE</i> – Self-optimization of the process controller	83
16	AUXILIARY FUNCTIONS	87
16.1	Activating and deactivating auxiliary functions.....	88
16.2	Manual configuration of <i>X.TUNE</i>	143
17	ACCESS TO THE BÜS SERVICE INTERFACE.....	147
17.1	Setting options for start-up via Bürkert Communicator.....	147
18	OPERATING STRUCTURE AND FACTORY SETTING	150
19	ETHERNET/IP, PROFINET AND MODBUS TCP	166
19.1	Technical data	166
19.2	Interfaces.....	167
19.3	Industrial Ethernet.....	167
19.4	Pin assignment.....	169
19.5	Bus status display.....	172
20	BÜS OPTION	174
20.1	Definition	174
20.2	Interfaces.....	174
20.3	Electrical installation - bÜS.....	174
20.4	Pin assignment.....	175
20.5	<i>BUS.COMM</i> – Settings on Type 8792, 8793	178
21	PROFIBUS DPV1	180
21.1	Technical data	180
21.2	Interfaces.....	181
21.3	Differences between the fieldbus devices and devices without a fieldbus	181

21.4	Electrical connections	182
21.5	Start-up PROFIBUS DPV1	186
21.6	Bus status display.....	188
22	MAINTENANCE AND TROUBLESHOOTING	189
22.1	Safety instruction	189
22.2	Maintenance.....	189
22.3	Error messages	189
22.4	Malfunctions.....	193
23	ACCESSORIES	194
23.1	Communication software.....	194
23.2	USB interface	194
24	PACKAGING, TRANSPORT.....	195
25	STORAGE	195
26	DISPOSAL	195
27	SUPPLEMENTARY INFORMATION	196
27.1	Selection criteria for continuous valves.....	196
27.2	Properties of PID controllers	198
27.3	Adjustment rules for PID controllers.....	203
28	TABLE FOR YOUR SETTINGS ON THE POSITIONER	207
28.1	Settings of the freely programmed characteristic.....	207
29	TABLE FOR YOUR SETTINGS ON THE TYPE 8793 PROCESS CONTROLLER	208
29.1	Set parameters of the process controller	208

1 THE OPERATING INSTRUCTIONS

The operating instructions describe the entire life cycle of the device. Keep these instructions in a location which is easily accessible to every user and make these instructions available to every new owner of the device.

Important safety information.

Read the operating instructions carefully and thoroughly. Study in particular the chapters entitled *Basic safety instructions* and *Intended use*.

- ▶ The operating instructions must be read and understood.

1.1 Symbols



DANGER

Warns of an immediate danger.

- ▶ Failure to observe the warning will result in fatal or serious injuries.



WARNING

Warns of a potentially dangerous situation.

- ▶ Failure to observe the warning may result in serious injuries or death.



CAUTION

Warns of a possible danger.

- ▶ Failure to observe this warning may result in a moderate or minor injury.

NOTE

Warns of damage to property.

- ▶ Failure to observe the warning may result in damage to the device or other equipment.



Indicates important additional information, tips and recommendations.



Refers to information in these operating instructions or in other documentation.

- ▶ Indicates instructions for risk prevention.

→ Indicates a procedure which you must carry out.

- ✔ Indicates a result.

1.2 Definition of terms

In these instructions, the term “device” always refers to the Type 8792, 8793 REV.2.

2 INTENDED USE

Use the device for its intended purpose only. Non-intended use of the device may be dangerous to people, nearby equipment and the environment.

The device is designed to be mounted on pneumatic actuators of process valves for the control of media.

- ▶ In potentially explosive atmospheres, Type 8792 and 8793 may be used only in accordance with the specification on the separate Ex type label. For the use, observe the ATEX manual with safety instructions for potentially explosive atmospheres.
- ▶ Devices without a separate Ex type label may not be used in potentially explosive atmospheres.
- ▶ Do not expose the device to direct sunlight.
- ▶ A pulsating direct voltage (rectified alternating voltage without smoothing) must not be used as the operating voltage.
- ▶ Use according to the authorized data, operating conditions, and conditions of use specified in the contract documents and operating instructions in chapter [“10 Technical data”](#) in these instructions and the valve instructions for the respective pneumatically actuated valve.
- ▶ Use the device only in conjunction with third-party devices and components recommended and authorized by Bürkert.
- ▶ In view of the wide range of possible application cases, check whether the device is suitable for the specific application case and check this out if required.
- ▶ Correct transportation, storage and installation as well as careful operation and maintenance are essential for reliable and fault-free operation.
- ▶ Use Types 8792 and 8793 only as intended.

3 BASIC SAFETY INSTRUCTIONS

These safety instructions do not consider any contingencies or incidents which occur during assembly, operation and maintenance.

The operator is responsible for observing the location-specific safety regulations, also with reference to the personnel.



Danger – high pressure.

- ▶ Before loosening lines and valves, turn off the pressure and vent the lines.

Risk of electric shock.

- ▶ Before reaching into the device or the equipment, switch off the power supply and secure to prevent reactivation.
- ▶ Observe applicable accident prevention and safety regulations for electrical equipment.

General hazardous situations.

To prevent injuries:

- ▶ Ensure that the system cannot be activated unintentionally.
- ▶ Installation and maintenance work may only be carried out by authorized specialist personnel and using the appropriate tools.
- ▶ After an interruption in the electrical or pneumatic supply, ensure that the process is restarted in a defined or controlled manner.
- ▶ The device may only be operated when in perfect condition and in consideration of the operating instructions.
- ▶ Do not supply the pressure supply connection of the system with aggressive or flammable media or any liquids.
- ▶ Do not physically stress the housing (e.g. by placing objects on it or standing on it).
- ▶ Do not make any external modifications to the device housings. Do not paint housing parts or screws.
- ▶ The general rules of technology must be observed for application planning and operation of the device.

NOTE

Electrostatic sensitive components / modules.

The device contains electronic components that are susceptible to electrostatic discharging (ESD). Components that come into contact with electrostatically charged people or objects are at risk. In the worst case scenario, these components are destroyed immediately or fail after start-up.

- ▶ Meet the requirements specified by EN 61340-5-1 to minimize or avoid the possibility of damage caused by sudden electrostatic discharge.
- ▶ Do not touch electronic components when the supply voltage is connected.



Failure to observe these operating instructions and the information contained therein as well as unauthorized tampering with the device release us from any liability and also invalidate the warranty covering the devices and accessories.

4 GENERAL INFORMATION

4.1 Contact addresses

Germany

Bürkert Fluid Control System
Chr.-Bürkert-Str. 13-17
D-74653 Ingelfingen
E-mail: info@burkert.com

International

Contact addresses can be found on the final pages of the printed brief instructions (Quickstart).

And also on the Internet at: www.burkert.com

4.2 Garantie légale

La condition pour bénéficier de la garantie légale est l'utilisation conforme de l'appareil dans le respect des conditions d'utilisation spécifiées.

4.3 Warranty

The warranty is only valid if the device is used as intended in accordance with the specified condition of use.

4.4 Master code

Operation of the device can be locked via a freely selectable user code. In addition, there is a non-changeable master code with which you can perform all operator actions on the device. This 4-digit master code can be found on the last pages of the printed brief instructions which are enclosed with each device.

If required, cut out the code and keep it separate from these operating instructions.

4.5 Information on the Internet

The operating instructions and data sheets for Types 8792 and 8793 can be found on the Internet at: www.burkert.com

5 PRODUCT DESCRIPTION

5.1 General description

The positioner Type 8792 / process controller Type 8793 is a digital, electro-pneumatic position controller for pneumatically actuated continuous valves. The device incorporates the main function groups

- Position sensor
- Electro-pneumatic actuating system
- Microprocessor electronics

The position sensor measures the current positions of the continuous valve.

The microprocessor electronics continuously compare the current position (actual value) with a position set-point value specified via the standard signal input and supplies the result to the positioner.

If there is a control difference, the electro-pneumatic actuating system corrects the actual position accordingly.

5.2 Properties

- **Variants**
 - Positioner (position controller) Type 8792
 - Process controller with integrated position controller, Type 8793.
- **Position sensor**
 - internal conductive plastic potentiometer with high resolution or
 - external non-contacting non-wearing position sensor (remote).
- **Microprocessor-controlled electronics**
for signal processing, control and valve control.
- **Control module**
The device is operated by 4 keys. The 128 x 64 dot matrix graphics display enables you to display the set-point value or actual value and to configure and parameterize via menu functions.
- **Actuating system**
The actuating system consists of 2 solenoid valves and 4 diaphragm boosters. In single-acting actuators the working connection 2 must be sealed with a threaded plug.
- **Feedback (optional)**
Feedback is either via 2 proximity switches (initiators), digital outputs or via an output (4 – 20 mA / 0 – 10 V). When the valve reaches an upper or lower position, this position can be relayed e.g. to a PLC via digital outputs. The operator can change the initiators or limit positions via control lugs.
- **Pneumatic interfaces**
Internal thread G1/4"
- **Electrical interfaces**
Circular plug-in connector or cable gland
- **Housing**
Plastic coated aluminum housing with hinged cover and captive screws.
- **Attachment**
to a linear actuator according to recommendation given by NAMUR (DIN IEC 534-6) or to a rotary actuator according to VDI/VDE 3845.
- **Optional**
Remote variant for DIN rail mounting or mounting bracket.

5.2.1 Combination with valve types and mounting variants

The positioner Type 8792 / process controller Type 8793 can be mounted on different continuous valves. For example on valves with piston, membrane or rotary actuator. The actuators can be single-acting or double-acting.

- For single-acting actuators, only one chamber is aerated and deaerated during actuation. The generated pressure works against a spring. The piston moves until there is an equilibrium of forces between compressive force and spring force. To do this, one of the two air connections must be sealed with a threaded plug.
- For double-acting actuators the chambers on both sides of the piston are pressurized. In this case, one chamber is aerated when the other one is deaerated and vice versa. In this variant, no spring is installed in the actuator.

Two basic device variants are available for positioner Type 8792 / process controller Type 8793. They differ as to the mounting options and the position sensor.

NAMUR device variant:

An internal position sensor is used which is designed as a rotary potentiometer. Type 8792/8793 is mounted directly on the actuator or attached to the side.

Remote device variant:

An external position sensor (linear or rotary) is connected via an interface. Type 8792/8793 is attached to a wall either with a standard rail or with a mounting bracket (remote variant).

5.2.2 Overview of the mounting options

<p>Attachment of NAMUR on rotary actuator</p>	
<p>Attachment of NAMUR with a mounting bracket on a linear actuator</p>	
<p>Remote mounting with mounting bracket</p>	
<p>Remote mounting with standard rail</p>	

Table 1: Overview of the mounting options

MAN 1000341264 EN Version: F Status: RL (released | freigegeben) printed: 01.09.2023

5.3 Variants

5.3.1 Type 8792, positioner

The position of the actuator is controlled according to the position set-point value. The position set-point value is specified by an external standard signal (or via fieldbus).

5.3.2 Type 8793, process controller

Type 8793 also features a PID controller which, apart from actual position control, can also be used to implement process control (e.g. level, pressure, flow rate, temperature) in the sense of a cascade control.

The process controller Type 8793 is operated with a 128 x 64 dot matrix graphics display and a keypad with 4 keys.

The process controller is linked to a control circuit. The set-point position of the valve is calculated from the process set-point value and the process actual value via the control parameters (PID controller). The process set-point value can be specified by an external signal.

5.3.3 Type 8793, remote variant



Depending on the connection variant type of the position sensor, Type 8793 functions as a

- Process controller or
- Positioner (position controller)

The following connection variants are available:

Function Type 8793	Interface	Position sensor	Setting in the menu (<i>ADD.FUNCTION</i>)
Process controller	digital (serial)	Remote sensor Type 8798	<i>POS.SENSOR</i> → <i>DIGITAL</i> For menu description see chapter “16.1.21 POS.SENSOR” on page 120
Positioner (position controller)	analog (4 – 20 mA) *	any high-resolution position sensor	<i>POS.SENSOR</i> → <i>ANALOG</i> For menu description see chapter “16.1.21 POS.SENSOR” on page 120

Table 2: Connection variants Type 8793 with external position sensor



* If the external position sensor is connected to the process controller Type 8793 via the analog interface, it can be operated only as a positioner (position controller).

The options for connection of an external position sensor are described in chapter [“11.4 Remote operation with external position sensor”](#) on page 39.

6 STRUCTURE AND FUNCTION

The positioner Type 8792 and process controller Type 8793 consist of the micro-processor controlled electronics, the position sensor and the actuating system.

The device is designed using three-wire technology. Operation is controlled by four keys and a 128x64 dot matrix graphics display.

The pneumatic actuating system for single-acting and double-acting actuators consists of 2 solenoid valves.

6.1 Representation

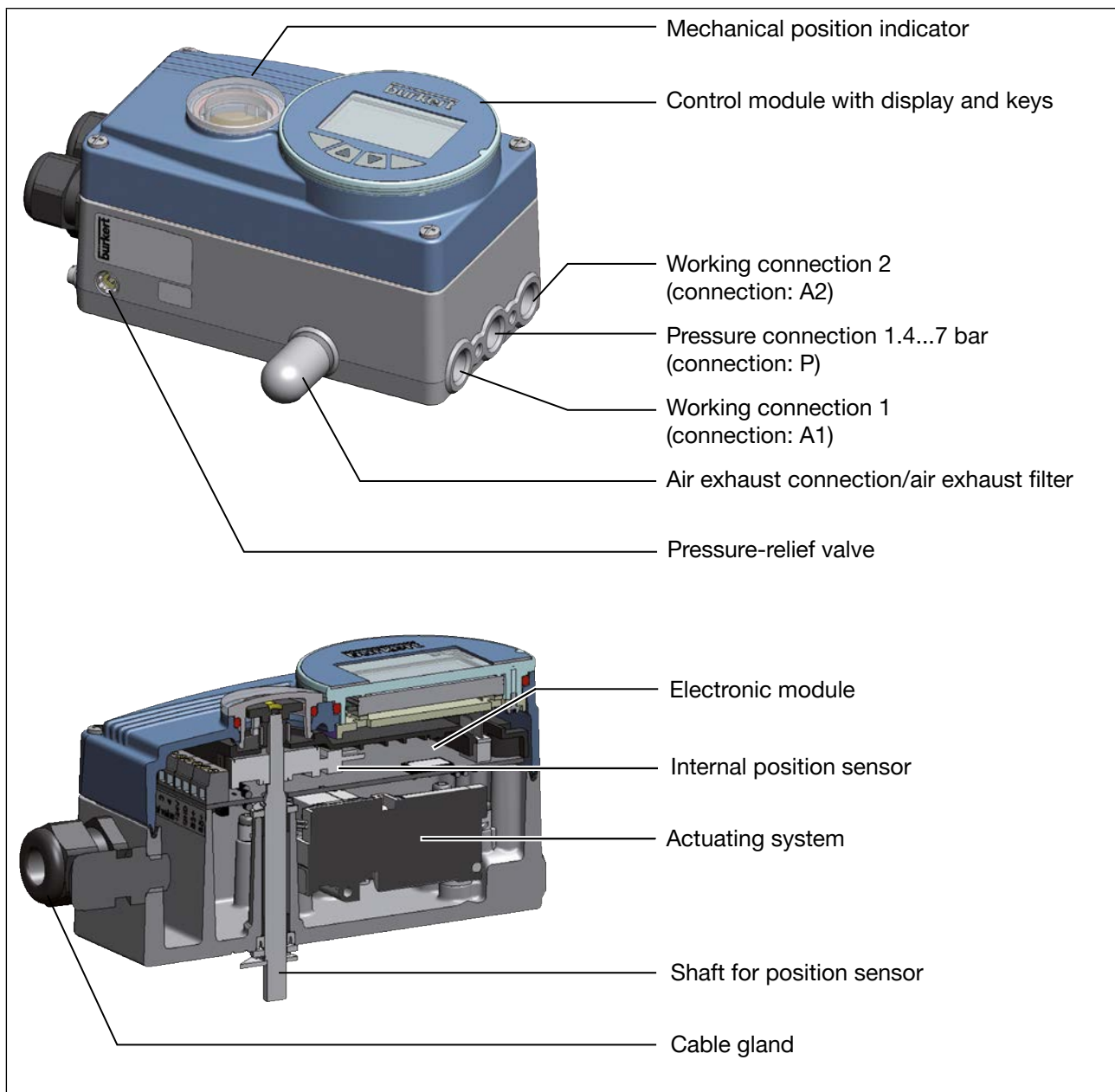

Figure 1: Structure, Type 8792/8793

6.2 Function diagram

6.2.1 Diagram illustrating single-acting actuator

The black lines in “Figure 2” describe the function of the position controller circuit in Type 8792.

The gray part of the diagram indicates the additional function of the superimposed process control circuit in Type 8793.

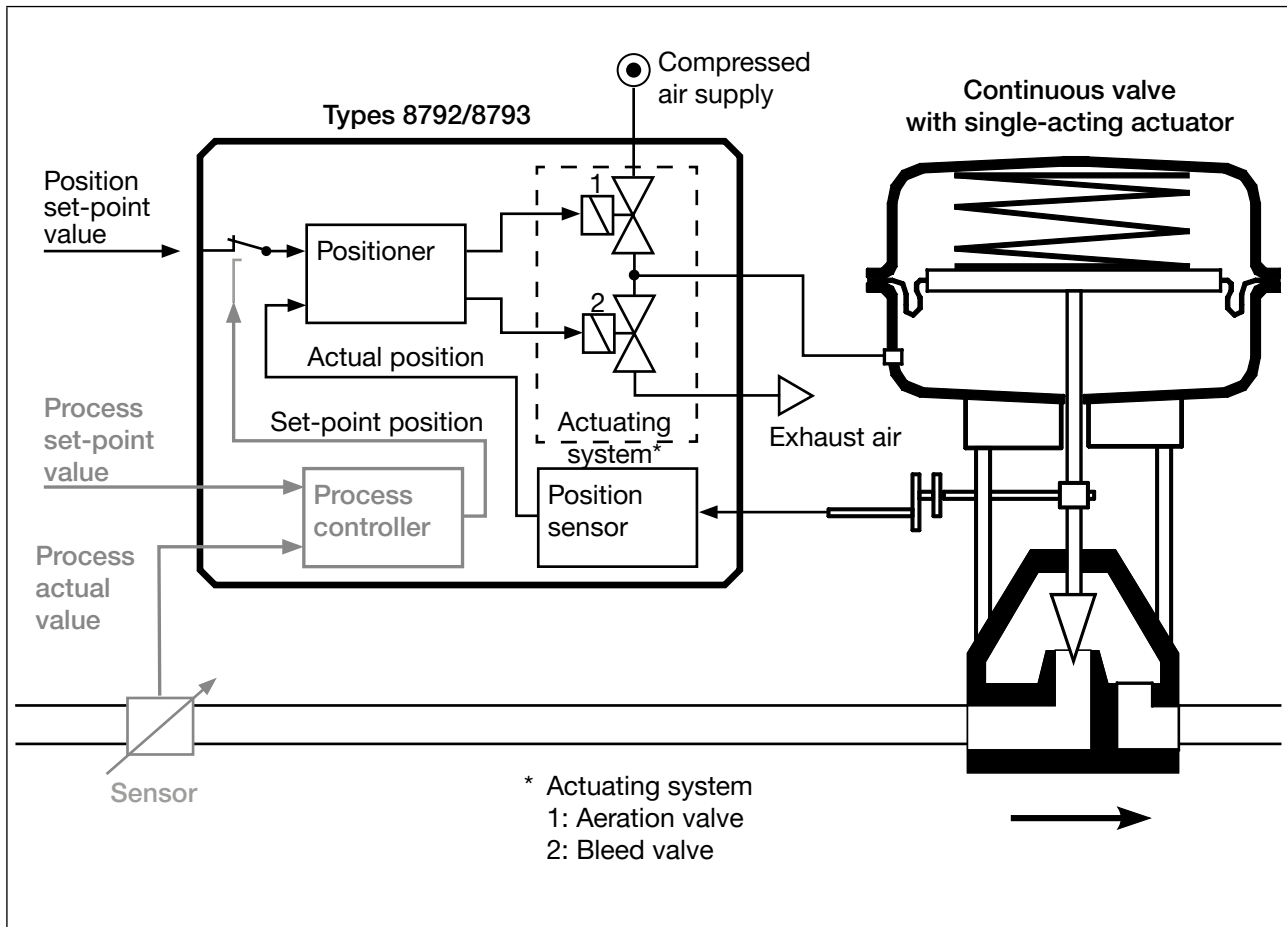

Figure 2: Structure, positioner Type 8792 / process controller Type 8793

! The remote variant has the position sensor situated outside the device directly on the continuous valve and is connected to the latter by a cable.

7 POSITIONER TYPE 8792

The position sensor records the current position (*POS*) of the pneumatic actuator. The positioner compares this position actual value with the set-point value (*CMD*) which is specified as a standard signal. If there is a control difference (*Xd1*), the actuator is aerated and de-aerated via the actuating system. In this way the position of the actuator is changed until control difference is 0. *Z1* represents a disturbance variable.

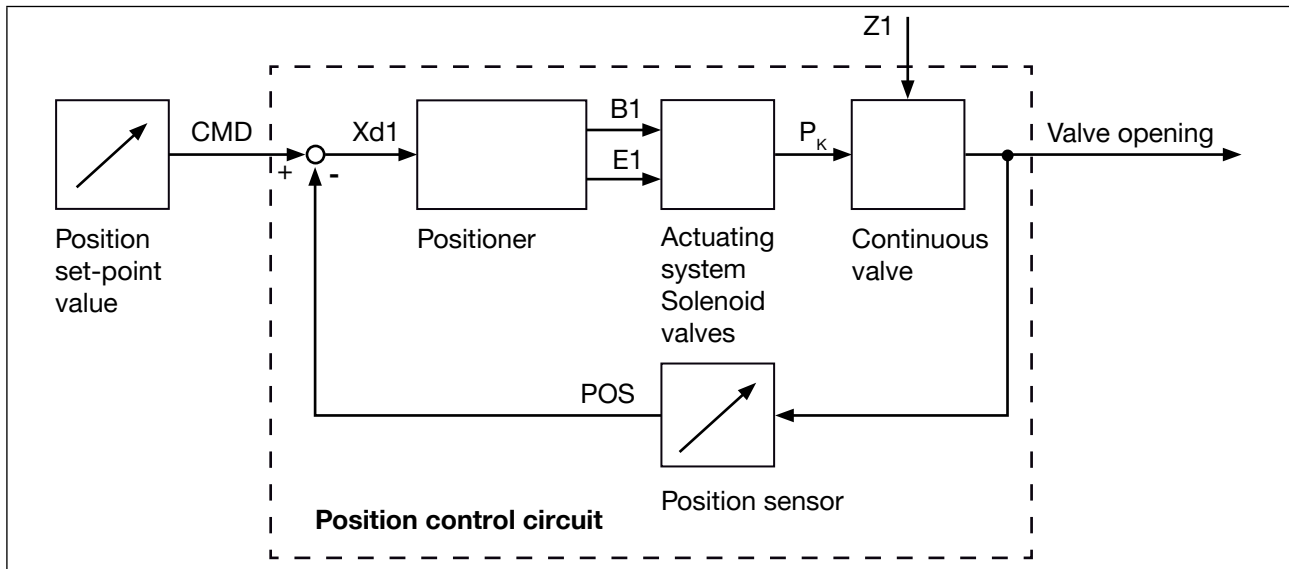

Figure 3: Position control circuit in Type 8792

7.1 Schematic representation of the position control

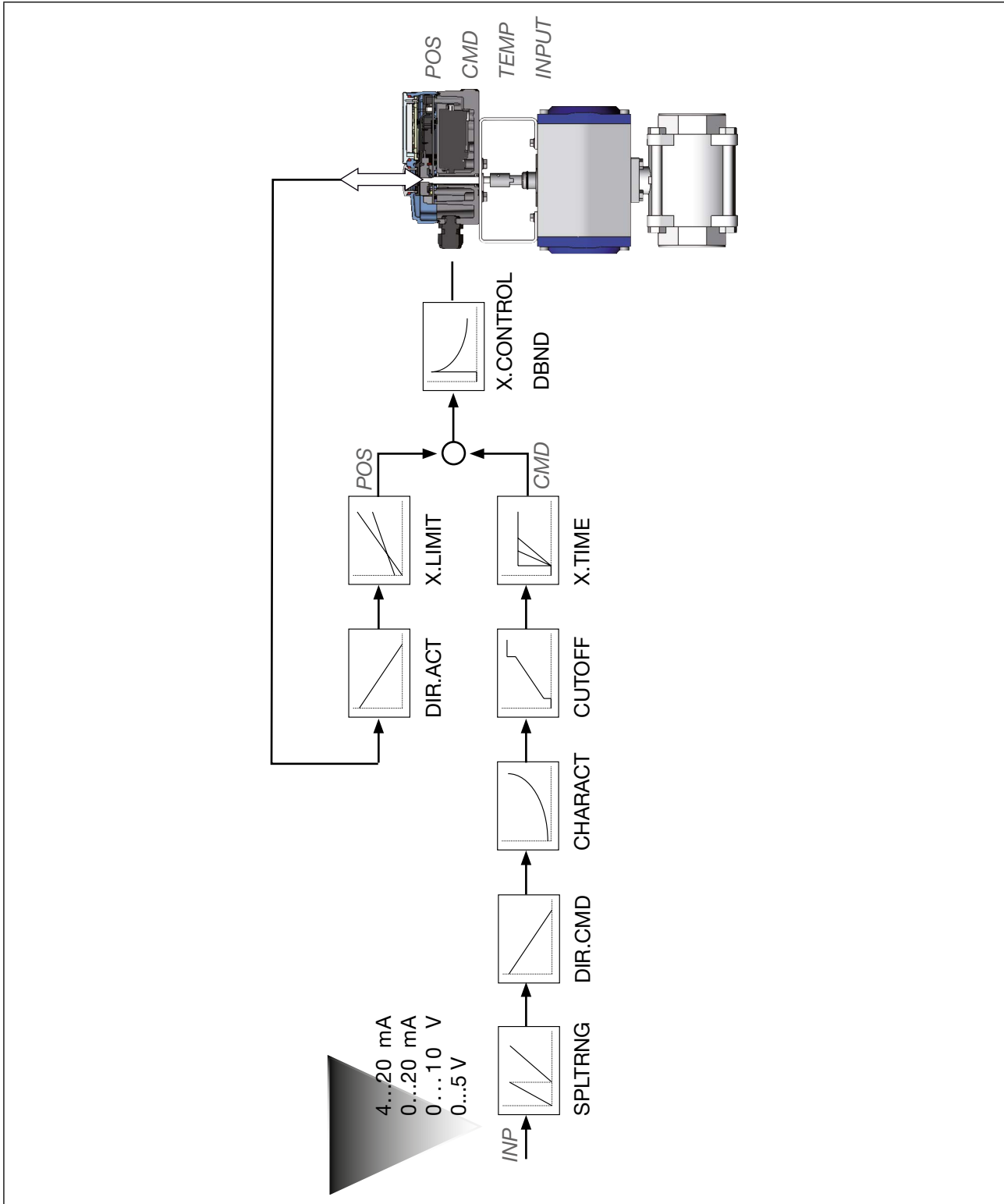

Figure 4: Schematic representation of position control

7.2 The positioner software

Configurable auxiliary functions	Effect
Correction line to adjust the operating characteristic <i>CHARACT</i>	Selection of the transfer characteristic between input signal and stroke (correction characteristic).
Sealing function <i>CUTOFF</i>	Valve closes tight outside the control range. Specification of the value (as%), from which the actuator is completely de-aerated (when 0%) or aerated (when 100 %).
Effective direction of the controller set-point value <i>DIR.CMD</i>	Effective direction between input signal and set-point position.
Effective direction of the actuating drive <i>DIR.ACT</i>	Adjustment of the effective direction between aeration state of the actuator and the actual position.
Signal split range <i>SPLTRNG</i>	Splitting of the standard signal range to two or more positioners.
Stroke limit <i>X.LIMIT</i>	Mechanical valve piston movement only within a defined stroke range.
Limit of the control speed <i>X.TIME</i>	Input of the opening and closing time for the total stroke.
Insensitivity range <i>X.CONTROL</i>	The positioner is initially actuated from a control difference to be defined.
Code protection <i>SECURITY</i>	Code protection for settings.
Safety position <i>SAFEPOS</i>	Definition of the safety position.
Signal level fault detection <i>SIG.ERROR</i>	Check the input signals for sensor break. Warning output on the display and approaching the safety position (if selected).
Digital input <i>BINARY. IN</i>	Switching between AUTOMATIC / MANU or approaching the safety position.
Analogue feedback (option) <i>OUTPUT</i>	Feedback set-point value or actual value.
2 digital outputs (option) <i>OUTPUT</i>	Output of two selectable digital values.
User calibration <i>CAL.USER</i>	Change to the factory calibration of the signal input.
Factory settings <i>SET.FACTORY</i>	Reset to factory settings.

Configurable auxiliary functions	Effect
Serial interface <i>SER.I/O</i>	Configuration of serial interface.
Setting display <i>EXTRAS</i>	Adjustment of the display of the process level.
<i>SERVICE</i>	For internal use only.
<i>POS.SENSOR</i>	Setting interface remote position sensor (available for Type 8793 Remote only). See chapter “5.3.3 Type 8793, remote variant” on page 14
Simulation software <i>SIMULATION</i>	For simulation of the device functions.
<i>DIAGNOSE (option)</i>	Monitoring of processes.

Table 3: Positioner software. Configurable auxiliary functions

Hierarchical operating concept for easy operation on the following operating levels	
Process level	On the process level you switch between the AUTOMATIC and MANU operating states.
Setting level	On the setting level specify certain basic functions during start-up and configure auxiliary functions if required.

Table 4: The positioner software. Hierarchical operating concept.

8 PROCESS CONTROLLER TYPE 8793

In the case of process controller Type 8793 the position control mentioned in chapter “7” becomes the subordinate auxiliary control circuit; this results in a cascade control. The process controller in the main control circuit of Type 8793 has a PID function. The process set-point value (*SP*) is specified as set-point value and compared with the actual value (*PV*) of the process variable to be controlled. The position sensor records the current position (*POS*) of the pneumatic actuator. The positioner compares this position actual value with the set-point value (*CMD*) which is specified by the process controller. If there is a control difference (*Xd1*), the actuator is aerated and de-aerated via the actuating system. In this way the position of the actuator is changed until control difference is 0. *Z2* represents a disturbance variable.

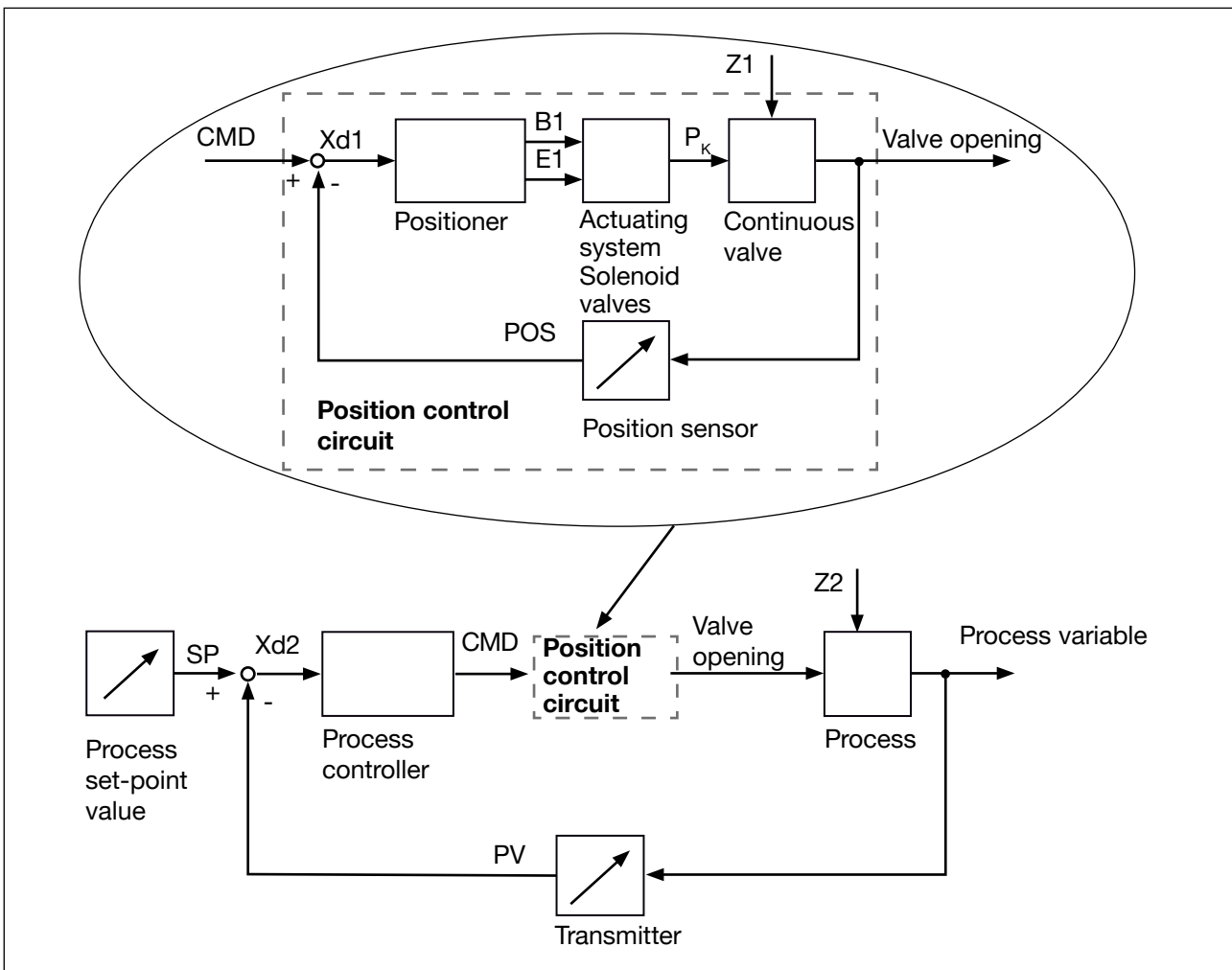

Figure 5: Signal flow plan of process controller

MAN 1000341264 EN Version: F Status: RL (released | freigegeben) printed: 01.09.2023

8.1 Schematic representation of process control

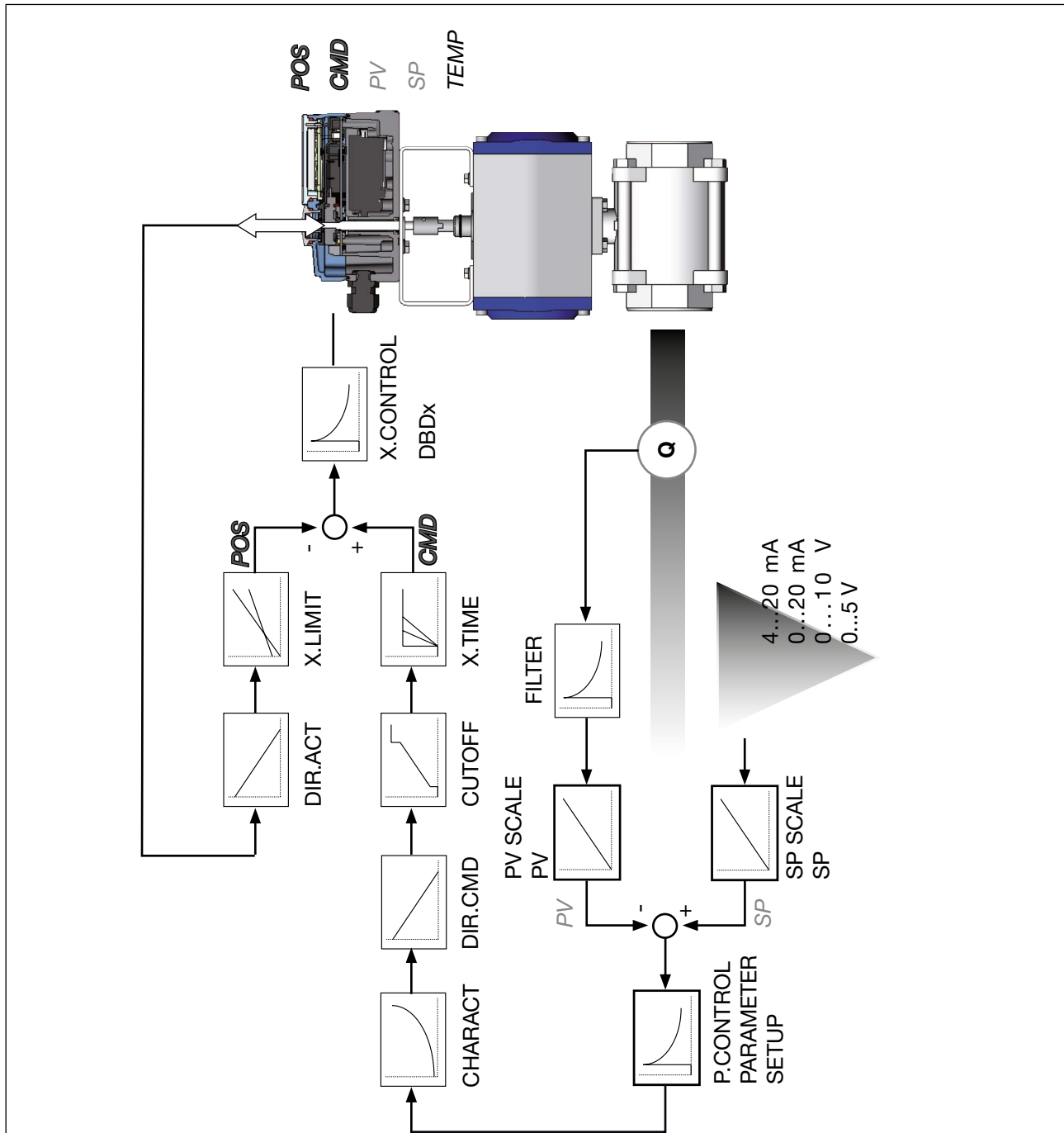

Figure 6: Schematic representation of process control

8.2 The process controller software

Configurable auxiliary functions	Effect
Correction line to adjust the operating characteristic <i>CHARACT</i>	Selection of the transfer characteristic between input signal and stroke (correction characteristic).
Sealing function <i>CUTOFF</i>	Valve closes tight outside the control range. Specification of the value (as%), from which the actuator is completely de-aerated (when 0%) or aerated (when 100 %).
Effective direction of the controller set-point value <i>DIR.CMD</i>	Effective direction between input signal and set-point position.
Effective direction of the actuating drive <i>DIR.ACT</i>	Adjustment of the effective direction between aeration state of the actuator and the actual position.
Signal split range <i>SPLTRNG</i>	Splitting of the standard signal range to two or more positioners.
Stroke limit <i>X.LIMIT</i>	Mechanical valve piston movement only within a defined stroke range.
Limit of the control speed <i>X.TIME</i>	Input of the opening and closing time for the entire stroke.
Insensitivity range <i>X.CONTROL</i>	The positioner is initially actuated from a control difference to be defined.
Code protection <i>SECURITY</i>	Code protection for settings.
Safety position <i>SAFEPOS</i>	Definition of the safety position.
Signal level fault detection <i>SIG.ERROR</i>	Check the input signals for sensor break. Warning output on the display and approaching the safety position (if selected).
Digital input <i>BINARY. IN</i>	Switching between AUTOMATIC / MANU or approaching the safety position.
Analogue feedback (option) <i>OUTPUT</i>	Feedback set-point value or actual value.
2 digital outputs (option) <i>OUTPUT</i>	Output of two selectable digital values.
User calibration <i>CAL.USER</i>	Change to the factory calibration of the signal input.
Factory settings <i>SET.FACTORY</i>	Reset to factory settings.
Serial interface <i>SER.I/O</i>	Configuration of serial interface.

Configurable auxiliary functions	Effect
Setting display <i>EXTRAS</i>	Adjustment of the display of the process level.
<i>SERVICE</i>	For internal use only.
<i>POS.SENSOR</i>	Setting interface remote position sensor (available for Type 8793 Remote only). See chapter “5.3.3 Type 8793, remote variant” on page 14
Simulation software <i>SIMULATION</i>	For simulation of the device functions.
<i>DIAGNOSE (option)</i>	Monitoring of processes.

Table 5: The process controller software. Configurable auxiliary functions of the position controller

Functions and setting options of the process controller	
Process controller <i>P.CONTROL</i>	PID process controller is activated.
Adjustable parameters <i>P.CONTROL - PARAMETER</i>	Parameterization of the process controller Proportional coefficient, reset time, hold-back time and operating point.
Scalable inputs <i>P.CONTROL - SETUP</i>	Configuration of the process controller - Selection of the sensor input - Scaling of process actual value and process set-point value - Selection of the set-point value defaults.
<i>Automatic sensor detection or manual sensor setting</i> <i>P.CONTROL - SETUP - PV INPUT</i>	Sensor types Pt 100 and 4 – 20 mA are automatically detected or can be manually set via the operating menu.
Selection of the set-point value default <i>P.CONTROL - SETUP - SP INPUT</i>	Set-point value default either via standard signal input or via keys.
<i>Process characteristic linearization</i> <i>P.Q'LIN</i>	Function for the automatic linearization of the process characteristics.
<i>Process controller optimization</i> <i>P.TUNE</i>	Function for automatic optimization of the process controller parameters.

Table 6: The process controller software. Functions and setting options of the process controller

Hierarchical operating concept for easy operation on the following operating levels	
Process level	On the process level you switch between the AUTOMATIC and MANU operating states.
Setting level	On the setting level specify certain basic functions during start-up and configure auxiliary functions if required.

Table 7: The process controller software. Hierarchical operating concept

9 INTERFACES

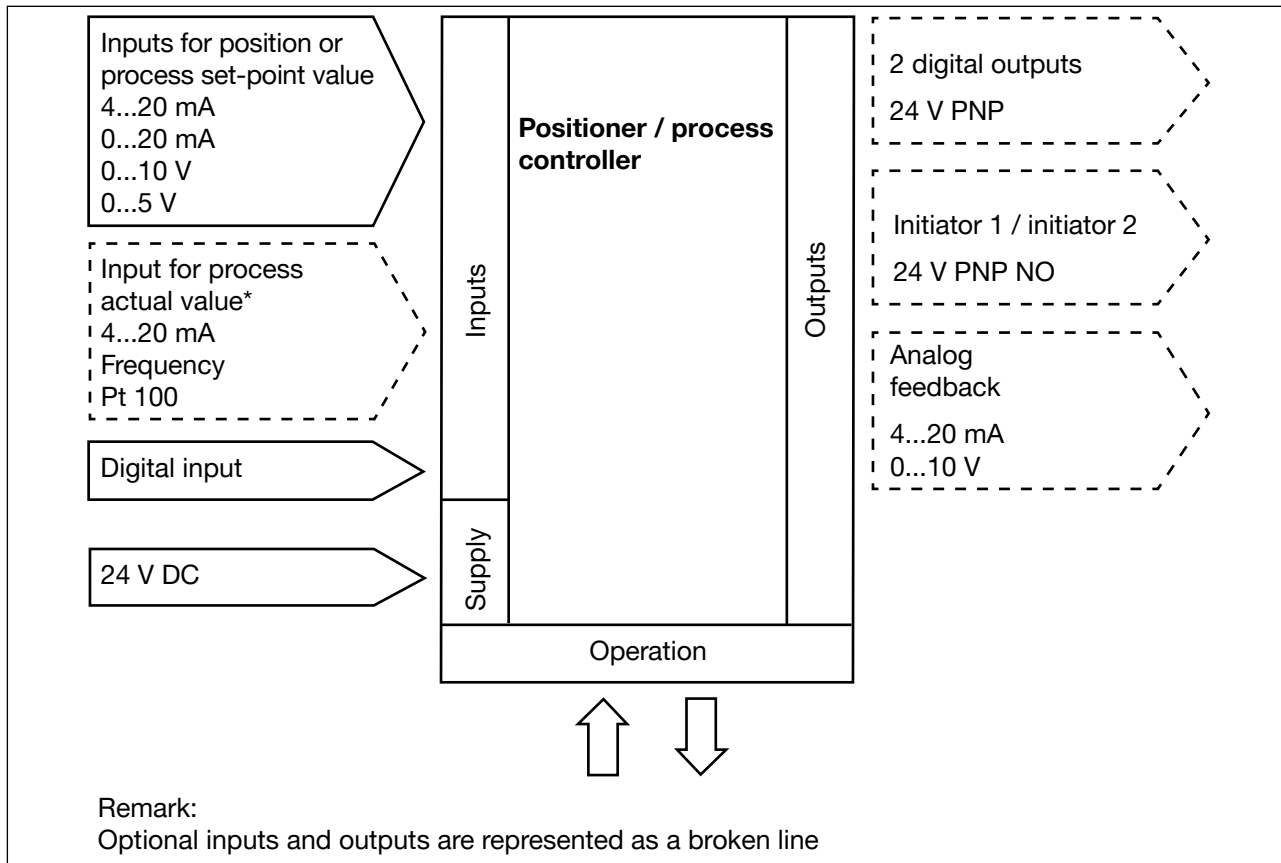

Figure 7: Interfaces of the positioner / process controller

! Types 8792 and 8793 are 3-wire devices, i.e. the power (24 V DC) is supplied separately from the set-point value signal.

* only for process controller Type 8793

10 TECHNICAL DATA

10.1 Standards and directives

The device complies with the relevant EU harmonisation legislation. In addition, the device also complies with the requirements of the laws of the United Kingdom.

The harmonised standards that have been applied for the conformity assessment procedure are listed in the current version of the EU Declaration of Conformity/UK Declaration of Conformity.

10.2 Approvals

The product is approved for use in zone 2 and 22 in accordance with ATEX directive 2014/34/EU category 3GD.



Observe instructions on operation in potentially explosive atmospheres. See supplementary ATEX instructions.

10.3 Operating conditions



WARNING

Solar radiation and temperature fluctuations may cause malfunctions or leaks.

- ▶ If the device is used outdoors, do not expose it unprotected to the weather conditions.
- ▶ The permitted ambient temperature may not exceed the maximum value or drop below the minimum value.

Ambient temperature -10 – +60 °C

Operating altitude up to 2000 m above sea level

Degree of protection IP65 / IP67* according to EN 60529
(only if cables and plugs and sockets connected correctly)

** If the positioner is used under IP67 conditions, the ventilation filter (see “Figure 1: Structure, Type 8792/8793”) must be removed and the exhaust air conveyed to the dry area.*

10.4 Type label

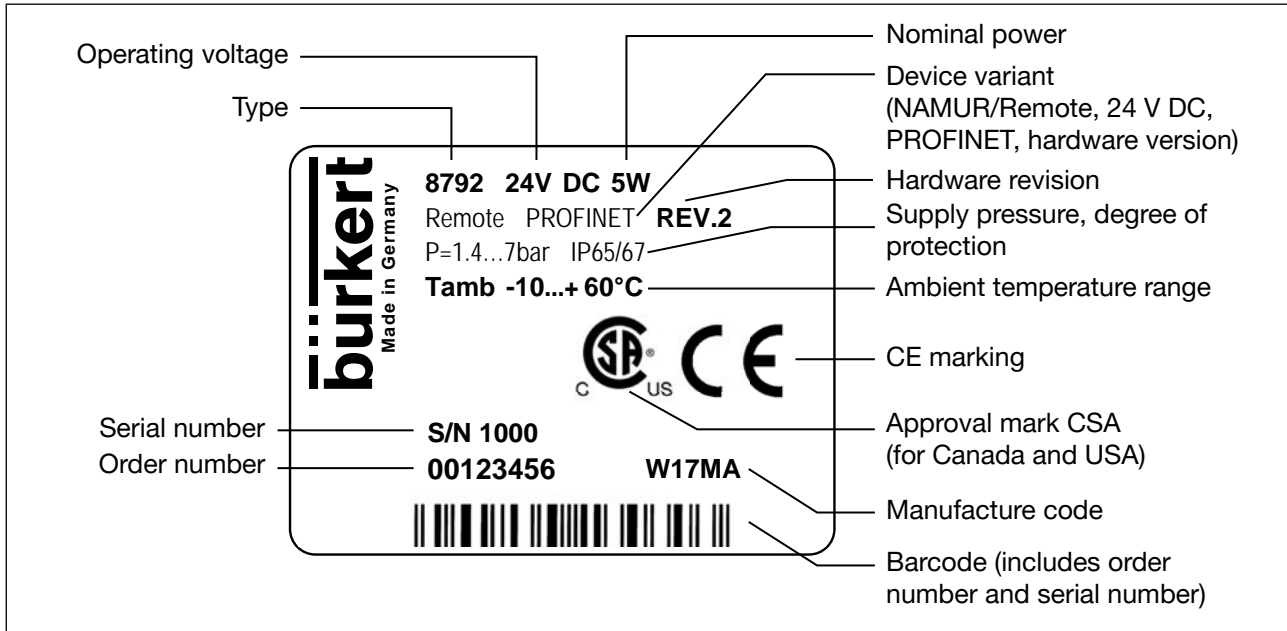

Figure 8: Example of type label

10.5 Mechanical data

Dimensions	see data sheet
Material	
Housing material	plastic-coated aluminum
Other external parts	stainless steel (V4A), PC, PE, POM, PTFE
Seal material	EPDM, NBR, FKM
Mass	approx. 1.0 kg

10.6 Electrical data

Connections	2 cable glands (M20 x 1.5) with connection terminals cable cross-sections rigid: 0.2...2.5 mm ² cable cross section flexible: 0.2...1.5 mm ² cable cross section AWG: 30...14 stripping length 6 mm or circular plug-in connector	
Operating voltage	24 V DC ±10% max. residual ripple 10%	
Power consumption	< 5 W	
Input data for actual value signal		
4 – 20 mA:	Input resistance	70 Ω
	Resolution	12 bit
Frequency:	Measurement range	0 – 1000 Hz
	Input resistance	20 kΩ
	Resolution	1‰ of measurement value,
	Input signal	> 300 mV _{ss}
	Waveform	Sine wave, square wave, triangle wave
Pt 100:	Measurement range	-20 to +220 °C
	Resolution	< 0.1 °C
	Measurement current	< 1 mA
Input data for set-point value signal		
0/4 – 20 mA:	Input resistance	70 Ω
	Resolution	12 bit
0 – 5/10 V:	Input resistance	20 kΩ at 0 – 5 V only 11 bit
	Resolution	12 bit
Protection class	III according to DIN EN 61140 (VDE 0140-1)	
Analog feedback		
max. current	10 mA (for voltage output 0 – 5/10 V)	
Load	0 – 560 Ω (for current output 0/4 – 20 mA)	
Inductive proximity switches	100 mA current limitation	
Digital outputs	galvanically isolated, PNP	
Current limitation	100 mA, output is clocked if overload occurs	
Digital input	PNP	
	0 – 5 V = logical “0”, 10 – 30 V = logical “1”	
	logic invertible in software	
	Input current approx. 10 mA at 24 V DC	
Communications interface	Connection to PC with USB bÜS interface set Communication with Bürkert Communicator	
Communication software	Bürkert Communicator (see “23 Accessories”)	

10.7 Pneumatic data

Control medium	Air, neutral gases Quality classes in accordance with ISO 8573-1
Dust content	Class 7, max. particle size 40 µm, max. particle density 10 mg/m ³
Water content	Class 3, max. pressure dew point -20 °C or min. 10 degrees below the lowest operating temperature
Oil content	Class X, max. 25 mg/m ³
Temperature range of compressed air	0 – +60 °C
Pressure range	1.4 – 7 bar
Air flow rate	50 I _N / min (at 1.4 bar*) for aeration and de-aeration 150 I _N / min (at 6 bar*) for aeration and de-aeration (Q _{Nn} = 100 I _N / min (according to definition for pressure drop from 7 to 6 bar absolute)).
Connections	Internal threads G1/4

* Pressure specifications: Overpressure with respect to atmospheric pressure

10.8 Safety end positions after failure of the electrical or pneumatic auxiliary power

The safety end position depends on the pneumatic connection of the actuator to the working connections A1 or A2.

Type of actuator	Designation	Safety end positions after failure of the auxiliary power	pneumatic auxiliary power
	single-acting Control function A	down → Connection according to "Figure 9"	down
		up → Connection according to "Figure 10"	
	single-acting Control function B	up → Connection according to "Figure 9"	up
		down → Connection according to "Figure 10"	
	double-acting Control function I	Connection according to "Figure 11"	not defined
		up = lower chamber of the actuator to A2	
		down = upper chamber of the actuator to A2	

Table 8: Safety end positions

Pneumatic connection: Description of "Table 8".

Single-acting actuators Control function A or B	Double-acting actuators Control function I
<p>Connect working connection A1 to actuator Close A2</p>	<p>Connect working connection A2 to actuator Close A1</p>
<p>Connect working connection A1 and A2 to actuator Safety end position: up = lower chamber to A2 down = upper chamber to A2</p>	

Figure 9:

Figure 10:

Figure 11:

11 ASSEMBLY



The dimensions of the positioner Type 8792/8793 and the different device variants can be found on the data sheet.

11.1 Safety instructions



WARNING

Risk of injury due to incorrect assembly.

- ▶ Assembly may only be carried out by authorized specialist personnel and using the appropriate tools.

Risk of injury due to unintentional switching on of the plant and uncontrolled start-up.

- ▶ Secure the device against accidental activation.
- ▶ Following assembly, ensure a controlled restart.

11.2 Attachment to a continuous valve with linear actuator according to NAMUR

The valve position is transferred to the position sensor installed in the positioner via a lever (according to NAMUR).

11.2.1 Attachment kit to linear actuator (order No. 787215)

(Can be purchased as an accessory from Bürkert).

Seq. No.	Quantity	Designation
1	1	NAMUR mounting bracket IEC 534
2	1	Hoop
3	2	Clamping piece
4	1	Driver pin
5	1	Conical roller
6a	1	NAMUR lever for stroke range 3 - 35 mm
6b	1	NAMUR lever for stroke range 35 - 130 mm
7	2	U-pin
8	4	Hexagon bolt DIN 933 M8 x 20
9	2	Hexagon bolt DIN 933 M8 x 16
10	6	Circlip DIN 127 A8
11	6	Washer DIN 125 B8.4
12	2	Washer DIN 125 B6.4
13	1	Spring VD-115E 0.70 x 11.3 x 32.7 x 3.5

Seq. No.	Quantity	Designation
14	1	Spring washer DIN 137 A6
15	1	Locking washer DIN 6799 - 3.2
16	3	Circlip DIN 127 A6
17	3	Hexagon bolt DIN 933 M6 x 25
18	1	Hexagon nut DIN 934 M6
19	1	Square nut DIN 557 M6
21	4	Hexagon nut DIN 934 M8
22	1	Guide washer 6.2 x 9.9 x 15 x 3.5

Table 9: Attachment kit on linear actuator

11.2.2 Assembly

! WARNING

Risk of injury due to incorrect assembly.

- ▶ Assembly may only be carried out by authorized specialist personnel and using the appropriate tools.

Risk of injury due to unintentional switching on of the plant and uncontrolled start-up.

- ▶ Secure the device against accidental activation.
- ▶ Following assembly, ensure a controlled restart.

Procedure:

→ Mount hoop ② with the aid of the clamping elements ③, hexagon bolts ⑰ and circlips ⑱ on the actuator spindle.

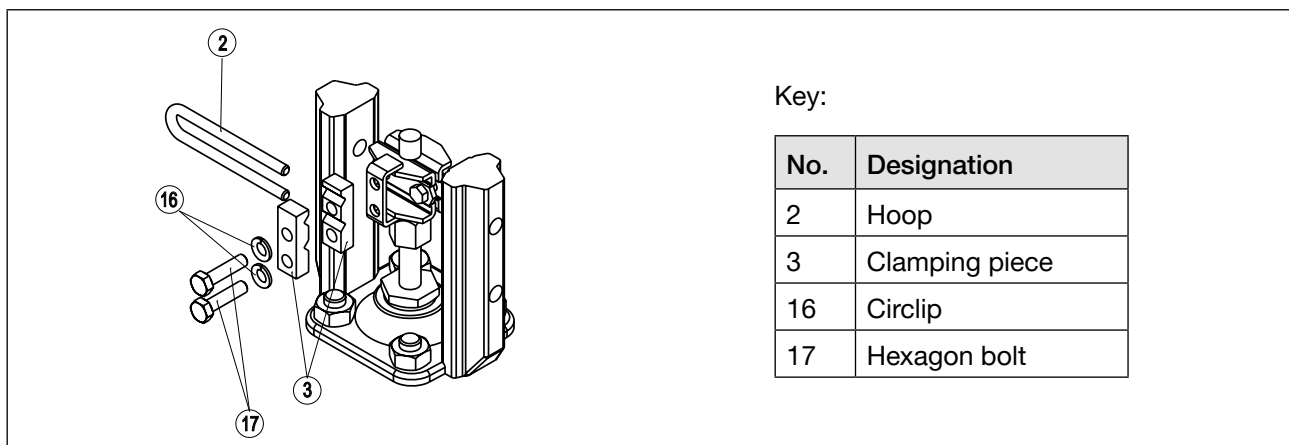

Figure 12: Assembling the hoop

- Select short or long lever according to the stroke of the actuator [“Table 9: Attachment kit on linear actuator”](#).
- Assemble lever (unless pre-assembled) (see [“Figure 13: Assembling the lever”](#)).

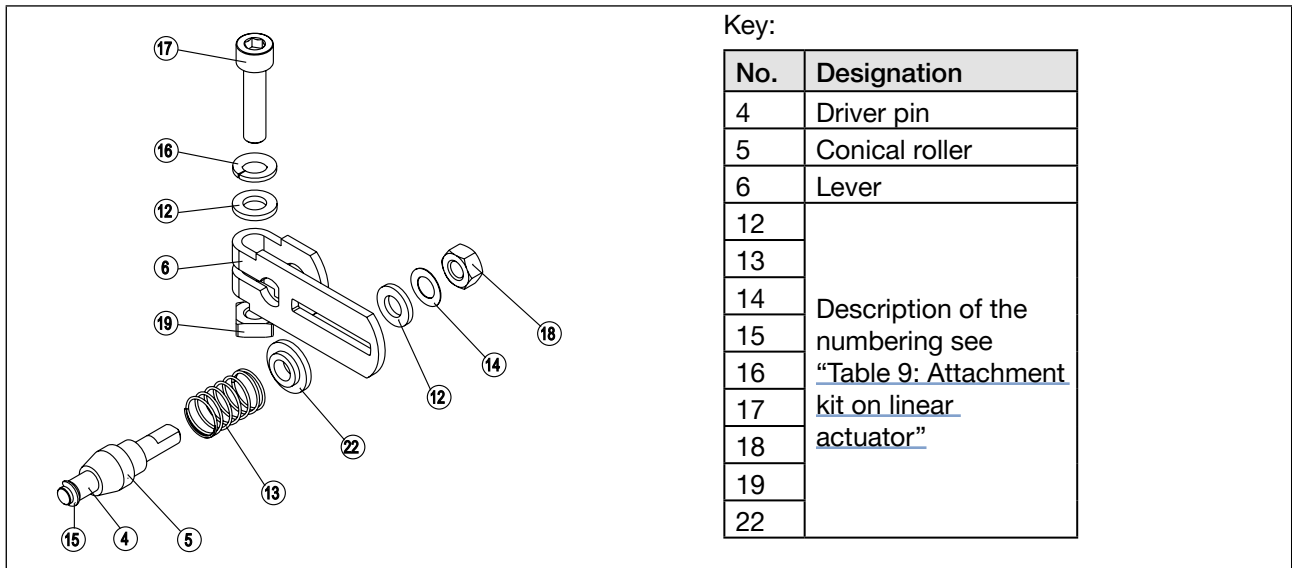

Figure 13: Assembling the lever

! The gap between the driver pin and the shaft should be the same as the actuator stroke. As a result, the lever has a swing range of 60° (see [“Figure 14: Swing range of the lever”](#)).

Rotation range of the position sensor:
The maximum rotation range of the position sensor is 180°.

Swing range of the lever:
To ensure that the position sensor operates at a good resolution, the swing range of the lever must be at least 30°.

The swing movement of the lever must be within the position sensor rotation range of 180°.

The scale printed on the lever is not relevant.

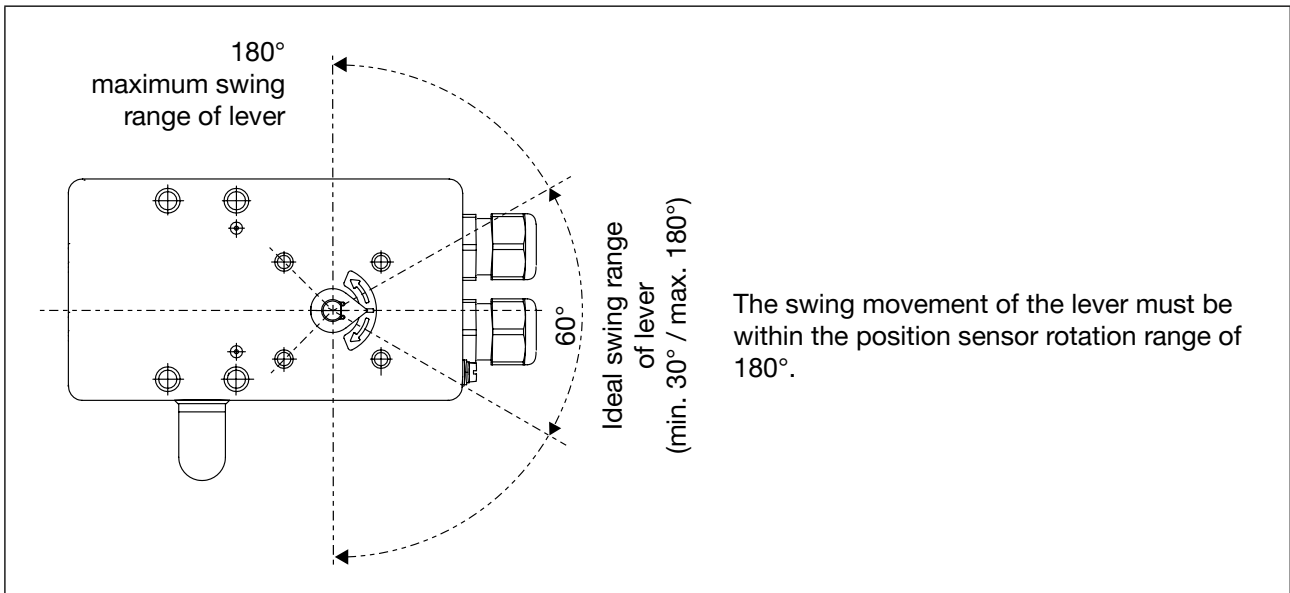

Figure 14: Swing range of the lever

→ Mount lever on the shaft of Type 8792/8793 and tighten.

11.2.3 Attaching the mounting bracket

→ Attach mounting bracket ① with hexagon bolts ⑨, circlips ⑩ and washers ⑪ to the rear side of Type 8792/8793 (see “Figure 15: Attaching the mounting bracket”).



The selection of the M8 thread used on the positioner depends on the size of the actuator.

→ To determine the correct position, hold the positioner with mounting bracket on the actuator.

The conical roller on the lever of the position sensor must be able to move freely in the hoop (see “Figure 15: Attaching the mounting bracket”) along the entire stroke range of the actuator. The lever position should be almost horizontally when the stroke is 50% (see chapter “11.2.4 Aligning the lever mechanism”).

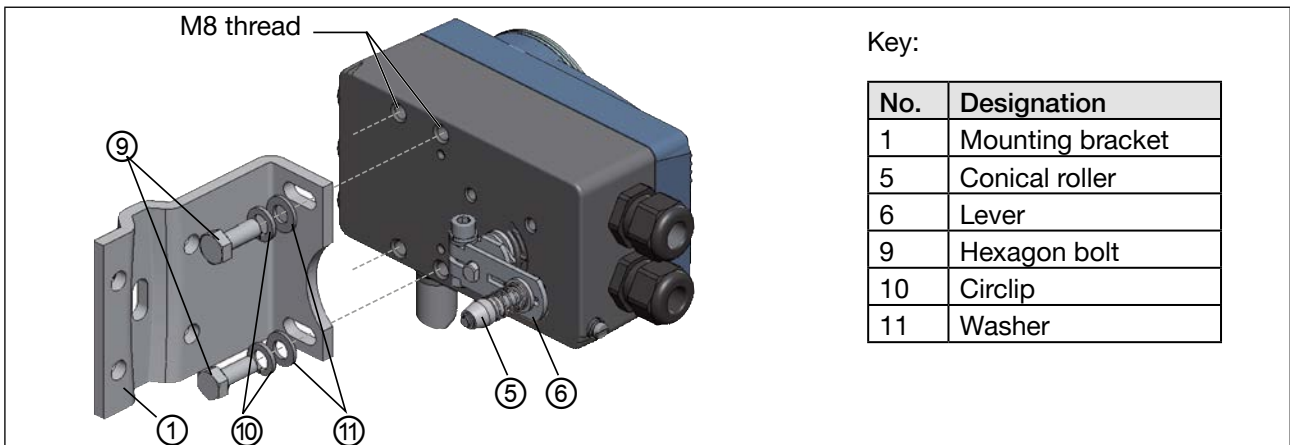

Figure 15: Attaching the mounting bracket

Attaching the Type 8792/8793 with mounting bracket for actuators with cast frame:

→ Attach mounting bracket to the cast frame with one or more hexagon bolts (8), washers (11) and circlips (10) (see “Figure 16”).

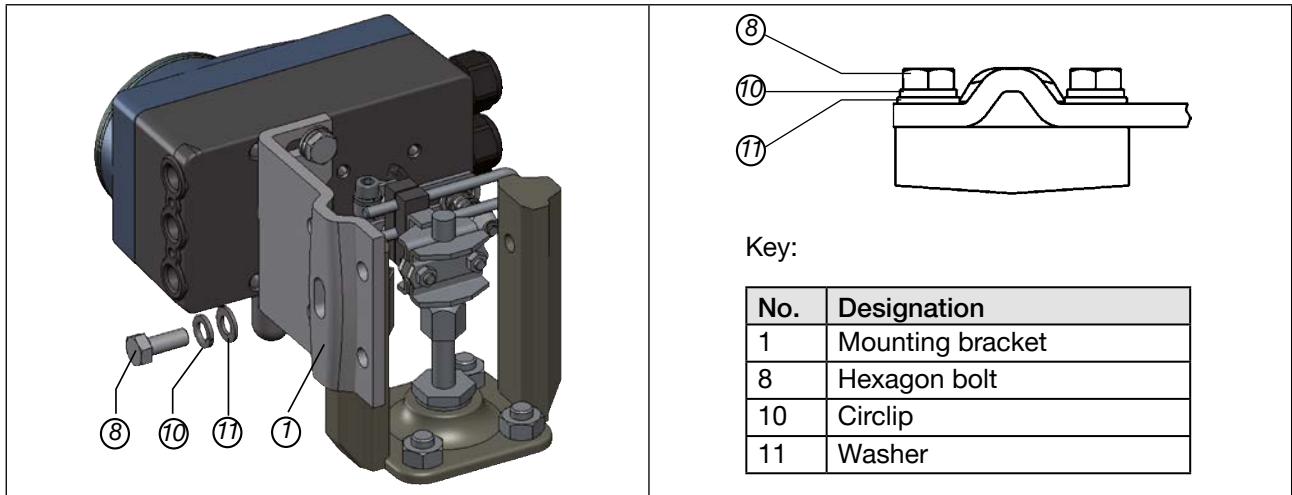

Figure 16: Attach positioner with mounting bracket; for actuators with cast frame

Attaching the Type 8792/8793 with mounting bracket for actuators with columnar yoke:

→ Attach mounting bracket to the columnar yoke (21) with the U-bolt (7), washers (11), circlips (10) and hexagon nuts (see “Figure 17”).

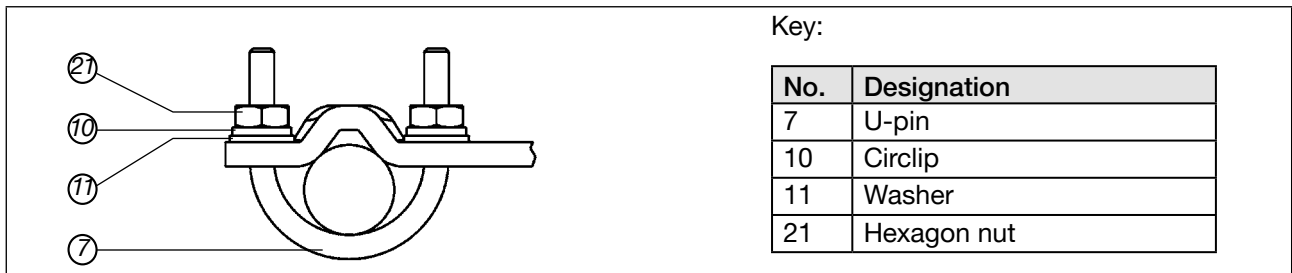

Figure 17: Attach positioner with mounting bracket; for actuators with columnar yoke

11.2.4 Aligning the lever mechanism

! The lever mechanism cannot be correctly aligned until the device has been connected electrically and pneumatically.

- Move the actuator in operating state MANU to half stroke (according to the scale on the actuator).
- Adjust the height of the positioner until the lever is horizontal.
- Fix the positioner in this position on the actuator.

11.3 Attachment to a continuous valve with rotary actuator

The shaft of the position sensor integrated in the positioner is connected directly to the shaft of the rotary actuator.

11.3.1 Attachment kit (as per VDI/VDE 3845) on the rotary actuator (order No. 787338).

(Can be purchased as an accessory from Bürkert).

Seq. No.	Quantity	Designation
1	1	Adapter
2	2	Setscrew DIN 913 M4 x 10
3	4	Hexagon bolt DIN 933 M6 x 12
4	4	Circlip B6
5	2	Hexagon nut DIN 985 M4

Table 10: Attachment kit on rotary actuator

Other accessories:

For the order number for the assembly bridge with fastening screws (as per VDI/VDE 3845), please refer to the data sheet for Type 8792/8793.

11.3.2 Assembly



WARNING

Risk of injury due to incorrect assembly.

- ▶ Assembly may only be carried out by authorized specialist personnel and using the appropriate tools.

Risk of injury due to unintentional switching on of the plant and uncontrolled start-up.

- ▶ Secure the device against accidental activation.
- ▶ Following assembly, ensure a controlled restart.

Procedure:

- Define the attachment position of Type 8792/8793:
 - in parallel to the actuator or
 - rotated by 90° to the actuator.
- Determine the home position and the direction of rotation of the actuator.
- Fit adaptor to the shaft of Type 8792/8793 and attach with 2 setscrews.



Anti-twist safeguard:

Note the flat side of the shaft. One of the setscrews must be situated on the flat side of the shaft as an anti-twist safeguard (see "Figure 18").

Rotation range of the position sensor:

The maximum rotation range of the position sensor is 180°. The shaft of Type 8792/8793 may be moved within this range only.

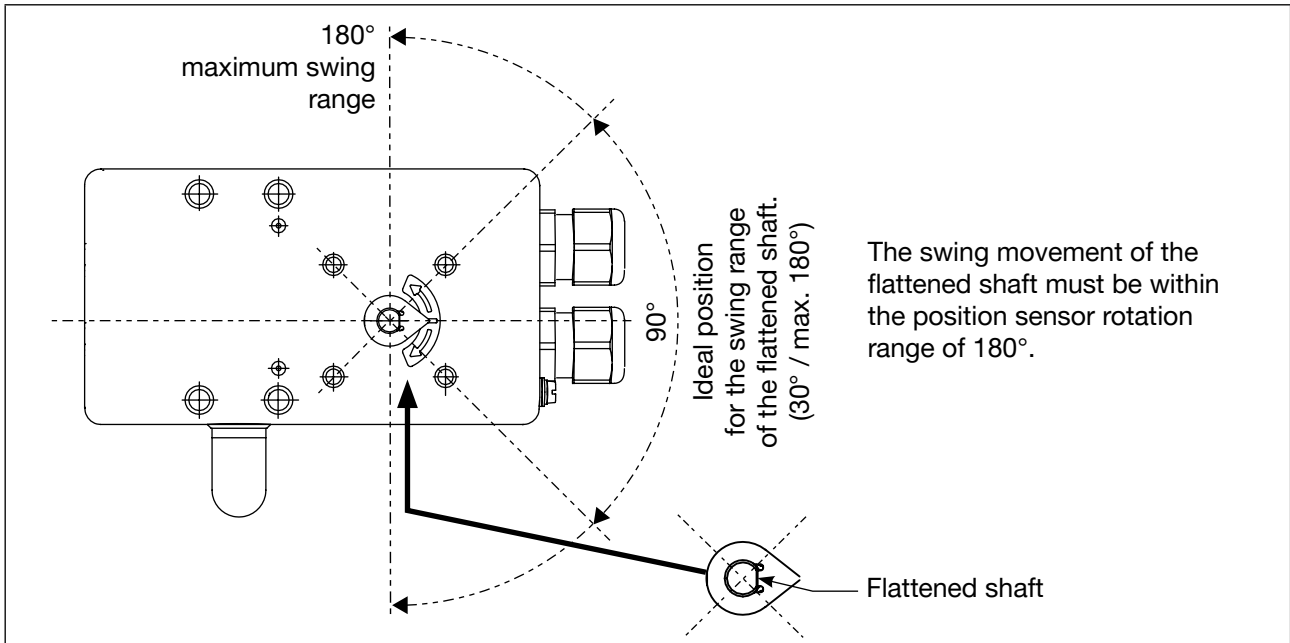

Figure 18: Rotation range / anti-twist safeguard

→ Set up the multi-part assembly bridge* to suit the actuator.

→ Attach the assembly bridge by 4 hexagon bolt ③ and circlips ④ to Type 8792/8793 (see “Figure 19”).

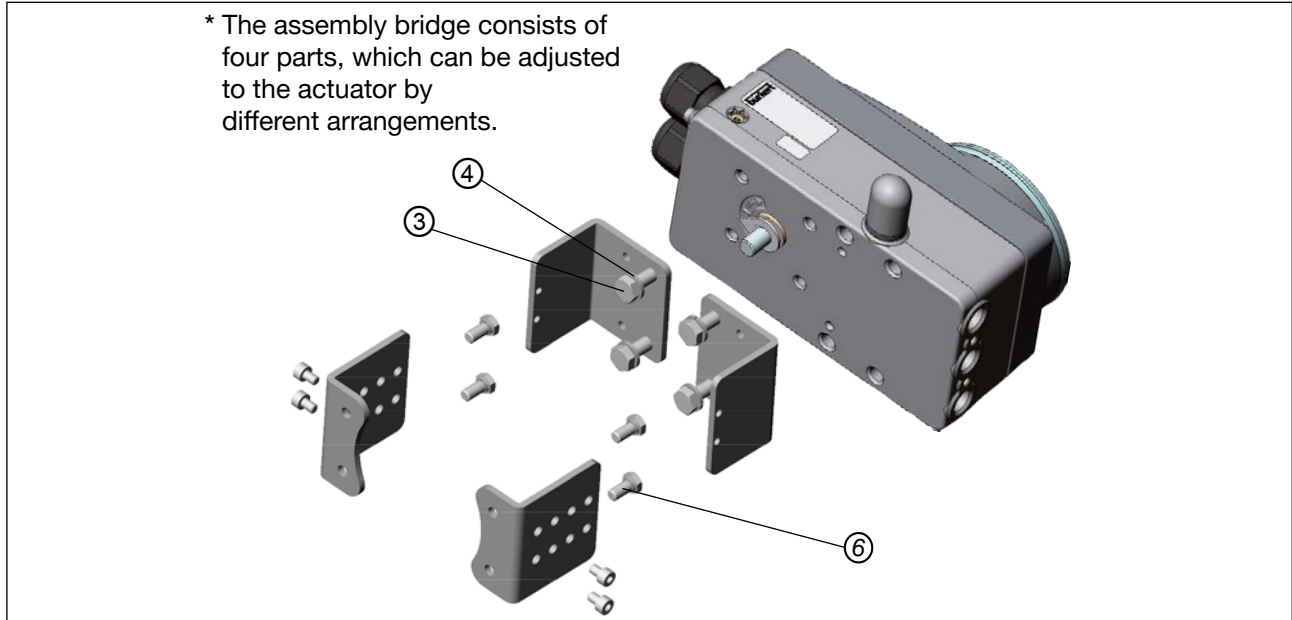

Figure 19: Attaching the assembly bridge (schematic representation)

→ Place Type 8792/8793 with assembly bridge on the rotary actuator and attach by 4 hexagon bolts ⑥ (see “Figure 20”).

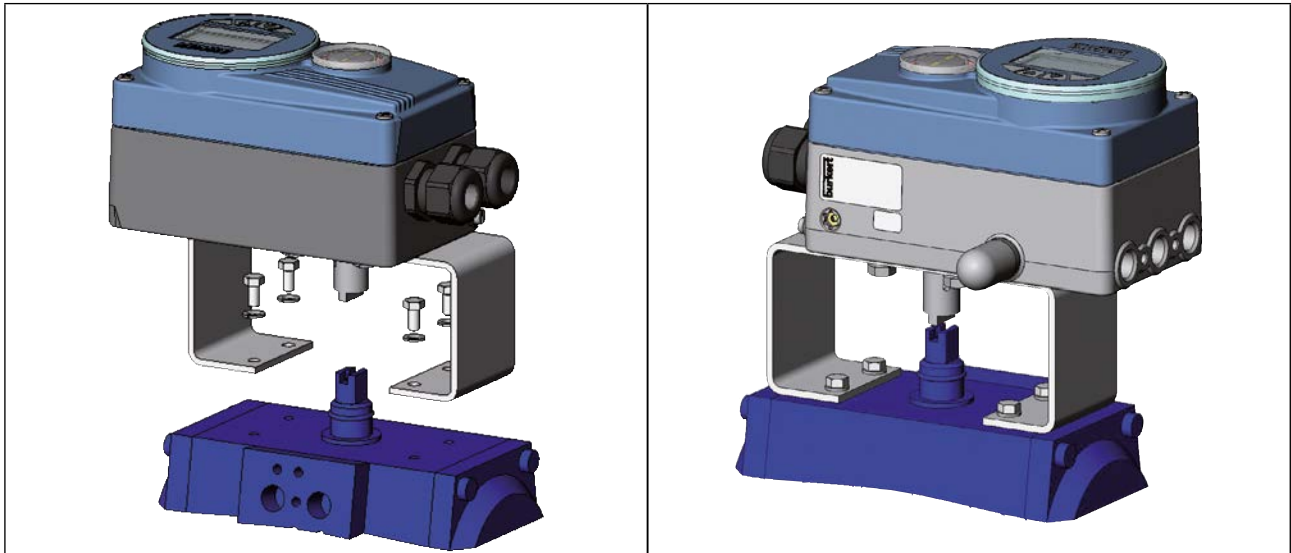

Figure 20: Swivel actuator attachment

! If the X.TUNE ERROR 5 message is indicated after the X.TUNE function starts, the shaft of Type 8792/8793 is not correctly aligned with the shaft of the actuator (see “Error message for P.Q.’LIN; process controller Type 8793” on page 191).

- Check alignment (as described previously in this chapter).
- Then repeat the X.TUNE function.

11.4 Remote operation with external position sensor

In the case of this variant, the positioner has no position sensor in the form of a rotary position sensor, but an external position sensor.

Depending on the variant of Type 8792/8793, there are the following connection variants:

Device type	Interface	Position sensor	Setting in the menu (ADD.FUNCTION)
Type 8792 Remote	digital (serial)	Remote sensor Type 8798	–
Type 8793 Remote	digital (serial)	Remote sensor Type 8798	POS.SENSOR → DIGITAL For menu description see chapter “16.1.21 POS.SENSOR”
	analog (4 – 20 mA) *	any high-resolution position sensor	POS.SENSOR → ANALOG For menu description see chapter “16.1.21 POS.SENSOR”

Table 11: Connection variants of external position sensor



* If the external position sensor is connected to the process controller Type 8793 via the analog interface, it can be operated only as a positioner (position controller).

11.4.1 Mounting accessories

There are two options of attaching the Type 8792/8793 in remote operation (see “Figure 21”).

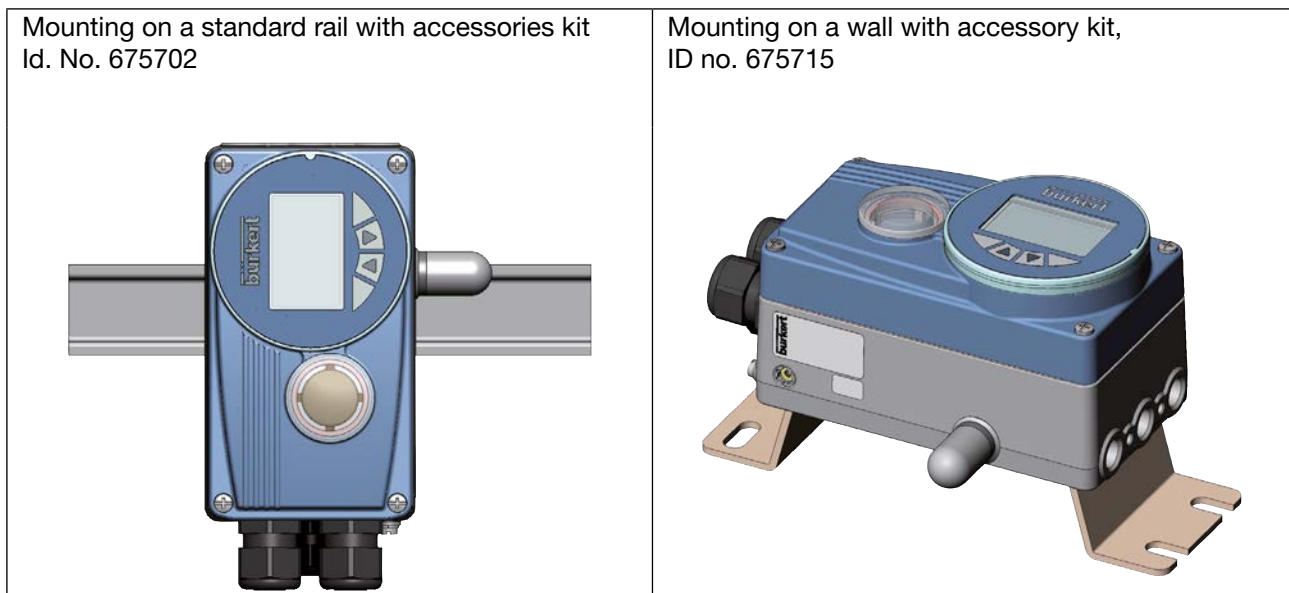

Figure 21: Attachment types in remote operation

11.4.2 Connection and start-up of the remote sensor Type 8798

WARNING

Risk of injury due to improper start-up.

- ▶ Start-up may be carried out by authorized technicians only and with the appropriate tools.

Risk of injury due to unintentional switching on of the plant and uncontrolled start-up.

- ▶ Secure the device against accidental activation.
- ▶ Following assembly, ensure a controlled restart.

→ Connect the 3 or 4 wires of the sensor cable to the designated screw-type terminals of Type 8792/8793.
Connection of screw-type terminals: See chapter "[12.2.2.4. Terminal assignment for external position sensor \(for remote variant only\)](#)" on page 51

Connection of M8 circular plug (only for Ethernet (Ethernet/IP, PROFINET I/O, Modbus TCP) and büS):
See chapter "[19.4.5 X4: M8 socket, 4-pin, optional - Remote sensor \(for remote variant only\)](#)" on page 170

- Mount remote sensor on the actuator.
The proper procedure is described in the summary instructions of remote sensor Type 8798.
- Connect compressed air to the positioner.
- Connect positioner pneumatically to the actuator.
- Switch on the operating voltage of Type 8792/8793:
- Run the *X.TUNE* function.

11.4.3 Connection and start-up of an external 4 – 20 mA position sensor (only for Type 8793 remote variant)

 **Process controller Type 8793 can only be used as a positioner (position controller) when an external position sensor 4 – 20 mA is connected as the process actual value input is used as the input for the external position sensor.**

It is generally possible to connect any position sensor having an output 4 – 20 mA that has an appropriate resolution of the position signal.

Good control characteristics are achieved when the resolution of the position sensor allows at least 1,000 measurement steps along the path to be detected.

Example: Position sensor with measurement range 150 mm;
thereof measurement range used (= stroke) 100 mm

Required minimum sensor resolution:

$$\frac{100 \text{ mm}}{1000 \text{ steps}} = 0.1 \text{ mm}$$

WARNING
Risk of injury due to improper start-up.

- ▶ Start-up may be carried out by authorized technicians only and with the appropriate tools.

Risk of injury due to unintentional switching on of the plant and uncontrolled start-up.

- ▶ Secure the device against accidental activation.
- ▶ Following assembly, ensure a controlled restart.

→ Connect the external position sensor 4 – 20 mA with terminals 1 - 4 of the process controller Type 8793 remote variant. (See chapter [“12.2.3.1. Terminal assignments of the process actual value input”](#))

Internal supply of the external position sensor by Type 8793:

→ connection according to input type “4 – 20 mA - internally supplied”

Separate supply of the external position sensor:

→ connection according to input type “4 – 20 mA - externally supplied”.

→ Attach external position sensor on the actuator.

The proper procedure is described in the instructions of the external position sensor.

→ Connect the compressed air to Type 8793.

→ Connect Type 8793 pneumatically to the actuator.

→ Switch on operating voltage of Type 8793.

→ To achieve the best-possible control accuracy, set the external position sensor such that the past to be detected corresponds to the signal range 4 – 20 mA (only if the external position sensor includes this function).

→ In the *ADD.FUNCTION* menu activate the *POS.SENSOR* function. Then select *POS.SENSOR* in the main menu and set *ANALOG* (see chapter [“16.1.21 POS.SENSOR”](#) on page 120).

→ Run the *X.TUNE* function.

11.5 Pneumatic connection

11.5.1 Safety instructions

! DANGER

Risk of injury from high pressure in the system.

- ▶ Before loosening lines and valves, turn off the pressure and vent the lines.

! WARNING

Risk of injury from improper installation.

- ▶ Installation may be carried out by authorized technicians only and with the appropriate tools.

Risk of injury due to unintentional switching on of the plant and uncontrolled start-up.

- ▶ Secure the device against accidental activation.
- ▶ Following installation, ensure a controlled restart.

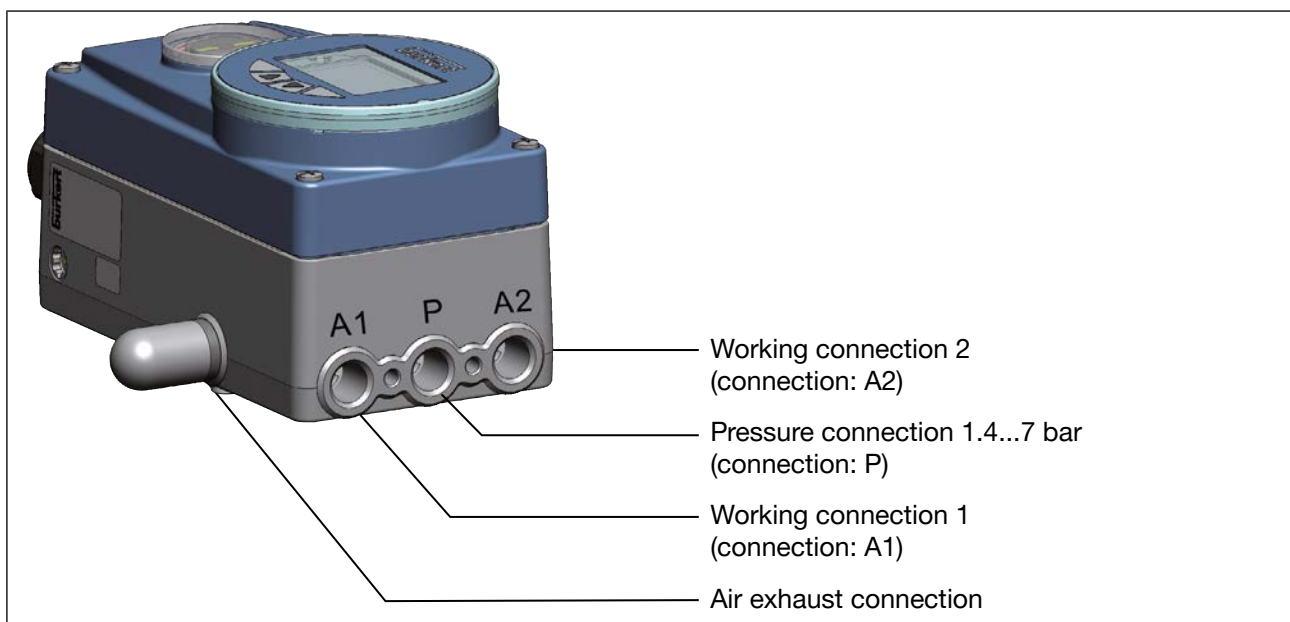

Figure 22: Fluid installation / Location of the connections

Procedure:

→ Apply supply pressure (1.4 – 7 bar) to the pressure connection P.

For single-acting actuators (control function A and B):

→ Connect one working connection (A1 or A2, depending on required safety end position) to the chamber of the single-acting actuator.

See chapter [“10.8 Safety end positions after failure of the electrical or pneumatic auxiliary power”](#).

→ Seal a working connection which is not required with a plug.

For double-acting actuators (control function I):

→ Connect working connections A1 and A2 to the respective chambers of the double-acting actuator.
See chapter [“10.8 Safety end positions after failure of the electrical or pneumatic auxiliary power”](#)



Important information for perfect control behavior.

In order to ensure that the control behavior is not negatively affected in the upper stroke range on account of too little pressure difference

- keep the applied supply pressure always 0.5 – 1 bar above the pressure which is the minimum required to move the pneumatic actuator to its end position.

If fluctuations are greater, the controller parameters measured with the *X.TUNE* function are not optimal.

- During operation keep the fluctuations of the supply pressure as low as possible (max. $\pm 10\%$).

12 ELECTRICAL INSTALLATION

There are 2 connection variants for Type 8792, 8793:

- Multipole with circular plug-in connector
- Cable gland with connection terminals

Signal values

Operating voltage: 24 V DC

Set-point value
(process/position controller): 0 – 20 mA; 4 – 20 mA
0 – 5 V; 0 – 10 V

Actual value
(only process controller): 4 – 20 mA;
frequency;
Pt 100

12.1 Electrical installation with circular plug-in connector (multipole variant)



DANGER

Risk of injury from electric shock.

- ▶ Before reaching into the device or the equipment, switch off the power supply and secure to prevent reactivation.
- ▶ Observe applicable accident prevention and safety regulations for electrical equipment.



WARNING

Risk of injury from improper installation.

- ▶ Installation may be carried out by authorized technicians only and with the appropriate tools.

Risk of injury due to unintentional switching on of the plant and uncontrolled start-up.

- ▶ Secure the device against accidental activation.
- ▶ Following installation, ensure a controlled restart.



Use of the set-point value input 4 – 20 mA

If several devices of Type 8792/8793 are connected in series and the power supply to a device in this series connection fails, the input of the failed device becomes highly resistive. As a result, the 4 – 20 mA standard signal fails. In this case please contact Bürkert Service directly.

With Ethernet (EtherNet/IP, PROFINET I/O, Modbus TCP), PROFIBUS DPV1 or bÜS)
Please find the designations of the circular plug-in connectors, sockets and contacts in the respective chapters.

12.1.1 Type 8792 - designation of the circular plug-in connectors

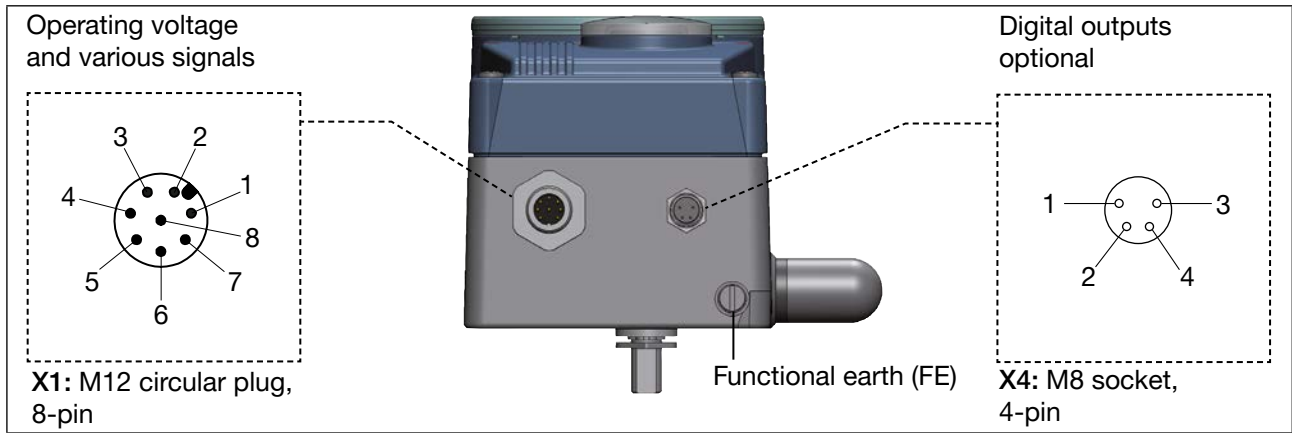

Figure 23: Type 8792; designation of the circular plug-in connectors and contacts

12.1.2 Connection of positioner Type 8792

→ Connect pins according to the variant (options) of the positioner.

12.1.3 X1: M12 circular plug, 8-pin

Pin	Wire color*	Assignment	On the device side	External circuit / signal level
Input signals from the control center (e.g. PLC)				
1	white	Set-point value + (0 / 4 – 20 mA or 0 – 5 / 10 V)	1 ○ — + (0/4 – 20 mA or 0 – 5/10 V) fully galvanically isolated	
2	brown	Set-point value	2 ○ — GND set-point value	
5	gray	Digital input	5 ○ — +	0...5 V (logical 0) 10...30 V (logical 1)
6	pink	Digital input GND	6 ○ — GND (identical to GND operating voltage)	
Output signals to the control center (e.g. PLC) - (assigned for the analog output option only)				
8	red	Analog feedback +	8 ○ — + (0/4 – 20 mA or 0 – 5/10 V) fully galvanically isolated	
7	blue	Analog feedback GND	7 ○ — GND analog feedback	
Operating voltage				
3	green	GND	3 ○ —	24 V DC ±10 % max. residual ripple 10 %
4	yellow	+ 24 V	4 ○ —	
* The indicated wire colors refer to the connection cable, ID no. 919061, available as an accessory.				

Table 12: X1 - M12 circular plug, 8-pin

12.1.3.1. X4: M8 socket, 4-pin (for the digital output option only) output signals to the control center (e.g. PLC)



Pin	Assignment	On the device side	External circuit / signal level
1	Digital output 1	1 	0 – 24 V
2	Digital output 2	2 	0 – 24 V
3	Digital output GND	3 	GND (identical to GND operating voltage)

Table 13: Pin assignment; X4 - M8 socket, 4-pin - output signals to the control center

When the operating voltage is applied, the positioner is operating.

→ Now make the required basic settings and actuate the automatic adjustment of the positioner. The procedure is described in chapter “14 Start-up” on page 65.

12.1.4 Type 8793 - designation of the circular plug-in connectors and contacts

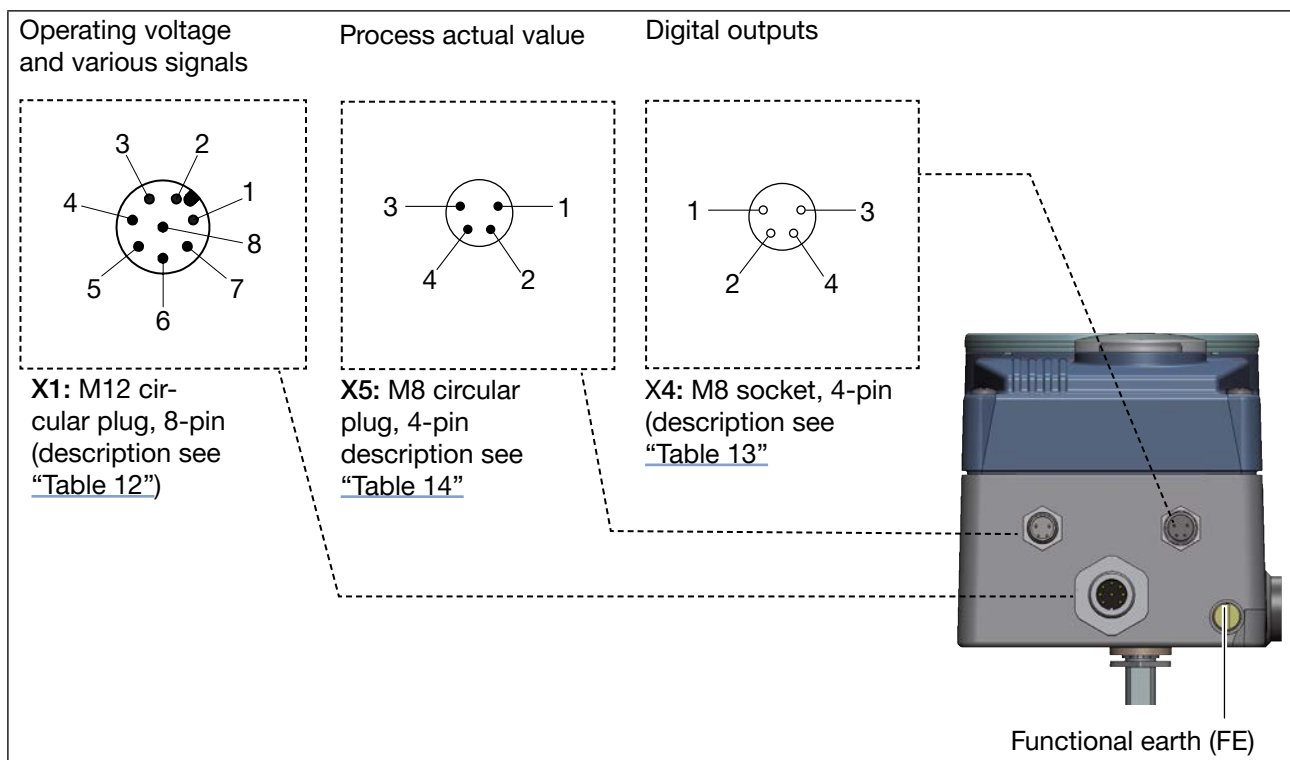

Figure 24: Type 8793; designation of the circular plug-in connectors and contacts

Location of the switch:

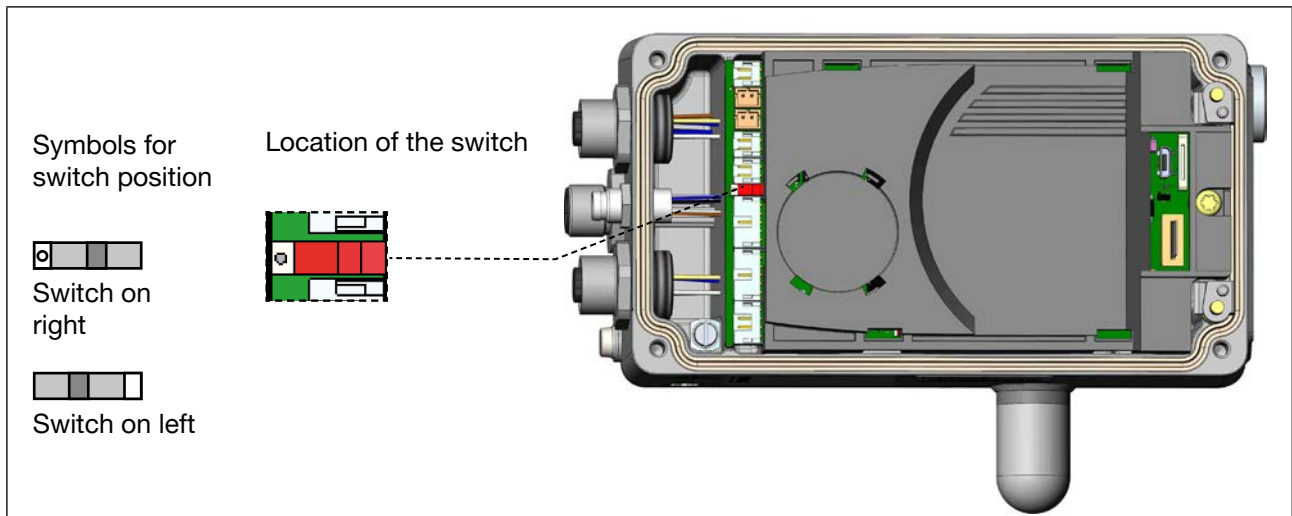



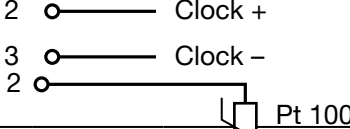
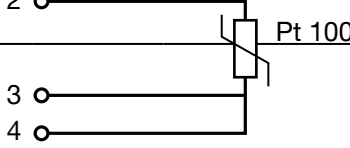

Figure 25: Location of the switch; symbols for switch position

12.1.5 Connection of the process controller Type 8793

→ First connect the process controller as described in chapter “12.1.2” to “12.1.4”.

12.1.6 X5: M8 circular plug, 4-pin, input signals process actual value (for Type 8793 only)

Input type*	Pin	Assignment	Switch ***	On the device side	External circuit
4 – 20 mA - internally supplied	1 2 3 4	+24 V transmitter power supply Output from transmitter GND (identical to GND operating voltage) Bridge after GND (GND from 3-conductor transmitter)	 Switch on left		
4 – 20 mA - externally supplied	1 2 3 4	Not assigned Process actual + Not assigned Process actual -	 Switch on right		
Frequency - internally supplied	1 2 3 4	+24 V sensor power supply Clock input + Clock input – (GND) Not assigned	 Switch on left		

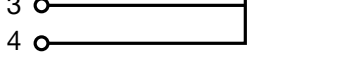
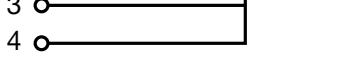
Input type*	Pin	Assignment	Switch ***	On the device side	External circuit
Frequency - externally supplied	1	Not assigned	 Switch on right		
	2	Clock input +			
	3	Clock input -			
	4	Not assigned			
Pt 100 (see infor- mation below)	1	Not assigned	 Switch on right		
	2	Pt 100 power supply			
	3	Pt 100 GND			
	4	Pt 100 compensation			

* Can be adjusted via software (see chapter [“15.2.1 PV-INPUT – Specifying signal type for the process actual value”](#) on page 71).

** The indicated wire colors refer to the connection cable, ID no. 92903474, available as an accessory.

*** Position of the switch, see [“Figure 25: Location of the switch; symbols for switch position”](#)

Table 14: X5 - M8 circular plug, 4-pin, input signals process actual value (for Type 8793 only)

! For reasons of wire compensation connect the Pt 100 sensor via 3 wires.
Always bridge Terminal 3 and Terminal 4 on the sensor.

When the operating voltage is applied, the process controller is operating.

→ Now make the required basic settings and actuate the automatic adjustment of the process controller.
The procedure is described in chapter [“14 Start-up”](#) on page 65.

12.1.7 Switch position (only type 8793)

For the “internally supplied” input type, the GND signal of the process actual value must be connected to the GND signal of the operating voltage. A bridge is established internally between both GND signals using the “left” switch position.

Supplied	Assignment	Switch position
Internally supplied	GND process actual value equal to GND operating voltage	Switch on left
Externally supplied	GND process actual value electrically isolated from GND operating voltage	Switch on right

Table 15: Switch position

! The description EtherNet/IP, PROFINET and Modbus TCP can be found in chapter [“19”](#).
The description bÜS option can be found in chapter [“20”](#).
The description PROFIBUS DPV1 can be found in chapter [“21”](#).

12.2 Electrical installation with cable gland

DANGER

Risk of injury from electric shock.

- ▶ Before reaching into the device or the equipment, switch off the power supply and secure to prevent reactivation.
- ▶ Observe applicable accident prevention and safety regulations for electrical equipment.

WARNING

Risk of injury from improper installation.

- ▶ Installation may be carried out by authorized technicians only and with the appropriate tools.

Risk of injury due to unintentional switching on of the plant and uncontrolled start-up.

- ▶ Secure the device against accidental activation.
- ▶ Following installation, ensure a controlled restart.

Use of the set-point value input 4 – 20 mA

If several devices of Type 8792/8793 are connected in series and the power supply to a device in this series connection fails, the input of the failed device becomes highly resistive.

As a result, the 4 – 20 mA standard signal fails.

In this case please contact Bürkert Service directly.

12.2.1 Terminal board Type 8792/8793 with screw-type terminals

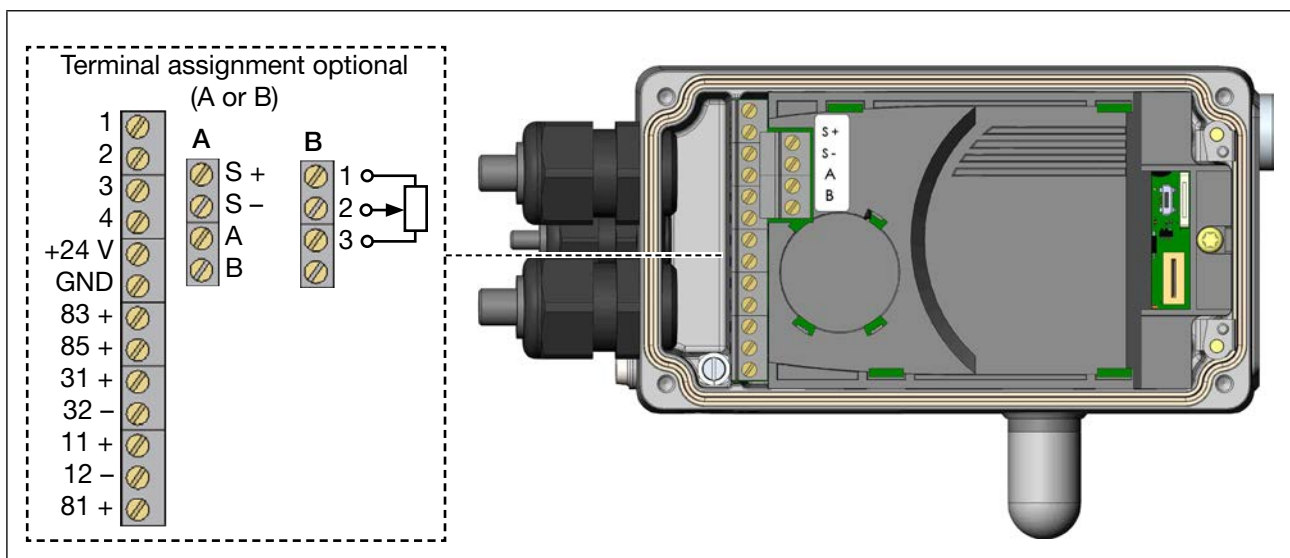

Figure 26: Designation of the screw-type terminals

Procedure:

→ Unscrew the 4 screws of the housing cover and remove the cover.

The screw-type terminals are now accessible.

→ Connect Type 8792/8793.

The procedure is described in the following chapters

for Type 8792: Chapter [“12.2.2 Terminal assignment for cable gland - Type 8792”](#)

for Type 8793: Chapter [“12.2.3 Terminal assignment for cable gland - Type 8793”](#).

12.2.2 Terminal assignment for cable gland - Type 8792

12.2.2.1. Input signals from the control center (e.g. PLC)



Terminal	Assignment	On the device side	External circuit / signal level
11 +	Set-point value +	11 + 	(0/4...20 mA or 0...5/10 V) fully galvanically isolated
12 -	Set-point value GND	12 - 	GND set-point value
81 +	Digital input +	81 + 	<div style="display: flex; align-items: center;"> <div style="margin-right: 10px;">+</div>  <div style="margin-left: 10px;"> <p>0...5 V (logical 0)</p> <p>10...30 V (logical 1)</p> <p>specific to operating voltage GND (terminal GND)</p> </div> </div>

Table 16: Terminal assignment; input signals of the control center

12.2.2.2. Terminal assignment: Output signals to the control center (e.g. PLC) - (required for analog output and/or digital output option only)

→ Connect terminals according to the variant (options) of the positioner.



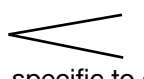

Terminal	Assignment	On the device side	External circuit / signal level
83 +	Digital output 1	83 + 	24 V / 0 V, NC / NO specific to operating voltage GND (terminal GND)
85 +	Digital output 2	85 + 	24 V / 0 V, NC / NO specific to operating voltage GND (terminal GND)
31 +	Analog feedback +	31 + 	+ (0/4...20 mA or 0...5/10 V) fully galvanically isolated
32 -	Analog feedback GND	32 - 	GND analog feedback

Table 17: Terminal assignment; output signals to the control center

12.2.2.3. Operating voltage



Terminal	Assignment	On the device side	External circuit / signal level
+ 24 V	Operating voltage +	+ 24 V DC 	24 V DC ±10% max. residual ripple 10%
GND	Operating voltage GND	GND 	

Table 18: Terminal assignment; operating voltage

12.2.2.4. Terminal assignment for external position sensor (for remote variant only)

Connection of the digital, non-contacting position sensor Type 8798:

Terminal	Wire color		Assignment	On the device side	External circuit / signal level
	Cable type 1	Cable type 2			
S +	brown	brown	Supply sensor +	S + ○ — +	
S -	white	black	Supply sensor -	S - ○ — -	
A	green	red	Serial interface, A cable	A ○ — A cable	
B	yellow	orange	Serial interface, B cable	B ○ — B cable	

Table 19: Terminal assignment; digital, non-contacting position sensor Type 8798

Connection of a potentiometric position sensor:

Terminal	Assignment	On the device side	External circuit
	Potentiometer 1	1 ○ —	
	Sliding contact 2	2 ○ —	
	Potentiometer 3	3 ○ —	

Table 20: Terminal assignment; potentiometric position sensor

MAN 1000341264 EN Version: F Status: RL (released | freigegeben) printed: 01.09.2023

12.2.3 Terminal assignment for cable gland - Type 8793

→ First connect the process controller as described in chapter “12.2.2 Terminal assignment for cable gland - Type 8792”.

12.2.3.1. Terminal assignments of the process actual value input

Input type*	Terminal	Assignment	On the device side	External circuit
4 – 20 mA - internally supplied	actual value	1		
		2		
		3		
		4		
	GND	GND from operating voltage		
4 – 20 mA - externally supplied	actual value	1		
		2	2	+ (4 – 20 mA)
		3	3	GND 4 – 20 mA
		4		
Frequency -internally supplied	actual value	1	1	+24 V
		2	2	Clock +
		3		
		4	4	Clock -
	GND	GND from operating voltage	GND	Clock - (GND)
Frequency - externally supplied	actual value	1		
		2	2	Clock +
		3		
		4	4	Clock -
Pt 100 (see information below)	actual value	1		
		2	2	
		3	3	
		4	4	

*Can be adjusted via software (see chapter “15.2.1 PV-INPUT – Specifying signal type for the process actual value” on page 71).

Table 21: Terminal assignments of the process actual value input



**For reasons of wire compensation connect the Pt 100 sensor via 3 wires.
Always bridge Terminal 3 and Terminal 4 on the sensor.**

When the operating voltage is applied, the process controller is operating.

→ Now make the required basic settings and actuate the automatic adjustment of the process controller.
The procedure is described in chapter “14 Start-up” on page 65.

13 OPERATION

WARNING

Danger due to improper operation.

Improper operation may result in injuries as well as damage to the device and its environment.

- ▶ The operating personnel must know and have understood the contents of the operating instructions.
- ▶ Observe the safety instructions and intended use.
- ▶ Only adequately trained personnel may operate the equipment/the device.

There is the process level and the setting level for the operation and setting of Type 8792/8793.

Process level:

The running process is displayed and operated on the process level.

Operating state: AUTOMATIC – Displaying the process data
 MANU – Manual opening and closing of the valve

Setting level:

The basic settings for the process are made on the setting level.

- Inputting the operating parameters
- Activating auxiliary functions

If the device is in the AUTOMATIC operating state when changing to the setting level, the process continues running during the setting.

13.1 Description of the operating and display elements

The device features 4 keys for operation and a 128x64 dot matrix graphics display as the display element.

The display is adjusted to the set functions and operating levels.

In principle, a distinction can be made between the display view for the process level and the setting level. When the operating voltage has been applied, the process level is displayed.

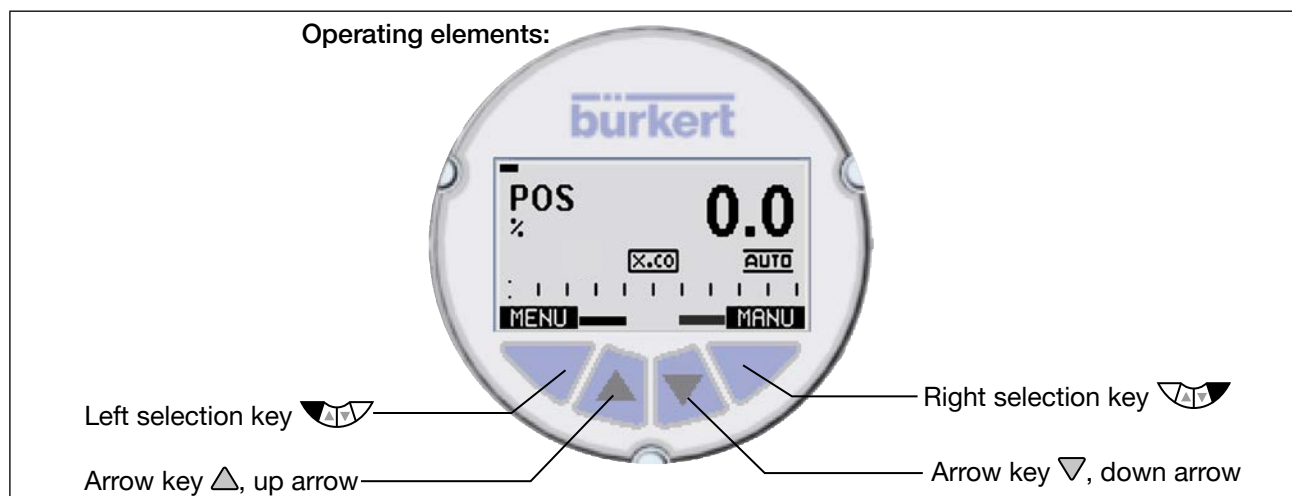

Figure 27: Operating elements

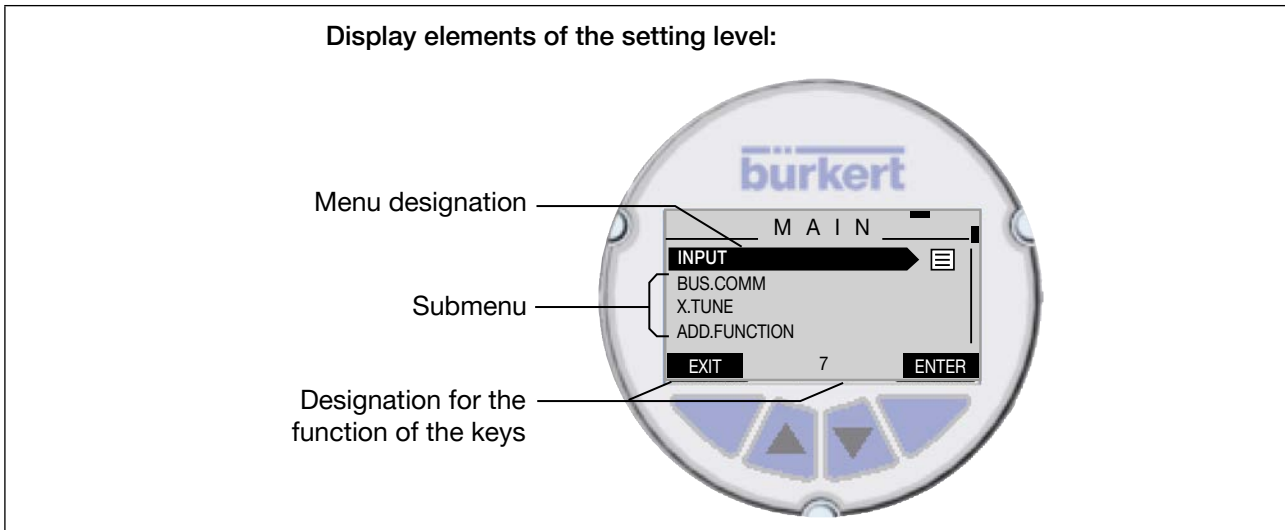

Figure 28: Display elements of the setting level

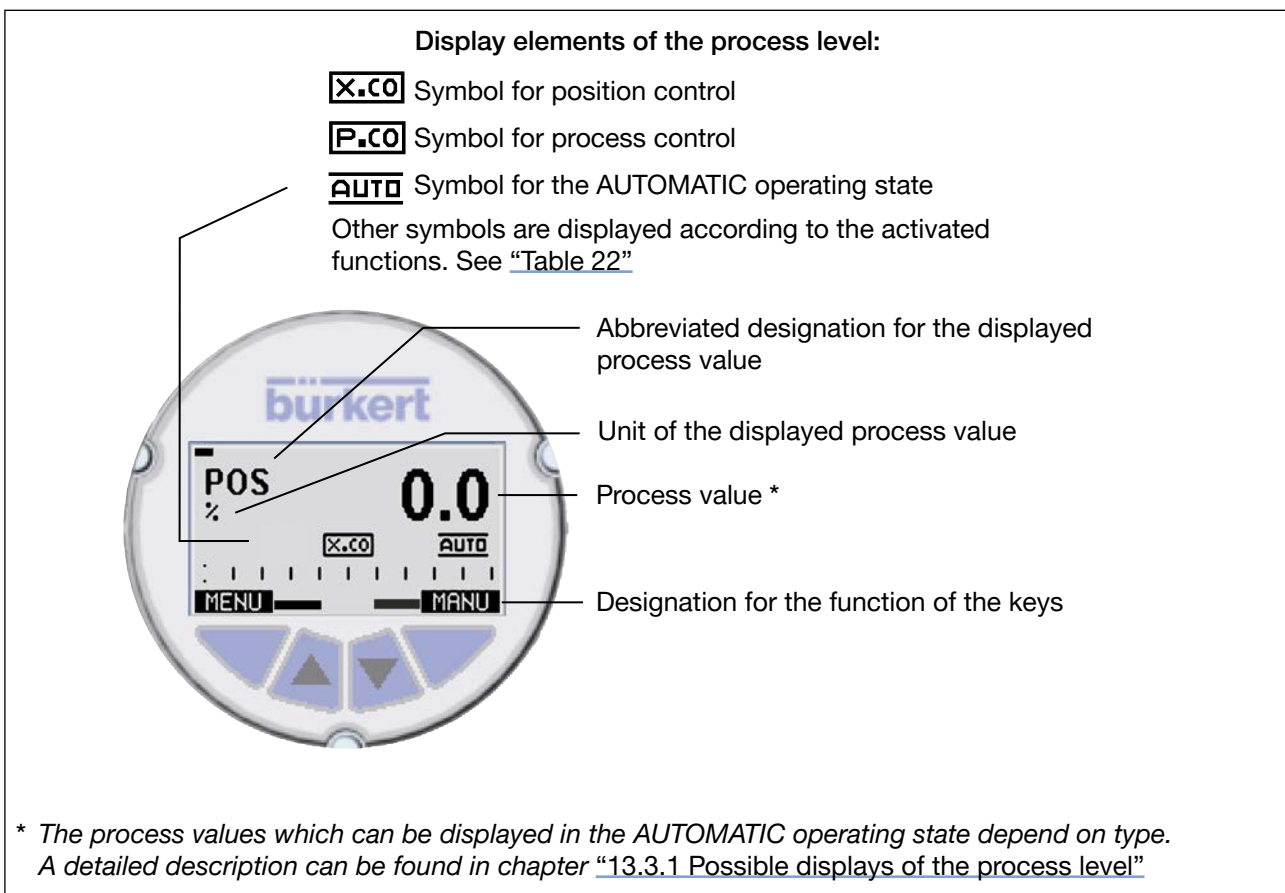

Figure 29: Display elements of the process level

13.1.1 Description of the symbols which are displayed on the process level

The symbols which are displayed depend on

- type,
- operation as position or process controller,
- AUTOMATIC or MANU operating state and
- the activated functions.











Operation	Icon	Description
Types 8792/8793		AUTOMATIC operating state
Operation as position controller		Diagnostics active (optional; only available if the device has the additional software for the diagnostics)
		X.CONTROL / Position controller active (symbol is indicated for Type 8793 only)
		CUTOFF active
		SAFEPOS active
		Interface I/O Burst
		Interface I/O RS232 HART
		SECURITY active
Other symbols for Type 8793		P.CONTROL / process controller active
		Bus active
		SIMULATION active

Table 22: Symbols of the process level

13.1.2 Flashing of the display background lighting

Flashing is used to localize the device in a network. It is activated when selecting the device in the Bürkert Communicator or when requested via a fieldbus.



13.2 Function of the keys

The function of the 4 keys for operation differs depending on the operating state (AUTOMATIC or MANU) and operating level (process level or setting level).

The key function which is active is displayed in the gray text field which is above the key.



The description of the operating levels and operating states can be found in chapter [“13 Operation”](#) and [“13.5 Operating states”](#).

Key function on the process level:			
Key	Key function	Description of the function	Operating state
Arrow key ▲	OPN	Manual opening of the actuator.	MANUAL
		Change the displayed value (e.g. <i>POS-CMD-TEMP-...</i>).	AUTOMATIC
Arrow key ▼	CLS	Manual closing of the actuator.	MANUAL
		Change the displayed value (e.g. <i>POS-CMD-TEMP-...</i>).	AUTOMATIC
left selection key 	MENU	Change to the setting level. Note: Press key for approx. 3 s.	AUTOMATIC or MANUAL
right selection key 	AUTO	Return to AUTOMATIC operating state.	MANUAL
	MANU	Change to MANUAL operating state.	AUTOMATIC



Key function on the setting level:		
Key	Key function	Description of the function
Arrow key ▲		Scroll up in the menus.
	+	Maximizing numerical values.
Arrow key ▼		Scroll down in the menus.
	-	Minimizing numerical values.
	<-	Change by one digit to the left; when entering numerical values.
left selection key 	EXIT	Return to the process level.
		Gradually return from a submenu option.
	ESC	Leave a menu.
	STOP	Stop a sequence.
right selection key 	ENTER	Select, activate or deactivate a menu option.
	SELEC	
	OK	
	INPUT	
	EXIT	Gradually return from a submenu option.
	RUN	Start a sequence.
	STOP	Stop a sequence.

Table 23: Function of the keys

13.2.1 Entering and changing numerical values

Changing numerical values with fixed decimal places:

Key	Key function	Description of the function	Example
Arrow key ▽		Change to the next decimal place (from right to left). After reaching the last decimal place, the display switches back to the first decimal place.	Enter date and time.
Arrow key △		Increase value. When the largest possible value has been reached, 0 is displayed again.	
left selection key 	 or 	Return without change.	
right selection key 		Accept the set value.	

Table 24: Change numerical values with fixed decimal places.

Enter numerical values with variable decimal places:

Key	Key function	Description of the function	Example
Arrow key △		Increase value.	Enter PWM signal
Arrow key ▽		Reduce value.	
left selection key 	 or 	Return without change.	
right selection key 		Accept the set value.	

Table 25: Enter numerical values with variable decimal places.

13.3 Adjusting the display

The display can be individually adjusted for the operation and monitoring of the process.

- To do this, menu options can be activated for displaying the process level. *POS* and *CMD* are activated in the as-delivered state.
- The menu options which can be displayed depend on the type.



How you can adjust the display for Type 8792 individually to the process to be controlled is described in chapter “16.1.20 EXTRAS – Setting the display” on page 117.

13.3.1 Possible displays of the process level

→ ▲ / ▼ select possible displays in AUTOMATIC operating state.

	<p>Actual position of the valve actuator (0 – 100%)</p>
	<ul style="list-style-type: none"> • Set-point position of the valve actuator or • Set-point position of the valve actuator after rescaling by possibly activated split range function or correction characteristic (0 – 100%)
	<p>Temperature (°C) of the electronics</p>
	<p>Process actual value Only for Type 8793</p>
	<p>Process set-point value <i>Right selection key</i> : <i>The key function depends on the set-point value default</i> <i>(menu: P.CONTROL → P.SETUP → SP-INPUT → internal/external).</i></p> <p>INPUT Set-point value default = internal MANU Set-point value default = external</p> <p>Only for Type 8793</p>
	<p>Graphical display of <i>SP</i> and <i>PV</i> with time axis Only for Type 8793</p>

	<p>Graphical display of <i>POS</i> and <i>CMD</i> with time axis</p>
	<p>Time, weekday and date</p>
	<p>Input signal for set-point position (0 – 5/10 V or 0/4 – 20 mA) Only for operation as position controller X.CO</p>
	<p>Automatic adjustment of the position controller</p>
	<p>Automatic optimization of the process controller parameters Only for Type 8793</p>
	<p>Automatic linearization of the process characteristics Only for Type 8793</p>
	<p>Simultaneous display of the set-point position and the actual position of the valve actuator (0 – 100%)</p>
	<p>Simultaneous display of the set-point position and the actual position of the valve actuator (0 – 100%) Only for Type 8793</p>

Table 26: Displays of the process level

MAN 1000341264 EN Version: F Status: RL (released | freigegeben) printed: 01.09.2023











13.4 Date and time

Date and time are set on the process level in the *CLOCK* menu.

To ensure that the menu for *CLOCK* can be selected on the process level, the following functions must be activated in 2 stages:

1. The *EXTRAS* auxiliary function in the *ADD.FUNCTION* menu
2. The *CLOCK* function in the *EXTRAS* auxiliary function, *DISP.ITEMS* submenu.

Activate *EXTRAS* and *CLOCK* as follows:

-  Press **MENU** for 3 s. Switching from process level ⇒ setting level.
- ▲ / ▼ Select *ADD.FUNCTION*.
-  Select **ENTER**. The possible auxiliary functions are displayed.
- ▲ / ▼ Select *EXTRAS*.
-  Select **ENTER**.
Activate the *EXTRAS* auxiliary function by marking with a cross ☒ and transfer into the main menu (MAIN).
-  Select **EXIT**. Return to the main menu (MAIN).
- ▲ / ▼ Select *EXTRAS*.
-  Select **ENTER**. The submenus of *EXTRAS* are displayed.
- ▲ / ▼ Select *DISP.ITEMS*.
-  Select **ENTER**. The possible menu options are displayed.
- ▲ / ▼ Select *CLOCK*.
-  Select **SELECT**. The activated *CLOCK* function is now marked by a cross ☒.
-  Select **EXIT**. Return to the *EXTRAS* menu.
-  Select **EXIT**. Return to the main menu (MAIN).
-  Select **EXIT**. Switching from setting level ⇒ process level.
- ✔ You have activated *EXTRAS* and *CLOCK*.



Date and time must be reset whenever the device is restarted.
After a restart the device therefore switches immediately and automatically to the corresponding menu.



13.4.1 Setting date and time

Activate the input screen as follows:

- On the process level select the display for *CLOCK* using the arrow keys Δ ∇ .
- Press **INPUT** to open the input screen for the setting.
- Set date and time as described in the following table.

✔ You have activated the input screen.

Set the date and time as follows:

- Select ∇ **<-**.
Switch to the next time unit (from right to left).
When the last time unit for the date has been reached, the display switches to the time units for the time.
If the last unit is at top left (hours), the display switches back to the first unit at bottom right (year).
 - Select Δ **+**.
Increase value.
When the largest possible value has been reached, 0 is displayed again.
 -  Select **ESC**. Return without change.
 -  Select **OK**. Accept the set value.
 - Δ / ∇ Select *EXTRAS*.
 -  Select **ENTER**. The submenus of *EXTRAS* are displayed.
 - Δ / ∇ Switching the display.
- ✔ You have set date and time.

13.5 Operating states

Type 8792/8793 has 2 operating states: AUTOMATIC and MANUAL.

When the operating voltage is switched on, the device is in the AUTOMATIC operating state.

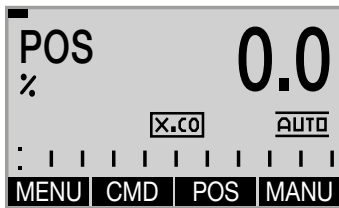

AUTOMATIC

In the AUTOMATIC operating state normal controlled operation is implemented.

(The symbol for AUTOMATIC **AUTO** is shown on the display. A bar runs along the upper edge of the display).

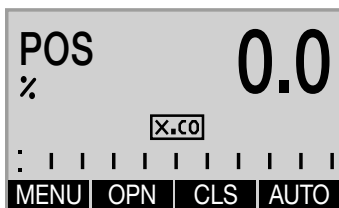

MANUAL

In the MANUAL operating state the valve can be manually opened or closed via the arrow keys Δ ∇ (key function **OPN** and **CLS**).

(The symbol for AUTOMATIC **AUTO** is hidden. No bar running along the upper edge of the display).

 The MANUAL operating state (key function **MANU**) is for the following process value displays only:
POS, CMD, PV, CMD/POS, SP/PV.
For SP only for external process set-point value.

13.5.1 Changing the operating state

Switch to the MANUAL operating state as follows:

→  Select **MANU**.

- ✓ You are in the MANUAL operating state.
Only available for process value display: POS, CMD, PV, SP

Switch to the AUTOMATIC operating state as follows:

→  Select **AUTO**.

- ✓ You are in the AUTO operating state.





13.6 Activating and deactivating auxiliary functions

Auxiliary functions can be activated for demanding control tasks.

 The auxiliary function is activated via the *ADD.FUNCTION* basic function and transferred to the main menu (MAIN).
The auxiliary functions can then be selected and set in the extended main menu (MAIN).

13.6.1 Activating auxiliary functions



Activate the auxiliary functions as follows:

-  Press **MENU** for 3 s. Switching from process level ⇒ setting level.
- ▲ / ▼ Select **ADD.FUNCTION**.
-  Select **ENTER**. The possible auxiliary functions are displayed.
- ▲ / ▼ Select *auxiliary function*.
-  Select **ENTER**. The selected auxiliary function is now marked by a cross ☒.
-  Select **EXIT**.
Acknowledgment and simultaneous return to the main menu (MAIN).
- ✔ You have activated the marked function and included it in the main menu.

Set the parameters as follows:

- ▲ / ▼ Select *auxiliary function*. In the main menu (MAIN) select the auxiliary function.
-  Select **ENTER**. Opening the submenu to input the parameters.
The setting of the submenu is described in the respective chapter of the auxiliary function.
- ✔ You have set the parameters.





Return from the submenu and switch the process level as follows:

-  Select **EXIT*** or **ESC***. Return to a higher level or to the main menu (MAIN).
-  Select **EXIT**. Switching from setting level ⇒ process level.
- ✔ You have changed the process level.

* The designation of the key depends on the selected auxiliary function.

13.6.2 Deactivating auxiliary functions

Deactivate the auxiliary functions as follows:

-  Press **MENU** for 3 s. Switching from process level ⇒ setting level.
- ▲ / ▼ Select **ADD.FUNCTION**.
-  Select **ENTER**. The possible auxiliary functions are displayed.
- ▲ / ▼ Select *auxiliary function*.
-  Select **ENTER**. Remove function mark (no cross ☐).
-  Select **EXIT**.
Acknowledgment and simultaneous return to the main menu (MAIN).
- ✔ You have deactivated the marked function and removed it from the main menu.



Deactivation removes the auxiliary function from the main menu (MAIN). This will cause the previous settings, created under this function, to be rendered invalid.

13.7 Manually opening and closing the valve

In the MANUAL operating state, the valve can be opened and closed manually using the arrow keys ▲ ▼.



The MANUAL operating state (key function **MANU**) is for the following process value displays:

- *POS*, actual position of the valve actuator.
- *CMD*, set-point position of the valve actuator.
When switching to MANUAL operating state *POS* is displayed.
- *PV*, process actual value.
- *SP*, process set-point value.
When switching to MANUAL operating state, *PV* is displayed. The switch is possible only for external set-point value default (menu: *P.CONTROL* → *P.SETUP* → *SP-INPUT* → *external*).
- *CMD/POS*, set-point position of the valve actuator.
When switching to MANUAL operating state *POS* is displayed.
- *SP/PV*, process set-point value.
When switching to MANUAL operating state, *PV* is displayed. The switch is possible only for external set-point value default (menu: *P.CONTROL* → *P.SETUP* → *SP-INPUT* → *external*).

Manually open and close as follows:

→ ▲ / ▼ Select *POS*, *CMD*, *PV* or *SP*.

→  Select **MANU**. Change to MANUAL operating state.

→ Select ▲. Aerating the actuator

Control function A (SFA):	Valve opens
Control function B (SFB):	Valve closes
Control function I (SFI):	Connection 2.1 aerated

→ Select ▼. Deaerating the actuator

Control function A (SFA):	Valve closes
Control function B (SFB):	Valve opens
Control function I (SFI):	Connection 2.2 aerated

✔ You have manually opened and closed the valve.



- SFA:** Actuator spring force closing
- SFB:** Actuator spring force opening
- SFI:** Double-acting actuator

14 START-UP



Before start-up, carry out fluid and electrical installation of Type 8792/8793 and of the valve. For description see chapter “11” and “12”.

When the operating voltage is applied, Type 8792/8793 is operating and is in the AUTOMATIC operating state. The display shows the process level with the values for *POS* and *CMD*.

The following basic settings must be made for starting up the device:

Device type	Sequence	Type of basic setting	Setting via	Description in chapter	Requirement
8792 and 8793	1	Basic setting of the device: Set input signal (standard signal).	<i>INPUT</i>	“14.2.1”	essential
	2	Adjust device to the local conditions.	<i>X.TUNE</i>	“14.2.2”	
only 8793 (Process controller)	3	Activate process controller.	<i>ADD.FUNCTION</i>	“14.3”	essential
	4	Basic setting of the process controller: – Setting the hardware – Parameter setting of the software.	<i>P.CONTROL</i> → <i>SETUP</i>	“15” “15.2”	
	5		→ <i>PID.PARAMETER</i>	“15.3”	
	6	Automatic linearization of the process characteristics.	<i>P.Q'LIN</i>	“15.4”	to be performed optionally
	7	Automatic parameter setting for the process controller.	<i>P.TUNE</i>	“15.5”	

Table 27: Start-up sequence

The basic settings are made on the setting level.

To switch from the process to the setting level, press the **MENU** key for approx. 3 seconds.

Then the main menu (MAIN) of the setting level is indicated on the display.

14.1 Safety instructions



WARNING

Risk of injury due to incorrect operation.

Improper operation may result in injuries as well as damage to the device and the area around it

- ▶ Before start-up, ensure that the operating personnel are familiar with and completely understand the contents of the operating instructions.
- ▶ Observe the safety instructions and intended use.
- ▶ Only adequately trained personnel may start up the equipment/the device.

14.2 Basic setting of the device







The following settings must be made for the basic setting of Type 8792/8793:

1. Selection of the input signal (see chapter "14.2.1").
2. Automatic self-parameterization of the position controller (see chapter "14.2.2")

14.2.1 INPUT - Setting the input signal

This setting is used to select the input signal for the set-point value.

Set the input signal as follows:

-  Press **MENU** for 3 s. Switching from process level ⇒ setting level.
-  Select **INPUT**.
-  Select **ENTER**. The possible input signals for **INPUT** are displayed.
-  Select input signal (*4 – 20 mA, 0 – 20 mA, ...*) Select.
-  Select **SELECT**. The selected input signal is now marked by a filled circle ●.
-  Select **EXIT**.
Return to the main menu (MAIN).
-  Select **EXIT**. Switching from setting level ⇒ process level.
- ✔ You have set the input signal.

14.2.2 X.TUNE – Automatic adjustment of the position controller

WARNING

Danger due to the valve position changing when the *X.TUNE* function is running.

When the *X.TUNE* function is run under operating pressure, there is an acute risk of injury.

- ▶ Never run *X.TUNE* while the process is running.
- ▶ Secure the device against accidental activation.

NOTE

An incorrect supply pressure or incorrectly connected operating medium pressure may cause the controller to be wrongly adjusted.

- ▶ Run *X.TUNE* in each case at the supply pressure available in subsequent operation (= pneumatic auxiliary power).
- ▶ Run the *X.TUNE* function preferably **without** operating medium pressure to exclude interference due to flow forces.

The following functions are actuated automatically:

- Adjustment of the sensor signal to the (physical) stroke of the actuator used.
- Determination of parameters of the PWM signals to control the solenoid valves integrated in Type 8792, 8793.
- Adjustment of the controller parameters for the position controller. Optimization occurs according to the criteria of the shortest possible transient time without overshoots.

Automatically adjust the position controller as follows:

→  Press **MENU** for 3 s. Switching from process level ⇒ setting level.

→  Select **X.TUNE**.

→  Select **RUN**. Hold down as long as countdown (5 ...) is running.

During the automatic adjustment messages are displayed indicating the progress of the **X.TUNE** (e.g. "TUNE #1...").

When the automatic adjustment ends, the message "X.TUNE READY" is indicated.

→ Select any key. Return to the main menu (MAIN).

→  Select **EXIT**. Switching from setting level ⇒ process level.

✓ You have automatically adjusted the position controller.



To stop **X.TUNE**, press the left or right selection key **STOP**.

Automatically determining dead band DBND by running X.TUNE:



When **X.TUNE** is running, the dead band can be automatically determined depending on the friction behavior of the actuating drive.

Before running **X.TUNE**, the **X.CONTROL** auxiliary function must be activated by incorporating it into the main menu (MAIN).

If **X.CONTROL** is not activated, a fixed dead band of 1% is used.



The changed data is saved in the memory (EEPROM) only when there is a switch to the process level, by leaving the main menu (MAIN) using the left selection key **EXIT**.

Possible error messages when running *X.TUNE*:

Display	Causes of error	Remedy
<i>TUNE</i> <i>err/break</i>	Manual termination of self-optimization by pressing the EXIT key.	
<i>X.TUNE</i> <i>locked</i>	The <i>X.TUNE</i> function is blocked.	Enter access code.
<i>X.TUNE</i> <i>ERROR 1</i>	No compressed air connected.	Connect compressed air.
<i>X.TUNE</i> <i>ERROR 2</i>	Compressed air failure while Autotune (<i>X.TUNE</i>) is running.	Check compressed air supply.
<i>X.TUNE</i> <i>ERROR 3</i>	Actuator or control system deaeration side leaking.	Not possible, device defective.
<i>X.TUNE</i> <i>ERROR 4</i>	Control system aeration side leaking.	Not possible, device defective.
<i>X.TUNE</i> <i>ERROR 5</i>	The rotation range of the position sensor has exceeded 180°.	Correct attachment of the position sensor shaft to the actuator (see <i>chapter</i> “ 11.2 ” and “ 11.3 ”).
<i>X.TUNE</i> <i>ERROR 6</i>	The end positions for <i>POS-MIN</i> and <i>POS-MAX</i> are too close together.	Check compressed air supply.
<i>X.TUNE</i> <i>ERROR 7</i>	Incorrect assignment <i>POS-MIN</i> and <i>POS-MAX</i> .	To determine <i>POS-MIN</i> and <i>POS-MAX</i> , move the actuator in the direction indicated on the display.
<i>X.TUNE</i> <i>WARNING 1*</i>	Potentiometer is not coupled optimally to the actuator. An optimum connection can provide a more accurate position measurement.	Set the center position as described in <i>chapter</i> “ 11.2.4 Aligning the lever mechanism ”.

* *Warning information gives tips for optimized operation. The device is operational even if this warning information is not observed. Warning information is automatically hidden after several seconds.*

Table 28: *X.TUNE*; possible error messages

After making the settings described in *chapter* “[14.2](#)”, the positioner (position controller) is ready for use. Activation and configuration of auxiliary functions is described in the following *chapter* “[16 Auxiliary functions](#)”.

14.2.3 *X.TUNE.CONFIG* – Manual configuration of *X.TUNE*

 This function is needed for special requirements only.

 For standard applications the *X.TUNE* function (automatic adjustment of the positioner), as described above, is run using the factory default settings.





The description of the *X.TUNE.CONFIG* function can be found in *Chapter* “[16.2 Manual configuration of X.TUNE](#)”

14.3 Activation of the process controller

The process controller is activated by selecting the *P.CONTROL* auxiliary function in the *ADD.FUNCTION* menu.

The activation transfers *P.CONTROL* into the main menu (MAIN) where it is available for further settings.

Activate the process controller as follows:

-  Press **MENU** for 3 s. Switching from process level ⇒ setting level.
- ▲ / ▼ Select *ADD.FUNCTION*.
-  Select **ENTER**. The possible auxiliary functions are displayed.
- ▲ / ▼ Select *P.CONTROL*.
-  Select **ENTER**. *P.CONTROL* is now marked by a cross ☒.
-  Select **EXIT**. Acknowledgment and simultaneous return to the main menu (MAIN).
P.CONTROL is now activated and incorporated into the main menu.
- ✔ You have activated the process controller.



Following activation of *P.CONTROL*, the *P.Q'LIN* and *P.TUNE* menus are also available in the main menu (MAIN). They offer support for the setting of the process control.

P.Q'LIN Linearization of the process characteristic
Description see chapter [“15.4”](#)

P.TUNE Self-optimization of the process controller (process tune)
Description see chapter [“15.5”](#)

ADD.FUNCTION – Add auxiliary functions





Apart from activating the process controller, *ADD.FUNCTION* can be used to activate auxiliary functions and incorporate them into the main menu.

The description can be found in chapter [“16 Auxiliary functions”](#).







15 BASIC SETTING OF THE PROCESS CONTROLLER

15.1 *P.CONTROL* – Setting up and parameterization of the process controller

Set up the process controller as follows:

-  Press **MENU** for 3 s. Switching from process level ⇒ setting level.
- ▲ / ▼ Select *P.CONTROL*. Selection in the main menu (MAIN).
-  Select **ENTER**. The submenu options for the basic setting are displayed.
- ▲ / ▼ Select *SETUP*.
-  Select **ENTER**. The menu for setting up the process controller is displayed. Setting up is described in chapter [“15.2 SETUP – Setting up the process controller”](#).
-  Select **EXIT**. Return to *P.CONTROL*.
- ✔ You have set up the process controller.

Parameterize the process controller as follows:

-  Press **MENU** for 3 s. Switching from process level ⇒ setting level.
- ▲ / ▼ Select *P.CONTROL*. Selection in the main menu (MAIN).
-  Select **ENTER**. The submenu options for the basic setting are displayed.
- ▲ / ▼ Select *PID.PARAMETER*.
-  Select **ENTER**. The menu for parameterizing the process controller is displayed. Parameterization is described in chapter [“15.3 PID.PARAMETER – Parameterizing the process controller”](#).
-  Select **EXIT**. Return to *P.CONTROL*.
-  Select **EXIT**. Return to the main menu (MAIN).
-  Select **EXIT**. Switching from setting level ⇒ process level.
- ✔ You have parameterized the process controller.

15.2 SETUP – Setting up the process controller

These functions specify the type of control.

The procedure is described in the following chapters “15.2.1” to “15.2.5”.

15.2.1 PV-INPUT – Specifying signal type for the process actual value

One of the following signal types can be selected for the process actual value:

- | | | |
|-----------------------|---------------|---|
| • Standard signal | 4 – 20 mA | flow rate, pressure, level, temperature |
| • Frequency signal | 0 – 1000 Hz | flow rate |
| • Circuit with Pt 100 | -20 – +220 °C | temperature |
| • Bus * | | flow rate, pressure, level, temperature |

Factory setting: 4 – 20 mA

Specify the signal type *PV-INPUT* in the *SETUP* menu:

→ ▲ / ▼ Select *PV-INPUT*.

→  Select **ENTER**. The signal types are displayed.

→ ▲ / ▼ Select signal type.

→  Select **SELECT**. The selected signal type is now marked by a filled circle ●.

→  Select **EXIT**. Return to *SETUP*.

✔ You have specified the signal type.

* Only for devices with bus interface

15.2.2 PV-SCALE– Scaling of the process actual value

The following settings are specified in the submenu of *PV-SCALE*:

- | | |
|--------------|---|
| <i>PVmin</i> | 1. The physical unit of the process actual value. |
| | 2. Position of the decimal point of the process actual value. |
| | 3. Lower scaling value of the process actual value. |

 In *PVmin* the unit of the process actual value and the position of the decimal point are specified for all scaling values (*SPmin*, *SPmax*, *PVmin*, *PVmax*).

- | | |
|--------------|--|
| <i>PVmax</i> | Upper scaling value of the process actual value. |
|--------------|--|

- | | |
|-----------------|---|
| <i>K factor</i> | K factor for the flow sensor
The menu option is available only for the frequency signal type (<i>PV-INPUT</i> → <i>Frequency</i>). |
|-----------------|---|

15.2.2.1. Effects and dependencies of the settings of PV-INPUT on PV-SCALE

The settings in the PV-SCALE menu have different effects, depending on the signal type selected in PV-INPUT.



Even the selection options for the units of the process actual value (in PVmin) depend on the signal type selected in PV-INPUT.

See following "Table 29"

Settings in the submenu of PV-SCALE	Description of the effect	Dependency on the signal type selected in PV-INPUT			
		4 - 20 mA	PT 100	Frequency	Bus
PVmin	Selectable unit of the process actual value for the physical variables.	Flow rate, temperature, pressure, length, volume. (as well as ratio as% and no unit)	Temperature	Flow rate	Flow rate, temperature, pressure, length, volume. (as well as ratio as% and no unit)
	Adjustment range:	0 – 9999 (temperature -200 – 800)	-200 – 800	0 – 9999	0 – 9999 (temperature -200 – 800)
PVmin PVmax	Specification of the reference range for the dead band of the process controller (P.CONTROL → PID. PARAMETER → DBND).	Yes	Yes	Yes	Yes
	Specification of the reference range for the analog feedback (option). See chapter "16.1.16 OUTPUT – Configuration of the outputs (option)".	Yes	Yes	Yes	Yes
	Sensor calibration:	Yes see "Figure 30"	No	No	Yes see "Figure 30"
K factor	Sensor calibration:	No	No	Yes see "Figure 31"	No
	Adjustment range:	–	–	0 – 9999	–

Table 29: Effects of the settings in PV-SCALE depending on the signal type selected in PV-INPUT

Example of a sensor calibration for the 4 - 20 mA signal type:

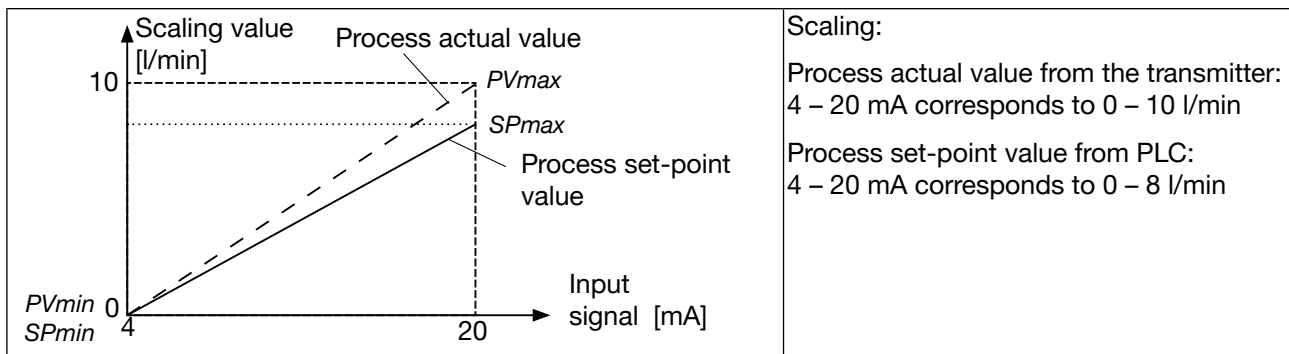

Figure 30: Example of a sensor calibration for the 4 - 20 mA signal type

! For internal set-point value default (*SP-INPUT* → *internal*), the process set-point value is input directly on the process level.

Example of a sensor calibration for frequency signal type:

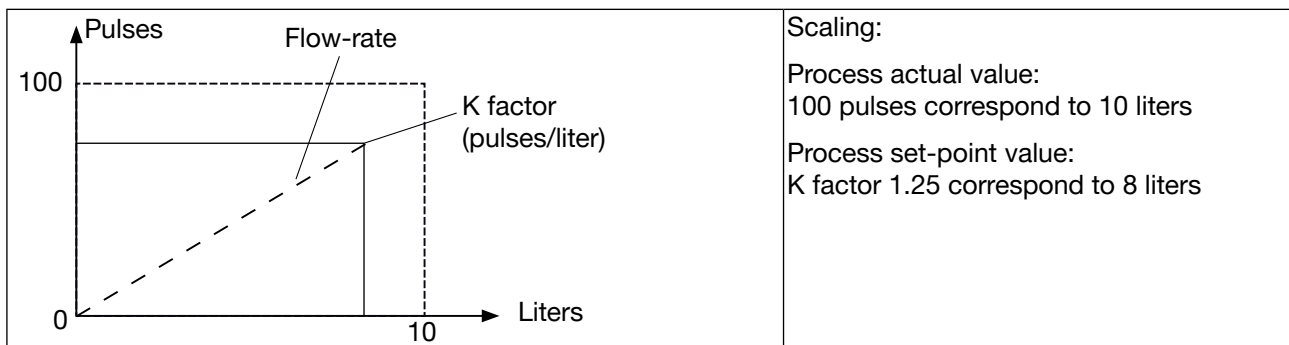

Figure 31: Example of a sensor calibration for frequency signal type

Scale the process actual value in the menu as follows:

- ▲ / ▼ Select **PV-SCALE**. Selection in the main menu (MAIN).
- Select **ENTER**. The submenu options for scaling of the process actual value are displayed.
- ✔ You have scaled the process actual value.

PVmin is set as follows:

- ▲ / ▼ Select **PVmin**.
- Select **INPUT**. The input screen is opened.
First specify the physical unit which has a dark background.
- ▲ Select **+**. Select physical unit.
- ▼ Select **<-** decimal point. The decimal point has a dark background.
- ▲ Select **+**. The last digit of the scaling value has a dark background.
- ▼ Select **<-** scaling value. The last digit of the scaling value has a dark background.

→ ▲ / ▼ **+** Increase value and **<-** select decimal place.
Set scaling value (lower process actual value).

→  Select **OK**. Return to *PV-SCALE*.

✔ You have set the PVmin.

PVmax is set as follows:

→ ▲ / ▼ Select PVmax.

→  Select **INPUT**. The input screen is opened.
The last digit of the scaling value has a dark background.

→ ▲ / ▼ **+** Increase value and **<-** select decimal place.
Set scaling value (lower process actual value).

→  Select **OK**. Return to *PV-SCALE*.

✔ You have set the PVmax.

Set the K factor as follows:

→ ▲ / ▼ Select *K factor*.

→  Select **ENTER**. The submenu options for scaling of the process actual value are displayed.

Either:

→ ▲ / ▼ Select **VALUE**. Manual input of the K factor.

→  Select **INPUT**. The input screen is opened. The decimal point has a dark background.

→ ▲ Select **+**. Specify position of the decimal point.

→ ▼ Select **<-** the value. The last digit of the value has a dark background.

→ ▲ / ▼ **+** Increase value and **<-** select decimal place.
Set K factor.

→  Select **OK**. Return to *K factor*.

Or:

→ ▲ / ▼ Select **TEACH-IN**. Calculating the K factor by measuring a specific flow rate.

→  Select **INPUT**. The input screen is opened. The decimal point has a dark background.

→  Select **ENTER**, hold down for 5 s. Valve closes.

→  Select **START**. The container is being filled.

→  Select **STOP**. The measured volume is displayed and the input screen is opened.
The decimal point has a dark background.

→ ▲ **+** Select decimal point. Specify position of the decimal point.

→ ▼ **<-** Select the value. The last digit of the value has a dark background.

→ ▲ Select **+**. The last digit of the scaling value has a dark background.

→ ▲ / ▼ + Increase value and <- select decimal place.
Set the measured volume.

→  Select **OK**. Return to *TEACH-IN*.

→  Select **EXIT**. Return to *K factor*.

→  Select **EXIT**. Return to *PV-SCALE*.

→  Select **EXIT**. Return to *SETUP*.

✔ You have set the K factor.





If the submenu is left by pressing the left selection key **ESC**, the value remains unchanged.

15.2.3 SP-INPUT – Type of set-point value default (internal or external)

The SP-INPUT menu specifies how the default of the process set-point value is to be implemented.

- Internal: Input of the set-point value on the process level
- External: Default of the set-point value via the standard signal input

Set the type of set-point value default as follows:

- ▲ / ▼ Select **SP-INPUT**
-  Select **ENTER**. The types of set-point value default are displayed.
- ▲ / ▼ Select the type of set-point value default.
-  Select **SELECT**. The selection is marked by a filled circle ●.
-  Select **EXIT**. Return to **SETUP**.

✔ You have set the type of set-point value default.



For internal set-point value default (*SP-INPUT* → *internal*), the process set-point value is input directly on the process level.

15.2.4 SP-SCALE – Scaling of the process set-point value (for external set-point value default only)

The *SP-SCALE* menu assigns the values for the lower and upper process set-point value to the particular current or voltage value of the standard signal.





The menu is available for external set-point value default only (*SP-INPUT* → *external*).





For internal set-point value default (*SP-INPUT* → *internal*), there is no scaling of the process set-point value via *SPmin* and *SPmax*.

The set-point value is entered directly on the process level. The physical unit and the position of the decimal point are specified during the scaling of the process actual value (*PV-SCALE* → *PVmin*). For a description see chapter “15.2.2 *PV-SCALE*– Scaling of the process actual value” on page 71

Scale the process set-point value as follows:

- ▲ / ▼ Select **SP-SCALE**
-  Select **ENTER**. The submenu options for scaling of the process set-point value are displayed.
- ▲ / ▼ Select **SPmin**.
-  Select **INPUT**. The input screen is opened.
- ▲ / ▼ **+** Increase value and **<-** select decimal place.
Set scaling value (lower process set-point value). The value is assigned to the smallest current or voltage value of the standard signal.
-  Select **OK**. Return to **SP-SCALE**.
- ▲ / ▼ Select **SPmax**.
-  Select **INPUT**. The input screen is opened.

- ▲ / ▼ **+** Increase value and **<-** select decimal place.
Set scaling value (upper process set-point value). The value is assigned to the largest current or voltage value of the standard signal.
-  Select **OK**. Return to *SP-SCALE*.
-  Select **EXIT**. Return to *SETUP*.
- ✔ You have scaled the process set-point value.



 If the submenu is left by pressing the left selection key **ESC**, the value remains unchanged.

15.2.5 P.CO-INIT – Smooth switchover MANUAL-AUTOMATIC

The smooth switchover between the MANUAL and AUTOMATIC operating states can be activated or deactivated in the *P.CO-INIT* menu.

Factory default setting: *bumpless* Smooth switchover activated.

Activate the smooth switchover of the operating states as follows:

- ▲ / ▼ Select *P.CO-INIT*
-  Select **ENTER**. The function (*bumpless*) and (*standard*) is displayed.
- ▲ / ▼ Select required function.
bumpless = smooth switchover activated
standard = smooth switchover deactivated
-  Select **SELECT**. The selection is marked by a filled circle ●.
-  Select **EXIT**. Return to *SETUP*.
- ✔ You have switched over the operating states.

15.3 PID.PARAMETER – Parameterizing the process controller

The following control parameters of the process controller are manually set in this menu.

DBND 1.0%	Insensitivity range (dead band) of the process controller
KP 1.00	Amplification factor of the (P portion of the PID controller)
TN 999.0	Reset time (I portion of the PID controller)
TV 0.0	Hold-back time (D portion of the PID controller)
X0 0.0%	Operating point
FILTER 0	Filtering of the process actual value input



The automatic parameterization of the PID controller integrated in the process controller (menu options *KP*, *TN*, *TV*) can be implemented with the aid of the *P.TUNE* function (see chapter “15.5 *P.TUNE* – Self-optimization of the process controller”).



Basic information for setting the process controller can be found in chapters “27.2 Properties of PID controllers” and “27.3 Adjustment rules for PID controllers”

15.3.1 DBND – Insensitivity range (dead band)

This function causes the process controller to respond from a specific control difference only. This protects both the solenoid valves in Type 8792, 8793 and the pneumatic actuator.

Factory setting: 1.0% with reference to the range of the scaled process actual value (setting in the menu *PV-SCALE* → *PVmin* → *PVmax*).

Enter the parameters as follows:

→ ▲ / ▼ Select *PID.PARAMETER*.

→  Select **ENTER**. The menu for parameterizing the process controller is displayed.

→ ▲ / ▼ Select *menu option*.

→  Select **INPUT**. The input screen is opened.

→ ▲ / ▼ **+** Increase value and **-** reduce value
Set value at

* / /

→  Select **OK**. Return to *PID.PARAMETER*.

→  Select **EXIT**. Return to *P.CONTROL*.

→  Select **EXIT**. Return to the main menu (MAIN).

→  Select **EXIT**. Return to *P.CONTROL*. Switching from setting level ⇔ process level.

✔ You have set the parameter.



If the submenu is left by pressing the left selection key **ESC**, the value remains unchanged.

Insensitivity range for process control

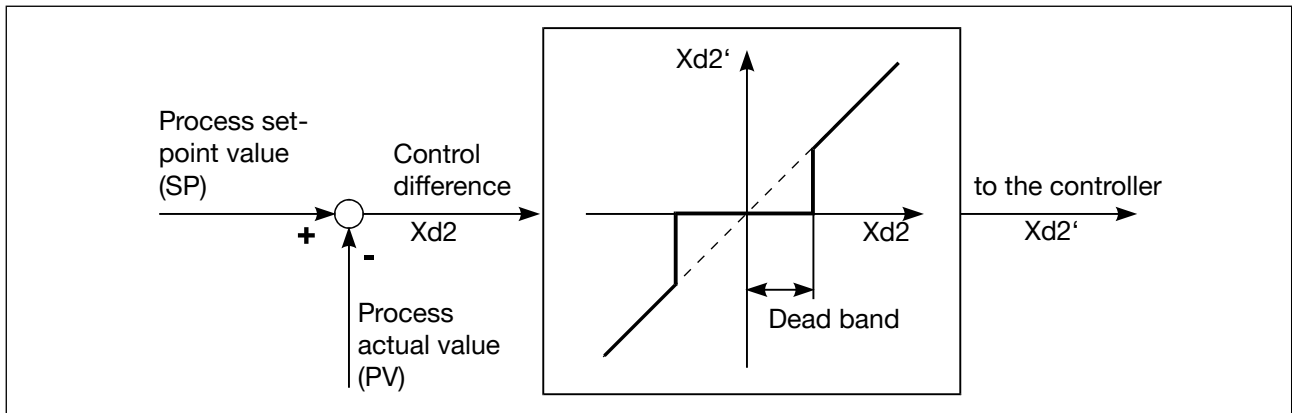

Figure 32: DBND graph; insensitivity range for process control

15.3.2 KP – Amplification factor of the process controller

The amplification factor specifies the P portion of the PID controller (can be set with the aid of the *P.TUNE* function).

Factory setting: 1.00

Enter the parameters as follows:

- ▲ / ▼ Select *PID.PARAMETER*.
- Select **ENTER**. The menu for parameterizing the process controller is displayed.
- ▲ / ▼ Select *menu option*.
- Select **INPUT**. The input screen is opened.
- ▲ / ▼ **<-** Select decimal place and **+** increase value
Set value at
- *

<i>KP</i>	X.XX	/	<i>TN</i>	X.0 sec	/	<i>TV</i>	1.0 sec
-----------	------	---	-----------	---------	---	-----------	---------
- Select **OK**. Return to *PID.PARAMETER*.
- Select **EXIT**. Return to *P.CONTROL*.
- Select **EXIT**. Return to the main menu (MAIN).
- Select **EXIT**. Return to *P.CONTROL*. Switching from setting level ⇌ process level.
- ✔ You have set the parameter.

If the submenu is left by pressing the left selection key **ESC**, the value remains unchanged.

The *KP* amplification of the process controller refers to the scaled, physical unit.

15.3.3 TN – Reset time of the process controller

The reset time specifies the I portion of the PID controller, can be set with the *P.TUNE* function.

Factory setting: 999.9 s



Enter the parameters as follows:

→ ▲ / ▼ Select *PID.PARAMETER*.

→  Select **ENTER**. The menu for parameterizing the process controller is displayed.

→ ▲ / ▼ Select *menu option*.

→  Select **INPUT**. The input screen is opened.

→ ▲ / ▼  Select decimal place and  increase value

Set value at

<i>TN</i>	999.9
-----------	-------

→  Select **OK**. Return to *PID.PARAMETER*.

→  Select **EXIT**. Return to *P.CONTROL*.

→  Select **EXIT**. Return to the main menu (MAIN).

→  Select **EXIT**. Return to *P.CONTROL*. Switching from setting level ⇔ process level.

 You have set the parameter.



If the submenu is left by pressing the left selection key **ESC**, the value remains unchanged.

15.3.4 TV – Hold-back time of the process controller

The hold-back time specifies the D portion of the PID controller (can be set with the aid of the *P.TUNE* function).

Factory setting: 0.0 s



Enter the parameters as follows:

→ ▲ / ▼ Select *PID.PARAMETER*.

→  Select **ENTER**. The menu for parameterizing the process controller is displayed.

→ ▲ / ▼ Select *menu option*.

→  Select **INPUT**. The input screen is opened.

→ ▲ / ▼  Select decimal place and  increase value

Set value at

<i>TV</i>	0.0
-----------	-----

→  Select **OK**. Return to *PID.PARAMETER*.

→  Select **EXIT**. Return to *P.CONTROL*.

→  Select **EXIT**. Return to the main menu (MAIN).

→  Select **EXIT**. Return to *P.CONTROL*. Switching from setting level ⇔ process level.

 You have set the parameter.



If the submenu is left by pressing the left selection key **ESC** , the value remains unchanged.

15.3.5 X0 – Operating point of the process controller

The operating point corresponds to the operating point of the proportional portion when control difference = 0.

Factory setting: 0.0%

Enter the parameters as follows:

→ ▲ / ▼ Select *PID.PARAMETER*.

→  Select **ENTER**. The menu for parameterizing the process controller is displayed.

→ ▲ / ▼ Select *menu option*.

→  Select **INPUT**. The input screen is opened.

→ ▲ / ▼ **+** Increase value and **-** reduce value

Set value at

→  Select **OK** . Return to *PID.PARAMETER*.

→  Select **EXIT**. Return to *P.CONTROL*.

→  Select **EXIT**. Return to the main menu (MAIN).

→  Select **EXIT**. Return to *P.CONTROL*. Switching from setting level ⇔ process level.

✓ You have set the parameter.



If the submenu is left by pressing the left selection key **ESC** , the value remains unchanged.

15.3.6 FILTER – Filtering of the process actual value input

The filter is valid for all process actual value types and has a low-pass behavior (PT1).

Factory setting: 0

Enter the parameters as follows:

→ ▲ / ▼ Select *PID.PARAMETER*.

→  Select **ENTER**. The menu for parameterizing the process controller is displayed.

→ ▲ / ▼ Select *menu option*.



→  Select **INPUT**. The input screen is opened.

→ ▲ / ▼ **+** Increase value and **-** reduce value

Set value at

→  Select **OK** . Return to *PID.PARAMETER*.

→  Select **EXIT**. Return to *P.CONTROL*.

-  Select **EXIT**. Return to the main menu (MAIN).
-  Select **EXIT**. Return to *P.CONTROL*. Switching from setting level ⇔ process level.
- ✓ You have set the parameter.

 If the submenu is left by pressing the left selection key **ESC**, the value remains unchanged.

Setting the filter effect in 10 stages

Setting	Corresponds to limit frequency (Hz)	Effect
0	10	Lowest filter effect
1	5	
2	2	
3	1	
4	0.5	
5	0.2	
6	0.1	
7	0.07	
8	0.05	
9	0.03	

Table 30: Setting the filter effect

 On Page 208 you will find a table for entering your set parameters.

15.4 P.Q'LIN – Linearization of the process characteristic



This function automatically linearizes the process characteristic.

In doing so, the nodes for the correction characteristic are automatically determined. To do this, the program moves through the valve stroke in 20 steps and measures the associated process variable.

The correction characteristic and the associated value pairs are saved in the menu option *CHARACT* → *FREE*. This is where they can be viewed and freely programmed. For a description see chapter “16.1.3”.

If the *CARACT* menu option has still not been activated and incorporated into the main menu (MAIN), this will happen automatically when *P.Q'LIN* is being run.

Run the *P.Q'LIN* as follows:

-  Select *P.Q'LIN*. The function is in the main menu (MAIN) after activation of *P.CONTROL*.
-  Select **RUN**. Hold down as long as countdown (5 ...) is running. *P.Q'LIN* is started.

The following displays are indicated on the display:

Q'LIN #0
CMD=0%

Q.LIN #1
CMD=10%

... continuing to

Q.LIN #10
CMD=100%

Display of the node which is currently running (progress is indicated by a progress bar along the upper edge of the display).

Q.LIN
ready

Automatic linearization was successfully completed.

→ Select **EXIT**. Return to the main menu (MAIN).

✔ You have set the parameter.

Possible error messages when running P.Q'LIN:

Display	Cause of error	Remedy
Q.LIN err/break	Manual termination of linearization by pressing the EXIT key.	
P.Q'LIN ERROR 1	No supply pressure connected.	Connect supply pressure.
	No change to process variable.	Check process and, if required, switch on pump or open the shut-off valve. Check process sensor.
P.Q'LIN ERROR 2	Failure of the supply pressure while P.Q'LIN running.	Check supply pressure.
	Automatic adjustment of the X.TUNE position controller not run.	Run X.TUNE.

Table 31: P.Q'LIN; possible error messages

15.5 P.TUNE – Self-optimization of the process controller

This function can be used to automatically parameterize the PID controller integrated in the process controller.

In doing so, the parameters for the P, I and D portion of the PID controller are automatically determined and transferred to the corresponding menus of (KP, TN, TV). This is where they can be viewed and changed.

Explanation of the PID controller:

The control system of Type 8793 has an integrated PID process controller. Any process variable, such as flow rate, temperature, pressure, etc., can be controlled by connecting an appropriate sensor.

To obtain good control behavior, the structure and parameterization of the PID controller must be adjusted to the properties of the process (controlled system).

This task requires control experience as well as measuring instruments and is time-consuming. The P.TUNE function can be used to automatically parameterize the PID controller integrated in the process controller.



Basic information for setting the process controller can be found in chapters [“27.2 Properties of PID controllers”](#) and [“27.3 Adjustment rules for PID controllers”](#)

MAN 1000341264 EN Version: F Status: RL (released | freigegeben) printed: 01.09.2023

15.5.1 The operating mode of *P.TUNE*

The *P.TUNE* function automatically identifies the process. To do this, the process is activated with a defined disturbance variable. Typical process characteristics are derived from the response signal and the structure and parameters of the process controller are determined on the basis of the process characteristics.

When using *P.TUNE* self-optimization, optimum results are obtained under the following conditions:

- Stable or stationary conditions concerning the process actual value *PV* when starting *P.TUNE*.
- Execution of *P.TUNE* in the operating point or within the operating range of the process control.

15.5.2 Preparatory measures for execution of *P.TUNE*



The measures described below are not compulsory conditions for running the *P.TUNE* function. However, they will increase the quality of the result.

The *P.TUNE* function can be run in the MANUAL or AUTOMATIC operating state.

When *P.TUNE* is complete, the control system is in the operating state which was set previously.

15.5.2.1. Preparatory measure for execution of *P.TUNE* in the MANUAL operating state

Move the process actual value up to the operating point as follows:

- ▲ / ▼ Select *PV*. The process actual value *PV* is indicated on the display.
-  Select **MANU**. Change to MANUAL operating state.
The input screen for manually opening and closing the valve is displayed.
- ▲ Open valve **OPN** or ▼ close valve **CLS**
By opening or closing the control valve, move the process actual value to the required operating point.
- As soon as the process actual value *PV* is constant, the *P.TUNE* function can be started.
- ✔ You have moved the process actual value *PV* to the operating point.

15.5.2.2. Preparatory measure for execution of *P.TUNE* in the AUTOMATIC operating state

By inputting a process set-point value *SP*, move the process actual value *PV* to the operating point.



Observe the internal or external set-point value default for the input (*P,CONTROL* → *SETUP* → *SP-INPUT* → *internal/external*):



For internal set-point value default: Input the process set-point value *SP* via the device keyboard (see description below).

For external set-point value default: Input the process set-point value *SP* via the analog set-point value input.

Enter the process set-point value as follows: (**Setting on the process level**)

→ ▲ / ▼ Select **SP**. The process set-point value is indicated on the display.

→  Select **INPUT**. The input screen for inputting the process set-point value is displayed.

→ ▲ / ▼ Enter value  Select decimal place
 Increase value

The selected set-point value *SP* should be near the future operating point.

→  Select **OK**. Acknowledge input and return to the display of *SP*.

✔ You have entered the process actual value.

The process variable *PV* is changed according to the set-point value default based on the factory default PID parameters.

→ Before running the *P.TUNE* function, wait until the process actual value *PV* has reached a stable state.



To observe *PV*, it is recommended to select via the arrow keys ▲ / ▼ the graphical display *SP/PV(t)*.

To be able to select the display *SP/PV(t)* it must be activated in the EXTRAS menu (see chapter "16.1.20 EXTRAS – Setting the display").

→ If *PV* oscillates continuously, the preset amplification factor of the process controller *KP* in the menu *P.CONTROL* → *PID.PARAMETER* should be reduced.

→ As soon as the process actual value *PV* is constant, the *P.TUNE* function can be started.

15.5.3 Starting the function *P.TUNE*



WARNING

Risk of injury from uncontrolled process.

While the *P.TUNE* function is running, the control valve automatically changes the current degree of opening and intervenes in the running process.

- ▶ Using suitable measures, prevent the permitted process limits from being exceeded.
 For example by:
 - an automatic emergency shutdown
 - stopping the *P.TUNE* function by pressing the STOP key (press left or right key).

Set the *P.TUNE* function as follows:

→  Press **MENU** for 3 s. Switching from process level ⇒ setting level.

→ ▲ / ▼ Select *P.TUNE*.

→  Select **RUN**. Hold down as long as countdown (5 ...) is running.

During the automatic adjustment the following messages are indicated on the display.

"starting process tune" - Start self-optimization.

"identifying control process" - Process identification. Typical process variables are determined from the response signal to a defined stimulus.

"calculating PID parameters" - Structure and parameters of the process controller are determined.

"TUNE ready" - Self-optimization was successfully completed.

→ Press any key. Return to the main menu (MAIN).

→  Select **EXIT**. Switching from setting level ⇒ process level.

✔ You have set the P.TUNE function.

! To stop *P.TUNE*, press the left or right selection key **STOP**.

! The changed data is saved in the memory (EEPROM) only when there is a switch to the process level, by leaving the main menu (MAIN) using the left selection key **EXIT**.

Possible error messages when running *P.TUNE*:

Display	Cause of error	Remedy
<i>TUNE</i> <i>err/break</i>	Manual termination of self-optimization by pressing the EXIT key.	
<i>P.TUNE</i> <i>ERROR 1</i>	No supply pressure connected.	Connect supply pressure.
	No change to process variable.	Check process and, if required, switch on pump or open the shut-off valve. Check process sensor.

Table 32: *P.TUNE*; possible error messages

After making all the settings described in chapter “[Start-up](#)”, the process controller is ready for operation.

Activation and configuration of auxiliary functions is described in the following chapter “[16 Auxiliary functions](#)”.

16 AUXILIARY FUNCTIONS

The device has auxiliary functions for demanding control tasks.

This chapter describes how the auxiliary functions are activated, set and configured.

Overview and description of the auxiliary functions:

ADD.FUNCTION	Description
CHARACT	Selection of the transfer characteristic between input signal and stroke (correction characteristic)
CUTOFF	Sealing function for position controller
DIR.CMD	Effective direction between input signal and set-point position
DIR.ACT	Assignment of the aeration state of the actuator chamber to the actual position
SPLTRNG *	Signal split range; input signal as a% for which the valve runs through the entire stroke range.
X.LIMIT	Limit of the mechanical stroke range
X.TIME	Limit of the control speed
X.CONTROL	Parameterization of the position controller
P.CONTROL	Parameterization of the process controller
SECURITY	Code protection for settings
SAFEPOS	Input the safety position
SIG.ERROR	Configuration of signal level fault detection
BINARY.IN	Activation of the digital input
OUTPUT	Configuration of outputs (option)
CAL.USER	Calibration
SET.FACTORY	Reset to factory settings
SERVICE.BUES	Configuring the büS service interface
EXTRAS	Setting the display
POS.Sensor	Setting interface remote position sensor (available for Type 8793 Remote only)
SERVICE	For internal use only
SIMULATION	Simulation of set-point value, process valve, process
DIAGNOSE	Diagnostic menu (option)

* The SPLTRNG auxiliary function can only be selected if P.CONTROL (process control) is not activated.

Figure 33: Overview - auxiliary functions





16.1 Activating and deactivating auxiliary functions

The required auxiliary functions must be activated by the user initially by incorporation into the main menu (MAIN). The parameters for the auxiliary functions can then be set.



To deactivate a function, remove it from the main menu. This will cause the previous settings, created under this function, to be rendered invalid again.

16.1.1 Including auxiliary functions in the main menu

Add auxiliary functions to ADD.FUNCTION as follows:

-  Press **MENU** for 3 s. Switching from process level ⇒ setting level.
- ▲ / ▼ Select **ADD.FUNCTION**.
-  Select **ENTER**. The possible auxiliary functions are displayed.
- ▲ / ▼ Select required auxiliary function
-  Select **ENTER**. The selected auxiliary function is now marked by a cross ☒.
-  Select **EXIT**. Acknowledgment and simultaneous return to the main menu (MAIN).
The marked function is now activated and incorporated into the main menu.
- ✔ You have added the auxiliary functions.

Set the parameters of the auxiliary functions as follows:

- ▲ / ▼ Select auxiliary function. In the main menu (MAIN) select the auxiliary function.
-  Select **ENTER**. Opening the submenu to input the parameters.
For information on the settings, see the descriptions of the auxiliary functions.
-  Select **EXIT** * or **ESC** *. Return to a higher level or to the main level (MAIN).
-  Select **EXIT**. Switching from setting level ⇒ process level.
- ✔ You have parameterized the auxiliary functions.

* The designation of the key depends on the selected auxiliary function.







The changed data is saved in the memory (EEPROM) only when there is a switch to the process level, by leaving the main menu (MAIN) using the left selection key **EXIT**.

16.1.2 Removing auxiliary functions from the main menu



If a function is removed from the main menu, the settings implemented previously under this function become invalid again.

Remove auxiliary functions from **ADD.FUNCTION** as follows:

-  Press **MENU** for 3 s. Switching from process level ⇒ setting level.
- ▲ / ▼ Select **ADD.FUNCTION**.
-  Select **ENTER**. The possible auxiliary functions are displayed.
- ▲ / ▼ Select auxiliary function
-  Select **ENTER**. Remove function mark (no cross).
-  Select **ENTER**. Acknowledgment and simultaneous return to the main menu (MAIN).
The marked function is now deactivated and removed from the main menu.

✔ You have removed the auxiliary functions.

16.1.3 CHARACT – Selection of the transfer characteristic between input signal (set-point position) and stroke

Characteristic (customer-specific characteristic)





Use this auxiliary function to select a transfer characteristic with reference to set-point value (set-point position, *CMD*) and valve stroke (*POS*) for correction of the flow or operating characteristics.

Factory setting: *linear*



Each auxiliary function, which is to be set, must be incorporated initially into the main menu (MAIN). See chapter “16.1 Activating and deactivating auxiliary functions” on page 88.

Enter the freely programmable characteristic as follows:

-  Press **MENU** for 3 s. Switching from process level ⇒ setting level.
- ▲ / ▼ Select **CHARACT**. (To do this, the auxiliary function must be incorporated into the main menu).
-  Select **ENTER**. Menu options of **CHARACT** are displayed.
- ▲ / ▼ **linear** (linear characteristic)
 - GP 1:25: Equal percentage characteristic 1:25
 - GP 1:33: Equal percentage characteristic 1:33
 - GP 1:50: Equal percentage characteristic 1:50
 - GP 25:1: Inversely equal percentage characteristic 25:1
 - GP 33:1: Inversely equal percentage characteristic 33:1
 - GP 50:1: Inversely equal percentage characteristic 50:1
 - FREE: * User-defined characteristic, freely programmable via nodes
-  Select **SELECT**. The selection is marked by a filled circle ●.
-  Select **EXIT**. Switching from setting level ⇒ process level.

The flow characteristic $k_v = f(s)$ indicates the flow-rate of a valve, expressed by the k_v value as a function of the stroke s of the actuator spindle. It is determined by the design of the valve seat and the seat seal. In general two types of flow characteristics are implemented, the linear and the equal percentage.

In the case of linear characteristics, equal k_v value changes dk_v are assigned to equal stroke changes ds .

$$(dk_v = n_{lin} \cdot ds).$$

In the case of an equal percentage characteristic, an equal percentage change of the k_v value corresponds to a stroke change ds .

$$(dk_v/k_v = n_{\text{equal percentage}} \cdot ds).$$

The operating characteristic $Q = f(s)$ specifies the correlation between the volumetric flow Q in the installed valve and the stroke s . This characteristic has the properties of the pipelines, pumps and consumers. It therefore exhibits a form which differs from the flow characteristic.

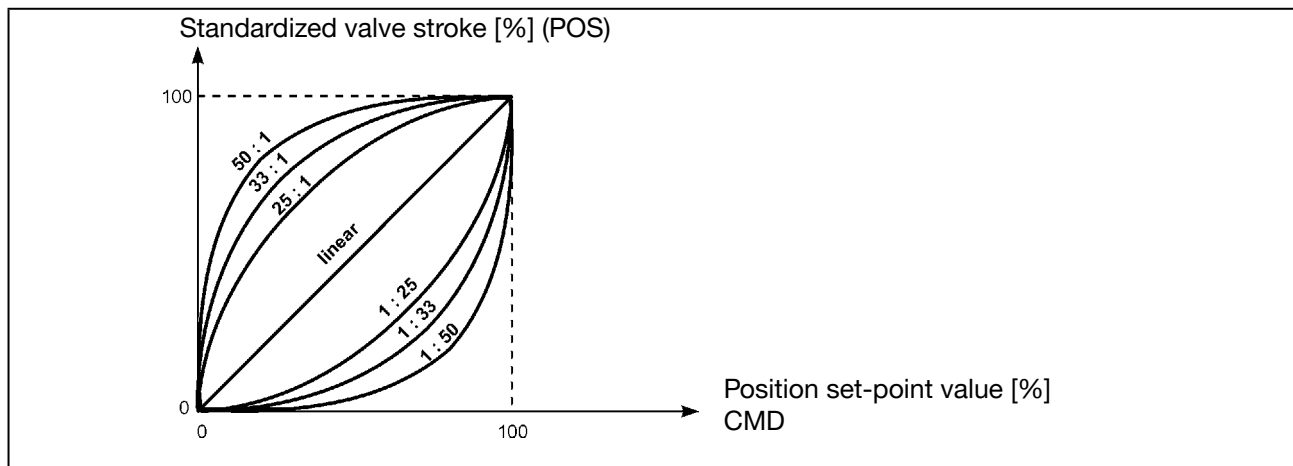

Figure 34: Characteristics





In the case of control tasks for closed-loop control systems it is usually particular demands which are placed on the course of the operating characteristic, e.g. linearity. For this reason it is occasionally necessary to correct the course of the operating characteristic in a suitable way. For this purpose Type 8792/8793 features a transfer element which implements different characteristics. These are used to correct the operating characteristic.

Equal percentage characteristics 1:25, 1:33, 1:50, 25:1, 33:1, and 50:1 and a linear characteristic can be set. Furthermore, a characteristic can be freely programmed via nodes or automatically calibrated.





16.1.3.1. Entering the freely programmable characteristic

The characteristic is defined via 21 nodes which are distributed uniformly over the position set-point value ranging from 0 – 100%. They are spaced at intervals of 5%. A freely selectable stroke (adjustment range 0 – 100%) can be assigned to each node. The difference between the stroke values of two adjacent nodes must not be greater than 20%.

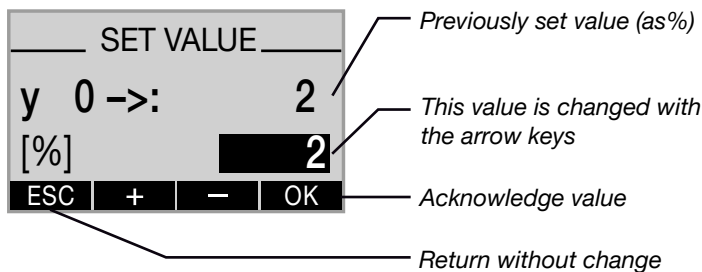
Enter the freely programmable characteristic as follows:

-  Press **MENU** for 3 s. Switching from process level ⇒ setting level.
- ▲ / ▼ Select **CHARACT**. To do this, the auxiliary function must be incorporated into the main menu.
-  Select **ENTER**. Menu options of **CHARACT** are displayed.
- ▲ / ▼ Select **FREE**
-  Select **SELEC**. The graphical display of the characteristic is displayed.
-  Select **INPUT**. Submenu with the individual nodes (as%) is opened.
- ▲ / ▼ Select node.
-  Select **INPUT**.
The **SET-VALUE** input screen for inputting values is opened.



- ▲ / ▼ Enter value: Enter value for the selected node.
 - + Increase value
 - Reduce value
 -  Select **OK**. Acknowledge input and return to the **FREE** submenu.
 -  Select **EXIT**. Return to the **CHARACT** menu.
 -  Select **EXIT**. Return to the main menu (**MAIN**).
 -  Select **EXIT**. Switching from setting level ⇒ process level.
The changed data is saved in the memory (EEPROM).
- ✓ You have entered the freely programmable characteristic.

 The changed data is saved in the memory (EEPROM) only when there is a switch to the process level, by leaving the main menu (**MAIN**) using the left selection key **EXIT**.

Example of a programmed characteristic

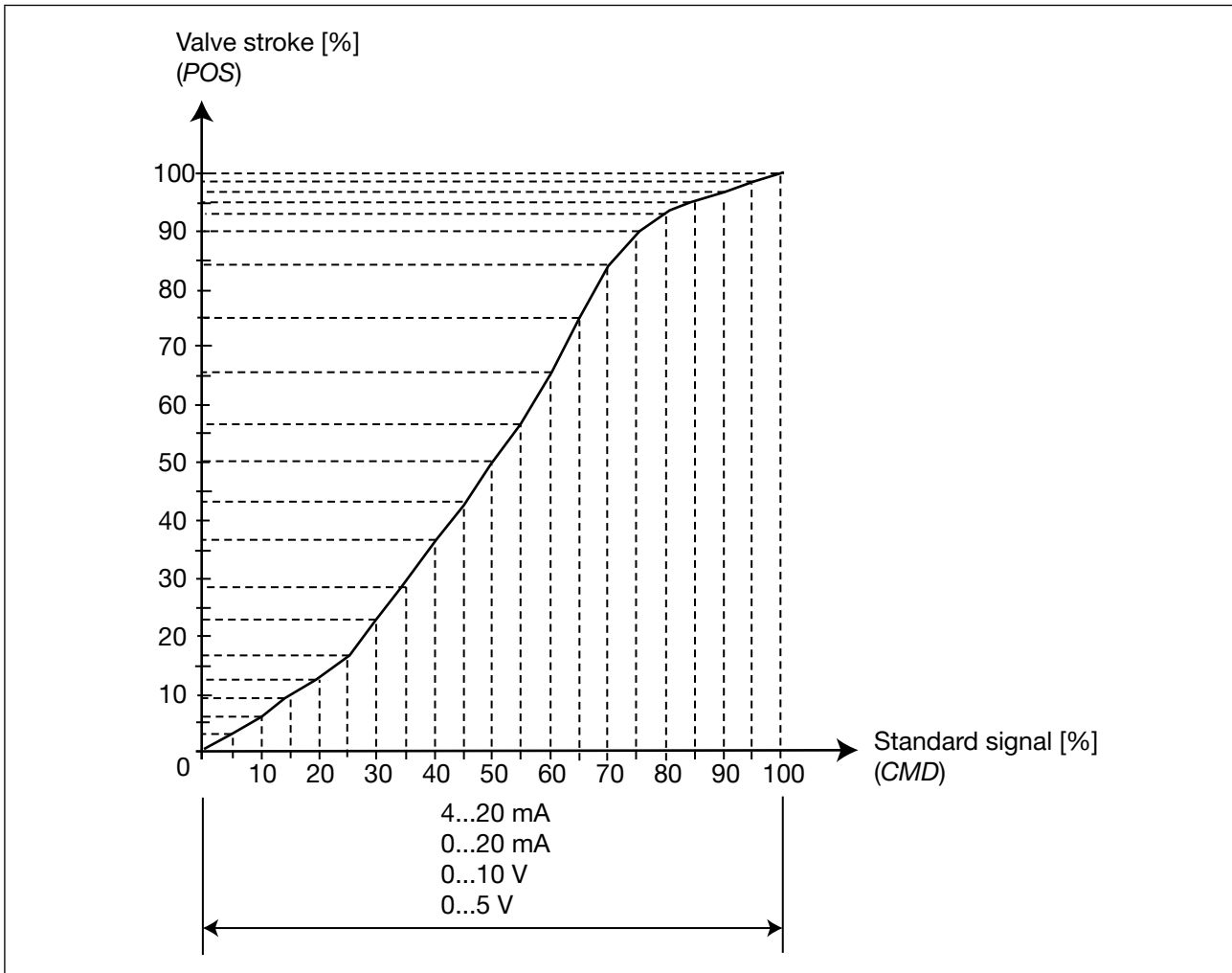

Figure 35: Example of a programmed characteristic



In the section [“Table for your settings on the positioner”](#) in chapter [“28.1 Settings of the freely programmed characteristic”](#) there is a table in which you can enter your settings for the freely programmable characteristic.

16.1.4 CUTOFF – Sealing function

This function causes the valve to be sealed outside the control range.

To do this, the limits for the set-point position (*CMD*) are entered as a percentage from which the actuator is fully deaerated or aerated.

Controlled operation opens or resumes at a hysteresis of 1%.

If the process valve is in the sealing area, the message “*CUTOFF ACTIVE*” is indicated on the display.

Only for Type 8793: Here you can select the set-point value to which the sealing function is to apply:





Type PCO Process set-point value (*SP*)

Type XCO Position set-point value (*CMD*)





If *Type PCO* was selected, the limits for the process set-point value (*SP*) are entered as a percentage with reference to the scaling range.

Factory setting: *Min = 0%*; *Max = 100%*; *CUT type = Type PCO*

Enter *CUTOFF* as follows:

-  Press **MENU** for 3 s. Switching from process level ⇒ setting level.
- ▲ / ▼ Select *CUTOFF*. (To do this, the auxiliary function must be incorporated into the main menu).
-  Select **ENTER**. Menu options of *CUTOFF* are displayed.
-  Select **INPUT**.
The *Min 0%* input screen for inputting values is opened.
- ▲ / ▼ Enter value: Enter value for the selected node.
 - + Increase value
 - Reduce value
-  Select **INPUT**.
The *Max 100%* input screen for inputting values is opened.
- ▲ / ▼ Enter value: Enter value for the selected node.
 - + Increase value
 - Reduce value
-  Select **OK**. Acknowledge input and return to the *CUTOFF* submenu.
* If the submenu is left by pressing the **ESC** key, the value remains unchanged.

Or for Type 8793:

-  Select **INPUT**.
The *CUT type** input screen for inputting values is opened.
*Available for Type 8793 only
-  Select **SELEC**. The *Type PCO* input screen for inputting the selection of the process set-point value.
-  Select **SELEC**. The *Type XCO* input screen for inputting the selection of the set-point position.
-  Select **EXIT**. Return to the *CUTOFF* menu.
-  Select **EXIT**. Return to the main menu (MAIN).

→  Select **EXIT**. Switching from setting level ⇒ process level.
The changed data is saved in the memory (EEPROM).

✔ You have entered the *CUTOFF* sealing function.

 The changed data is saved in the memory (EEPROM) only when there is a switch to the process level, by leaving the main menu (MAIN) using the left selection key **EXIT**.

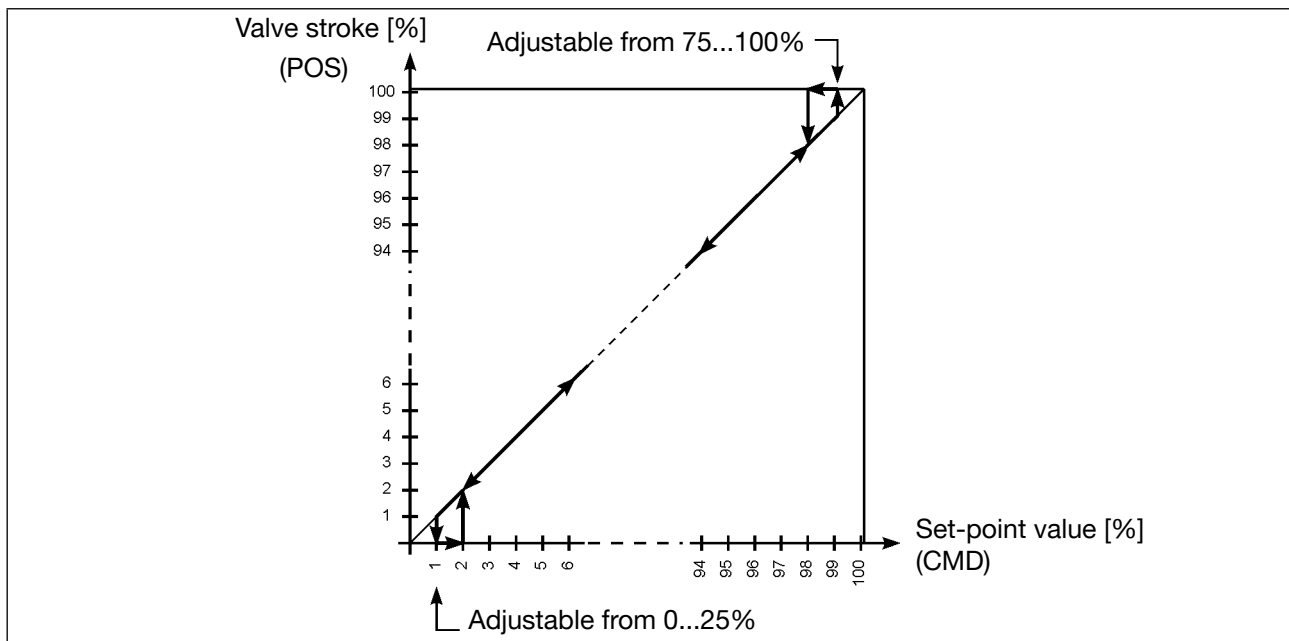

Figure 36: CUTOFF graph

16.1.5 DIR.CMD – Effective direction (Direction) of the positioner set-point value

You can use this auxiliary function to set the effective direction between the input signal (*INPUT*) and the set-point position (*CMD*) of the actuator.

! Each auxiliary function, which is to be set, must be incorporated initially into the main menu (*MAIN*). See chapter “16.1 Activating and deactivating auxiliary functions” on page 88.

Enter the effective direction of the position controller set-point value as follows: (Setting on the process level)

→ ▲ / ▼ Select *DIR.CMD*. The effective direction is indicated on the display.

→  Select **ENTER**. The input screen for inputting the effective direction is displayed.

→ ▲ / ▼ Select **SELEC**. *Rise*: direct effective direction
 (e.g. 4 mA or 0 V → 0%, 20 mA or 5/10 V → 100%)
Fall: inverse effective direction
 (e.g. 4 mA or 0 V → 100%, 20 mA or 5/10 V → 0%)
 The selection is marked by a filled circle ●.

→  Select **EXIT**. Acknowledge input and return to the display of *DIR.CMD*.

✔ You have entered the effective direction of the position controller set-point value.

! The changed data is saved in the memory (EEPROM) only when there is a switch to the process level, by leaving the main menu (*MAIN*) using the left selection key **EXIT**.

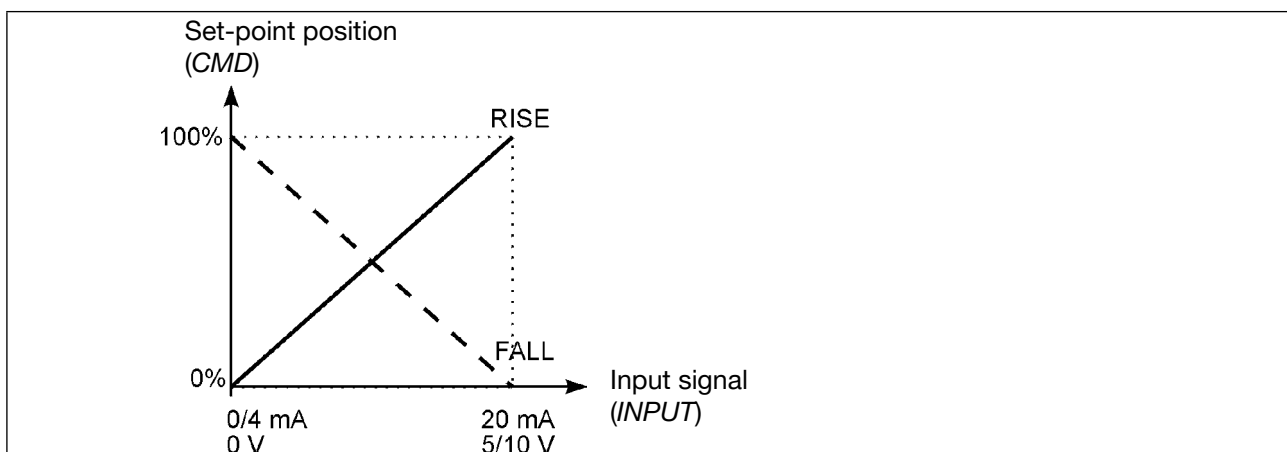

Figure 37: DIR.CMD graph

16.1.6 DIR.ACT – Effective direction of the actuating drive

Use this auxiliary function to set the effective direction between the aeration state of the actuator and the actual position (POS).

Factory setting: *Rise*

Enter the effective direction of the actuating drive as follows: (Setting on the process level)

→ ▲ / ▼ Select **DIR.ACT**. The effective direction is indicated on the display.

→  Select **ENTER**. The input screen for inputting the effective direction is displayed.

→ ▲ / ▼ Select **SELEC**. *Rise*: direct effective direction (deaerated → 0%; aerated 100%)
Fall: inverse effective direction (deaerated → 100%; aerated 0%)
 The selection is marked by a filled circle ●.

→  Select **EXIT**. Acknowledge input and return to the display of **DIR.ACT**.

✔ You have entered the effective direction of the actuating drive.



If the *Fall* function is selected here, the description of the arrow keys (on the display) is changed in the **MANUAL** operating state

OPN → **CLS** and **CLS** → **OPN**

The changed data is saved in the memory (EEPROM) only when there is a switch to the process level, by leaving the main menu (**MAIN**) using the left selection key **EXIT**.

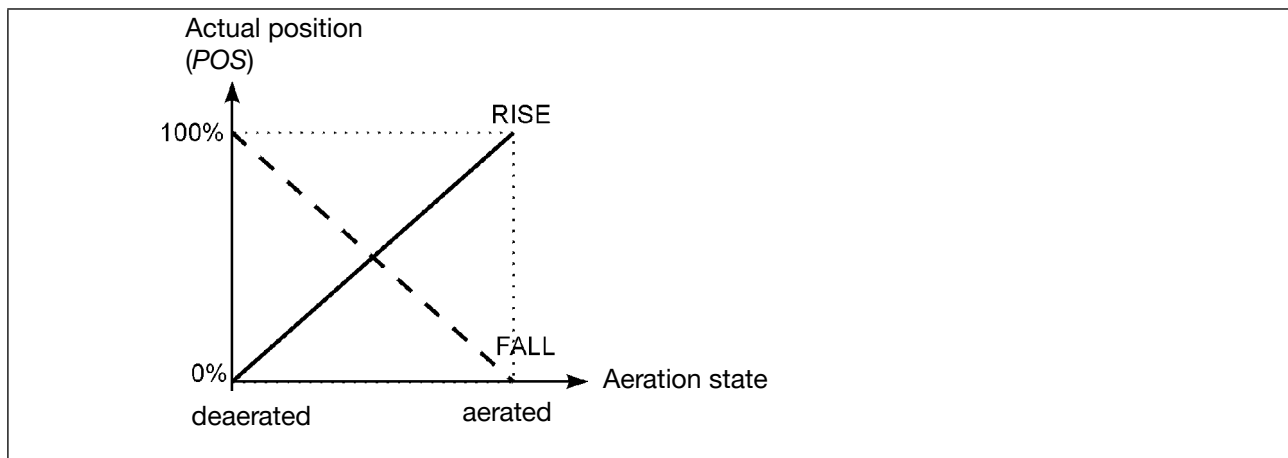

Figure 38: DIR.ACT graph

16.1.7 SPLTRNG – Signal split range

Min. and max. values of the input signal as% for which the valve runs through the entire stroke range.

Factory setting: $Min = 0\%$; $Max = 100\%$



Type 8793: The *SPLTRNG* auxiliary function can only be selected when operating as a positioner (position controller).





P.CONTROL = not activated.

Use this auxiliary function to limit the position set-point value range of Type 8792/8793 by specifying a minimum and a maximum value.

As a result, it is possible to split a used standard signal range (4 – 20 mA, 0 – 20 mA, 0 – 10 V or 0 – 5 V) over several devices (without or with overlapping).

This allows several valves to be used **alternately** or, in the case of overlapping set-point value ranges, **simultaneously** as actuators.

Enter the signal split range as follows (setting on the process level):

- ▲ / ▼ Select *SPLTRNG*. The effective direction is indicated on the display.
 -  Select **ENTER**. The input screen for inputting the effective direction is displayed.
 -  Select **INPUT**.
The *Min 0%* input screen for inputting values is opened.
 - ▲ / ▼ Enter value: Enter the minimum value of the input signal as%. Adjustment range: 0 – 75%
 - + Increase value
 - Reduce value
 -  Select **INPUT**.
The *Max 100%* input screen for inputting values is opened.
 - ▲ / ▼ Enter value: Input the maximum value of the input signal as%.
Adjustment range: 25 – 100%
 - + Increase value
 - Reduce value
 -  Select **OK** *. Acknowledge input and return to the display of *SPLTRNG*.
- ✔ You have entered the signal split range.

* If the submenu is left by pressing the **ESC** key, the value remains unchanged.



The changed data is saved in the memory (EEPROM) only when there is a switch to the process level, by leaving the main menu (**MAIN**) using the left selection key **EXIT**.

Splitting a standard signal range into two set-point value ranges

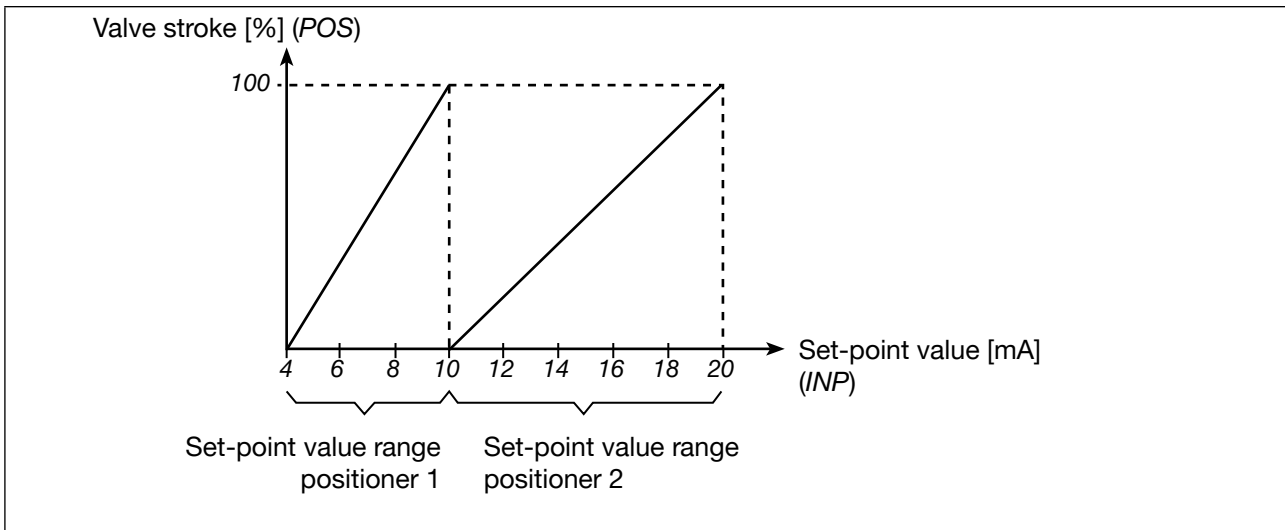

Figure 39: SPLTRNG graph

16.1.8 X.LIMIT – Limit of the mechanical stroke range

This auxiliary function limits the (physical) stroke to specified percentage values (minimum and maximum). In doing so, the stroke range of the limited stroke is set equal to 100%.

If the limited stroke range is left during operation, negative POS values or POS values greater than 100% are indicated.

Factory setting: $Min = 0\%$, $Max = 100\%$

Enter the limit of the mechanical stroke range as follows (setting on the process level):

- ▲ / ▼ Select **X.LIMIT**. The limit of the mechanical stroke range is indicated on the display.
- Select **ENTER**. The input screen for inputting the mechanical stroke range is displayed.
- Select **INPUT**.
The $Min = 0\%$ input screen for inputting values is opened.
- ▲ / ▼ Enter value: Input the initial value of the stroke range as%.
Adjustment range: 0 – 50% of the total stroke
 - Increase value
 - Reduce value
- Select **INPUT**.
The $Max = 100\%$ input screen for inputting values is opened.
- ▲ / ▼ Enter value: Input the final value of the stroke range as%.
Adjustment range: 50 – 100% of the total stroke
 - Increase value
 - Reduce value
- Select **OK** *. Acknowledge input and return to the display of **X.LIMIT**.
The minimum gap between Min and Max is 50%

You have entered the limit of the mechanical stroke range.

* If the submenu is left by pressing the ESC key, the value remains unchanged.



The changed data is saved in the memory (EEPROM) only when there is a switch to the process level, by leaving the main menu (MAIN) using the left selection key **EXIT**.

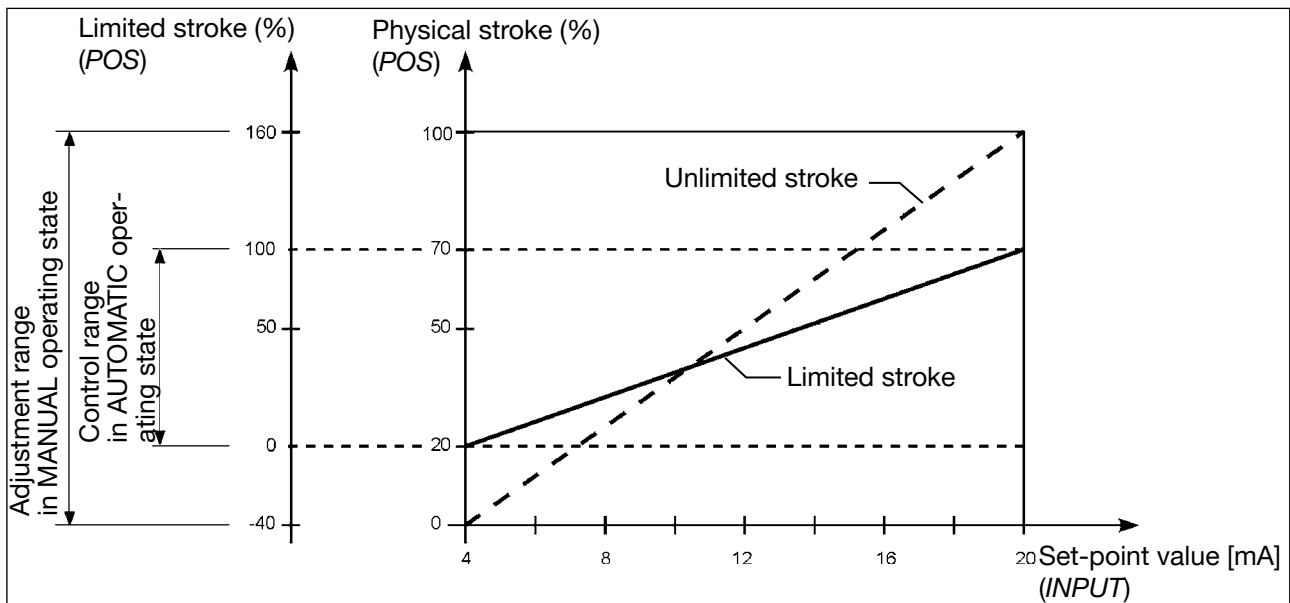

Figure 40: X.LIMIT graph

16.1.9 X.TIME – Limit of the control speed

Use this auxiliary function to specify the opening and closing times for the entire stroke and limit the control speeds.





When the X.TUNE function is running, the minimum opening and closing time for the entire stroke is automatically entered for *Open* and *Close*. Therefore, movement can be at maximum speed.

Factory setting: values determined at the factory by the X.TUNE function

If the control speed is limited, values can be entered for *Open* and *Close* which are between the minimum values determined by the X.TUNE and 60 s.

Enter the limit of the control speed as follows: (**Setting on the process level**)

- ▲ / ▼ Select X.TIME. The limit of the mechanical stroke range is indicated on the display.
-  Select **ENTER**. The input screen for inputting the limit of the control speed is displayed.
-  Select **INPUT**.
The *Open* 1 input screen for inputting values is opened.
- ▲ / ▼ Enter value: Opening time for total stroke (in seconds)
Adjustment range: 1 – 60 seconds
 - + Increase value
 - Reduce value
-  Select **INPUT**.
The *CLOSE* 1 input screen for inputting values is opened.

→ ▲ / ▼ Enter value: Closing time for total stroke (in seconds)

Adjustment range: 1 – 60 seconds

- + Increase value
- Reduce value

→  Select **OK** *. Acknowledge input and return to the display of X.TIME.

✔ You have entered the limit of the control speed.

* If the submenu is left by pressing the ESC key, the value remains unchanged.



The changed data is saved in the memory (EEPROM) only when there is a switch to the process level, by leaving the main menu (MAIN) using the left selection key **EXIT**.

Effect of limiting the opening speed when there is a jump in the set-point value

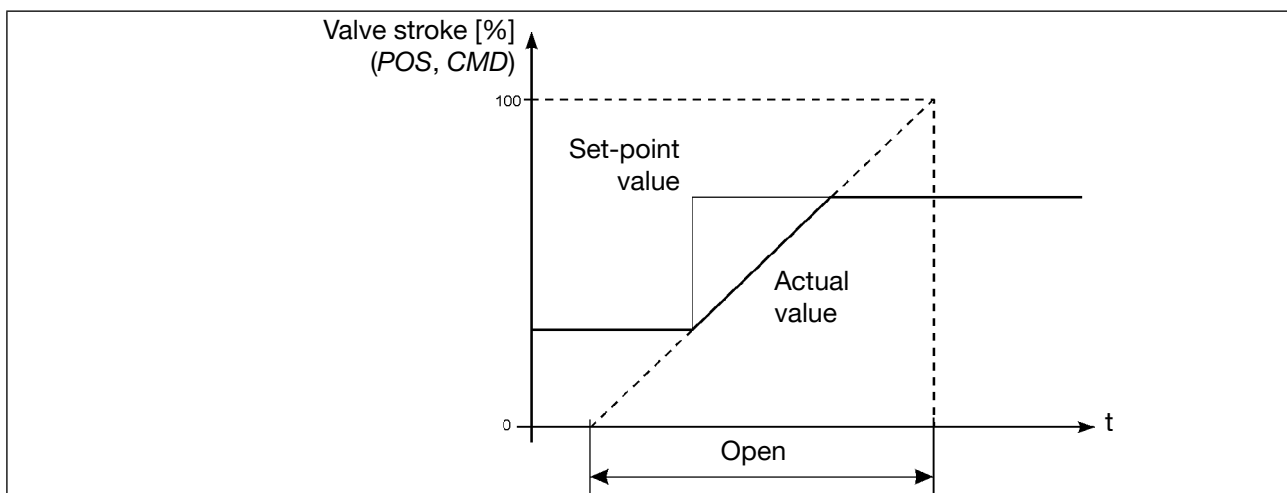

Figure 41: X.TIME graph

16.1.10 X.CONTROL – Parameterization of the positioner

This function can be used to re-adjust the parameters of the positioner. The re-adjustment should only be made if it is required for the application.

The parameters for X.CONTROL are automatically set with the exception of DBND (dead band) when specifying the basic settings by running X.TUNE.



If the setting for DBND (dead band depending on the friction behavior of the actuator) is also to be automatically determined when X.TUNE is running, X.CONTROL must be activated by incorporating it into the main menu (MAIN).

When X.TUNE is running, all previously re-adjusted values are overwritten (except the X.TUNE function was manually parameterized).

DBND	Insensitivity range (dead band)
KXopn	Amplification factor of the proportional portion (for aerating the valve)
KXcls	Amplification factor of the proportional portion (for bleeding the valve)
KDopn	Amplification factor of the differential portion (for aerating the valve)
KDcls	Amplification factor of the differential portion (for bleeding the valve)
YBfric	Friction correction (for aerating the valve)
YEfric	Friction correction (for bleeding the valve)

Enter the parameterization of the position controller as follows (setting on the process level):

- ▲ / ▼ Select **X.CONTROL**. The limit of the mechanical stroke range is indicated on the display.
- Select **ENTER**. The input screen for parameterization of the position controller is displayed.
- Select **INPUT**.
The input screen *DBND 1%, KXopn, KXcls, KDopn, KDcls, YBfric and YEfric* for inputting values is opened.
- ▲ / ▼ Enter value:
 - + Increase value
 - Reduce value
- Select **OK** *.

✔ You have entered the parameterization of the position controller.
* If the submenu is left by pressing the **ESC** key, the value remains unchanged.

DBND Insensitivity range (dead band) of the positioner

Input the dead band as %, with reference to the scaled stroke range;
i.e. $X.LIMIT\ Max - X.LIMIT\ Min$ (see auxiliary function “[16.1.8 X.LIMIT – Limit of the mechanical stroke range](#)”).

This function causes the controller to respond only from a specific control difference; as a result the solenoid valves in Type 8792/8793 and the pneumatic actuator are protected.

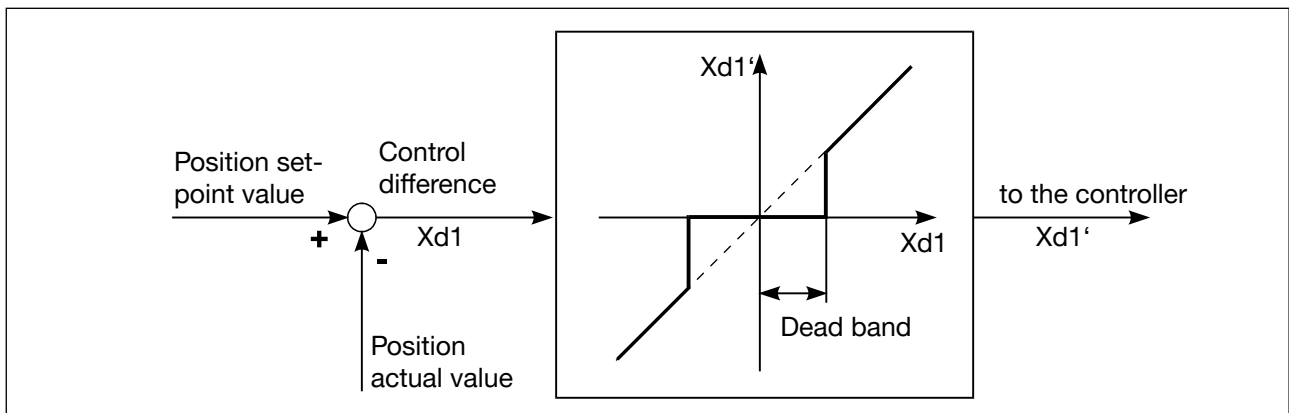

Figure 42: X.CONTROL graph

16.1.11 P.CONTROL – Setting up and parameterization of the process controller

Parameterization of the process controller is described in chapter “[15.1 P.CONTROL – Setting up and parameterization of the process controller](#)”.









16.1.12 SECURITY – Code protection for the settings

Use the *SECURITY* function to prevent Type 8792/8793 or individual functions from being accessed unintentionally.

Factory setting: *Access Code*: 0000

If the code protection is activated, the code (set *Access Code* or master code) must be input whenever operator action is disabled.

Set the code protection as follows:

-  Press **MENU** for 3 s. Switching from process level ⇒ setting level.
 - ▲ / ▼ Select **SECURITY** (To do this, the auxiliary function must be incorporated into the main menu).
 -  Select **ENTER**. The input screen for the access code (*Access Code*) is displayed.
 - ▲ / ▼ Select **<-** decimal place and **+** increase number.
Enter code.
For the first setting: *Access Code* 0000 (factory settings)
For activated code protection: *Access Code* from the user *
 -  Select **OK**. The submenu of *SECURITY* is opened.
 - ▲ / ▼ Select **CODE**.
 -  Select **INPUT**.
The input screen for specifying the access code (*Access Code*) is displayed.
 - ▲ / ▼ Select **<-** decimal place and **+** increase number.
Enter required access code.
 -  Select **OK**. Acknowledgment and return to the *SECURITY* menu.
 - Select ▲ / ▼. Select operator actions to which the code protection is to apply.
 -  Select **SELECT**. Activate code protection by checking the box .
 -  Select **EXIT**. Acknowledgment and simultaneous return to the main menu (MAIN).
 -  Select **EXIT**. Switching from setting level ⇒ process level.
-  You have set the code protection.



The changed data is saved in the memory (EEPROM) only when there is a switch to the process level, by leaving the main menu (MAIN) using the left selection key **EXIT**.



* If you have forgotten the set code:

All operator actions can be implemented with the non-changeable master code. This 4-digit master code can be found in the printed brief instructions for Type 8792/8793.

16.1.13 SAFEPOS – Inputting the safety position

This function specifies the actuator safety position which is started at defined signals.



The set safety position is only started

- if a corresponding signal is applied to the digital input (configuration see *chapter “16.1.15 BINARY.IN – Activation of the digital input”*) or
- if a signal fault occurs (configuration see *chapter “16.1.14 SIG.ERROR – Configuration of signal level fault detection”*).

In the case of the bus variant (EtherNet/IP, PROFINET, Modbus TCP, PROFIBUS DPV1 et bÜS) the safety position is also started with

- corresponding parameter telegram
- *BUS ERROR* (adjustable)

If the mechanical stroke range is limited with the *X.LIMIT* function, only safety positions within these limits can be started.

This function is run in **AUTOMATIC** operating state only.



Factory setting: 0%

Enter the safety position as follows: **(Setting on the process level)**

→ ▲ / ▼ Select **SAFEPOS**. (To do this, the auxiliary function must be incorporated into the main menu).

→  Select **ENTER**. The input screen for parameterization of the position controller is displayed.

→  Select **INPUT**.
Inputting the safety position adjustment range: 0 – 100%**

→ ▲ / ▼ Enter value:
 Increase value
 Reduce value

→  Select **OK** *.

✔ You have entered the safety position.

* If the submenu is left by pressing the **ESC** key, the value remains unchanged.

** If the safety position is 0% or 100%, the actuator is completely deaerated or aerated as soon as the safety position is active in the *SIG-ERROR* or *BINARY-IN* auxiliary functions.



The changed data is saved in the memory (EEPROM) only when there is a switch to the process level, by leaving the main menu (**MAIN**) using the left selection key **EXIT**.

16.1.14 SIG.ERROR – Configuration of signal level fault detection

The *SIG.ERROR* function is used to detect a fault on the input signal.

If signal fault detection is activated, the respective fault is indicated on the display.
(See chapter “22.3 Error messages”).

A fault detection on the input signal is only possible for signal types 4 -20 mA and Pt 100.
The particular menu branch is hidden for other signal types.

- **4 - 20 mA:** Fault if input signal ≤ 3.5 mA ($\pm 0.5\%$ of final value, hysteresis 0.5% of final value)
- **Pt 100** (can be set for process controller Type 8793 only):
Fault if input signal 225 °C ($\pm 0.5\%$ of final value, hysteresis 0.5% of final value)









The signal type is set in the following menus:







1. *INPUT* (for Types 8792 and 8793):
See chapter “14.2.1 INPUT - Setting the input signal”.
2. *P.CONTROL* (for Type 8793 only and when process controller activated):
See chapter “15.2.1 PV-INPUT – Specifying signal type for the process actual value”.

NOTE: The fault detection is only possible if the external set-point value default was selected in *SP-INPUT*. See chapter “15.2.3 SP-INPUT – Type of set-point value default (internal or external)”.

Set the signal fault detection for input signal as follows: (Setting on the process level)

- ▲ / ▼ Select *SIG.ERROR*. (To do this, the auxiliary function must be incorporated into the main menu).
-  Select **ENTER**. The input screen for setting the signal fault detection for input signal is displayed.
- ▲ / ▼ Select *SP/CMD Input*. *SP* = process set-point value, *CMD* = set-point position
-  Select **ENTER**.
- ▲ / ▼ Select *Error off* (deactivate signal fault detection).
Select *Error on* (activate signal fault detection).
-  Select **SELEC**. The selection is marked by a filled circle ●.
- ▲ / ▼ Select *SAFEPOS* (Deactivating/activating approach of the safety position*).
- ▲ / ▼ Select *SafePos off*.
Select *SafePos on***.
-  Select **SELEC**. The selection is marked by a filled circle ●.
-  Select **EXIT** and return to the *SP/CMD* input menu.
-  Select **EXIT** and return to the *SIG.ERROR* menu.

Only for type 8793 (process control):

- ▲ / ▼ Select *SIG.ERROR*. (To do this, the auxiliary function must be incorporated into the main menu).
-  Select **ENTER**. The input screen for setting the signal fault detection for input signal is displayed.
- ▲ / ▼ Select *PV-Input*. *PV = process actual value*
-  Select **ENTER**.
- ▲ / ▼ Select *Error off* (deactivate signal fault detection).
Select *Error on* (activate signal fault detection).
-  Select **SELEC**. The selection is marked by a filled circle ●.
- ▲ / ▼ Select *SAFEPOS* (Deactivating/activating approach of the safety position*).
- ▲ / ▼ Select *SafePos off*.
Select *SafePos on***.
-  Select **SELEC**. The selection is marked by a filled circle ●.
-  Select **EXIT** and return to the SP/CMD input menu.
-  Select **EXIT** and return to the SIG.ERROR menu.
- ✔ You have set the signal fault detection for input signal.

* Approaching the safety position can be set only when signal fault detection (Error on) has been activated. When signal fault detection (Error off) has been deactivated, the message “not available” is indicated.

** For behavior of the actuator during a signal fault detection see the following description.

16.1.14.1. Behavior of the actuator when safety position deactivated or activated

Selection *SafePos off* ● – The actuator moves to the set-point value according to the measured input signals (default setting): A faulty 4..20 mA signal is detected as 4.0 mA, a faulty Pt 100 signal is detected as 220 °C.

Selection *SafePos on* ● – Approaching the safety position:

In the event of a signal fault detection, the behavior of the actuator depends on the activation of *SAFEPOS* auxiliary function. See chapter “[16.1.13 SAFEPOS – Inputting the safety position](#)”.

- *SAFEPOS* activated: In the event of a signal fault detection the actuator moves to the position which is specified in the *SAFEPOS* auxiliary function.
- *SAFEPOS* not activated: The actuator moves to the safety end position which it would assume if the electrical auxiliary power failed.
See chapter “[10.8 Safety end positions after failure of the electrical or pneumatic auxiliary power](#)”.



The activation for approaching the safety position (selection *SafePos on*) is possible only when signal fault detection has been activated (*ERROR on*).

16.1.15 *BINARY.IN* – Activation of the digital input







The digital input is configured in this menu. The following functions can be assigned to it:

- SafePos Approaching *SafePos*
- Manu/Auto Switching over the operating state (MANUAL / AUTOMATIC)
- X.TUNE Starting the *X.TUNE* function

Only for Type 8793 and when process controller activated:

- X.CO/P.CO Switching between position and process controller

Activate the digital inputs as follows: (**Setting on the process level**)

- ▲ / ▼ Select *BINARY.IN*. (To do this, the auxiliary function must be incorporated into the main menu).
-  Select **ENTER**. The input screen for activating the digital inputs is displayed.
- ▲ / ▼ Select different *BIN.IN*.
Select *SafePos*. Approaching *SafePos*,
select *Manu/Auto*. Switch over operating state,
select *X.Tune*. Start *X.TUNE*, select
X.CO / P.CO . Switching between position controller and process controller or
select *BIN.IN type* and activate *normally open or normally closed* .
-  Select **SELECT**. The selection is marked by a filled circle .
-  Select **EXIT**.
-  Select **EXIT**. Switching from setting level \Rightarrow process level.
-  You have activated the digital inputs.

SafePos – Approaching a safety position:

The behavior of the actuator depends on the activation of the *SAFEPOS* auxiliary function. See chapter [“16.1.13 SAFEPOS – Inputting the safety position”](#).

SAFEPOS activated: The actuator moves to the safety position which is specified in the *SAFEPOS* auxiliary function.

SAFEPOS deactivated: The actuator moves to the safety end position which it would assume if the electrical and pneumatic auxiliary power failed.
See chapter [“10.8 Safety end positions after failure of the electrical or pneumatic auxiliary power”](#).

Digital input = 1 → Actuator moves to the set safety position.

Manu/Auto – Switching between the MANUAL and AUTOMATIC operating states:

Digital input = 0 → AUTOMATIC operating state AUTO

Digital input = 1 → MANUAL operating state MANU



If the *Manu/Auto* function was selected in the *BINARY.IN* menu, it is no longer possible to change the operating state on the process level using the **MANU** and **AUTO** keys.

X.TUNE – Starting the *X.TUNE* function:

Digital input = 1 → Start *X.TUNE*

X.CO/P.CO – Switching between position controller and process controller:

This menu option stands only for Type 8793 and is available when process controller (*P.CONTROL*) has been activated.

Digital input = 0 → Position controller (*X.CO*)

Digital input = 1 → Process controller (*P.CO*)

16.1.16 OUTPUT – Configuration of the outputs (option)



The *OUTPUT* menu option is only indicated in the selection menu of *ADD.FUNCTION* if Type 8792/8793 has outputs (option).

Type 8792/8793, which has the outputs option, is available in the following variants:

- one analog output
- one analog output and two digital outputs
- two digital outputs



According to the variant of Type 8792/8793, only the possible adjustable outputs (*ANALOG*, *ANALOG + BIN 1 + BIN 2* or *BIN 1 + BIN 2*) are indicated in the *OUTPUT* menu option.

Configure the outputs as follows: (Setting on the process level)

→ ▲ / ▼ Select *OUTPUT*. (To do this, the auxiliary function must be incorporated into the main menu).

→  Select **ENTER**. The input screen for configuring the outputs is displayed.

→ ▲ / ▼ Select *OUT ANALOG*.

→  Select **ENTER** and configure the analog output.

→ ▲ / ▼ Select *OUT BIN1*.

→  Select **ENTER** and configure the digital output 1.

→ ▲ / ▼ Select *OUT BIN2*.

→  Select **ENTER** and configure the digital output 2.

→  Select **EXIT**. Switching from setting level ⇒ process level.









✔ You have configured the outputs.

16.1.16.1. OUT ANALOG - Configuration of the analog output

Type 8792: The feedback of the current position (*POS*) or of the set-point value (*CMD*) can be transmitted to the control center via the analog output.

Type 8793: The feedback of the current position (*POS*) or of the set-point value (*CMD*), of the process actual value (*PV*) or of the process set-point value (*SP*) can be transmitted to the control center via the analog output.

Configure the analog output as follows: (Setting on the process level)

- ▲ / ▼ Select *OUT ANALOG*. (To do this, the auxiliary function must be incorporated into the main menu).
-  Select **ENTER**. The input screen for configuring the analog output is displayed.
- ▲ / ▼ Select *POS*. Output of the actual position.
-  Select **SELEC**. The selection is marked by a filled circle ●.
- ▲ / ▼ Select *CMD*. Output of the set-point position.
-  Select **SELEC**. The selection is marked by a filled circle ●.
- ▲ / ▼ Select *PV*. Output of the process actual value. (**Only for Type 8793, process control**)
-  Select **SELEC**. The selection is marked by a filled circle ●.
- ▲ / ▼ Select *SP*. (**Only for Type 8793 (process control)**)
-  Select **SELEC**. Output of the process set-point value.
- ▲ / ▼ Select *OUT.type*. Selection of the standard signal.
-  Select **ENTER** and configure the standard signal.
- ▲ / ▼ Select standard signal.
-  Select **SELECT**. The selection is marked by a filled circle ●.
-  Select **EXIT** and return to the *OUT.type* menu.
-  Select **EXIT** and return to the *OUT ANALOG* menu.
- ✔ You have configured the analog output.

16.1.16.2. OUT BIN1 / OUT BIN2 - Configuring the digital outputs

The following description is valid for both digital outputs *OUT BIN 1* and *OUT BIN 2*, as the operation in the menu is identical.

The digital outputs 1 and 2 can be used for one of the following outputs:

- POS.Dev Exceeding the permitted control deviation
- POS.Lim-1/2 Current position with respect to a specified limit position (> or <)
- Safepos Actuator is moved to safety position
- ERR.SP/CMD Sensor break (SP = process set-point value / CMD = set-point value position)
- ERR.PV Sensor break (process actual value). **Available for Type 8793 only.**
- Remote Operating state (AUTOMATIC / MANUAL)
- Tune.Status Status *X.TUNE* (process optimization)
- DIAG.State-1/2 Diagnostic output (option)

Overview of possible outputs and associated switching signals:

Menu option	Switching signal	Description
POS.Dev	0	Control deviation is within the set limit.
	1	Control deviation is outside the set limit.
POS.Lim-1/2	0	Actual position is above the limit position.
	1	Actual position is below the limit position.
Safepos	0	Safety position is not approached.
	1	Safety position is approached.
ERR.SP/CMD	0	No sensor break available.
ERR.PV	1	Sensor break available.
Remote	0	Appliance is the AUTOMATIC operating state.
	1	Appliance is the MANUAL operating state.
Tune.Status	0	The <i>X.TUNE</i> function is currently not running.
	1	The <i>X.TUNE</i> function is currently running.
	0/1 alternating (10 s)	The <i>X.TUNE</i> function was stopped during execution by a fault.
DIAG.State-1/2	0	No diagnostic message available for the selected status signals.
	1	Diagnostic message available for the selected status signals.



Table 33: OUT BIN 1/2; possible outputs and associated switching signals

Switching signal	Switching statuses	
	normally open	normally closed
0	0 V	24 V
1	24 V	0 V

Table 34: OUT BIN 1/2; switching statuses

16.1.16.3. Setting of the submenu options of *OUT BIN 1* and *OUT BIN 2*





Open the submenus as follows:

-  Press **MENU** for 3 s. Switching from process level ⇒ setting level.
- ▲ / ▼ Select *OUTPUT* (to do this, the auxiliary function must be incorporated into the main menu).
-  Select **ENTER**. The outputs are displayed.
- ▲ / ▼ Select *OUT BIN1/2*
-  Select **ENTER**. Submenu options of *OUT BIN 1/2* are displayed.
- ✔ You have opened the submenus.





- *POS.Dev* - Alarm output for excessively large control deviation of the position controller
- *POS.Lim-1/2* - Output of the current position with respect to a specified limit position

Set the suboptions *OUT BIN 1* and *OUT BIN 2*:

POS.Dev - Alarm output for excessively large control deviation of the position controller:

- ▲ / ▼ Select *POS.Dev*
-  Select **SELEC**. The input screen for the limit value (*Deviation:*) is opened.
- ▲ / ▼  Increase value
 Reduce value
 Enter limit value for permitted control deviation.
 Adjustment range: 1 – 50% (must not be less than the dead band).
-  Select **OK**. Acknowledgment and simultaneous return to the *OUT BIN 1/2* menu.
 Then set the required switching status in the *OUT.type* submenu.

POS.Lim-1/2 - Output of the current position with respect to a specified limit position:

- ▲ / ▼ Select *POS.Lim-1/2*
-  Select **SELEC**. The input screen for the limit position (*Limit:*) is opened.
- ▲ / ▼  Increase value
 Reduce value
 Enter limit position.
 Adjustment range: 0 – 100%.
-  Select **OK**. Acknowledgment and simultaneous return to the *OUT BIN 1/2* menu.
 Then set the required switching status in the *OUT.type* submenu.
- ✔ You have set the submenus.

- The digital outputs are equipped with a hysteresis of 1%.
- This hysteresis must be observed when setting the switching thresholds for the digital outputs.
- Example: digital output 1 switches when POS < 4% falls short and digital output 2 when POS > 96% is exceeded.

Digital output 1 (OUT.BIN1): Hysteresis for lower switching threshold 4% → Normally Open, Output signal high when signal active

POS.LIM = 4 %
 POS.LIM = 4 %

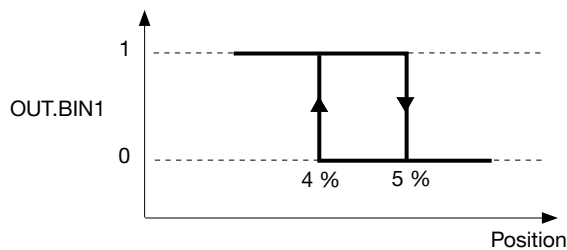

Digital output 2 (OUT.BIN2): Hysteresis for upper switching threshold 96% → Normally Closed, Output signal low when signal active

POS.LIM = 95 %
 POS.LIM = 95 %

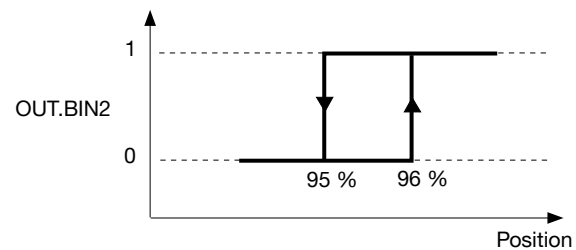

- **Safepos** - Outputting the message: Actuator in safety position
- **ERR.SP/CMD** - Outputting the message: Sensor break for process set-point value/set-point position
 Only available if the function in the *SIG.ERR* menu has been activated (*SIG.ERR* → *SP/CMD input* → *Error on*).
 See chapter “16.1.14 SIG.ERROR – Configuration of signal level fault detection”.
- **ERR.PV** - Outputting the message: Sensor break for process actual value (for Type 8793 only)
 Only available if the function in the *SIG.ERR* menu has been activated (*SIG.ERR* → *PV Input* → *Error on*).
 See chapter “16.1.14 SIG.ERROR – Configuration of signal level fault detection”
- **Remote** - Output AUTOMATIC / MANUAL operating state
- **Tune.Status** - Output TUNE (process optimization)

Specify the output as follows:

→ ▲ / ▼ Select *suboptions*. (*Safepos*, *ERR.SP/CMD*, *ERR.PV*, *Remote* or *Tune.Status*).

→ Select **SELEC**. Acknowledge submenu option as output function for the digital output. The selection is marked by a filled circle ●. Then set the required switching status in the *OUT.type* submenu.

✔ You have specified the output.

• **DIAG.State-1/2 - Diagnostic output (option)**

Outputting the message: Diagnostic message from selected status signal

For description see chapter “16.1.24 DIAGNOSE – Menu for monitoring valves (option)”.

Enter the **OUT.type** as follows:

→ ▲ / ▼ Select **DIAG.State-1/2**.

→  Select **SELEC**. The status signals, which can be activated for outputting the message, are displayed.

→ ▲ / ▼ Select **status signal**. Select the status signal which is to be assigned to the diagnostic output.

→  Select **SELEC**. Activate the selection by checking the box or deactivate it by unchecking the box .

→ If required, activate further status signals for the diagnostic output by pressing the ▲ / ▼ and **SELEC** keys.

→  Select **EXIT**. Acknowledgment and simultaneous return to the **OUT BIN 1/2** menu. Then set the required switching status in the **OUT.type** submenu.

✔ You have entered **OUT.type**.

• **OUT.type - Setting the switching status**

In addition to selecting the output, the switching status required for the digital output must be entered.

See following “Table 35”.

Enter the **OUT.type** as follows:

→ ▲ / ▼ Select **OUT.type**.

→  Select **SELEC**. The switching statuses *normally open* and *normally closed* are displayed.

→ ▲ / ▼ Select switching status.

→  Select **SELEC**. The selection is marked by a filled circle ●.

→  Select **EXIT**. Acknowledgment and simultaneous return to the **OUT BIN 1/2** menu.

→  Select **EXIT**. Acknowledgment and simultaneous return to the **OUTPUT** menu.

→  Select **EXIT**. Acknowledgment and simultaneous return to the main menu (MAIN).

→  Select **EXIT**. Switching from setting level ⇒ process level.

✔ You have entered **OUT.type**.

Switching signal	Switching statuses	
	normally open	normally closed
0	0 V	24 V
1	24 V	0 V

Table 35: **OUT BIN 1/2; switching statuses**

 The changed data is saved in the memory (EEPROM) only when there is a switch to the process level, by leaving the main menu (MAIN) using the left selection key **EXIT**.

16.1.17 CAL.USER – Calibration of actual value and set-point value

The following values can be manually calibrated with this function:

- Position actual value (0 - 100%)
- Set-point position (4 - 20 mA, 0 - 20 mA, 0 - 5 V, 0 - 10 V)
For the calibration process the signal type is displayed which was specified for the input signal.
See chapter [“14.2.1 INPUT - Setting the input signal”](#).

Type 8793:

The following values can be calibrated only for Type 8793 and activated process controller (*P.CONTROL*).

- Process set-point value (4 - 20 mA, 0 - 20 mA, 0 - 5 V, 0 - 10 V)
For the calibration process the signal type is displayed which was specified for the input signal.
See chapter [“14.2.1 INPUT - Setting the input signal”](#).



The calibration of the process set-point value is only possible if the external set-point value default was selected when setting up the process controller.

See chapter [“15.2.3 SP-INPUT – Type of set-point value default \(internal or external\)”](#).

Setting: *P.CONTROL* → *SETUP* → *SP-INPUT* → *external*

- Process actual value (4 - 20 mA or *C)
For the calibration process the signal type is displayed which was specified for the process actual value when setting up the process controller.
See chapter [“15.2.1 PV-INPUT – Specifying signal type for the process actual value”](#).





The frequency signal type (flow rate) cannot be calibrated.





If the frequency was set when setting up the process controller (*P.CONTROL* → *SETUP* → *PV-INPUT* → *Frequency*), the *calibr. PV* menu option is hidden.





16.1.17.1. Calibration of the position actual value and the set-point position

Calibrate *CAL.USER* as follows:







-  Press **MENU** for 3 s. Switching from process level ⇒ setting level.
-  Select *CAL.USER*. (To do this, the auxiliary function must be incorporated into the main menu).
-  Select **ENTER**. The submenu options are displayed.

calibr. POS - Calibration of the position actual value (0 – 100%):

-  Select *calibr.POS*.
-  Select **ENTER**. The menu options for the minimum and the maximum position actual values are displayed.
-  Select *POS. pMin*.
-  Select **INPUT**. The input screen for the lower value (*POS.lower*) is opened.
-  Select **OPN** open more
CLS close more. Approach minimum position of the valve.



-  Select **OK**. Transfer and simultaneous return to the *calibr.POS* menu.
- ▲ / ▼ Select *POS. pMax*.
-  Select **INPUT**. The input screen for the upper value (*POS.upper*) is opened.
- ▲ / ▼ Select **OPN** open more
CLS close more. Approach maximum position of the valve.
-  Select **OK**. Transfer and simultaneous return to the *calibr.POS* menu.
-  Select **EXIT**. Acknowledgment and simultaneous return to the *CAL.USER* menu.

calibr. INP - Calibration of the set-point position (4 – 20 mA, 0 – 20 mA, 0 – 5 V, 0 – 10 V):

- ▲ / ▼ Select *calibr.INP*.
-  Select **ENTER**. The menu options for the minimum and maximum value of the input signal are displayed.
- ▲ / ▼ Select *INP 0 mA (4mA/0V)*. The minimum value for the input signal is displayed.
- Apply the minimum value to the input.
-  Select **OK**. Transfer and simultaneous return to the *calibr.INP* menu.
- ▲ / ▼ Select *INP 20 mA (5V/10V)*. The maximum value for the input signal is displayed.
- Apply the maximum value to the input.
-  Select **OK**. Transfer and simultaneous return to the *calibr.INP* menu.
-  Select **EXIT**. Acknowledgment and simultaneous return to the *CAL.USER* menu.
-  Select **EXIT**. Acknowledgment and simultaneous return to the main menu (MAIN).
-  Select **EXIT**. Switching from setting level ⇒ process level.
- ✔ You have calibrated *CAL.USER*.



16.1.17.2. Calibration of the process set-point value and the process actual value

Calibrate *CAL.USER* as follows:





-  Press **MENU** for 3 s. Switching from process level ⇒ setting level.
- ▲ / ▼ Select *CAL.USER*. (To do this, the auxiliary function must be incorporated into the main menu).
-  Select **ENTER**. The submenu options are displayed.

calibr. SP - Calibration of the process set-point value:





- ▲ / ▼ Select *calibr. SP*.
-  Select **ENTER**. The menu options for the minimum and the maximum process set-point value are displayed.
- ▲ / ▼ Select *SP 0 mA (4mA/0V)*. The minimum value for the input signal is displayed.
- Apply the minimum value to the input.

-  Select **OK**. Transfer and simultaneous return to the *calibr.SP* menu.
- ▲ / ▼ Select *SP 20 mA (5V/10V)*. The maximum value for the input signal is displayed.
- Apply the maximum value to the input.
-  Select **OK**. Transfer and simultaneous return to the *calibr.SP* menu.
-  Select **EXIT**. Acknowledgment and simultaneous return to the *CAL.USER* menu.

calibr. PV - Calibration of the process actual value for input signal 4 – 20 mA:







- ▲ / ▼ Select *calibr. PV*.
-  Select **ENTER**. The menu options for the minimum and the maximum process actual value are displayed.
- ▲ / ▼ Select *PV 4 mA*. The minimum value for the input signal is displayed.
- Apply the minimum value to the input.
-  Select **OK**. Transfer and simultaneous return to the *calibr.PV* menu.
- ▲ / ▼ Select *PV 20mA*. The maximum value for the input signal is displayed.
- Apply the maximum value to the input.
-  Select **OK**. Transfer and simultaneous return to the *calibr.PV* menu.
-  Select **EXIT**. Acknowledgment and simultaneous return to the *CAL.USER* menu.

calibr. PV - Calibration of the process actual value for input signal Pt 100:

- ▲ / ▼ Select *calibr.PV*.
-  Select **ENTER**. The input screen for calibration of the temperature is opened.
- ▲ / ▼ Select **<-** decimal place and **+** increase number.
Enter the current temperature.
-  Select **OK**. Transfer and simultaneous return to the *CAL.USER* menu.
-  Select **EXIT**. Acknowledgment and simultaneous return to the main menu (MAIN).
-  Select **EXIT**. Switching from setting level ⇒ process level.
- ✔ You have calibrated *CAL.USER*.

16.1.17.3. Resetting the settings under *CAL.USER* to the factory settings

Reset the settings as follows:

-  Press **MENU** for 3 s. Switching from process level ⇒ setting level.
 - ▲ / ▼ Select *CAL.USER*. (To do this, the auxiliary function must be incorporated into the main menu).
 -  Select **ENTER**. The submenu options are displayed.
 - ▲ / ▼ Select *copy FACT->USER*.
 -  Select **RUN**. Hold down as long as countdown (5 ...) is running. The settings of *CAL.USER* are reset to the factory settings.
 -  Select **EXIT**. Acknowledgment and simultaneous return to the main menu (MAIN).
 -  Select **EXIT**. Switching from setting level ⇒ process level.
-  You have reset the settings.







The factory calibration is re-activated by deactivating *CAL.USER*, by removing the auxiliary function from the main menu (MAIN).

16.1.18 *SET.FACTORY* – Reset to factory settings

This function allows all settings implemented by the user to be reset to the delivery status.

All EEPROM parameters with the exception of the calibration values are reset to default values. Then a hardware reset is implemented.

Reset the settings to factory setting as follows:

-  Press **MENU** for 3 s. Switching from process level ⇒ setting level.
 - ▲ / ▼ Select *SET.FACTORY*. (To do this, the auxiliary function must be incorporated into the main menu).
 -  Press **RUN** for 3 s (until progress bar is closed) “factory reset” is shown. Reset is implemented.
 -  Select **EXIT**. Switching from setting level ⇒ process level.
-  You have reset the settings.





To adjust Type 8792/8793 to the operating parameters, re-implement self-parameterization of the positioner (*X.TUNE*).

16.1.19 SERVICE.BUES – Setting the service interface

Set the service interface as follows:

→  Press **MENU** for 3 s. Switching from process level ⇒ setting level.

→  Select *SERVICE.BUES*.

→  Select **ENTER**. The possible BUES are displayed.

Select baud rate:

→  Select *baud rate*.

→  Select **ENTER**. The possible *baud rates* are displayed.

 Select *baud rate* 1000 kbit/s
 500 kbit/s
 250 kbit/s
 125 kbit/s
 50 kbit/s.

→  Select **OK**. Return to BUS.COMM.

Setting device address:

→  Select *address*.

→  Select **INPUT**. The possible *addresses* are displayed.

→  Select **+** Increase value or **-** reduce value.
 Enter a device address (*value between 0 and 127*).

→  Select **SELECT**. The selected address is now marked by a filled circle ●.

→  Select **EXIT**. Switching from setting level ⇒ process level.











✔ You have set the service interface.

16.1.20 EXTRAS – Setting the display

This function can be used to individually set the display.

- In *DISP.ITEMS* the display of the process level can be individually set.
 To do this, further menu options can be activated for the display of the process level. *POS* and *CMD* are activated in the as-delivered state.
- In *START-UP.ITEM* one of the activated menu options is specified as a start display after a restart.
- The type of display is selected via *DISP.MODE*.
normal = black font on light background.
inverse = white font on dark background.
- *DISP.LIGHT* is used to define the background lighting of the display.
on = Background lighting on.
off = Background lighting off.
user active = Background lighting switches off after 10 seconds with no user interaction. If a key is pressed again, the background lighting goes on again.

Activate the menu displays for displaying the process level as follows:

-  Press **MENU** for 3 s. Switching from process level ⇒ setting level.
 - ▲ / ▼ Select *ADD.FUNCTION*.
 -  Select **ENTER**. The possible auxiliary functions are displayed.
 - ▲ / ▼ Select *EXTRAS*.
 -  Select **ENTER**.
Activate the *EXTRAS* auxiliary function by checking the box and transfer into the main menu.
 -  Select **EXIT**. Return to the main menu (MAIN).
 - ▲ / ▼ Select *EXTRAS*.
 -  Select **ENTER**. The submenus of *EXTRAS* are displayed.
 - ▲ / ▼ Select *DIP.ITEMS*.
 -  Select **ENTER**.
The possible menu options are displayed.
POS, CMD, CMDIPOS, CMD/POS(t), CLOCK, INPUT, TEMP, X.TUNE.
Additionally for process controller Type 8793:
PV, SP, SPIPV, SP/PV(t), P.TUNE, P.LIN.
 - ▲ / ▼ Select required menu options.
 -  Select **SELEC**. Activate the selection by checking the box or deactivate it by unchecking the box .
 -  Select **EXIT**. Return to the *EXTRAS* menu.
 -  Select **EXIT**. Return to the main menu (MAIN).
 -  Select **EXIT**. Switching from setting level ⇒ process level.
- ✔ You have activated the menu display.

The activated menu options are now displayed on the process level display.

Use the arrow keys ▲ ▼ to switch between the displays.

 Each menu option which can be selected can also be deactivated so that it is not indicated on the process level display.
However, there must be at least one menu option available which can be indicated on the display.
If nothing was selected, the *POS* menu option is automatically activated.

START-UP.ITEM - Specifying menu option for the start display:









EXTRAS → **START-UP.ITEM** ▲ / ▼ Select menu option and specify with **SELEC**.

The menu option for the start display is marked by the filled circle ●.

The detailed procedure can be found in the extensive menu description for *DISP.ITEMS*. The *START-UP.ITEM* and *DISP.ITEMS* menus are set in the same way.

DISP.MODE - Select type of display
(black font on light background or white font on dark background):

Select the type of display as follows:

-  Press **MENU** for 3 s. Switching from process level ⇒ setting level.
 - ▲ / ▼ Select **ADD.FUNCTION**.
 -  Select **ENTER**. The possible auxiliary functions are displayed.
 - ▲ / ▼ Select **EXTRAS**.
 -  Select **ENTER**.
Activate the **EXTRAS** auxiliary function by checking the box and transfer into the main menu.
 -  Select **EXIT**. Return to the main menu (MAIN).
 - ▲ / ▼ Select **DISP.MODE**.
 -  Select **ENTER**.
The possible menu options for the type of display are shown.
normal = black font on light background
inverse = white font on dark background
 - ▲ / ▼ Select the type of display.
 -  Select **SELEC**.
The selection is marked by a filled circle ●.
 -  Select **EXIT**. Return to the **EXTRAS** menu.
 -  Select **EXIT**. Return to the main menu (MAIN).
 -  Select **EXIT**. Switching from setting level ⇒ process level.
- ✔ You have set the type of display.

DISP.LIGHT - Define background lighting for display:

EXTRAS → **DISP.LIGHT** ▲ / ▼ Background lighting and specify with **SELEC**.

The menu option for the background lighting is marked by the filled circle ●.

- on* = Background lighting on.
- off* = Background lighting off.
- user active* = Background lighting switches off after 10 seconds with no user interaction. If a key is pressed again, the background lighting goes on again.

The detailed procedure can be found in the extensive menu description for **DISP.MODE**. The **DISP.LIGHT** and **DISP.MODE** menus are set in the same way.

16.1.21 POS.SENSOR

Setting interface remote position sensor

The interface for the connection of an external position sensor can be selected in this menu.



The following connection options are possible:

Interface	Position sensor	Setting in the menu (ADD.FUNCTION)
digital (serial)	Remote sensor Type 8798.	POS.SENSOR → DIGITAL
analog (4 - 20 mA) *	any high-resolution position sensor.	POS.SENSOR → ANALOG

Table 36: Connection options Type 8793 with external position sensor

 * If the external position sensor is connected to the process controller Type 8793 via the analog interface, it can be operated only as a positioner (position controller).
The P.CONTROL auxiliary function is automatically removed.

Setting the interface remote position sensor:

-  Press **MENU** for 3 s. Switching from process level ⇔ setting level.
- ▲ / ▼ Select **POS.SENSOR**. (To do this, the auxiliary function must be incorporated into the main menu).
-  Select **ENTER**. The submenu options are displayed.
- ▲ / ▼ Select **DIGITAL**.
-  Select **ENTER**.

The position signal of the external position sensor is digitally transmitted

Digital interface (menu option **POS.SENSOR → DIGITAL**):

Type 8792/8793 is connected to the path sensor Type 8798 via a digital interface (see chapter [“Terminal assignment for external position sensor \(for remote variant only\)”](#) on page 51).

or



- ▲ / ▼ Select **ANALOG**.
-  Select **ENTER**.

The position signal of the external position sensor is transmitted analog

Analog interface (menu option **POS.SENSOR → ANALOG**):

Type 8793 is connected with any external position sensor with a 4 – 20 mA output signal via an interface 4 – 20 mA. To do this, the external position sensor is connected to the process actual value input (see chapter [“Terminal assignments of the process actual value input”](#) on page 52).

If the external position sensor requires an additional power supply of 24 V DC, it can be supplied via the positioner.

-  Select **EXIT**. Acknowledgment and simultaneous return to the main menu (MAIN).
-  Select **EXIT**. Switching from setting level ⇔ process level.

 A device restart will be required after a change.









- ✓ You have set the remote position sensor interface.

Tangent correction









When attaching the positioner according to NAMUR to a linear actuator, the linear position of the actuator is converted into a rotated position measured by the positioner.

This results in a non-linear correlation ($POS \sim \tan(\alpha)$) that is corrected by the tangent correction.

Setting the tangent correction:

-  Press **MENU** for 3 s. Switching from process level \Rightarrow setting level.
-  Select *POS.SENSOR*. (To do this, the auxiliary function must be incorporated into the main menu).
-  Select **ENTER**. The submenu options are displayed.
-  Select *TAN.CORRECTION*.
-  Select **ENTER**.
-  Select *tan.corr on*.
-  Select **ENTER**.
-  Select **EXIT**.
-  Select **EXIT**. Switching from setting level \Rightarrow process level.
- ✔ You have set the tangent correction.

Set the angle used by the position sensor as follows:

-  Press **MENU** for 3 s. Switching from process level \Rightarrow setting level.
-  Select *POS.SENSOR*. (To do this, the auxiliary function must be incorporated into the main menu).
-  Select **ENTER**. The submenu options are displayed.
-  Select *ALPHA*.
-  Select **ENTER**.
-  Select angle.
Example: angle used $60^\circ \Rightarrow \alpha = +/- 30^\circ$
-  Select **ENTER**.
-  Select **EXIT**.
-  Select **EXIT**. Switching from setting level \Rightarrow process level.
- ✔ You have set the angle used by the position sensor.

16.1.22 SERVICE

This function is of no importance to the operator of Type 8792/8793. It is for internal use only.

16.1.23 SIMULATION – Menu for simulation of set-point value, process and process valve

This function can be used to simulate set-point value, process and process valve independently of each other.





Note! Restarting the device deactivates the simulation.
The settings of *SIGNAL.form*, *x.SIM* and *p.SIM* are reset to the factory setting.

16.1.23.1. *SIGNAL.sim* – Simulation of the set-point value

The settings to simulate the set-point value are made in the *SIGNAL.sim* menu.

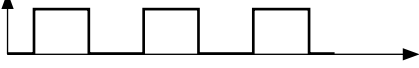
Activation of the simulation: In the *SIGNAL.form* submenu by selecting one of the following waveforms

<i>Sine</i>	Sine wave	
<i>Square</i>	Square wave	
<i>Triangle</i>	Triangle wave	
<i>Mixed</i>	Single cycle of an alternating signal sequence. Then the selection is set to <i>External</i> (set-point value simulation inactive).	

The following parameters can be set for the selected waveform.





Menu option	Parameter setting	Schematic representation with sine wave
<i>Offset</i>	(Zero offset as %)	
<i>Amplitude</i>	(Amplitude as %)	
<i>Period</i>	(Cycle duration in s)	

Table 37: *SIGNAL.sim*; parameter settings for set-point value simulation

Deactivation of the simulation: In the *SIGNAL.form* submenu

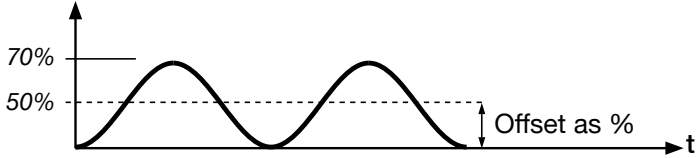
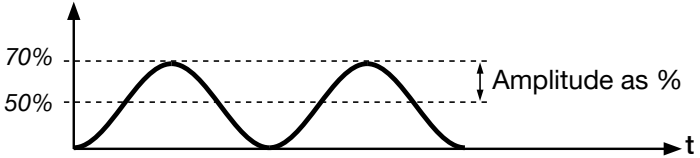
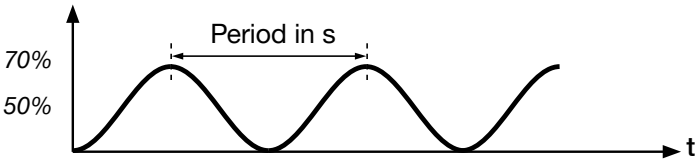

Selection *Extern* = set-point value simulation inactive
 (corresponds to the factory setting in the as-delivered state)

Activate and parameterize the set-point value simulation as follows:







-  Press **MENU** for 3 s. Switching from process level ⇒ setting level.
- ▲ / ▼ Select *SIMULATION*. (To do this, the auxiliary function must be incorporated into the main menu).
-  Select **ENTER**. The submenu for setting the simulation is displayed.
- ▲ / ▼ Select *SIGNAL.sim*.
-  Select **ENTER**.
The submenu for activating and parameterizing the set-point value simulation is displayed.
- ▲ / ▼ Select *required menu option*

Selection *Extern* = simulation inactive.

Selection *Sine* / *Square* / *Triangle* / *Mixed* = specify the waveform as well as activation of the simulation.

-  Select **SELEC**. The selection is marked by a filled circle ●.
-  Select **EXIT**. Return to the *SIGNAL.sim* menu.

Setting the parameters for simulation of the set-point value:

- ▲ / ▼ Select *offset* (zero offset as%).
-  Select **INPUT**. The input screen for specifying the offset is opened.
- ▲ / ▼ Increase value
 Select decimal place and enter value.
-  Select **OK**. Transfer and simultaneous return to the *SIGNAL.sim* menu.
- ▲ / ▼ Select *amplitude* (amplitude as%).
-  Select **INPUT**. The input screen for specifying the amplitude is opened.
- ▲ / ▼ Increase value
 Select decimal place and enter value.
-  Select **OK**. Transfer and simultaneous return to the *SIGNAL.sim* menu.
- ▲ / ▼ Select *period* (period duration in seconds).
-  Select **INPUT**. The input screen for specifying the cycle duration is opened.
- ▲ / ▼ Increase value
 Select decimal place and enter value.
-  Select **OK**. Transfer and simultaneous return to the *SIGNAL.sim* menu.
-  Select **EXIT**. Return to the *SIMULATION* menu.

For simulation of process and process valve:

→ ▲ / ▼ Select *CONTROL.sim*.

For description see chapter “16.1.23.2. *CONTROL.sim* – Simulation of the process and process valve”.

Leaving the *SIMULATION* menu:

→  Select **EXIT**. Return to the main menu (MAIN).

→  Select **EXIT**. Switching from setting level ⇒ process level.

✔ You have activated and parameterized the set-point value simulation.

16.1.23.2. *CONTROL.sim* – Simulation of the process and process valve

The settings to simulate the process and the process valve are made in the *CONTROL.sim* menu.

Settings

Type of simulation: Simulation of the process valve.

Simulation of the process.

Parameterization of the process: Specify amplification factor.

Specify time constant in seconds.

Example of a simulated process:

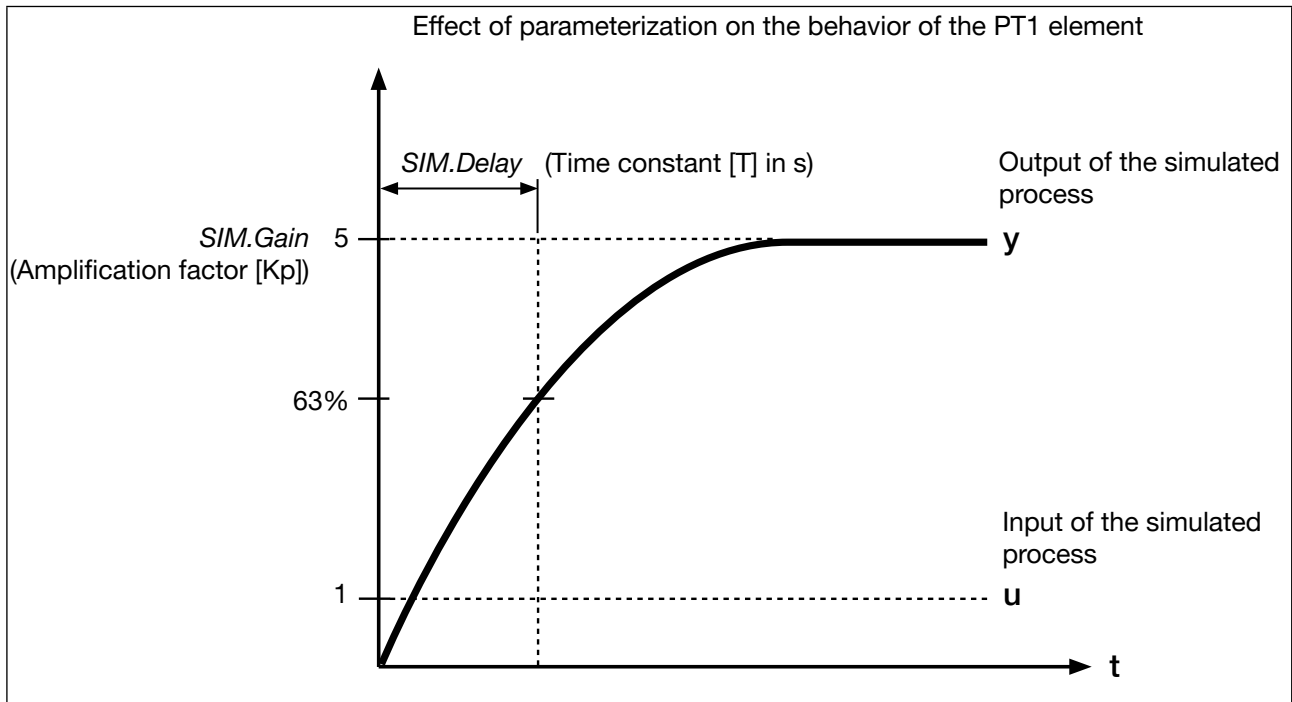





Figure 43: Example of a simulated process. Behavior of the PT1 element

Simulate the processes and process valve as follows:







-  Press **MENU** for 3 s. Switching from process level ⇒ setting level.
- ▲ / ▼ Select **SIMULATION**. (To do this, the auxiliary function must be incorporated into the main menu).
-  Select **ENTER**. The submenu for setting the simulation is displayed.
- ▲ / ▼ Select **CONTROL.sim**.
-  Select **ENTER**.
The submenu for activating and parameterizing the process and process valve simulation is displayed.
- ▲ / ▼ Select required simulation.

Selection = simulation process.

Selection = simulation process valve.

-  Select **SELEC**. Activate the selection by checking the box or deactivate it by unchecking the box .

Setting the parameters for simulation of the process and/or the process valve:

- ▲ / ▼ Select **SIM.Gain**. (Amplification factor).
-  Select **INPUT**. The input screen for specifying the amplification factor is opened.
- ▲ / ▼ Increase value
 Select decimal place and enter value.
-  Select **OK**. Transfer and simultaneous return to the **CONTROL.sim** menu.
- ▲ / ▼ Select **SIM.Delay** (period duration in seconds).
-  Select **INPUT**. The input screen for specifying the cycle duration is opened.
- ▲ / ▼ Increase value
 Select decimal place and enter value.
-  Select **OK**. Transfer and simultaneous return to the **CONTROL.sim** menu.
-  Select **EXIT**. Return to the **SIMULATION** menu.
-  Select **EXIT**. Return to the main menu (MAIN).
-  Select **EXIT**. Switching from setting level ⇒ process level.
- ✔ You have simulated the process and process valve.

16.1.24 DIAGNOSE – Menu for monitoring valves (option)

The optional function *DIAGNOSE* can be used to monitor the state of the valve. If there are deviations from the set-point state, messages are output according to NE 107.

Example of the output of a diagnostic message:

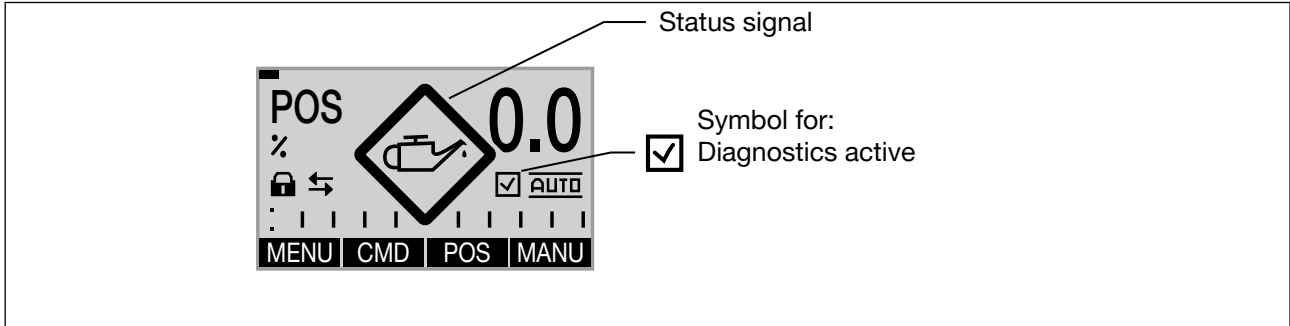

Figure 44: Example of a diagnostic message

16.1.24.1. Activation of the *DIAGNOSE* menu

To ensure that the *DIAGNOSE* menu can be set, it must first be activated in the main menu of the setting level (MAIN) via *ADD.FUNCTION*. See chapter “16.1 Activating and deactivating auxiliary functions”.

! The active diagnostics is indicated on the display of the process level with a check mark symbol . See “Figure 44”

16.1.24.2. The *DIAGNOSE* main menu

The *DIAGNOSE* main menu consists of the following submenus.

	D.MSG	(Diagnostic messages) list of all diagnostic messages.
	CONFIG.MSG	Assignment of status signals for different diagnostic messages according to NE 107 (NE = NAMUR recommendation).
	ADD.DIAGNOSE	Activation of diagnostic functions by incorporation into the <i>DIAGNOSE</i> main menu.
	RESET.HISTORY	Deletion of the history entries of all diagnostic functions. The menu is only displayed if the <i>CLOCK</i> function has been selected on the process level.

Table 38: *DIAGNOSE*; main menu

16.1.24.3. Activation of diagnostic functions

In the *ADD.DIAGNOSE* menu several diagnostic functions are activated and incorporated into the *DIAGNOSE* main menu.

Activatable diagnostic functions:





HISTOGRAM	Graphical display of the dwell time density and movement range.
SERVICE.TIME	Operating-hours counter
TRAVEL.ACCU	Path accumulator
CYCLE.COUNTER	Direction reversal counter
TEMP.CHECK	Temperature monitor
STROKE.CHECK	Monitoring of the mechanical end positions in the valve
PV.MONITOR	Process actual value monitoring (for Type 8793 only, process control)
POS.MONITOR	Position monitoring

Table 39: *ADD.DIAGNOSE*; overview of diagnostic functions

The description can be found in chapter “16.1.24.4. Description of the *DIAGNOSE* main menu”.

In the *ADD.DIAGNOSE* menu several diagnostic functions are activated and incorporated into the *DIAGNOSE* main menu.

Activate the diagnostic functions as follows:

-  Press **MENU** for 3 s. Switching from process level ⇒ setting level.
- ▲ / ▼ Select *DIAGNOSE*. (To do this, the *DIAGNOSE* auxiliary function must already have been activated by incorporation into the main menu (MAIN)).
-  Select **ENTER**. The submenus are displayed.
- ▲ / ▼ Select *ADD.DIAGNOSE*.
-  Select **ENTER**.
The other diagnostic functions are displayed.
- ▲ / ▼ Select required diagnostic function
-  Select **ENTER**. The required diagnostic function is now marked by a cross ☒.

Either:

- ▲ / ▼ Select other diagnostic functions and select  **ENTER**.
Keep repeating until all required diagnostic functions have been marked with a cross ☒.

Or:

-  Select **EXIT**.
Acknowledgment and simultaneous return to the *DIAGNOSE* main menu.
The marked diagnostic functions have been activated and the setting menus are now in the *DIAGNOSE* main menu.

✔ You have activated the diagnostic functions.

16.1.24.4. Description of the *DIAGNOSE* main menu

1. **D.MSG** – Diagnostic messages

All generated diagnostic messages are listed in the D.MSG menu where they can be viewed and deleted. The status signal, which is assigned to the diagnostic message, is indicated by a symbol.

Display example of a list with diagnostic messages

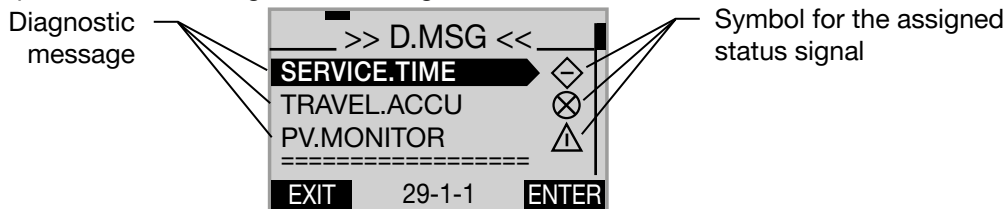

Display example of the description text of a diagnostic message

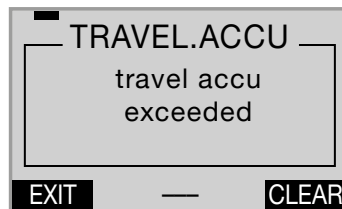

View and delete diagnostic messages as follows:

- ▲ / ▼ Select *D.MSG*.
- Select **ENTER**. All generated diagnostic messages are displayed.
- ▲ / ▼ Select required message
- Select **ENTER**.
Opening the diagnostic message. The description text is displayed (in English).
- Select **EXIT**.
Closing the diagnostic message and return to *D.MSG*.

Or:

- Select **CLEAR**. Hold down as long as countdown (5 ...) is running.
Deleting the diagnostic message and return to *D.MSG*.
- Select **EXIT**.
Return to the *DIAGNOSE* main menu.

✔ You have viewed and deleted the diagnostic functions.

2. **CONFIG.MSG** – Assignment of status signals according to NE 107 (NAMUR recommendation)

The status signals of the diagnostic messages can be changed in the CONFIG.MSG menu.

The menu indicates only diagnostic functions which can output a message and which have already been activated in the *ADD.DIAGNOSE* menu.

The status signals have different priorities.

If several diagnostic messages are available with different status signals, the status signal with the highest priority is shown on the display.

Overview of the status signals according to NE 107 (NE = NAMUR recommendation):

Priority	1	2	3	4
Status signal				
Meaning	Failure	Function check	Out of specification	Maintenance required

Table 40: CONFIG.MSG; overview of status signals

The following status signals have been preset at the factory for the messages of the diagnostic functions:

Diagnostic function	Status signal according to NE 107	Signal miniature	Priority
SERVICE.TIME	Maintenance required		4
TRAVEL.ACCU	Maintenance required		4
CYCLE.COUNTER	Maintenance required		4
TEMP.CHECK	Out of specification		3
STROKE.CHECK	Out of specification		3
PV.MONITOR	Out of specification		3
POS.MONITOR	Out of specification		3

Table 41: CONFIG.MSG; factory setting (Default)

Assign the status signals as follows:

- ▲ / ▼ Select CONFIG.MSG.
- Select ENTER. All activated diagnostic functions, which can output a message, are displayed.
- ▲ / ▼ Select required message.
- Select ENTER.
The list of possible status signals is displayed.
- ▲ / ▼ Select required message.
- Select SELEC.
The selected status signal is now marked by a filled circle ●.
- Select EXIT. Acknowledgment and simultaneous return to the CONFIG.MSG menu.
The status signal is now assigned to the diagnostic function.
- Select EXIT. Return to the DIAGNOSE main menu.
- ✔ You have assigned the status signals.

3. **ADD.DIAGNOSE** – Activation and deactivation of diagnostic functions

Diagnostic functions can be activated in this menu and incorporated into the *DIAGNOSE* main menu or already activated diagnostic functions can be deactivated again.

Activation of diagnostic functions:

For a description see chapter "[16.1.24.3. Activation of diagnostic functions](#)"

Deactivation of diagnostic functions:

The procedure is the same as for activation. Except that with deactivation the cross after the diagnostic function is removed again by pressing the **ENTER** key.

4. **RESET.HISTORY** – Deletion of the history entries of all diagnostic functions

Explanation of the history entries:

There is a history entry for each diagnostic message. This entry is assigned to the diagnostic function, which has actuated this message, and is saved there in the *HISTORY* submenu.





In the menu of some diagnostic functions there is a *HISTORY* submenu in which the history entries are saved.

RESET.HISTORY is used to delete the entries of all *HISTORY* submenus.

Individual entries can be deleted in the *HISTORY* submenu of the particular diagnostic function.

See also chapter "[16.1.24.6. History entries in the HISTORY submenu](#)".

Delete all history entries as follows:

- ▲ / ▼ Select *RESET.HISTORY*.
-  Select **RUN** as long as countdown (5 ...) is running.
All history entries are deleted.
-  Select **EXIT**. Return to the *DIAGNOSE* main menu.

✔ You have deleted the history entries.



History entries are only created when the *CLOCK* function for the display has been activated on the process level.

For activation and setting of *CLOCK* see chapter "[13.4.1 Setting date and time](#)"

16.1.24.5. Description of the diagnostic functions

HISTOGRAM – Output of histograms

The *HISTOGRAM* menu is divided into 2 parts:

1. **Outputting the histograms for**
POS-Class (dwell time density) and
DIR-Class (movement range)
2. **List of the characteristic values for**
 CMD Set-point position valve actuator
 POS Actual position valve actuator
 DEV Deviation from POS to CMD
 TEMP Temperature
 SP Process set-point value
 PV Process actual value

Display description of the histograms:

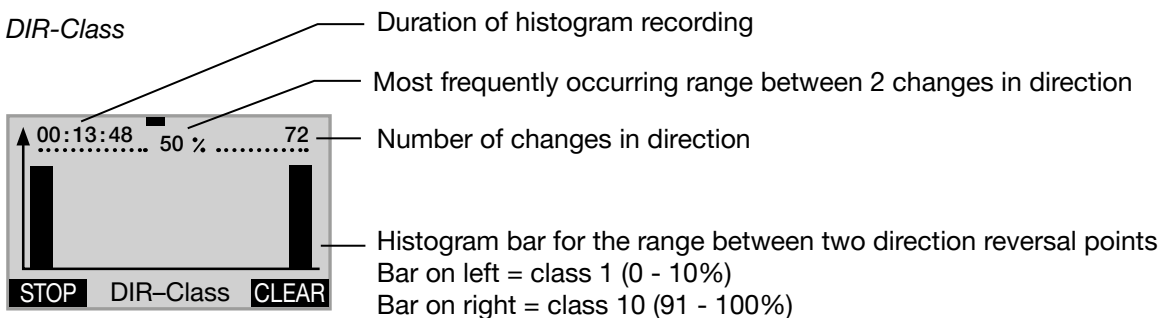
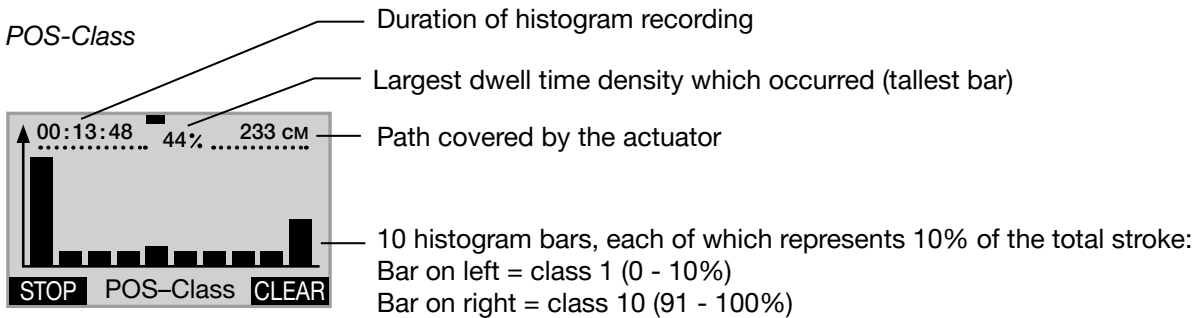

POS-Class - Description of the histogram of the dwell time density

The histogram indicates how long the actuator has stopped in a specific position.

For this purpose the stroke range is divided into 10 classes.

The current position of one of the 10 classes is assigned to each scan time.

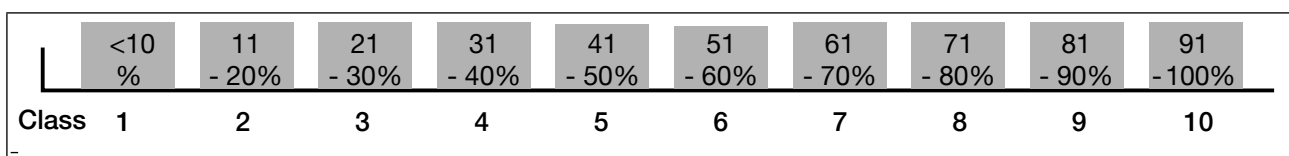

Figure 45: *CMD-Class; position classes*

Explanation of the histogram in the example

Sinusoidal progression of the actuator position:

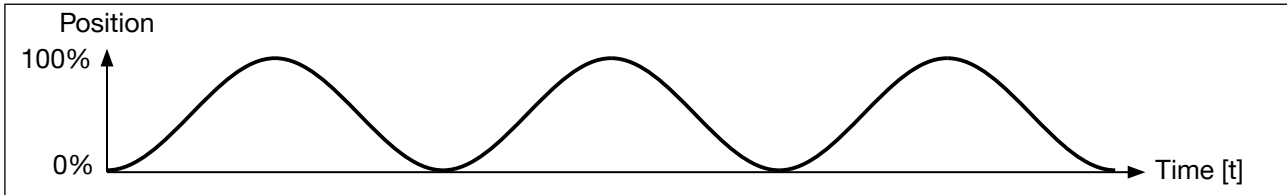

Figure 46: Sinusoidal progression of the actuator position

Histogram of the sinusoidal progression of the actuator position:

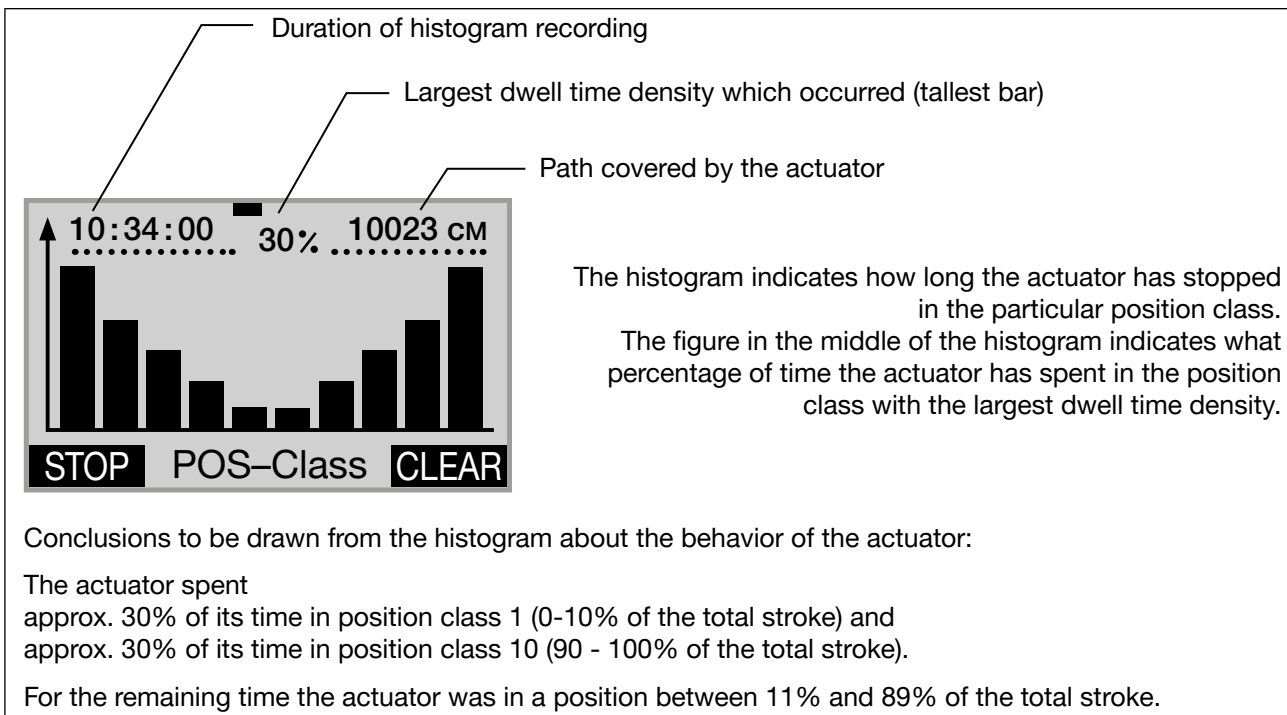

Figure 47: POS-Class; histogram of the dwell time density for sinusoidal progression of the actuator position

! The distribution of the histogram allows conclusions to be drawn about the design of the control valve. For example, if the actuator is in the lower stroke range only, the valve has probably been designed too large.

DIR-Class - Description of the histogram of the movement range

The histogram indicates the movement ranges of the actuator between two direction reversal points.

For this purpose the movement range between two changes in direction is divided into 10 classes. The current position of one of the 10 classes is assigned to each scan time.

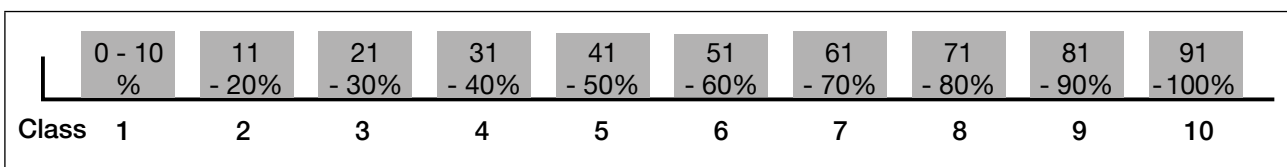

Figure 48: DIR-Class; change in direction classes

MAN 1000341264 EN Version: F Status: RL (released | freigegeben) printed: 01.09.2023

Explanation of the histogram in the example

Sinusoidal progression of the actuator position:

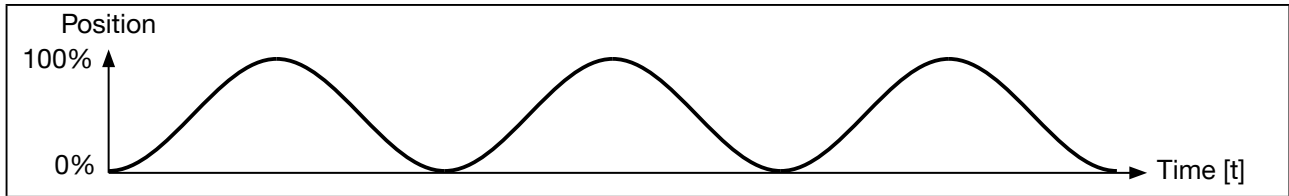

Figure 49: Sinusoidal progression of the actuator position

Histogram of the sinusoidal progression of the actuator position:

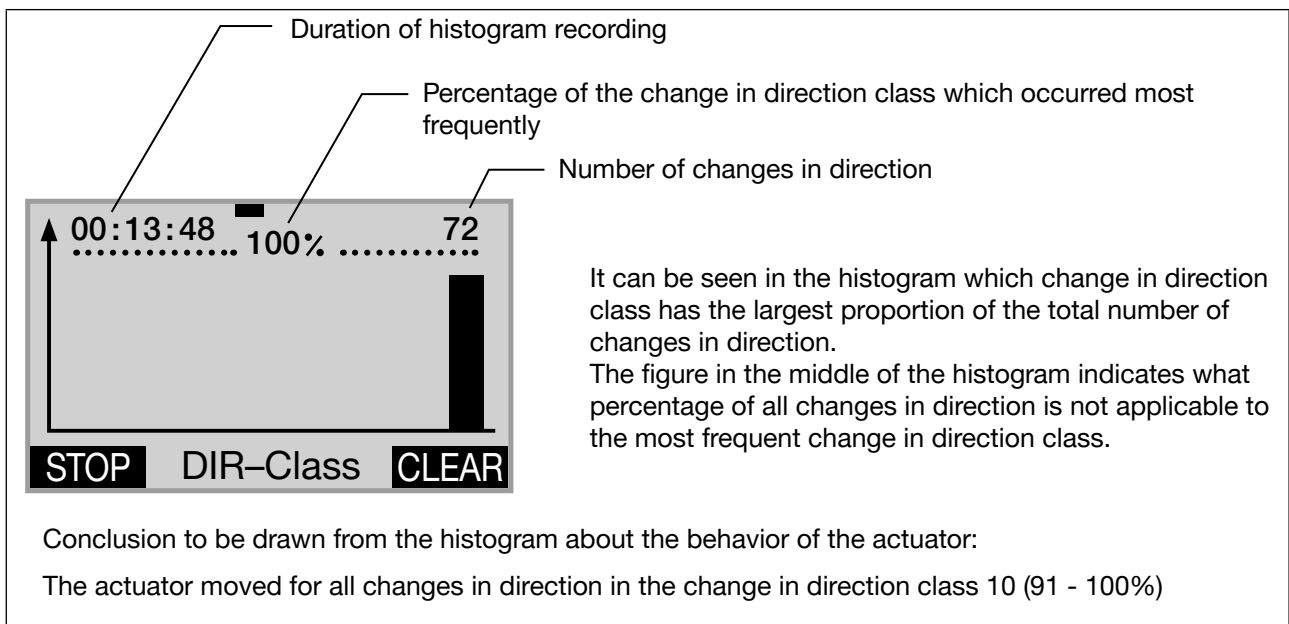

Figure 50: DIR-Class; histogram of the dwell time density for sinusoidal progression of the actuator position

! The histograms will only give correct information about the behavior of the actuator when the *X.TUNE* function required for the basic setting has been run.



Start, stop and delete the histograms as follows:

- ▲ / ▼ Select **HISTOGRAM**.
(To do this, the *HISTOGRAM* function must be incorporated into the *DIAGNOSE* main menu. See chapter "16.1.24.3. Activation of diagnostic functions").
- 🗑️ Select **ENTER**. The empty matrix of the POS-Class submenu (dwell time density) is displayed.



MAN 1000341264 EN Version: F Status: RL (released | freigegeben) printed: 01.09.2023

Starting histograms:

Note: Diagnostics data are not saved persistently and will be lost when restarting the device.

-  Select **START** *. Hold down as long as countdown (5 ...) is running.
Both histograms (*POS-Class* and *DIR-Class*) are started.
-  Change display view.
Selection options:
POS-Class (Histogram for the dwell time density),
DIR-Class (Histogram for the movement range),
SYSTEM-DATA (list of the characteristic values).



Stopping histograms:

-  Select **STOP** *. Hold down as long as countdown (5 ...) is running.
The recording of both histograms (*POS-Class* and *DIR-Class*) is stopped.
-  Change display view.
Selection options:
POS-Class (Histogram for the dwell time density),
DIR-Class (Histogram for the movement range),
SYSTEM-DATA (list of the characteristic values).

Deleting histograms:

-  Select **CLEAR** *. Hold down as long as countdown (5 ...) is running.
Both histograms (*POS-Class* and *DIR-Class*) are deleted.

Return to the *DIAGNOSE* main menu:

-  Select *SYSTEM-DATA*
-  or  Select **EXIT**. Return to the *DIAGNOSE* main menu.

* The key functions **START**, **STOP** and **CLEAR** are available only in the display views of the histograms *POS-Class* and *DIR-Class*.

- ✔ You have started, stopped and deleted the histograms.

SERVICE.TIME – Operating-hours counter

The operating-hours counter records the time during which the device was switched on.

If the duty cycle reaches the specified time limit, a message is generated.

- To do this, a history entry is made in the *HISTORY* submenu. For a description see [“16.1.24.6. History entries in the HISTORY submenu”](#).
- The status signal, which is assigned to the message, is indicated at short intervals on the display. See also *D.MSG* and *CONFIG.MSG* in chapter [“16.1.24.4”](#) on page 128.





Display <i>SERVICE.TIME</i>	Description of the functions
	<p>The interval for messages preset at the factory for 90 days can be changed in the <i>LIMIT</i> submenu.</p> <p>After <i>NEXT.M</i> the remaining time is displayed until the next message appears.</p> <p>The history entries of the last 3 messages can be viewed and deleted in the <i>HISTORY</i> submenu.</p>

Table 42: *SERVICE.TIME*; operating-hours counter

Specify the interval for outputting messages as follows:

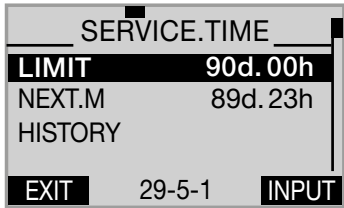
- ▲ / ▼ Select *SERVICE.TIME*.
(To do this, the *SERVICE.TIME* function must be incorporated into the *DIAGNOSE* main menu. See chapter [“16.1.24.3. Activation of diagnostic functions”](#)).
-  Select **ENTER**. The menu is displayed.
- ▲ / ▼ Select *LIMIT*.
-  Select **INPUT**. The preset value is displayed.
- ▲ / ▼ **+** Increase value
<- Changing the (time unit: d/h/m)
Setting interval for outputting the message.
-  Select **OK**. Return to the *SERVICE.TIME* menu.
-  Select **EXIT**. Return to the *DIAGNOSE* main menu.
- ✔ You have specified the interval for outputting messages.

TRAVEL.ACCU – Path accumulator

The path accumulator records and adds up the path which the actuator piston covers. A movement of the actuator piston is detected when the position changes by at least 1%.

The interval for outputting messages is specified by inputting a limit for the total number of piston movements.

- To do this, a history entry is made in the *HISTORY* submenu. For a description see [“16.1.24.6. History entries in the HISTORY submenu”](#).
- The status signal, which is assigned to the message, is indicated at short intervals on the display. See also *D.MSG* and *CONFIG.MSG* in chapter [“16.1.24.4”](#) on page 128.







Display <i>TRAVEL.ACCU</i>	Description of the functions
 <p>The screenshot shows the <i>TRAVEL.ACCU</i> menu with the following options: HUB (20.0 mm), LIMIT (1000000 cm), NEXT.M (999954 cm), HISTORY, and EXIT (29-6-1). The INPUT key is highlighted at the bottom right.</p>	<p>The <i>HUB</i> submenu specifies the total stroke of the actuator piston. The total stroke is automatically determined during the basic setting of the device (running <i>X.TUNE</i>).</p> <p>In the case of an analog position sensor, the total stroke must be entered by pressing the INPUT key.</p> <p>The interval for outputting the message can be changed in the <i>LIMIT</i> submenu. A piston movement which covers 10 km has been preset at the factory.</p> <p>After <i>NEXT.M</i> the remaining piston movement distance is displayed until the next message appears.</p> <p>The history entries of the last 3 messages can be viewed and deleted in the <i>HISTORY</i> submenu.</p>

Table 43: *TRAVEL.ACCU*; path accumulator

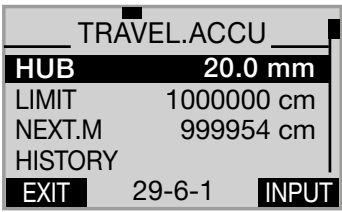
Specify the interval for outputting messages as follows:

- ▲ / ▼ Select *TRAVEL.ACCU*.
(To do this, the *TRAVEL.ACCU* function must be incorporated into the *DIAGNOSE* main menu. See chapter “16.1.24.3. Activation of diagnostic functions”).
-  Select **ENTER**. The menu is displayed.
- * Required for analog position sensor only (setting the *HUB* submenu)
- ▲ / ▼ Select *HUB*.
-  Select **INPUT** *. The preset value is displayed.
- ▲ / ▼ **+** Increase value
<- Changing the decimal place
Setting total stroke of the actuator piston.
- ▲ / ▼ Select *LIMIT*.
-  Select **INPUT** *. The preset value is displayed.
- ▲ / ▼ **+** Increase value
<- Changing the decimal place
Setting interval for outputting the message (limit for sum of the piston movement).
-  Select **OK**. Return to the *TRAVEL.ACCU* menu.
-  Select **EXIT**. Return to the *DIAGNOSE* main menu.
- ✔ You have specified the interval for outputting messages.

CYCLE.COUNTER – Direction reversal counter

The direction reversal counter counts the number of changes in direction of the actuator piston. A change in direction is detected when the position of the actuator piston changes by at least 1%.

The interval for outputting messages is specified by inputting a limit for the total number of changes in direction.

- To do this, a history entry is made in the *HISTORY* submenu. For a description see [“16.1.24.6. History entries in the HISTORY submenu”](#).
- The status signal, which is assigned to the message, is indicated at short intervals on the display. See also *D.MSG* and *CONFIG.MSG* in chapter [“16.1.24.4”](#) on page 128.





Display <i>CYCLE.COUNTER</i>	Description of the functions
	<p>The interval for outputting the message can be changed in the <i>LIMIT</i> submenu. 1 million changes in direction have been preset at the factory.</p> <p>After <i>NEXT.M</i> the remaining changes in direction are displayed until the next message appears.</p> <p>The history entries of the last 3 messages can be viewed and deleted in the <i>HISTORY</i> submenu.</p>

Table 44: *SERVICE.TIME*; operating-hours counter

Specify the interval for outputting messages as follows:

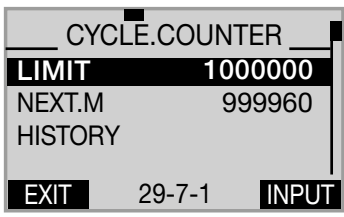
- ▲ / ▼ Select *CYCLE.COUNTER*.
(To do this, the *CYCLE.COUNTER* function must be incorporated into the *DIAGNOSE* main menu. See chapter [“16.1.24.3. Activation of diagnostic functions”](#).)
-  Select **ENTER**. The menu is displayed.
- ▲ / ▼ Select *LIMIT*.
-  Select **INPUT**. The preset value is displayed.
- ▲ / ▼ **+** Increase value
<- Changing the decimal place
Setting interval for outputting the message (limited number of changes in direction).
-  Select **OK**. Return to the *CYCLE.COUNTER* menu.
-  Select **EXIT**. Return to the *DIAGNOSE* main menu.
- ✓ You have specified the interval for outputting messages.

TEMP.CHECK – Temperature monitor

The temperature monitor checks whether the current temperature * is within the specified temperature range. The temperature range is specified by inputting a minimum and maximum temperature. If the temperature deviates from the specified range, a message is output.

- To do this, a history entry is made in the *HISTORY* submenu. For a description see [“16.1.24.6. History entries in the HISTORY submenu”](#).
- The status signal, which is assigned to the message, is indicated at short intervals on the display. See also *D.MSG* and *CONFIG.MSG* in chapter [“16.1.24.4”](#) on page 128.

In addition to the monitor there is a temperature slave pointer. This indicates the lowest and highest of the measured temperature values. The slave pointer can be reset by pressing the **CLEAR** key.











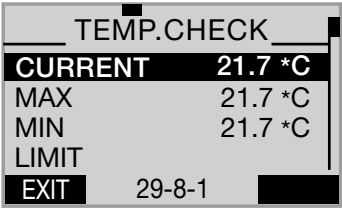
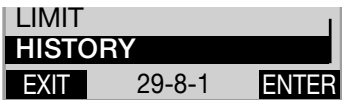

Display <i>TEMP.CHECK</i>	Description of the functions
 	<p><i>CURRENT</i> indicates the current temperature *.</p> <p><i>MAX</i> indicates the highest temperature of the slave pointer.</p> <p><i>MIN</i> indicates the lowest temperature of the slave pointer.</p> <p>The permitted temperature range can be changed in the <i>LIMIT</i> submenu. A message is output if the temperature goes outside the permitted range. The temperature range has been preset at the factory from 0 – 60 °C.</p> <p>The history entries of the last 3 messages can be viewed and deleted in the <i>HISTORY</i> submenu.</p>

Table 45: *TEMP.CHECK*; temperature range

*When selecting *LIMIT* values, make sure that the temperature displayed is influenced by the heating of the electronics assembly and by the heat radiation of hot valve components.
This must not be interpreted as an ambient temperature.
Similar temperature values must therefore only be expected for comparable usage conditions.

Specify the temperature limit for outputting messages as follows:

- ▲ / ▼ Select *TEMP.CHECK*.
(To do this, the *TEMP.CHECK* function must be incorporated into the *DIAGNOSE* main menu. See chapter “16.1.24.3. Activation of diagnostic functions”).
 -  Select **ENTER**. The menu is displayed.
 - ▲ / ▼ Select *LIMIT*.
 -  Select **ENTER**.
The upper and lower temperature limit is displayed.
The upper limit *TEMP.MAX* has already been selected.
 -  Select **INPUT**. Open input screen for upper temperature limit.
 - ▲ / ▼  Increase value
 Changing the decimal place
Enter upper temperature limit *TEMP.MAX*.
 -  Select **OK**. Acknowledge value.
 - ▲ / ▼ Select *TEMP.MIN*.
 -  Select **INPUT**. Open factory setting for lower temperature limit.
 - ▲ / ▼  Increase value
 Changing the decimal place
Enter lower temperature limit *TEMP.MIN*.
 -  Select **OK**. Acknowledge value.
 -  Select **EXIT**. Return to the *TEMP.CHECK* menu.
 -  Select **EXIT**. Return to the *DIAGNOSE* main menu.
- ✔ You have specified the temperature limit for outputting messages.

STROKE.CHECK – End position monitor

The *STROKE.CHECK* function is used to monitor the physical end positions of the valve. In this way wear marks can be detected on the valve seat.

To do this, a tolerance band is specified for the lower end position (position 0%) and for the upper end position (position 100%). If an end position exceeds or falls below the tolerance band, a message is output.

- To do this, a history entry is made in the *HISTORY* submenu. For a description see “[16.1.24.6. History entries in the HISTORY submenu](#)”.
- The status signal, which is assigned to the message, is indicated at short intervals on the display. See also *D.MSG* and *CONFIG.MSG* in chapter “[16.1.24.4](#)” on page 128.

In addition to the monitor there is an end position slave pointer. This indicates the minimum and maximum position of the determined end positions. The slave pointer can be reset by pressing the **CLEAR** key.

Display <i>STROKE.CHECK</i>	Description of the functions
	<p><i>MAX</i> indicates the maximum position of the slave pointer</p> <p><i>MIN</i> indicates the minimum position of the slave pointer.</p> <p>The tolerance band for the physical end positions can be set in the <i>LIMIT</i> submenu. A message is output if the temperature goes outside the permitted range.</p> <p>Example: Input upper end position <i>TOL MAX</i> = 1% If the position is less than -1%, a message is output</p> <p>Input lower end position <i>TOL ZERO</i> = 1% If the position is greater than 101%, a message is output</p> <p>The history entries of the last 3 messages can be viewed and deleted in the <i>HISTORY</i> submenu.</p>

Table 46: *STROKE.CHECK*; end position monitor





If a stroke limit was set in the *X.LIMIT* menu, the mechanical end position monitor has only limited relevance.

The end positions indicated on the process level under *POS* are not the physically caused end positions in this case. Therefore they cannot be compared with the end positions indicated in the *STROKE.CHECK* menu under *MIN* and *MAX*.

Specify the Position limit for outputting messages as follows:

- Select *STROKE.CHECK*.
(To do this, the *STROKE.CHECK* function must be incorporated into the *DIAGNOSE* main menu. See chapter “[16.1.24.3. Activation of diagnostic functions](#)”).
- Select **ENTER**. The menus are displayed.
- Select *LIMIT*.
- Select **ENTER**.
The submenus for inputting the lower and upper end position tolerance are displayed.
The submenu for inputting the lower end position tolerance *ZERO.TOL* has already been selected.
- Select **INPUT**. Open input screen for lower end position tolerance.

MAN 1000341264 EN Version: F Status: RL (released | freigegeben) printed: 01.09.2023

- ▲ / ▼ **+** Increase value
 <- Changing the decimal place
 Enter lower end position tolerance *ZERO.TOL*.
-  Select **OK**. Acknowledge value.
- ▲ / ▼ Select *MAX.TOL*.
-  Select **INPUT**. Open input screen for lower end position tolerance.
- ▲ / ▼ **+** Increase value
 <- Changing the decimal place
 Enter upper end position tolerance *MAX.TOL*.
-  Select **OK**. Acknowledge value.
-  Select **EXIT**. Return to the *STROKE.CHECK* menu.
-  Select **EXIT**. Return to the *DIAGNOSE* main menu.
- ✔ You have specified the position limit for outputting messages.

POS.MONITOR –Position monitoring

The *POS.MONITOR* function monitors the current position of the actuator.

The tolerance band for the set-point value is specified in the *DEADBAND* submenu.

A period for alignment of the actual value with the set-point value is specified in the *COMP.TIME* submenu (compensation time).

The compensation time *COMP.TIME* starts recording as soon as the set-point value is constant. When the compensation time has elapsed, monitoring starts.

If the control deviation (DEV) of the actual value is greater than the tolerance band of the set-point value during monitoring, a message is output.

- To do this, a history entry is made in the *HISTORY* submenu. For a description see [“16.1.24.6. History entries in the HISTORY submenu”](#).
- The status signal, which is assigned to the message, is indicated at short intervals on the display. See also *D.MSG* and *CONFIG.MSG* in chapter [“16.1.24.4”](#) on page 128.

Display <i>POS.MONITOR</i>	Description of the functions
	<p>The tolerance band of the set-point value preset at the factory to 2% can be changed in the <i>DEADBAND</i> submenu.</p> <p>The compensation time is set in <i>COMP.TIME</i> (compensation time).</p> <p>The history entries of the last 3 messages can be viewed and deleted in the <i>HISTORY</i> submenu.</p>

Table 47: *POS.MONITOR*; position monitor

Schematic representation

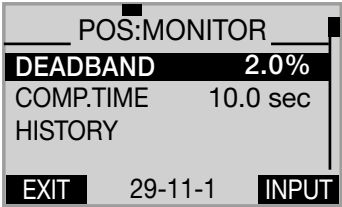
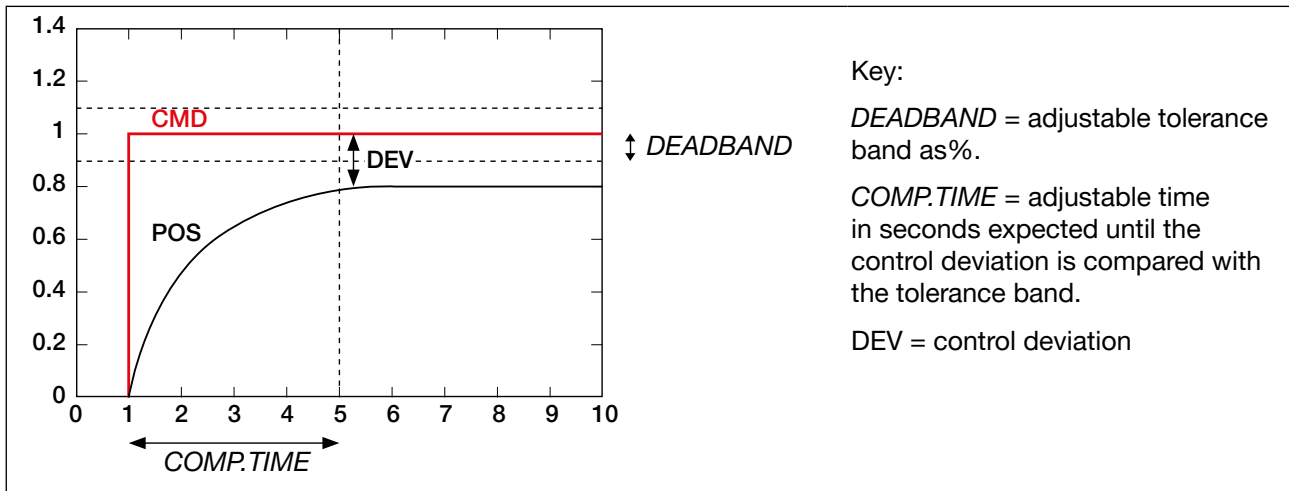

Figure 51: POS.MONITOR; schematic representation of position monitor

Set the tolerance band and the compensation time as follows:

- ▲ / ▼ Select **POS.MONITOR**.
(To do this, the **POS.MONITOR** function must be incorporated into the **DIAGNOSE** main menu. See chapter “16.1.24.3. Activation of diagnostic functions”).
- Select **ENTER**. The menu is displayed. **DEADBAND** has already been selected.
- Select **INPUT**. The preset value is displayed.
- ▲ / ▼ **+** Increase value
 <- Changing the decimal place
 Enter tolerance band.
- Select **OK**. Acknowledge value.
- ▲ / ▼ Select **COMP.TIME**.
- Select **INPUT**. The preset value is displayed.
- ▲ / ▼ **+** Increase value
 <- Changing the decimal place
 Enter compensation time.
- Select **OK**. Return to the **POS.MONITOR** menu.
- Select **EXIT**. Return to the **DIAGNOSE** main menu.
- ✔ You have specified the tolerance band and the compensation time.

PV.MONITOR – Process monitor (for Type 8793 only)

The **PV.MONITOR** function monitors the process actual value.

The operating menu is identical to the position monitor **POS.MONITOR** described above. In contrast, it is not the position of the actuator which is monitored here but the process.

16.1.24.6. History entries in the *HISTORY* submenu

Each diagnostic function, which can output a message, has the *HISTORY* submenu.

When the diagnostic message is actuated, a history entry is created with date and value. The history entries of the respective diagnostic function can be viewed and deleted in the *HISTORY* submenu.

A maximum of three history entries are stored from each diagnostic message. If three history entries are already available when a message is actuated, the oldest history entry is deleted.

Example: History of the diagnostic function *TRAVEL.ACCU*

TRAVEL.ACCU	
DATE	VALUE
01.02.12	5 cm
01.02.12	35 cm
01.02.12	10 cm
EXIT	CLEAR

Description:

On the left of the display is the date and on the right the associated value.

Deleting the history:

Hold down the **CLEAR** key until the countdown (5...) is running.



The *RESET.HISTORY* diagnostic menu can be used to jointly delete the histories of all diagnostic functions. See chapter "16.1.24.4" on page 128.

Delete the histories of a diagnostic function (example *TRAVEL.ACCU*) as follows:

- ▲ / ▼ Select *TRAVEL.ACCU*.
- Select **ENTER**. The menu is displayed.
- ▲ / ▼ Select *HISTORY*.
- Select **INPUT**. History entries with date and value are displayed.
- Select **CLEAR**. Hold down as long as countdown (5 ...) is running. The histories of the *TRAVEL.ACCU* diagnostic function are deleted.
- Select **EXIT**. Return to the *TRAVEL.ACCU* menu.
- Select **EXIT**. Return to the *DIAGNOSE* main menu.

✔ You have deleted the histories of the diagnostic function.



History entries are only created when the *CLOCK* function for the display has been activated on the process level.

To receive correct history entries, date and time must be correct.

Date and time must be reset after a restart. Therefore, the device switches immediately and automatically to the corresponding menu after a restart.

For activation and setting of *CLOCK* see chapter "13.4.1 Setting date and time"

16.2 Manual configuration of X.TUNE



This function is required for special requirements only.

For standard applications the X.TUNE function has been preset at the factory. See chapter “14.2.2 X.TUNE – Automatic adjustment of the position controller”.

For special requirements the X.TUNE function, as described below, can be manually configured.

Open the menu for the manual configuration of X.TUNE as follows:

→  Press **MENU** for 3 s. Switching from process level ⇒ setting level.

→  Select X.TUNE.

→  Select **RUN**. Opening the *Manual.TUNE* menu. The menu options for the manual configuration of X.TUNE are displayed.

✓ You have opened the menu for the manual configuration of X.TUNE.



16.2.1 Description of the menu for the manual configuration of X.TUNE

X.TUNE.CONFIG	Configuration of the X.TUNE function	Specify which functions are to be executed when X.TUNE is running (automatic self-optimization).
M.TUNE.POS	Position of the end positions	<ul style="list-style-type: none"> - Specify whether the pneumatic actuator has mechanical end positions. - Manual specification of the end positions If there are no mechanical end positions available, these are not approached by the X.TUNE and must be manually specified.
M.TUNE.PWM	Optimization of the PWM signals	Manual optimization of the PWM signals for control of the aeration valves and bleed valves. For optimization the valves must be aerated and bled. A progress bar on the display indicates the speed at which the valve is aerated or bled. The setting is optimum when the progress bar moves as slowly as possible.
M.TUNE.AIR	Determination of the opening and closing times of the actuator	Continuous determination of the opening and closing times of the actuator.

16.2.1.1. X.TUNE.CONFIG – Configuration of the X.TUNE function

In this menu you can specify which functions are to be executed when the X.TUNE function is running automatically.

Specify the functions in X.TUNE.CONFIG as follows:

- ▲ / ▼ Select X.TUNE.CONFIG.
-  Select **ENTER**. The functions for automatic self-parameterization by X.TUNE are displayed.
- ▲ / ▼ Select required function.
-  Select **SELEC**. Activate the function by checking the box .
- Select required functions in succession using the arrow keys ▲ / ▼ and activate by checking the box .
-  Select **EXIT**. Return to the *Manual.TUNE menu*.
- ✔ You have specified the functions in X.TUNE.CONFIG.



16.2.1.2. X.TUNE.POS – Setting of the end positions

In this menu you can specify whether the pneumatic actuator has mechanical end positions or not. If there are no mechanical end positions available, these are not approached by the X.TUNE and must be manually specified.



Set the end position as follows:





- ▲ / ▼ Select M.TUNE.POS.
-  Select **ENTER**.
The selection for
ACT.limit = mechanical end positions available
ACT.nolimit = mechanical end positions not available
is displayed.

If mechanical end positions are available

- ▲ / ▼ Select ACT.limit.
-  Select **SELEC**. The selection is marked by a filled circle ●.
-  Select **EXIT**. Return to the *Manual.TUNE menu*.

If mechanical end positions are not available

- ▲ / ▼ Select ACT.nolimit.
-  Select **SELEC**. The CAL.POS submenu for inputting the end positions is opened.
- ▲ / ▼ Select POS.pMIN.
-  Select **INPUT**. The input screen for the value of the lower end position is opened.
- ▲ / ▼ **OPN** Increase value
CLS Changing the decimal place
Approach lower end position of the valve.
-  Select **OK**. Transfer and simultaneous return to the CAL.POS menu.
- ▲ / ▼ Select POS.pMAX.

-  Select **INPUT**. The input screen for the value of the upper end position is opened.
- ▲ / ▼ **OPN** Increase value
CLS Changing the decimal place
 Approach upper end position of the valve.
-  Select **OK**. Transfer and simultaneous return to the *CAL.POS* menu.
-  Select **EXIT**. Return to the *M.TUNE.POS.* menu.
-  Select **EXIT**. Return to the *Manual.TUNE* menu.
- ✔ You have set the end position.

16.2.1.3. *M.TUNE.PWM* – Optimization of the PWM signals

In this menu the PWM signals for control of the aeration valves and bleed valves are manually optimized.

For optimization the actuator is aerated and bled. A progress bar on the display indicates the position of the actuator and the speed of aeration and deaeration.

The setting is optimum when the progress bar moves as slowly as possible.







WARNING

Danger due to uncontrolled valve movement when the *M.TUNE.PWM* function is running.

When the *M.TUNE.PWM* function is running under operating pressure, there is an acute risk of injury.

- ▶ Never run *X.TUNE.PWM* while a process is running.
- ▶ Secure the device against accidental activation.

Optimize the PWM signals as follows:

- ▲ / ▼ Select *M.TUNE.PWM*.
-  Select **ENTER**.
 The submenu is displayed.
yB.min = aeration valve
yE.min = bleed valve
- ▲ / ▼ Select *yB.min*. Submenu for setting the PWM signal for the aeration valve.
-  Select **ENTER**. The input screen for setting the PWM signal is opened.
 The progress bar indicates the speed of aeration.
- ▲ / ▼ **+** Increase speed
- Reduce speed
 Minimize speed so that the progress bar moves as slowly as possible from left to right.
Note: Do not minimize speed to such an extent that the progress bar remains in one position.
-  Select **OK**. Transfer and simultaneous return to the *M.TUNE.PWM* menu.
- ▲ / ▼ Select *yE.min*. Submenu for setting the PWM signal for the bleed valve.
-  Select **ENTER**. The input screen for setting the PWM signal is opened.
 The progress bar indicates the speed of deaeration.

- ▲ / ▼ **+** Increase speed
- Reduce speed

Minimize speed so that the progress bar moves as slowly as possible from right to left.

Note: Do not minimize speed to such an extent that the progress bar remains in one position.

-  Select **OK**. Transfer and simultaneous return to the *M.TUNE.PWM* menu.

-  Select **EXIT**. Return to the *Manual.TUNE* menu.

 You have optimized the PWM signal.

16.2.1.4. *M.TUNE.AIR* – Determination of the opening and closing times

By running this function, the opening and closing times of the valve are determined continuously.

A change to the supply pressure will affect the aeration time which can be optimized in this way.

For the setting the effects, which a change to the supply pressure has on the aeration time, can be continuously monitored via the *M.TUNE.AIR* function.

Continuously determine the opening and closing times as follows:

- ▲ / ▼ Select *M.TUNE.AIR*.

-  Select **RUN**. Hold down as long as countdown (5 ...) is running.
The aeration and deaeration times are displayed.
time.open = aeration
time.close = deaeration

Change the supply pressure to adjust the aeration time.
The changed aeration time is displayed continuously.

-  Select **EXIT**. Return to the *Manual.TUNE* menu.

-  Select **EXIT**. Return to the main menu (MAIN).

-  Select **EXIT**. Switching from setting level ⇒ process level.

 You have continuously determined the opening and closing times.

17 ACCESS TO THE BÜS SERVICE INTERFACE

The bÜS service interface is located inside the device.

→ Remove the housing cover for access.

→ Ensure that a terminating resistor is used.

NOTE

Connect the bÜS service interface to the PC always via the USB-bÜS-Interface.

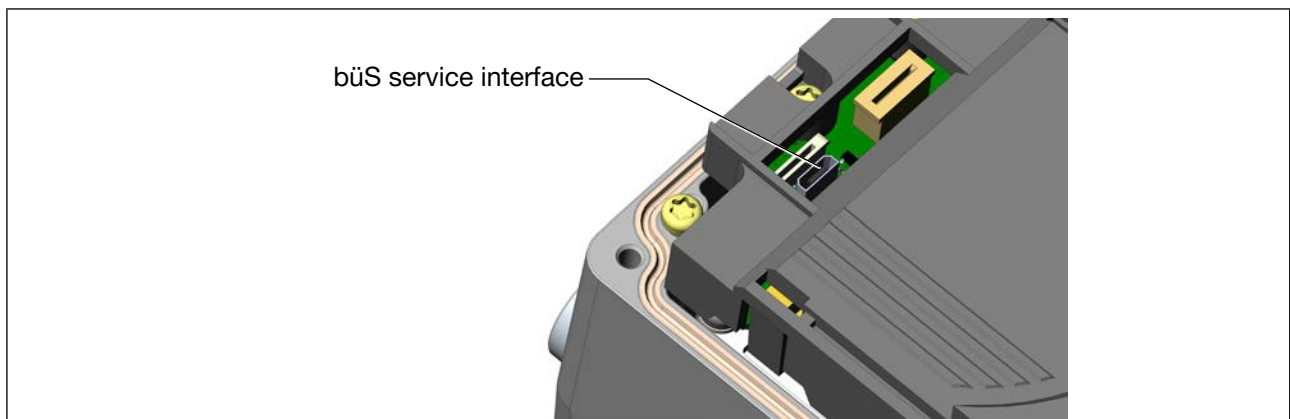

Figure 52: bÜS service interface

17.1 Setting options for start-up via Bürkert Communicator

- Setting with the Bürkert Communicator PC software on the PC

This type of setting is possible for all device types and device variants.

To do this, the device must be connected using the USB-bÜS interface sets and the bÜS service interface.

! The PC software Bürkert Communicator can be downloaded free of charge from the Bürkert homepage.
 To do this, the USB-bÜS interface set, available as an accessory, is required.
 Communication is established by the bÜS Service interface of the device (see chapter “23 Accessories”)

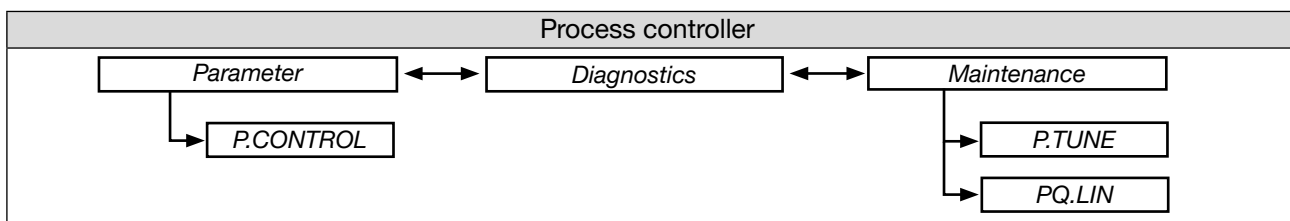

Table 48: Process controller level

MAN 1000341264 EN Version: F Status: RL (released | freigegeben) printed: 01.09.2023

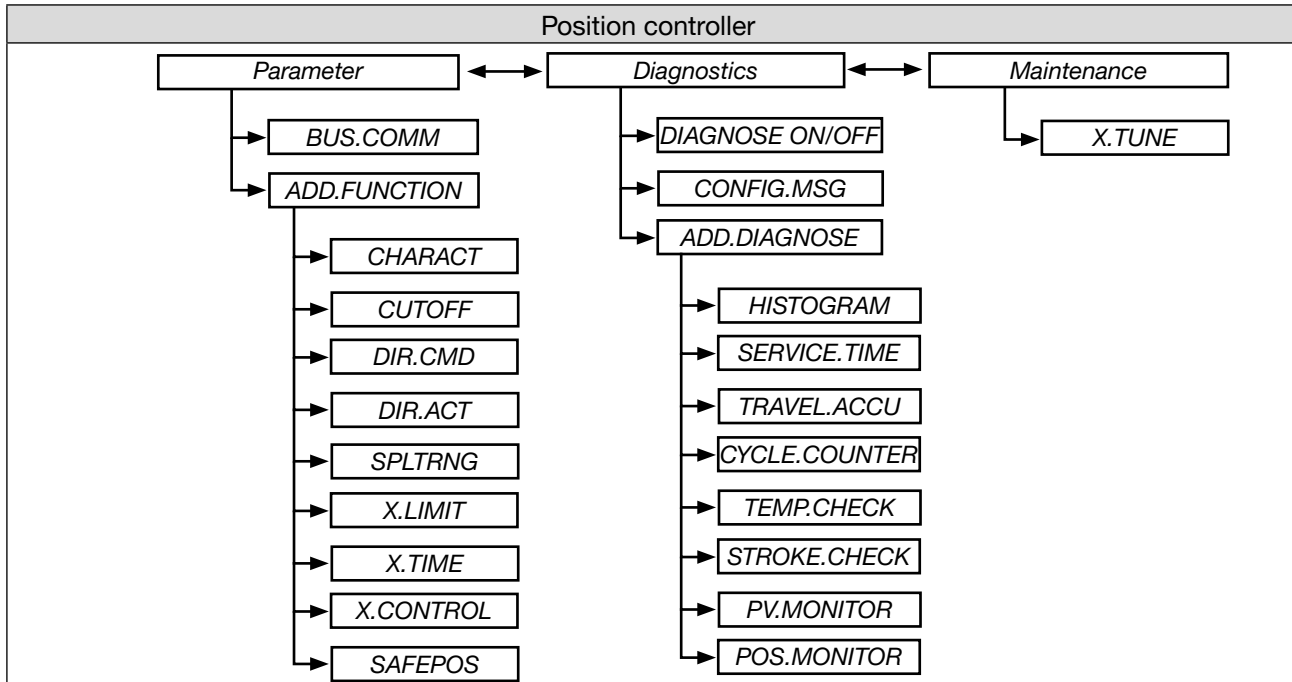

Table 49: Position controller level

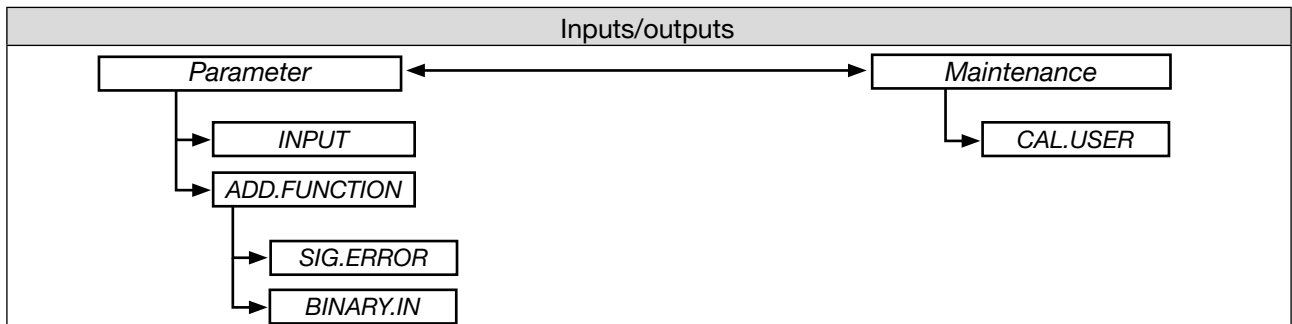
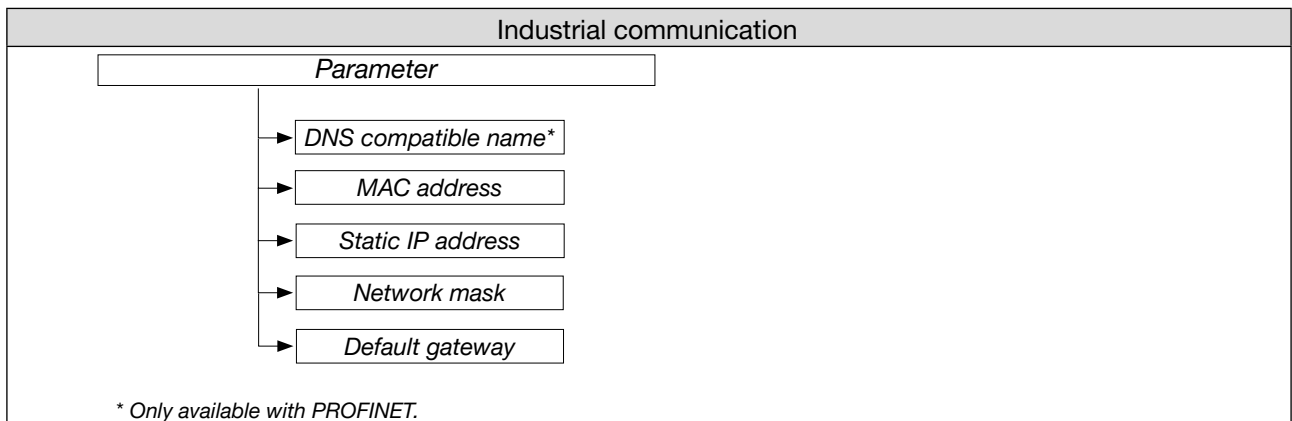

Table 50: Inputs/outputs level



* Only available with PROFINET.

Table 51: Industrial communication level (for Ethernet device only)

MAN 1000341264 EN Version: F Status: RL (released | freigegeben) printed: 01.09.2023

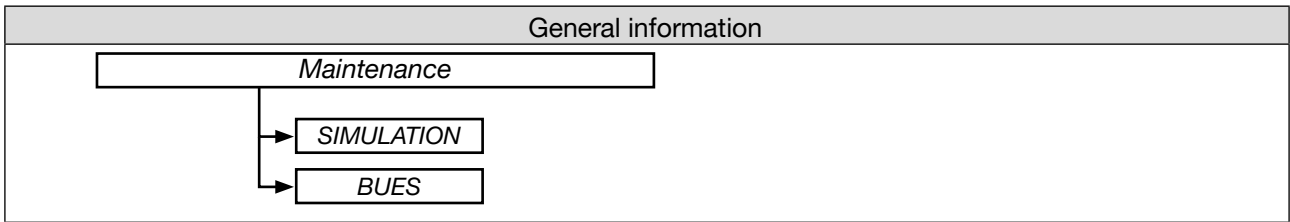

Table 52: General level

18 OPERATING STRUCTURE AND FACTORY SETTING

The factory presets are highlighted in blue to the right of the menu in the operating structure. Examples:

<input checked="" type="radio"/> / <input checked="" type="checkbox"/>	Menu options activated or selected at the factory
<input type="radio"/> / <input type="checkbox"/>	Menu options not activated or selected at the factory
2%, 10 sec, ...	Values set at the factory



Figure 53: Operating structure - 1

1) Only for fieldbus

MAN 1000341264 EN Version: F Status: RL (released | freigegeben) printed: 01.09.2023

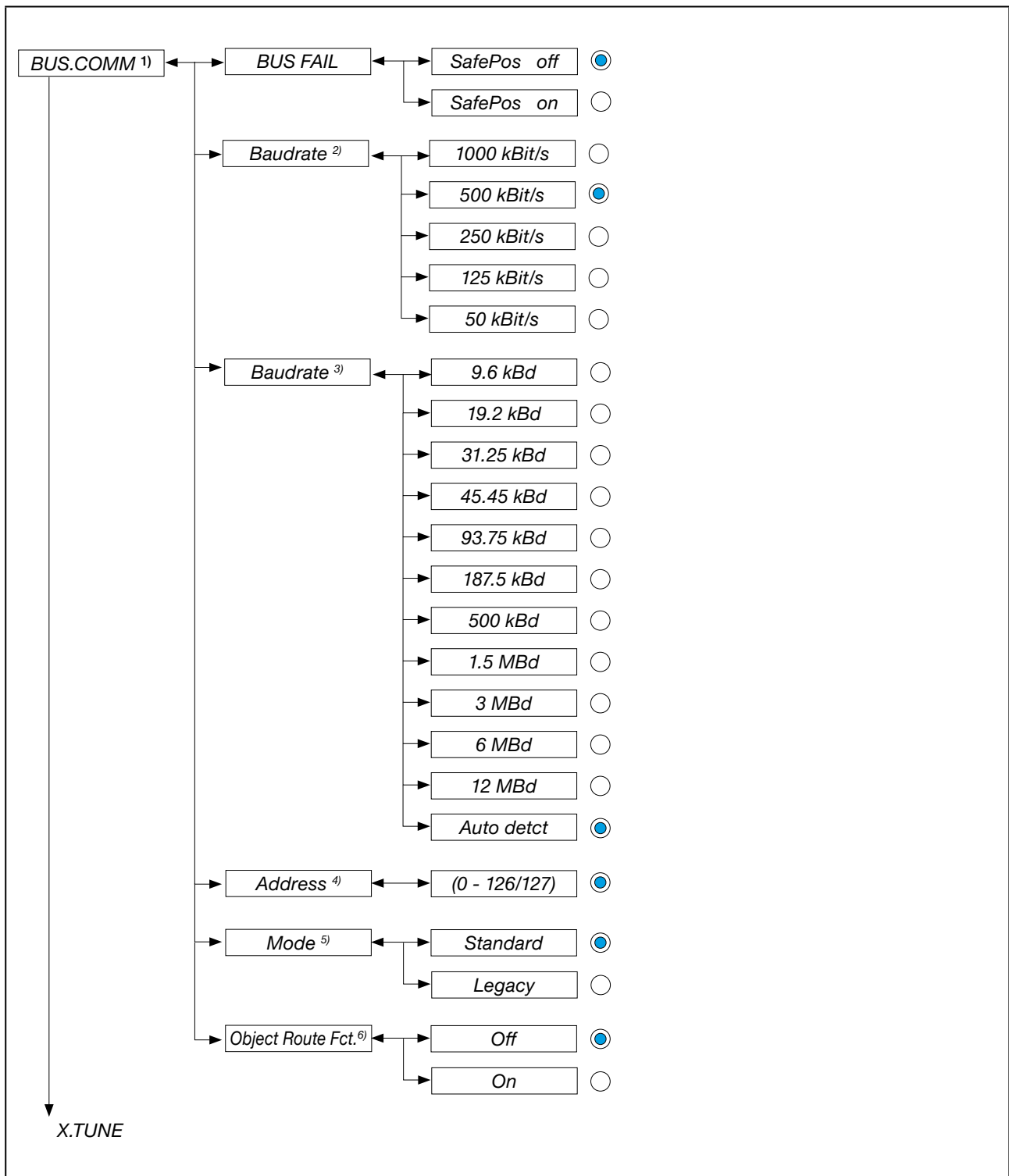

Figure 54: Operating structure - 2

- 1) Only for fieldbus
- 2) Only for büS
- 3) Only for PROFIBUS DPV1
- 4) Only for büS and PROFIBUS DPV1
- 5) Only for EtherNet/IP, PROFINET and Modbus TCP
- 6) Only for EtherNet/IP, PROFINET, Modbus TCP and PROFIBUS DPV1

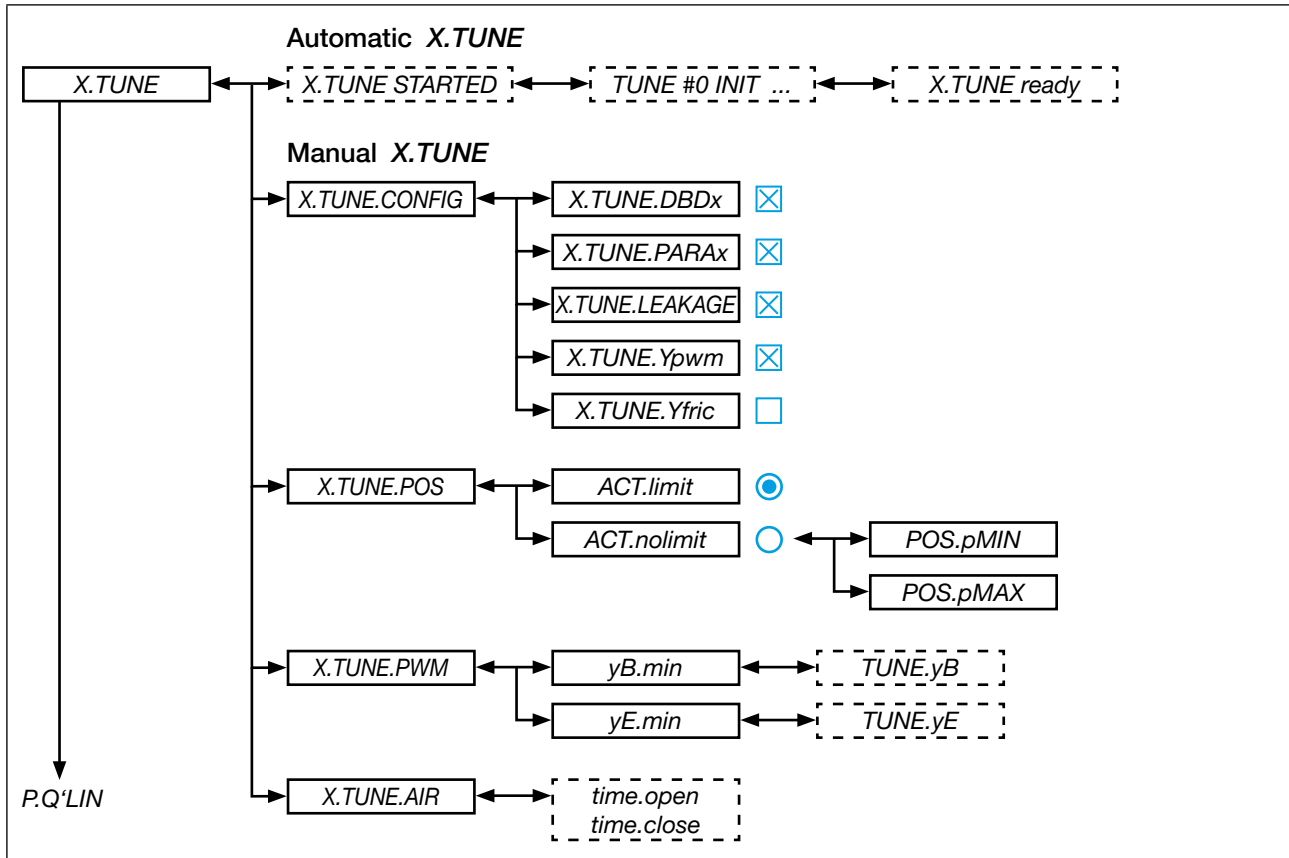
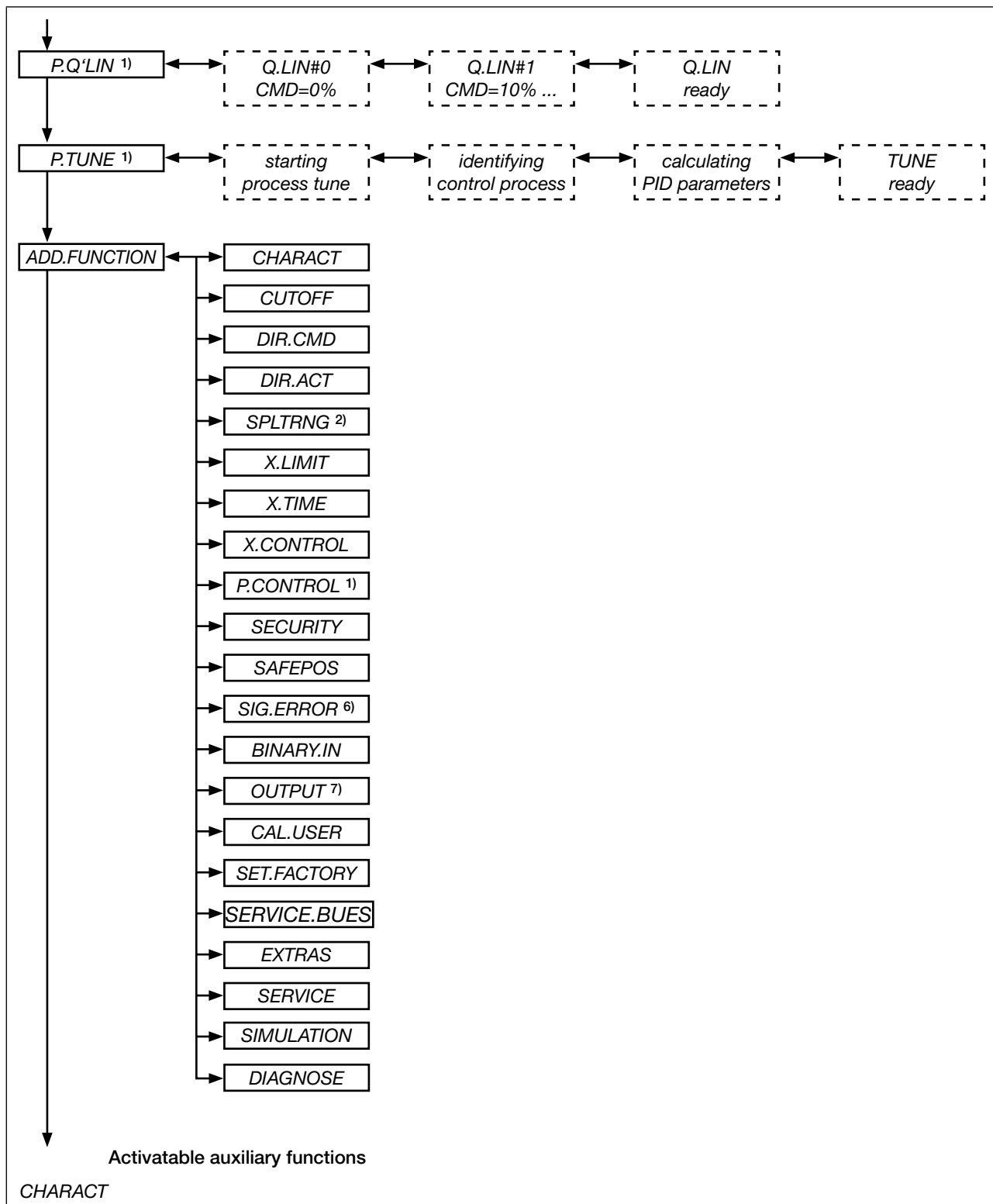

Figure 55: Operating structure - 3



MAN 1000341264 EN Version: F Status: RL (released | freigegeben) printed: 01.09.2023

Figure 56: Operating structure - 4

- 1) Only process controller Type 8793
- 2) Only for position controller mode
- 6) Only for signal type 4 – 20 mA and Pt 100
- 7) Optional. The number of outputs varies depending on the variant.

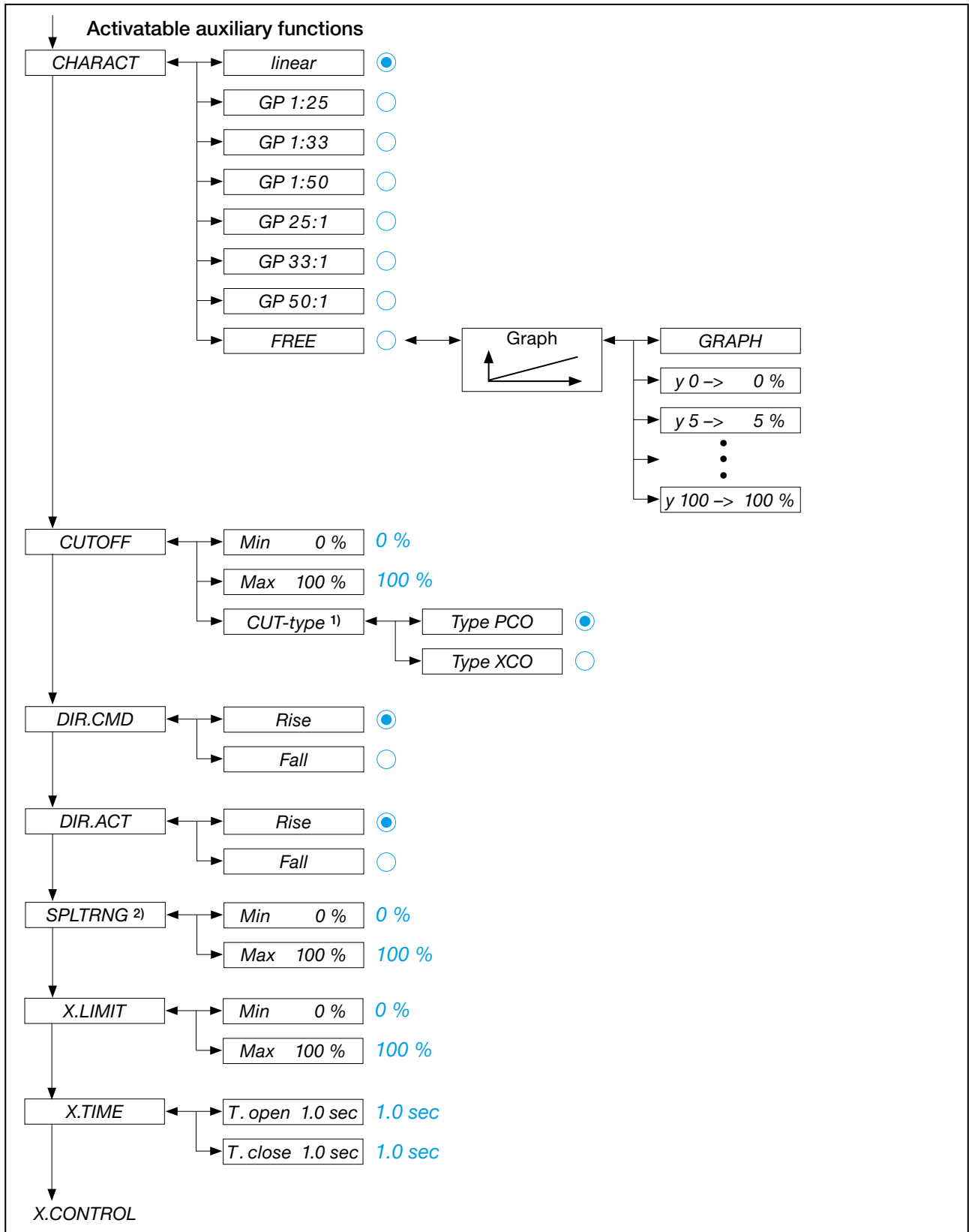

Figure 57: Operating structure - 5

1) Only process controller Type 8793

2) Only for position controller mode

MAN 1000341264 EN Version: F Status: RL (released | freigegeben) printed: 01.09.2023

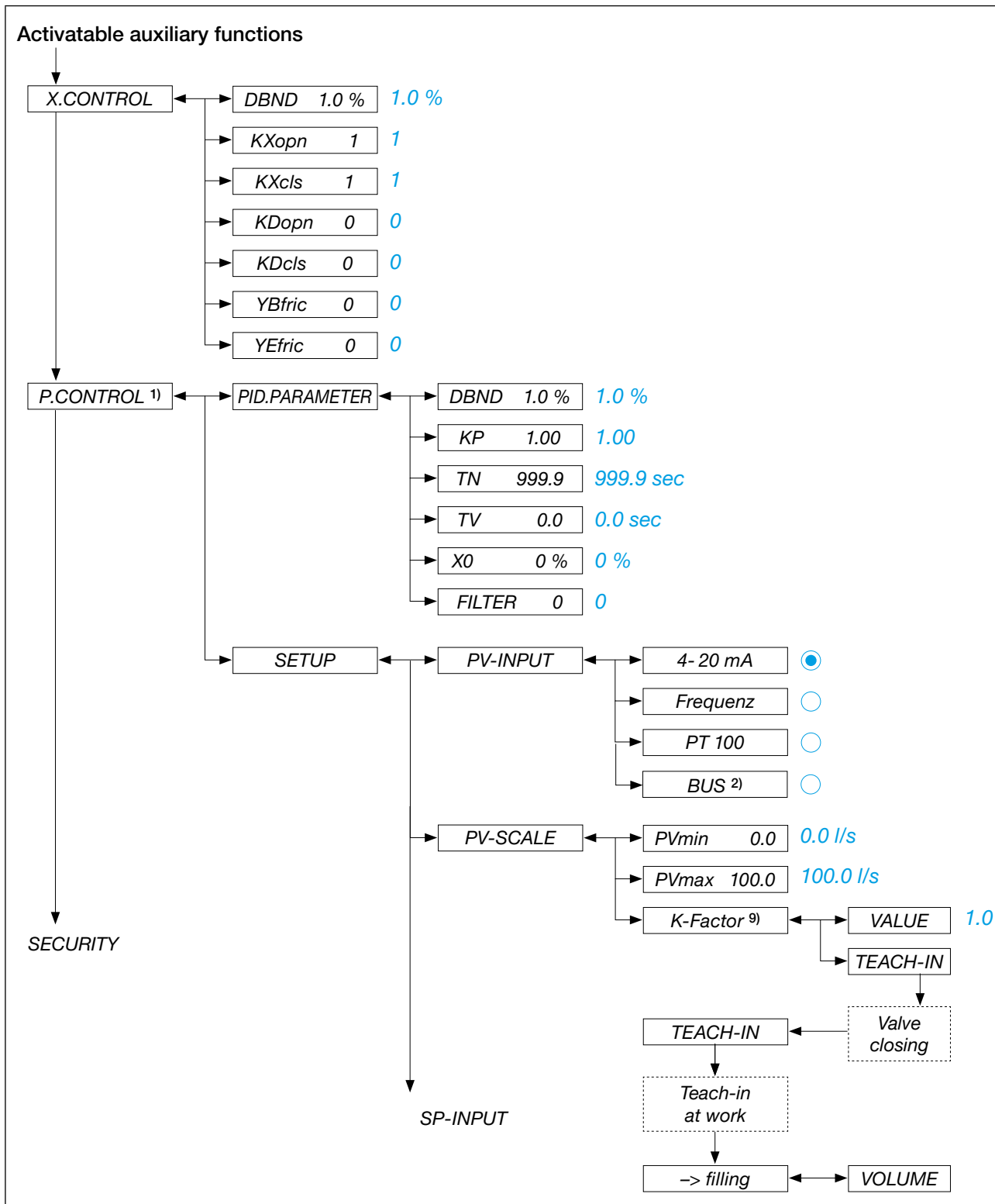

Figure 58: Operating structure - 6

- 1) Only process controller Type 8793
- 2) Only for bus devices
- 9) Only for signal type frequency (P.CONTROL → SETUP → PV-INPUT → frequency)

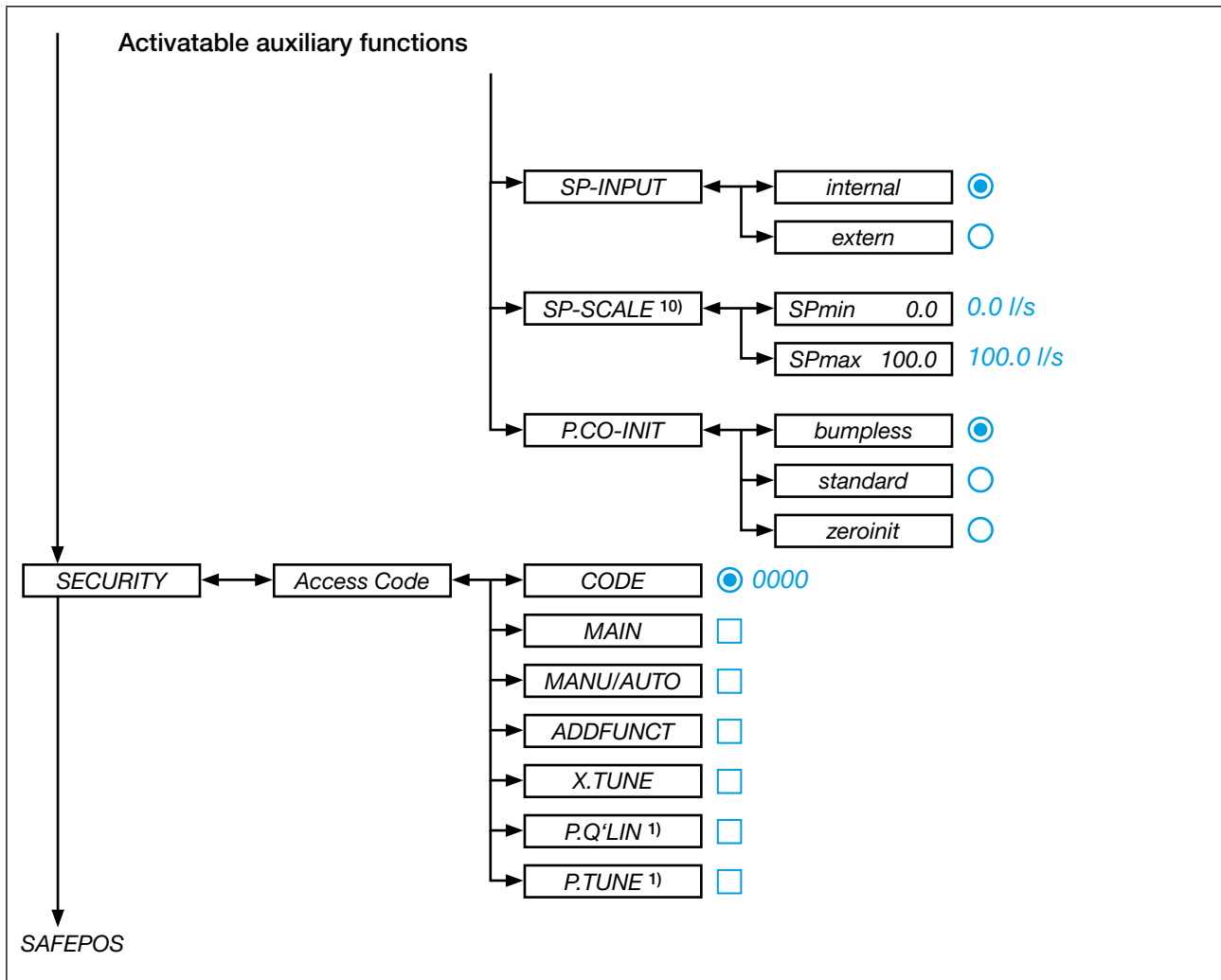
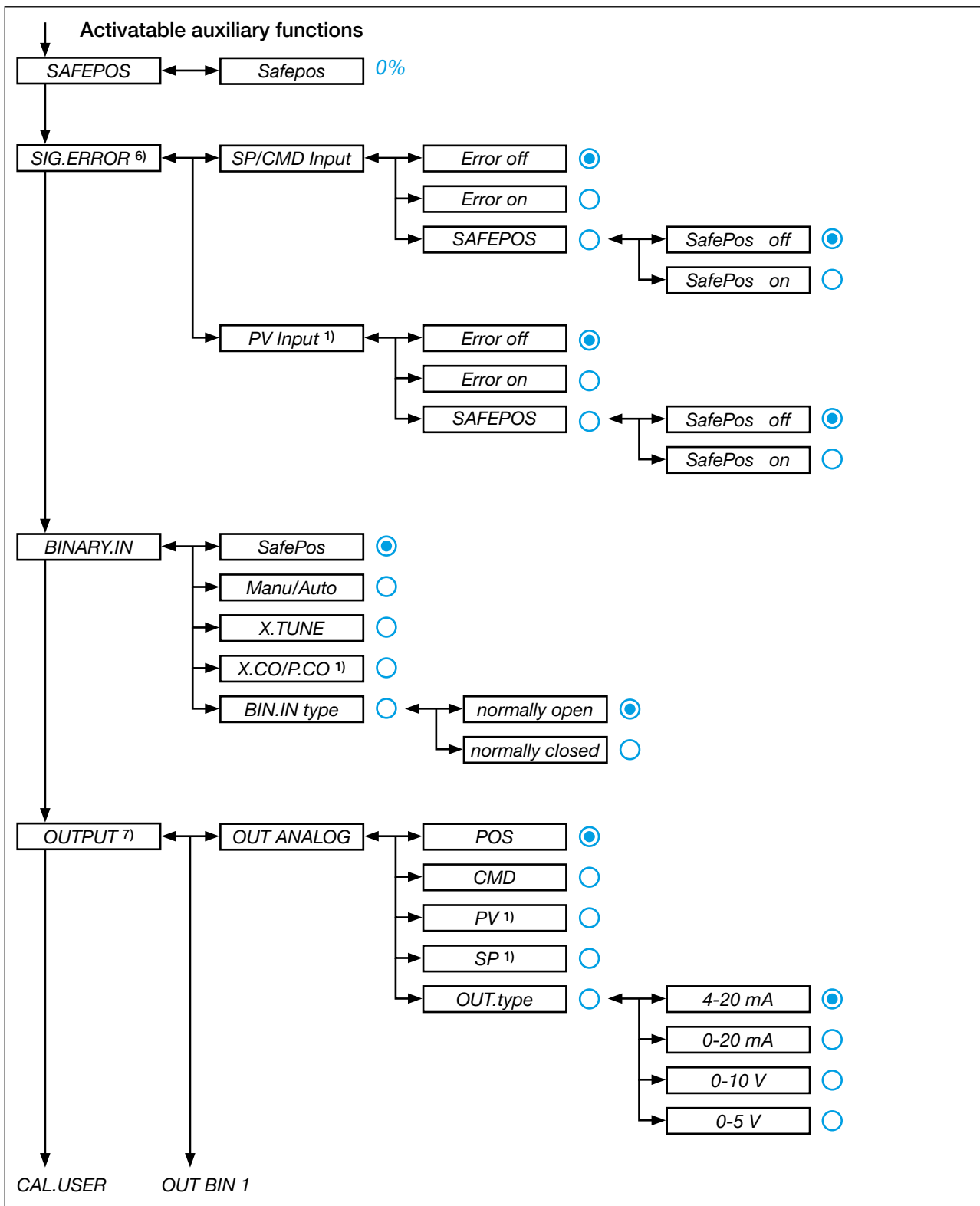

Figure 59: Operating structure - 7

1) Only process controller Type 8793

10) Only process controller Type 8793 and for external set-point value default (P.CONTROL → SETUP → SP-INPUT → external)



MAN 1000341264 EN Version: F Status: RL (released | freigegeben) printed: 01.09.2023

Figure 60: Operating structure - 8

- 1) Only process controller Type 8793
- 6) Only for signal type 4 – 20 mA and Pt 100
- 7) Optional. The number of outputs varies depending on the variant.

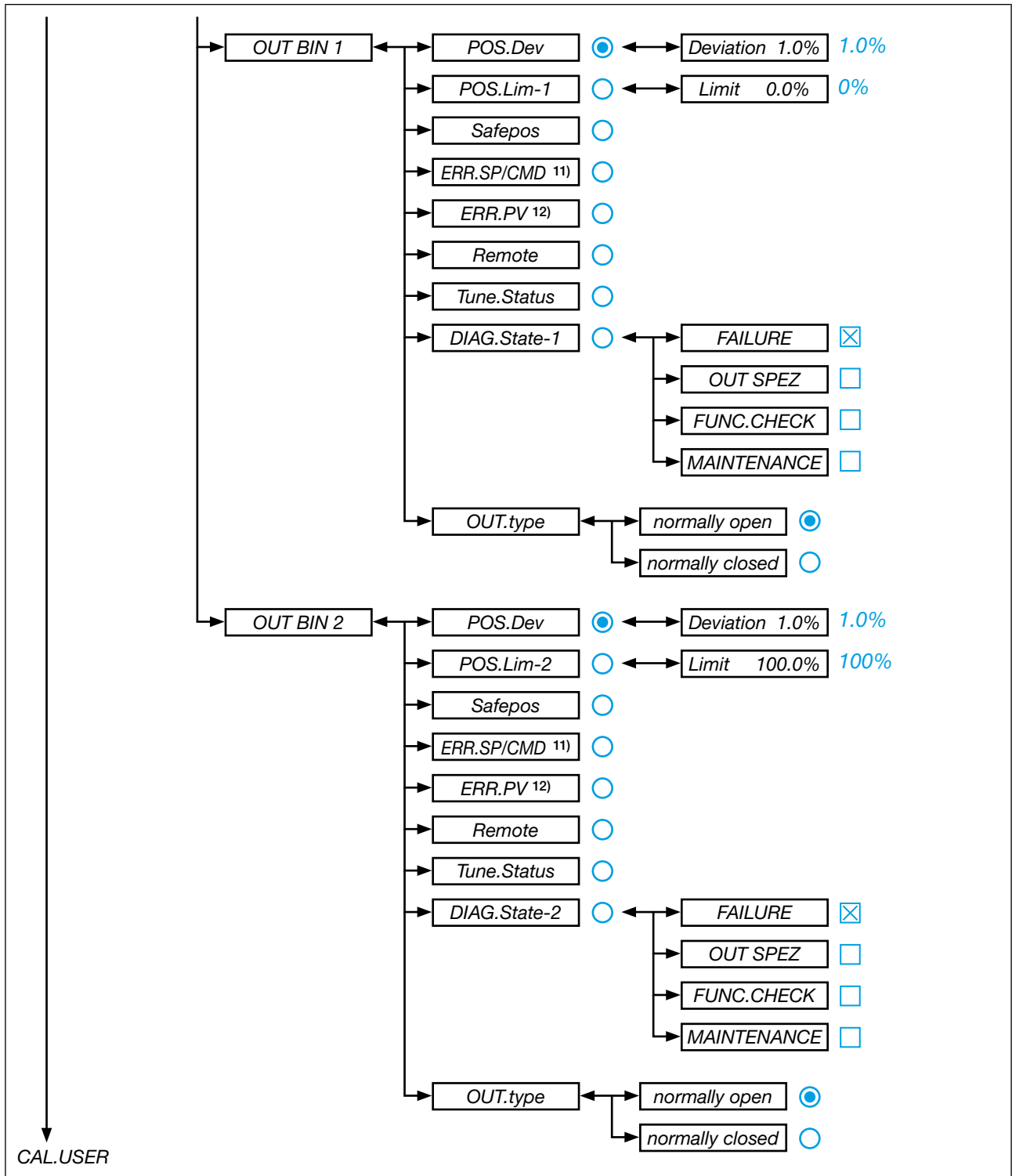

Figure 61: Operating structure - 9

- 11) Only if fault detection is activated for the input signal (SIG.ERROR → SP/CMD Input or PV-Input → Error on)
- 12) Only process controller Type 8793 and if fault detection is activated for the input signal (SIG.ERROR → SP/CMD Input or PV-Input → Error on)

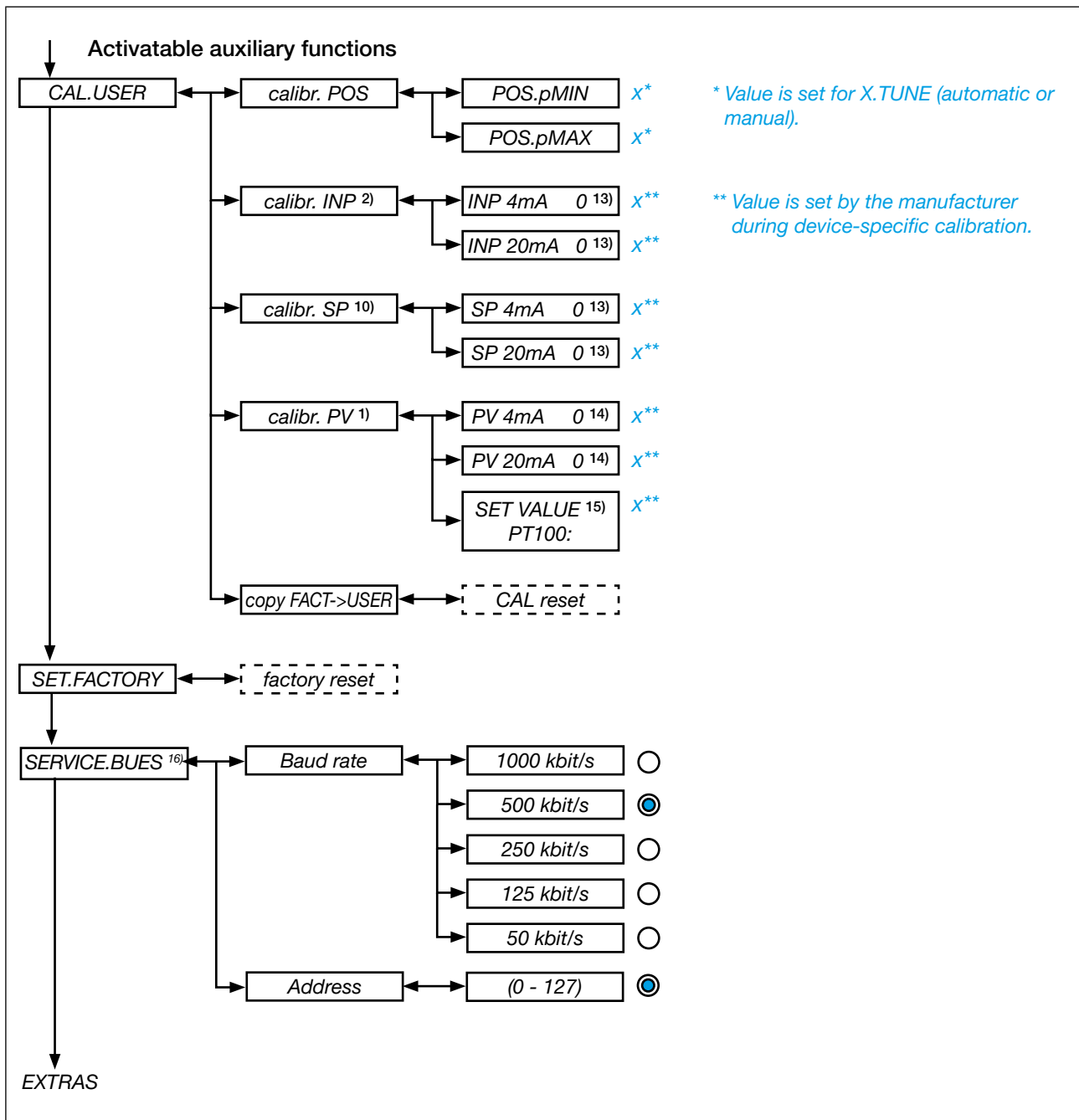

Figure 62: Operating structure - 10

- 1) Only process controller Type 8793
- 2) Only for position controller mode
- 10) Only process controller Type 8793 and for external set-point value default (P.CONTROL → SETUP → SP-INPUT → external)
- 13) The signal type is displayed which is selected in the INPUT menu
- 14) Only for signal type 4 – 20 mA (P.CONTROL → SETUP → PV-INPUT → 4 – 20 mA)
- 15) Only for circuit with Pt 100 (P.CONTROL → SETUP → PV-INPUT → PT 100)
- 16) Only for devices other than büS

MAN 1000341264 EN Version: RL (released | freigegeben) printed: 01.09.2023

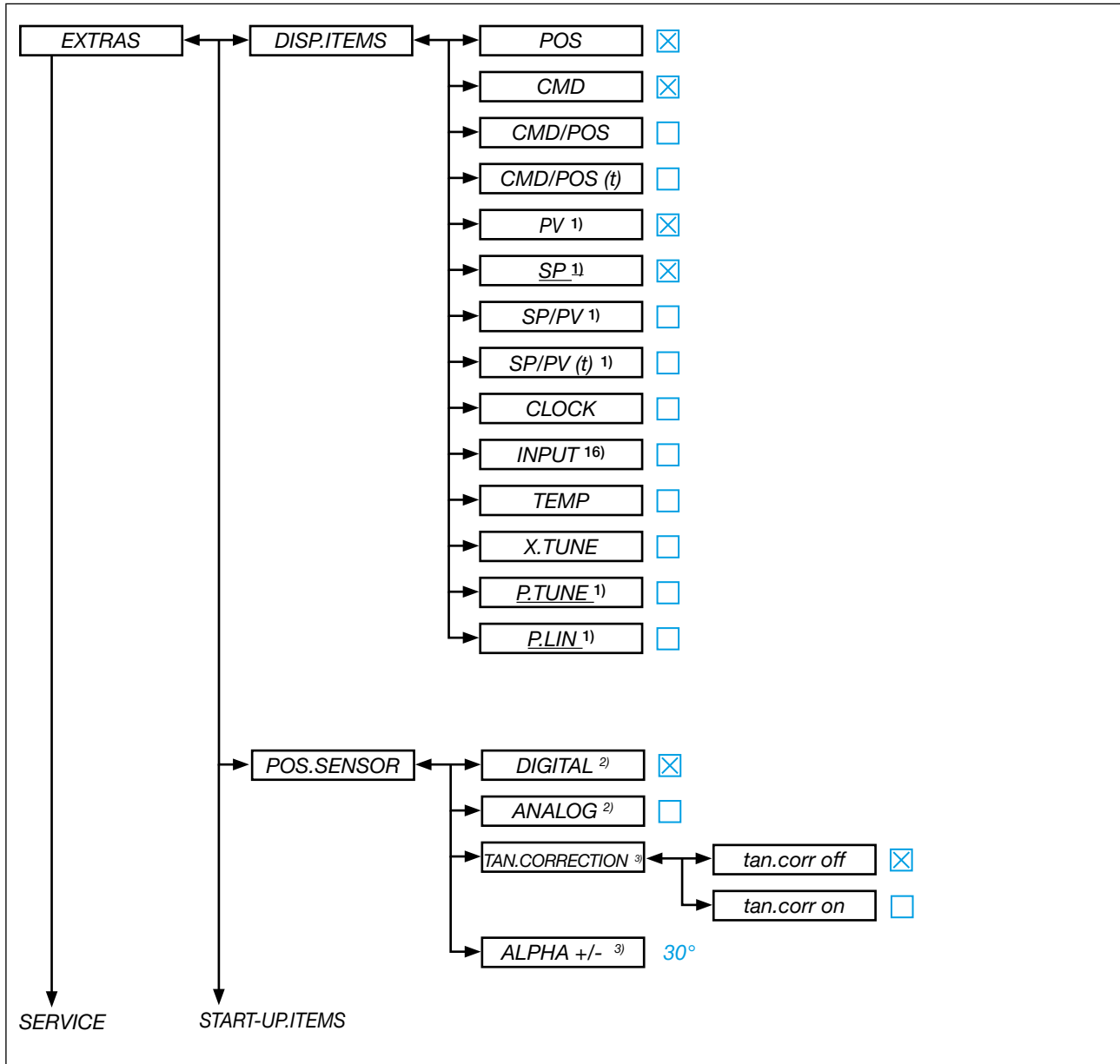

Figure 63: Operating structure - 11

- 1) Only process controller Type 8793
- 2) Only Type 8793 Remote
- 3) All devices other than Remote
- 16) Not for fieldbus

MAN 1000341264 EN Version: F Status: RL (released | freigegeben) printed: 01.09.2023

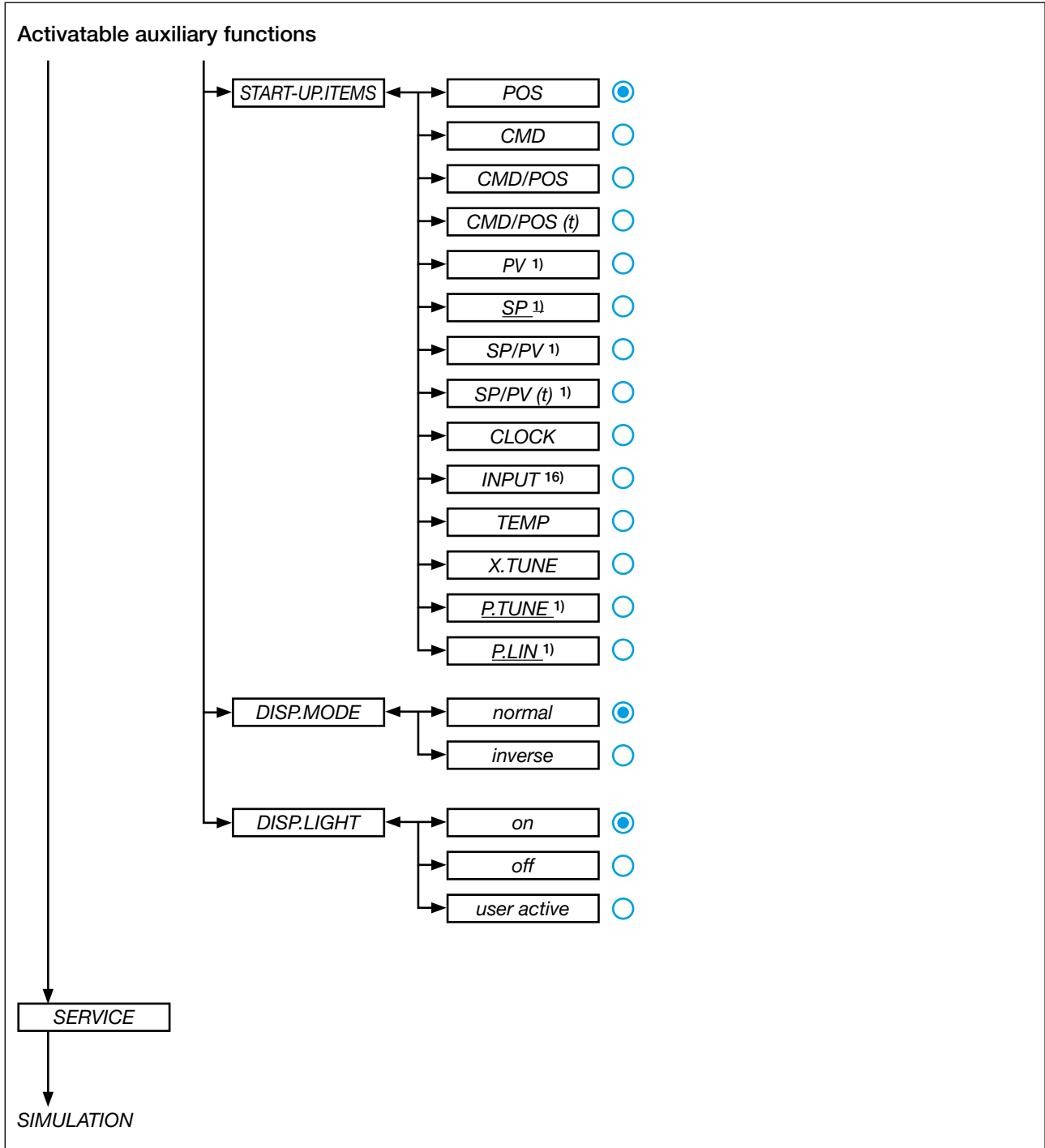

Figure 64: Operating structure - 12

1) Only process controller Type 8793

16) Not for fieldbus

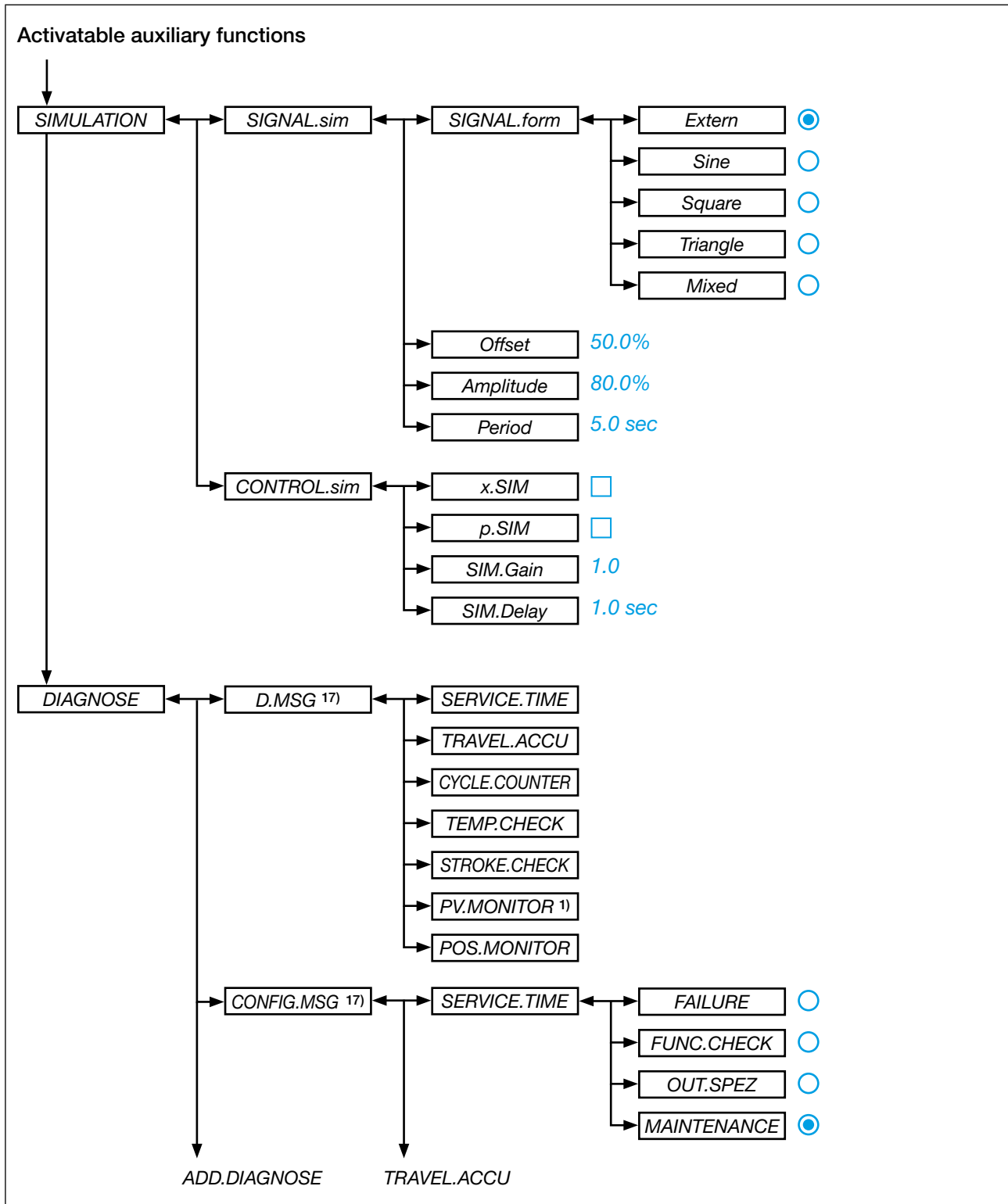

Figure 65: Operating structure - 13

1) Only process controller Type 8793

17) The submenu lists only the activated diagnostic functions

MAN 1000341264 EN Version: F Status: RL (released | freigegeben) printed: 01.09.2023

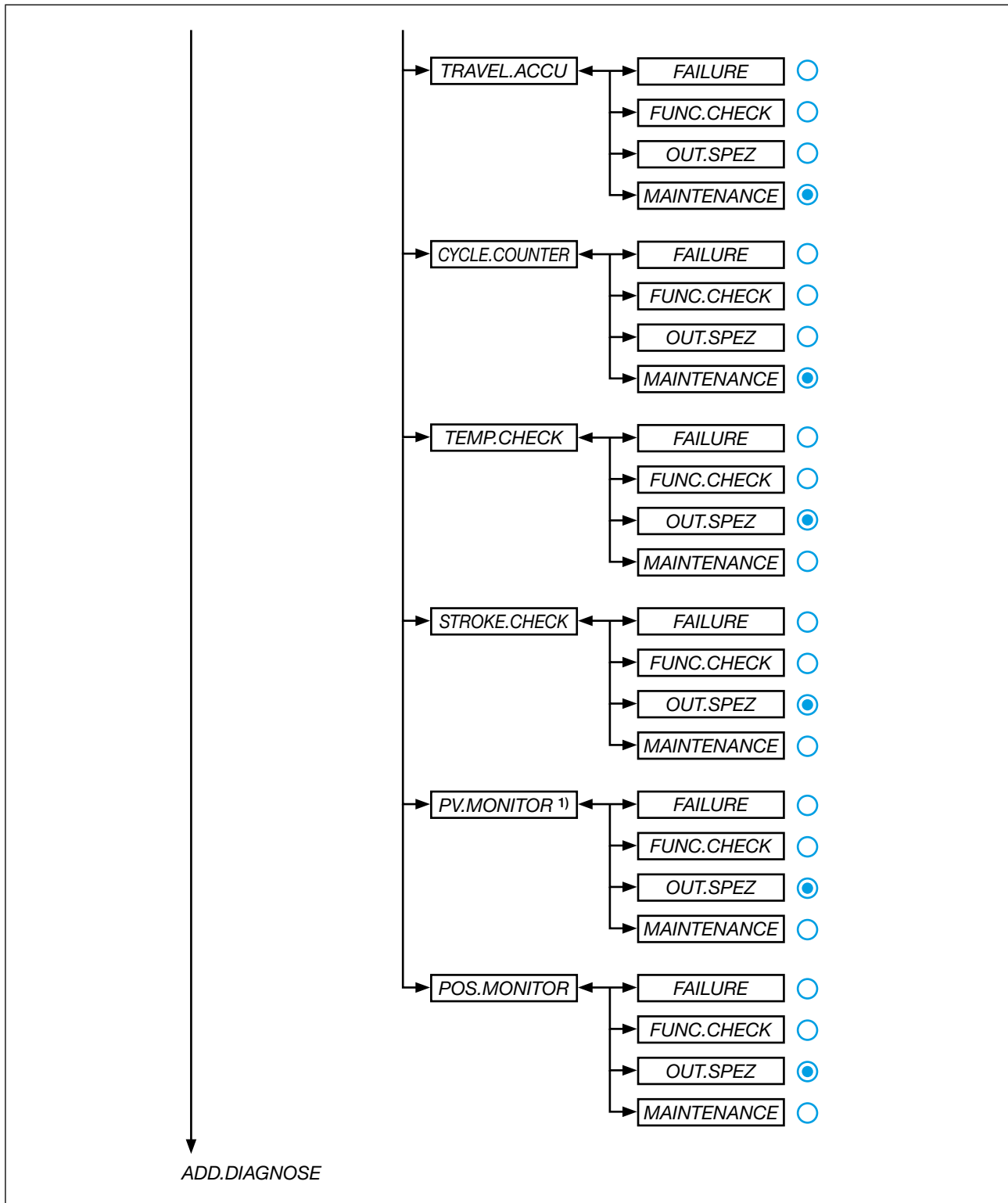

Figure 66: Operating structure - 14

1) Only process controller Type 8793

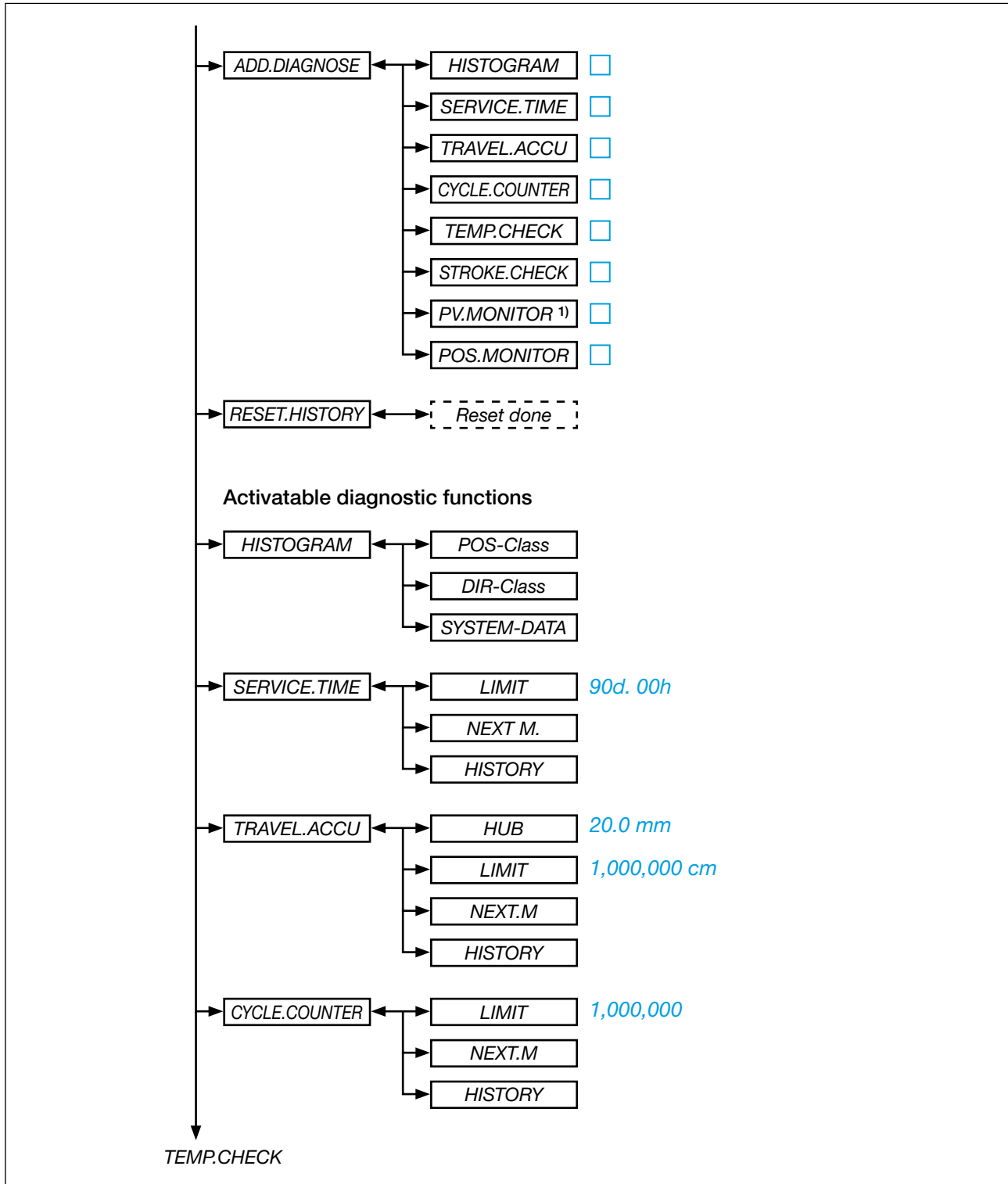

Figure 67: Operating structure - 15

MAN 1000341264 EN Version: F Status: RL (released | freigegeben) printed: 01.09.2023

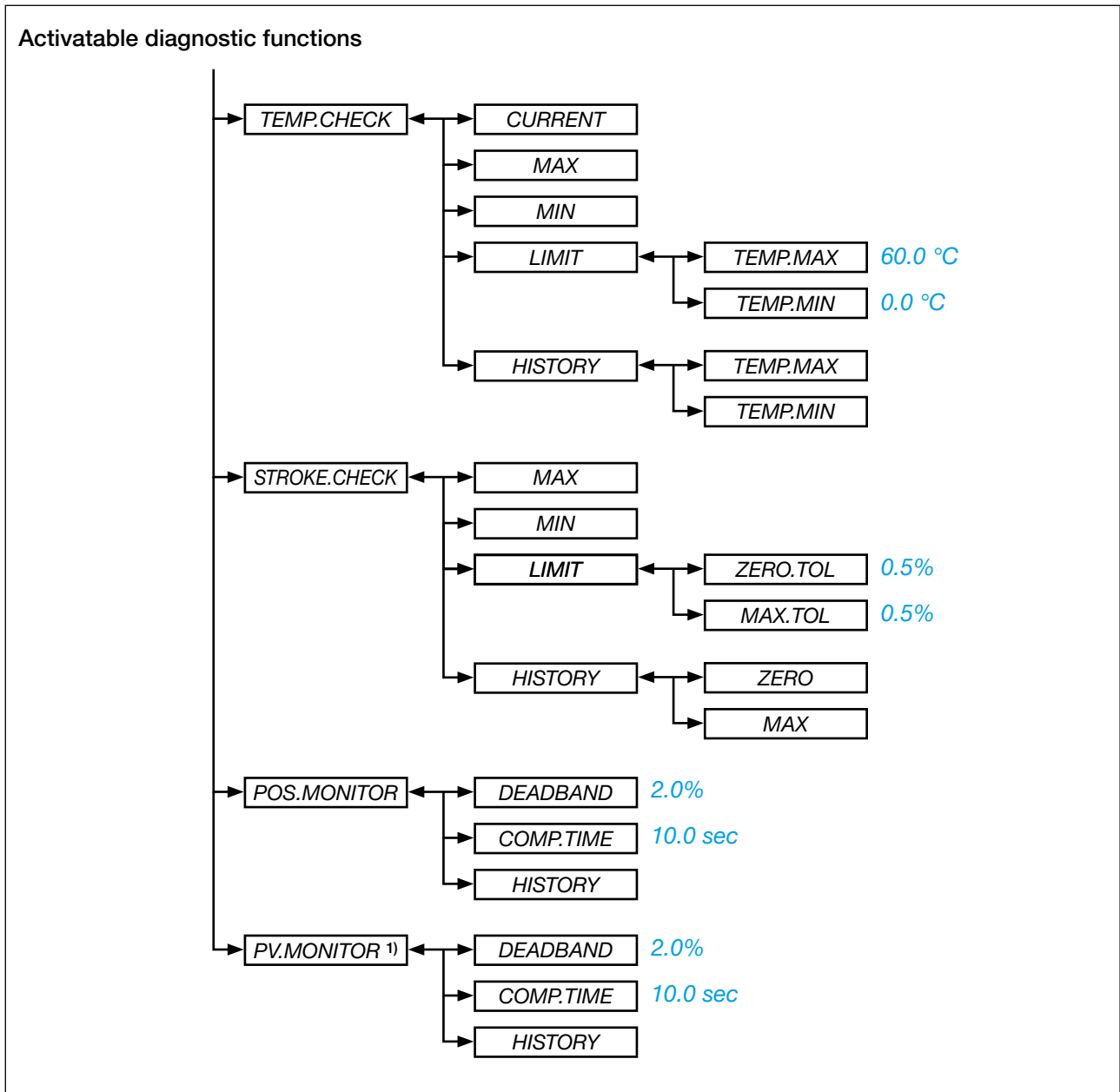

Figure 68: Operating structure - 16

MAN 1000341264 EN Version: F Status: RL (released | freigegeben) printed: 01.09.2023

1) Only process controller Type 8793

19 ETHERNET/IP, PROFINET AND MODBUS TCP



DANGER

Risk of injury due to electric shock.

- ▶ Before reaching into the system, switch off the power supply and secure to prevent reactivation.
- ▶ Observe the applicable accident prevention regulations and safety regulations for electrical equipment.



WARNING

Risk of injury from improper installation.

- ▶ Installation may be carried out by authorized technicians only and with the appropriate tools.

Risk of injury due to unintentional switching on of the plant and uncontrolled start-up.

- ▶ Secure the device against accidental activation.
- ▶ Following installation, ensure a controlled restart.

19.1 Technical data

Network speed	10/100 mbps
Auto negotiation	Yes
Switch function	Yes
Network diagnostics	Yes, via error telegram
MAC-ID	Individual identification number, stored in the module and on the outside of the device (see type label)
Device name Ethernet (factory settings)	Positioner / process controller (name can be changed)

19.2 Interfaces

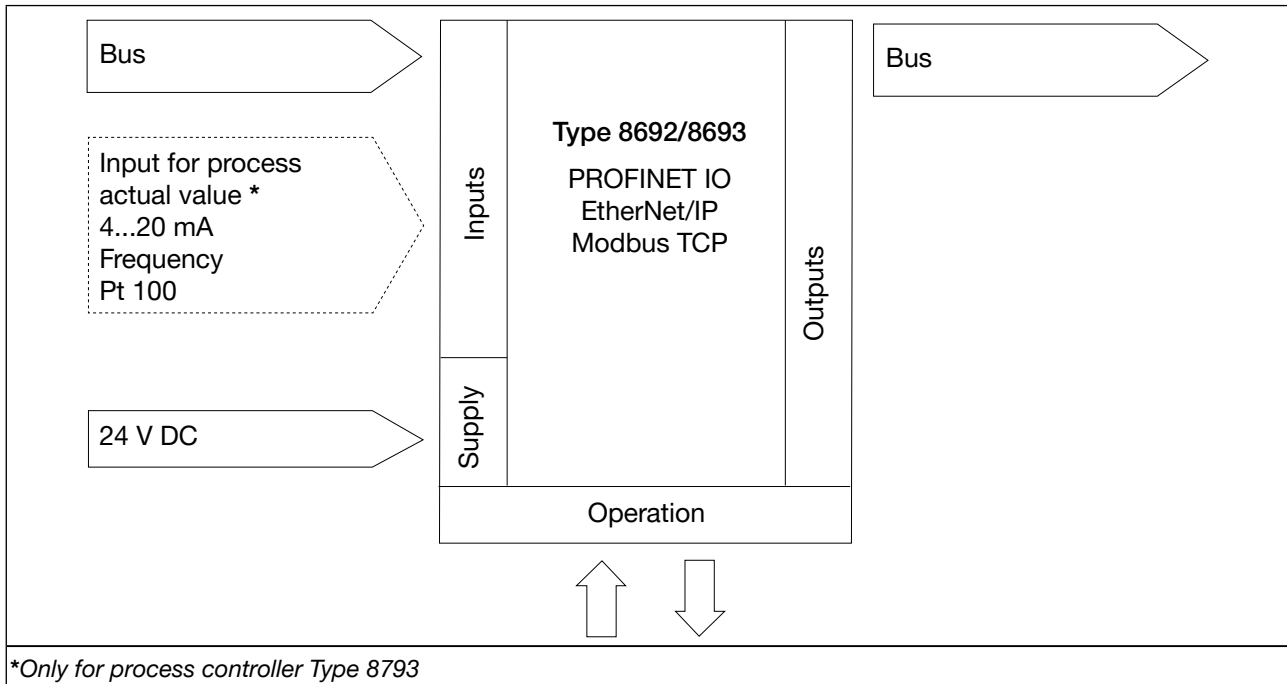

Figure 69: Interfaces Industrial Ethernet

19.3 Industrial Ethernet

PROFINET IO specifications

DNS compatible name	No entry
Static IP address	0.0.0.0
Network mask	0.0.0.0
Default gateway	0.0.0.0

In accordance with the PROFINET specification, these factory settings allow address assignment via the DCP and LLDP services. This means that no additional tools and no new project planning are required when replacing a device.

Topology recognition	LLDP, SNMP V1, MIB2, physical device
Minimum cycle time	10 ms
IRT	Not supported
MRP media redundancy	MRP client is supported
Further supported functions	DCP, VLAN priority tagging, shared device
Transfer rate	100 mbit/s
Data transport network	Ethernet II, IEEE 802.3
PROFINET IO specification	V2.3
(AR) Application Relations	The device can simultaneously process up to 2 IO ARs, 1 Supervisor AR, and 1 Supervisor DA AR.

EtherNet/IP specifications

Static IP address	192.168.0.100
Network mask	255.255.255.0
Default gateway	192.168.0.1
Predefined standard objects	Identity Object (0x01) Message Router Object (0x02) Assembly Object (0x04) Connection Manager (0x06) DLR Object (0x47) QoS Object (0x48) TCP/IP Interface Object (0xF5) Ethernet Link Object (0xF6)
DHCP	Supported
BOOTP	Supported
Transfer rate	10 and 100 mbit/s
Duplex modes	Half duplex, full duplex, auto negotiation
MDI modes	MDI, MDI-X, Auto-MDIX
Data transport network	Ethernet II, IEEE 802.3
Address Conflict Detection (ACD)	Supported
DLR (ring topology)	Supported
CIP reset service	Identity object reset service Types 0 and 1

Modbus TCP specifications

Static IP address	192.168.0.100
Network mask	255.255.255.0
Default gateway	192.168.0.1
Modbus function codes	1, 2, 3, 4, 6, 15, 16, 23
Operation mode	Message mode: Server
Transfer rate	10 and 100 mbit/s
Data transport network	Ethernet II, IEEE 802.3

MAN 1000341264 EN Version: F Status: RL (released | freigegeben) printed: 01.09.2023

19.4 Pin assignment

19.4.1 Connection diagram Type 8792

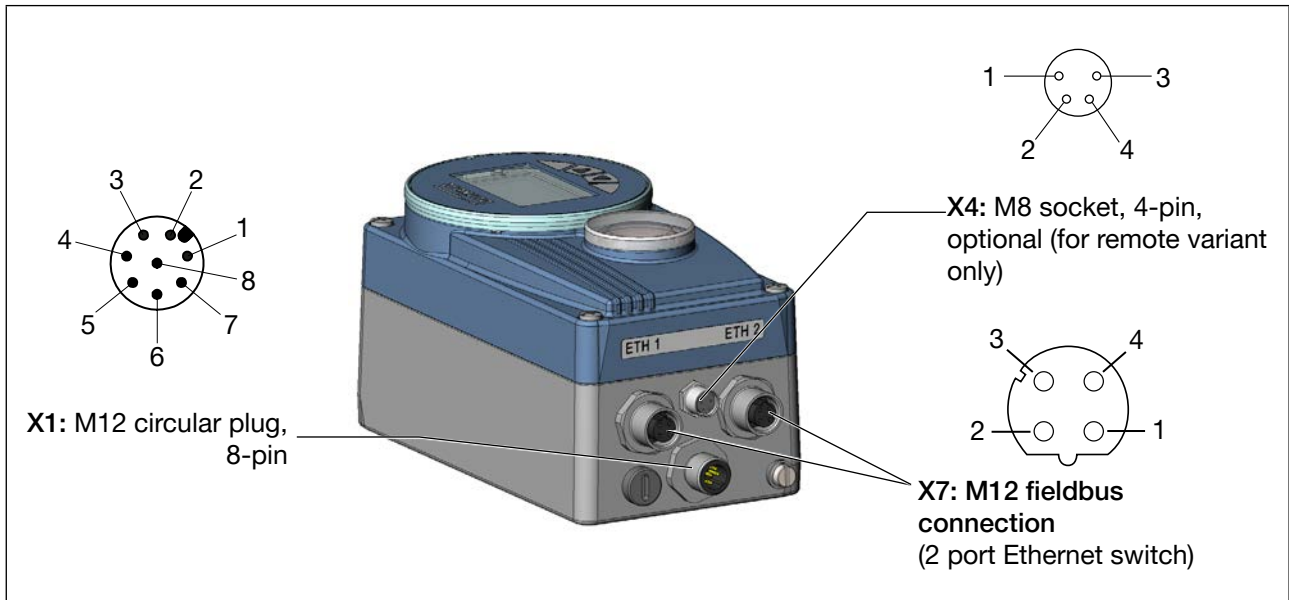

Figure 70: Fieldbus connection, positioner Type 8792

19.4.2 Connection diagram Type 8793

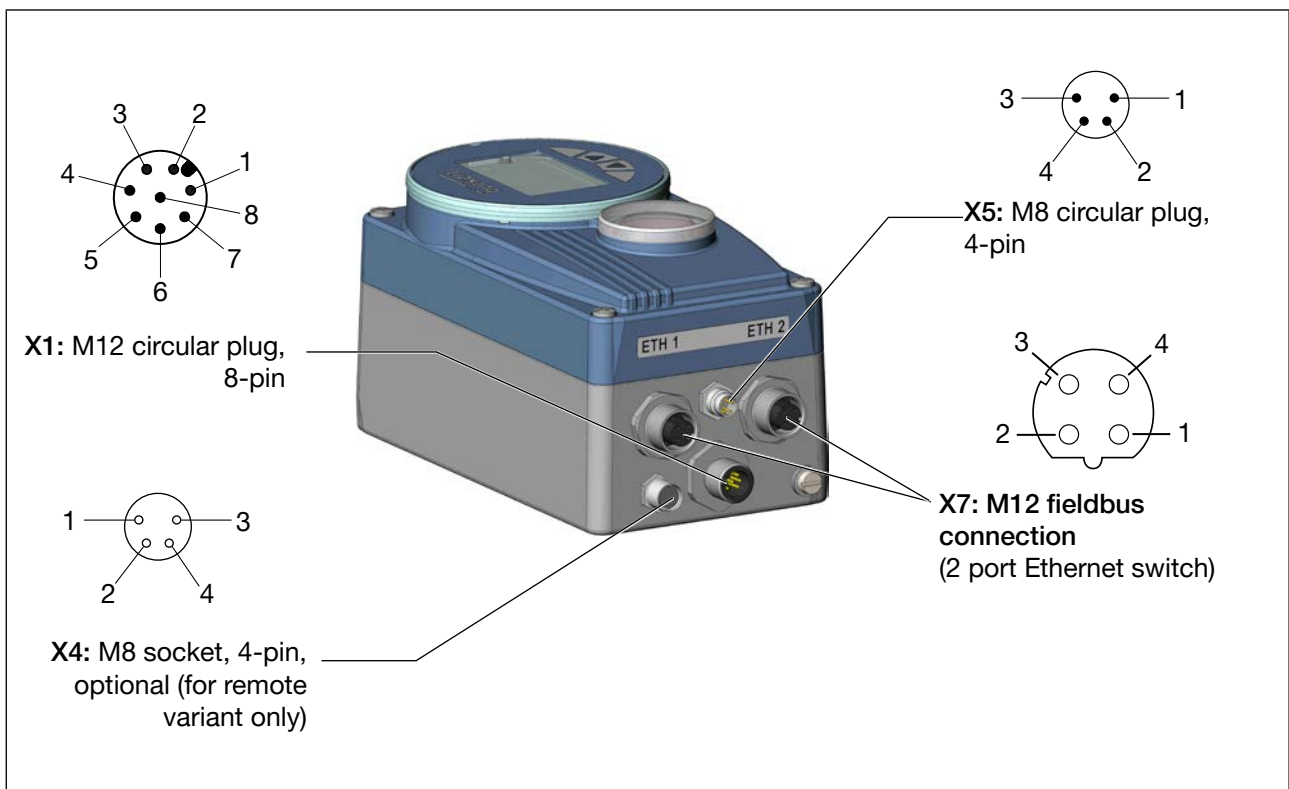

Figure 71: Fieldbus connection, process controller Type 8793

MAN 1000341264 EN Version: F Status: RL (released | freigegeben) printed: 01.09.2023

19.4.3 X7: M12 fieldbus connection D-coded

The EtherNet/IP is connected with an M12 circular plug-in connector, 4-pin D-coded

	Pin 1	Transmit +
	Pin 2	Receive +
	Pin 3	Transmit -
	Pin 4	Receive -

Table 53: Electrical assignment EtherNet

19.4.4 X1: M12 circular plug, 8-pin

Pin	Assignment	On the device side	External circuit / signal level
1	Not assigned		
2	Not assigned		
Operating voltage			
3	GND		24 V DC ±10 % max. residual ripple 10 %
4	+ 24 V		
Input signal of the control center (e.g. PLC)			
5	Digital input +		0...5 V (logical 0) 10...30 V (logical 1)
6	Digital input -		
Output signals to the control center (e.g. PLC) - (assigned for the digital output option only)			
7	Digital output 1 (referring to Pin 3)	7	0...24 V
8	Digital output 2 (referring to Pin 3)	8	0...24 V

Table 54: X1, M12 circular plug, 8-pin (operating voltage)

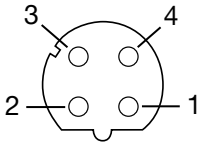
19.4.5 X4: M8 socket, 4-pin, optional - Remote sensor (for remote variant only)

Connection of the digital, non-contacting position sensor Type 8798:

Pin	Assignment	On the device side	External circuit
1	Supply sensor +	S +	
2	Supply sensor -	S -	
3	Serial interface, A cable	A	
4	Serial interface, B cable	B	

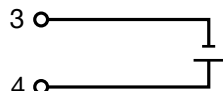
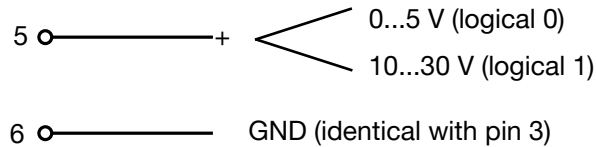
Table 55: Pin assignment; X4, M8 socket, 4-pin - digital, non-contacting position sensor Type 8798

Connection of an analog, potentiometric position sensor:

Pin	Assignment	On the device side	External circuit
1	Potentiometer 1	1	
2	Sliding contact 2	2	
3	Potentiometer 3	3	
4	Not assigned		

Table 56: Pin assignment; X4 - M8 socket - 4-pin - analog, potentiometer-type position sensor

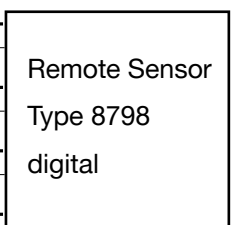
19.4.6 X5: M8 circular plug, 4-pin - Process actual value (for Type 8793)

Input type*	Pin	Wire color **	Assignment	DIP switches***	On the device side	External circuit
4 – 20 mA - internally supplied	1 2 3 4	brown white blue black	+24 V transmitter power supply Output from transmitter GND (identical to GND operating voltage) Bridge after GND (Pin 3)	 Switch on left		
4 – 20 mA - externally supplied	1 2 3 4	brown white blue black	Not assigned Process actual + Not assigned Process actual -	 Switch on right		
Frequency - internally supplied	1 2 3 4	brown white blue black	+24 V sensor power supply Clock input + Clock input - (GND) Not assigned	 Switch on left		
Frequency - externally supplied	1 2 3 4	brown white blue black	Not assigned Clock input + Clock input - Not assigned	 Switch on right		
Pt 100 (see information below)	1 2 3 4	brown white blue black	Not assigned Pt 100 power supply Pt 100 GND Pt 100 compensation	 Switch on right		

* Can be adjusted via software (see chapter "14.2.1 INPUT - Setting the input signal")

** The indicated wire colors refer to the connection cable available as an accessory (92903474).

*** The switch is located inside the device on the printed circuit board (see "Figure 25: Location of the switch; symbols for switch position")

Table 57: Pin assignment; X5 - M8 circular plug, 4-pin - process actual value input

MAN 1000341264 EN Version: F Status: RL (released | freigegeben) printed: 01.09.2023

NOTE

To ensure electromagnetic compatibility (EMC), use a shielded Ethernet cable. Ground the cable shield on both sides, on each of the connected devices.
For the grounding use a short line (max. 1 m) with a cross-section of at least 1.5 mm².

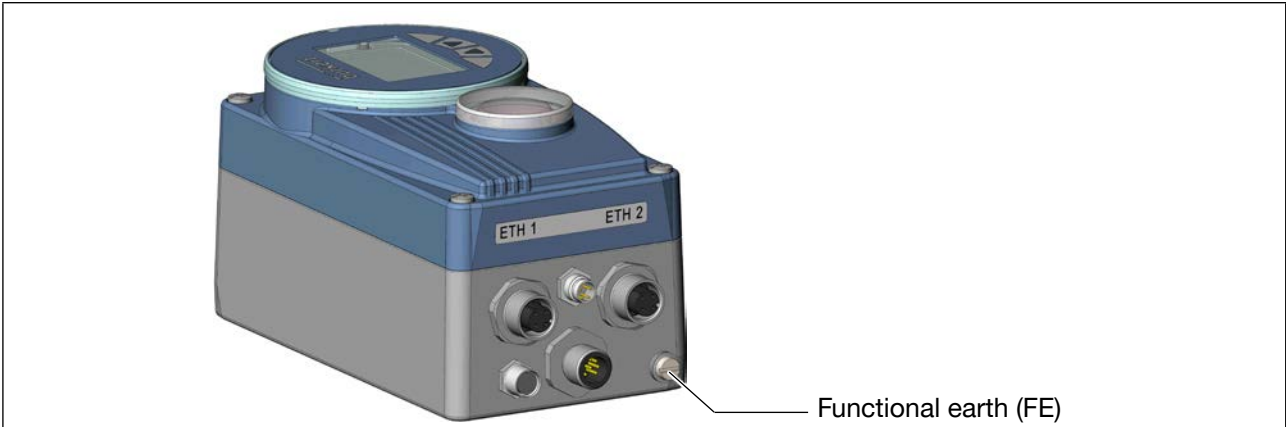

Figure 72: Functional earth

19.4.7 Switch position (only type 8793)

For the “internally supplied” input type, the GND signal of the process actual value must be connected to the GND signal of the operating voltage. A bridge is established internally between both GND signals using the “left” switch position.

Supplied	Assignment	Switch position
Internally supplied	GND process actual value equal to GND operating voltage	Switch on left
Externally supplied	GND process actual value electrically isolated from GND operating voltage	Switch on right

Table 58: Switch position

19.5 Bus status display

The bus status is indicated on the display on the device.

Display	Device state	Explanation	Troubleshooting
(is displayed approx. every 3 seconds)			
<i>BUS no connection</i>	Online, no connection to the master.	Device is connected correctly to the bus, the network access procedure has ended without errors, however there is no established connection to the master.	<ul style="list-style-type: none"> • New connection established by master.
<i>BUS critical err</i>	Critical bus error.	Other device with the same address in the network. <i>BUS offline</i> due to communication problems.	<ul style="list-style-type: none"> • Change address of the device and restart device. • Fault analysis in the network with a bus monitor.

Table 59: Bus status display; Ethernet

MAN 1000341264 EN Version: F Status: RL (released | freigegeben) printed: 01.09.2023

19.5.1 Differences between the fieldbus devices and devices without a fieldbus

The following chapters of these operating instructions are not valid for Type 8792, 8793 with EtherNet.

- Section “Installation” chapter [“12 Electrical installation”](#)
- Section “Start-up” chapter [“14.2.1 INPUT - Setting the input signal”](#)
- Section “Auxiliary functions” chapter [“16.1.7 SPLTRNG – Signal split range”](#)
 chapter [“16.1.17 CAL.USER – Calibration of actual value and set-point value”](#)
 - menu option *calibr.INP*, calibration des set-point position
 - menu option *calibr.SP*, calibration of the process set-point
- chapter [“16.1.15 BINARY.IN – Activation of the digital input”](#)
- chapter [“16.1.16 OUTPUT – Configuration of the outputs \(option\)”](#)

19.5.2 BUS.COMM – Settings on Type 8792, 8793

Set the following menu options in the *BUS.COMM* menu for start-up of the EtherNet variant:

Activate or deactivate approach of the safety position

Selection – The actuator remains in the position which corresponds to the set-point value last transferred (default setting).

Selection – If there is a fault in the bus communication, the behavior of the actuator depends on the activation of the *SAFEPOS* auxiliary function. See chapter [“16.1.13 SAFEPOS – Inputting the safety position”](#).

SAFEPOS activated: The actuator moves to the safety position which is specified in the *SAFEPOS* auxiliary function.

SAFEPOS deactivated: The actuator moves to the safety end position which it would assume if the electrical and pneumatic auxiliary power failed. See chapter [“10.8 Safety end positions after failure of the electrical or pneumatic auxiliary power”](#)

Setting the fieldbus mode (from software version B.11.00.00, a device restart will be required after a change)

Selection – Suitable for use with device description files from version 2.00.

Selection – Compatibility mode with software version up to and including B.10.00.00

Activate or deactivate Object Route Function ORF (from software version B.11.00.00, a device restart will be required after a change)

Selection – No access to individual objects in the büS network (default setting).

Selection – Allows access to individual objects in the büS network (see document Fieldbus Description: Communication, running cyclical commands, access to büS objects)

20 BÜS OPTION

20.1 Definition

büS is a fieldbus which is based on CANopen with additional functionality for networking several devices.

20.2 Interfaces

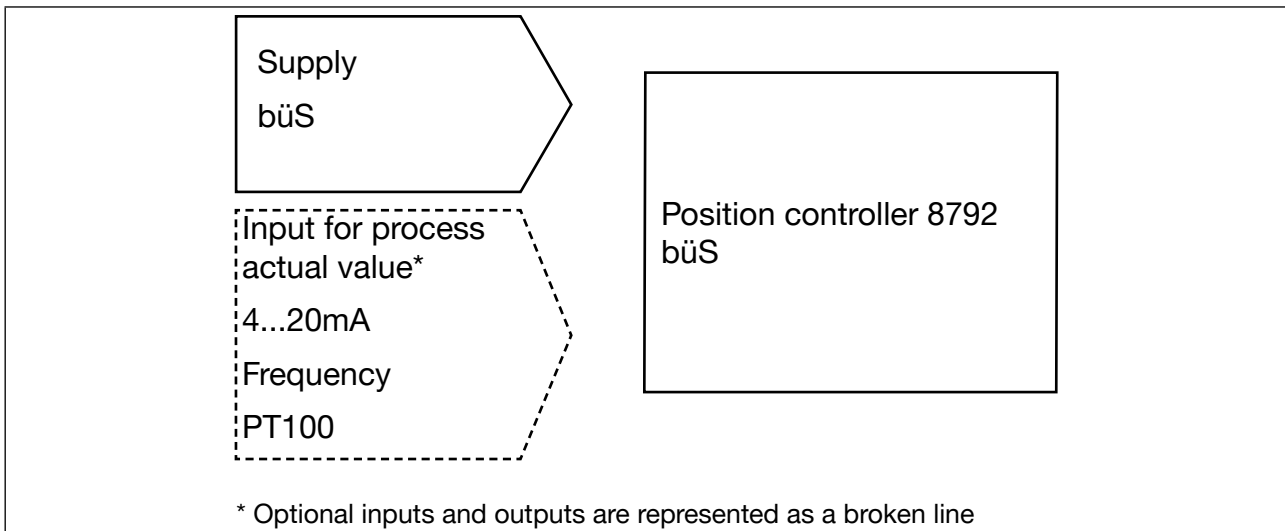

20.3 Electrical installation - büS

20.3.1 Safety instructions



DANGER

Risk of injury due to electric shock.

- ▶ Before reaching into the system, switch off the power supply and secure to prevent reactivation.
- ▶ Observe the applicable accident prevention regulations and safety regulations for electrical equipment.



WARNING

Risk of injury from improper installation.

- ▶ Installation may be carried out by authorized technicians only and with the appropriate tools.

Risk of injury due to unintentional switching on of the plant and uncontrolled start-up.

- ▶ Secure the device against accidental activation.
- ▶ Following installation, ensure a controlled restart.

20.4 Pin assignment

20.4.1 Connection diagram Type 8792

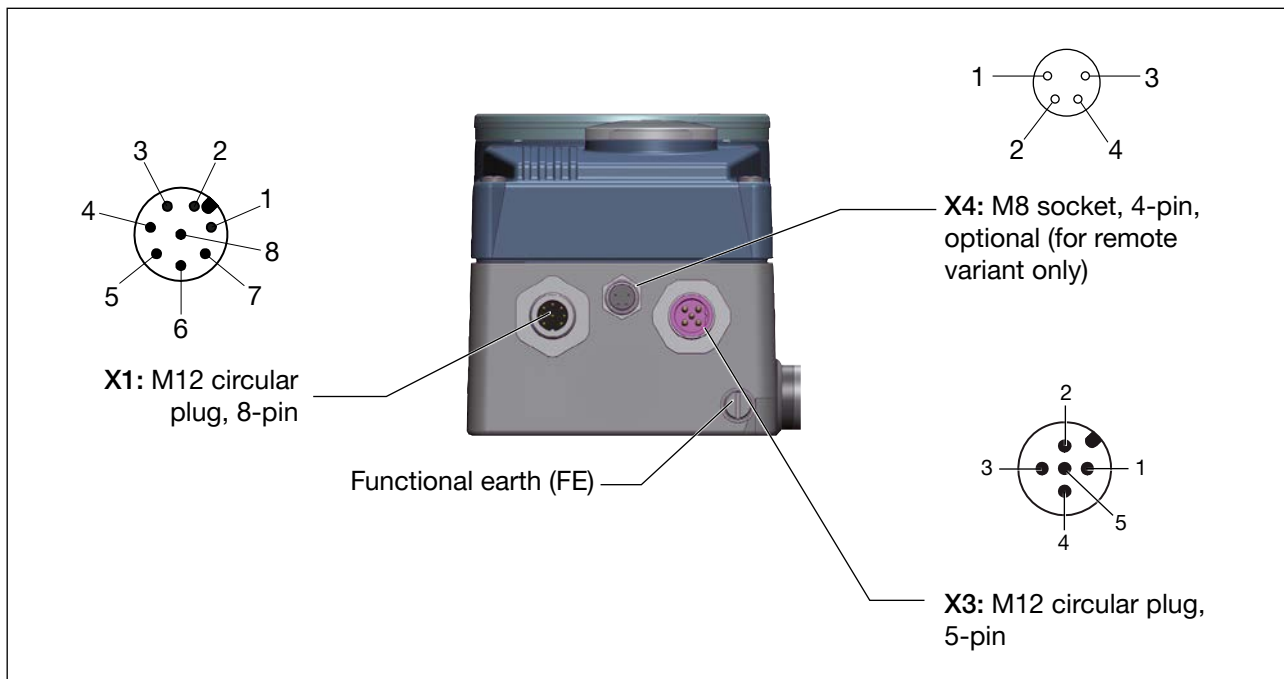

Figure 73: Connection diagram Type 8792

20.4.2 Connection diagram Type 8793

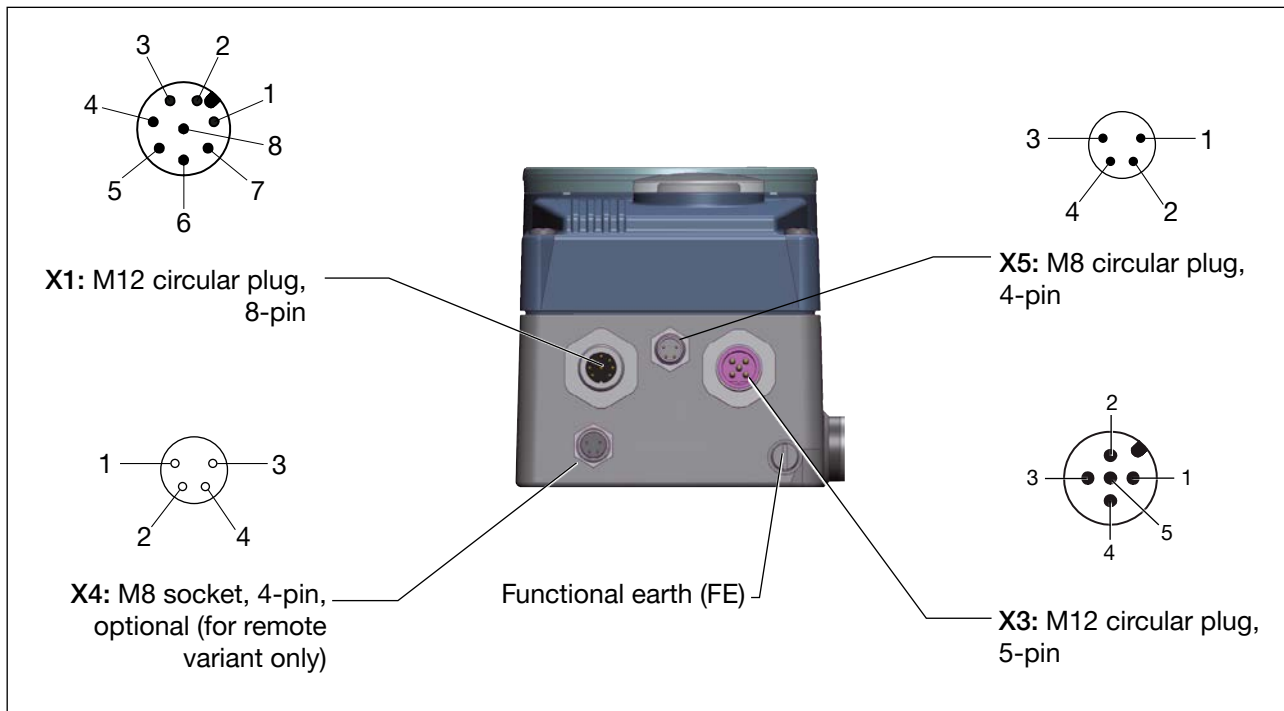

Figure 74: Connection diagram Type 8793

MAN 1000341264 EN Version: F Status: RL (released | freigegeben) printed: 01.09.2023

20.4.3 X1: M12 circular plug, 8-pin

Pin	Assignment	On the device side	External circuit / signal level
1	Not assigned		
2	Not assigned		
Operating voltage			
3	GND		24 V DC ±10 % max. residual ripple 10 %
4	+ 24 V		
Input signal of the control center (e.g. PLC)			
5	Digital input +		0...5 V (logical 0) 10...30 V (logical 1)
6	Digital input -		
Output signals to the control center (e.g. PLC) - (assigned for the digital output option only)			
7	Digital output 1 (referring to Pin 3)	7	0...24 V
8	Digital output 2 (referring to Pin 3)	8	0...24 V

Table 60: X1, M12 circular plug, 8-pin (operating voltage)

20.4.4 X3: circular plug-in connector M12x1, 5-pin

Pin	Wire color	Assignment
1	CAN shield	CAN shield
2	Not assigned	
3	Black	Black GND / CAN_GND
4	White	White CAN_H
5	Blue	Blue CAN_L

Table 61: Connection of the circular plug-in connector



Electrical installation with or without büS network:

To be able to use the büS network (CAN interface), a 5-pin circular plug and a shielded 5-wire cable must be used.

20.4.5 X4: M8 socket, 4-pin, optional - Remote sensor (for remote variant only)

Connection of the digital, non-contacting position sensor Type 8798:

Pin	Assignment	On the device side	External circuit
1	Supply sensor +	S +	
2	Supply sensor -	S -	
3	Serial interface, A cable	A	
4	Serial interface, B cable	B	

Table 62: Pin assignment; X4 - M8 socket, 4-pin - digital, non-contacting position sensor Type 8798

Connection of an analog, potentiometric position sensor:



Pin	Assignment	On the device side	External circuit
1	Potentiometer 1	1	
2	Sliding contact 2	2	
3	Potentiometer 3	3	
4	Not assigned		

Table 63: Pin assignment; X4 - M8 socket - 4-pin - analog, potentiometer-type position sensor

20.4.6 X5: M8 circular plug, 4-pin - Process actual value (for Type 8793)

Input type*	Pin	Wire color **	Assignment	DIP switches***	On the device side	External circuit
4 – 20 mA - internally supplied	1	brown	+24 V transmitter power supply			
	2	white	Output from transmitter			
	3	blue	GND (identical to GND operating voltage)			
	4	black	Bridge after GND (Pin 3)			
4 – 20 mA - externally supplied	1	brown	Not assigned			
	2	white	Process actual +			
	3	blue	Not assigned			
	4	black	Process actual -			
Frequency - internally supplied	1	brown	+24 V sensor power supply			
	2	white	Clock input +			
	3	blue	Clock input - (GND)			
	4	black	Not assigned			

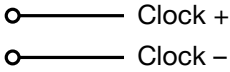
MAN 1000341264 EN Version: F Status: RL (released | freigegeben) printed: 01.09.2023

Input type*	Pin	Wire color **	Assignment	DIP switches***	On the device side	External circuit		
Frequency - externally supplied	1	brown	Not assigned	 Switch on right	2	 Clock +		
	2	white	Clock input +				3	Clock -
	3	blue	Clock input -					
	4	black	Not assigned					
Pt 100 (see information below)	1	brown	Not assigned	 Switch on right	2	 Pt 100		
	2	white	Pt 100 power supply				3	
	3	blue	Pt 100 GND				4	
	4	black	Pt 100 compensation					

* Can be adjusted via software (see chapter "14.2.1 INPUT - Setting the input signal")

** The indicated wire colors refer to the connection cable available as an accessory (92903474).

*** The switch is located inside the device on the printed circuit board (see "Figure 25: Location of the switch; symbols for switch position")

Table 64: Pin assignment; X5 - M8 circular plug, 4-pin - process actual value input



For reasons of wire compensation connect the Pt 100 sensor via 3 wires. Always bridge Terminal 3 and Terminal 4 on the sensor.

20.4.7 Switch position (only type 8793)

For the "internally supplied" input type, the GND signal of the process actual value must be connected to the GND signal of the operating voltage. A bridge is established internally between both GND signals using the "left" switch position.

Supplied	Assignment	Switch position
Internally supplied	GND process actual value equal to GND operating voltage	Switch on left
Externally supplied	GND process actual value electrically isolated from GND operating voltage	Switch on right

Table 65: Switch position

20.5 BUS.COMM – Settings on Type 8792, 8793

Set the following menu options in the *BUS.COMM* menu for start-up of the EtherNet variant:

BUS FAIL Activate or deactivate approach of the safety position

Selection **SafePos off** – The actuator remains in the position which corresponds to the set-point value last transferred (default setting).

Selection **SafePos on** – If there is a fault in the bus communication, the behavior of the actuator depends on the activation of the *SAFEPOS* auxiliary function. See chapter "16.1.13 *SAFEPOS* – Inputting the safety position".

SAFEPOS activated: The actuator moves to the safety position which is specified in the *SAFEPOS* auxiliary function.

SAFEPOS deactivated: The actuator moves to the safety end position which it would assume if the electrical and pneumatic auxiliary power failed.
See chapter “[10.8 Safety end positions after failure of the electrical or pneumatic auxiliary power](#)”

BUS.COMM is set as follows:

→  Press **MENU** for 3 s. Switching from process level ⇔ setting level.

▲ / ▼ Select *BUS.COMM*. Selection in the main menu (MAIN).

→  Select **ENTER**. The submenu options for basic settings can now be selected.

Setting device address:

(for bÜS devices the address is automatically set)

→ ▲ / ▼ Select address.

→  Select **INPUT**. The input screen is opened.

→ ▲ / ▼  Increase value or  reduce value. Enter a device address (value between 0 and 127).

→  Select **OK**. Return to *BUS.COMM*.

Select baud rate:

→ ▲ / ▼ Select *BAUD RATE*.

→  Select **ENTER**. The input screen is opened.

→ ▲ / ▼ Select *BAUD RATE*. 50 kBd / 125 kBd / 250 kBd / 500 kBd / 1000 kBd

→  Select **SELECT**. The selection is now marked by a filled circle ●.

→  Select **EXIT**. Return to *BUS.COMM*.

✔ You have set *BUS.COMM*.



With bÜS devices not only the bÜS service interface but also the Bürkert-Communicator can be connected directly to the bÜS network.

21 PROFIBUS DPV1

21.1 Technical data

The protocol sequence complies with the standard DIN 19245 Part 3.

Type 8792:

GSD file	BUER1173.GSD
Bitmap file	BUER1173.BMP
PNO-ID.	0x1173

Type 8793:

GSD file	BUER1174.GSD
Bitmap file	BUER1174.BMP
PNO-ID.	0x1174

Baud rate	Max. 12 Mbaud (is automatically set by the Type 8792/8793)
-----------	---

Sync and Freeze mode	Are supported
----------------------	---------------

Diagnostic telegramm	No device-specific
----------------------	--------------------

Diagnostic parameter telegramm	No user parameters
--------------------------------	--------------------

The process data is configured in the PROFIBUS DP master

21.2 Interfaces

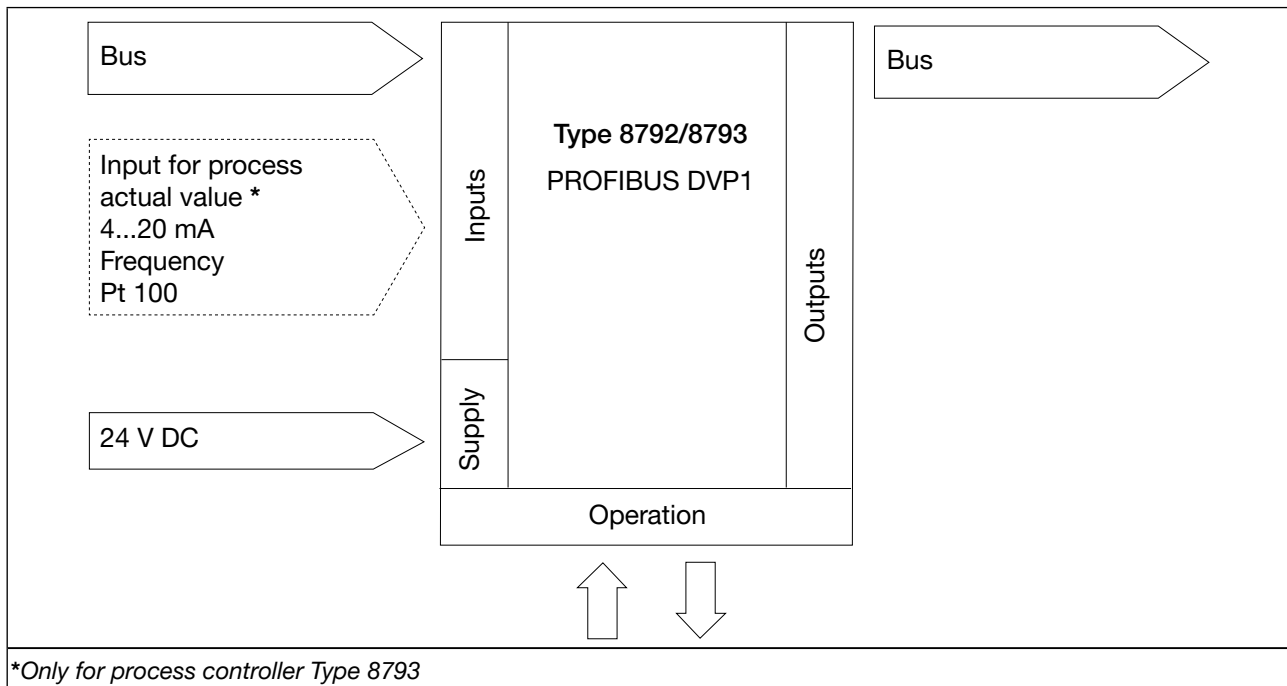

Figure 75: Interfaces PROFIBUS DVP1

21.3 Differences between the fieldbus devices and devices without a fieldbus

The following chapters of these operating instructions are not valid for Type 8792, 8793 with PROFIBUS DPV1.

- Section “Installation” chapter [“12 Electrical installation”](#)
- Section “Start-up” chapter [“14.2.1 INPUT - Setting the input signal”](#)
- Section “Auxiliary functions” chapter [“16.1.7 SPLTRNG – Signal split range”](#)
- chapter [“16.1.17 CAL.USER – Calibration of actual value and set-point value”](#)
 - menu option *calibr.INP*, calibration des set-point position
 - menu option *calibr.SP*, calibration of the process set-point
- chapter [“16.1.15 BINARY.IN – Activation of the digital input”](#)
- chapter [“16.1.16 OUTPUT – Configuration of the outputs \(option\)”](#)

21.4 Electrical connections

DANGER!

Risk of injury due to electrical shock.

- ▶ Before reaching into the device or the equipment, switch off the operating voltage and secure to prevent reactivation.
- ▶ Observe applicable accident prevention and safety regulations for electrical equipment.

WARNING!

Risk of injury from improper installation.

- ▶ Installation may be carried out by authorized technicians only and with the appropriate tools.

Risk of injury from unintentional activation of the system and an uncontrolled restart.

- ▶ Secure system from unintentional activation.
- ▶ Following installation, ensure a controlled restart.

NOTE!

Electromagnetic compatibility (EMC) is only ensured if the appliance is connected correctly to an earthing point.

On the outside of the housing is a FE terminal for connection of the functional earth (FE).

- ▶ Connect the FE terminal to the earthing point via a shortest possible cable (maximum length 30 cm).

21.4.1 Connection diagram Type 8792

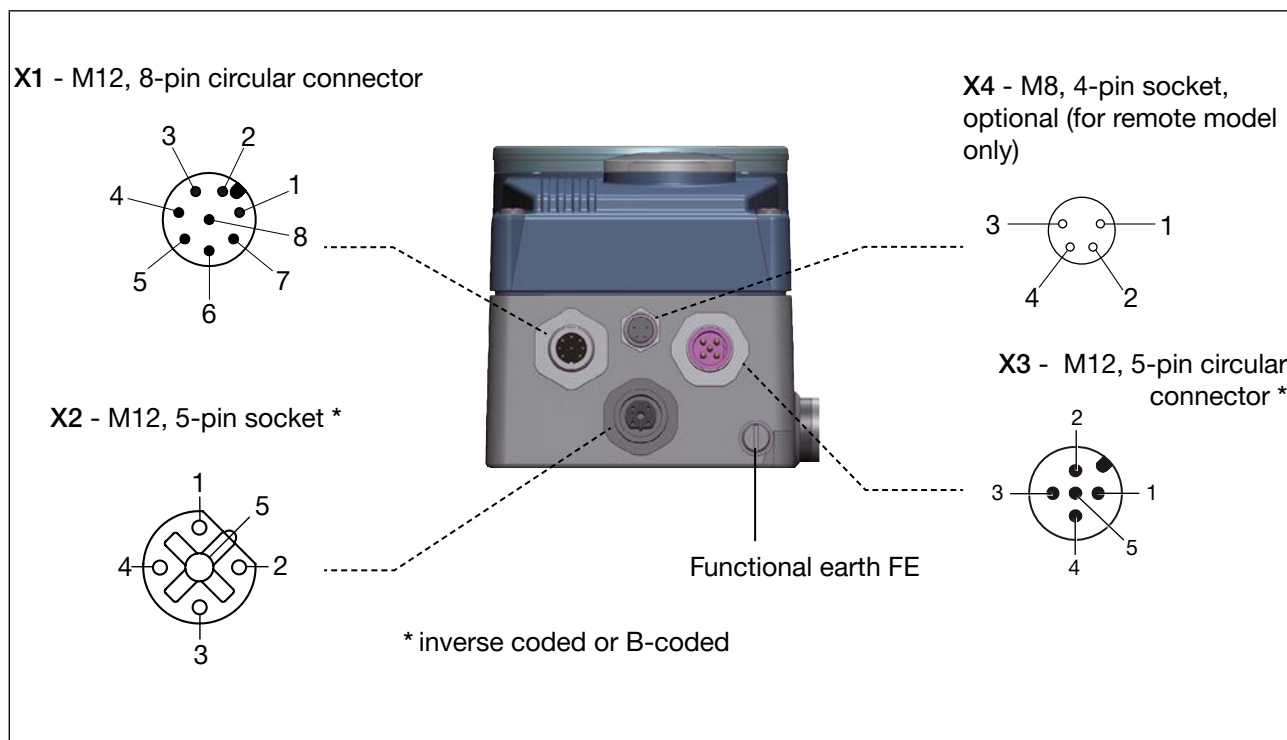

Figure 76: Connection PROFIBUS DPV1, positioner Type 8792

21.4.2 Connection diagram Type 8793

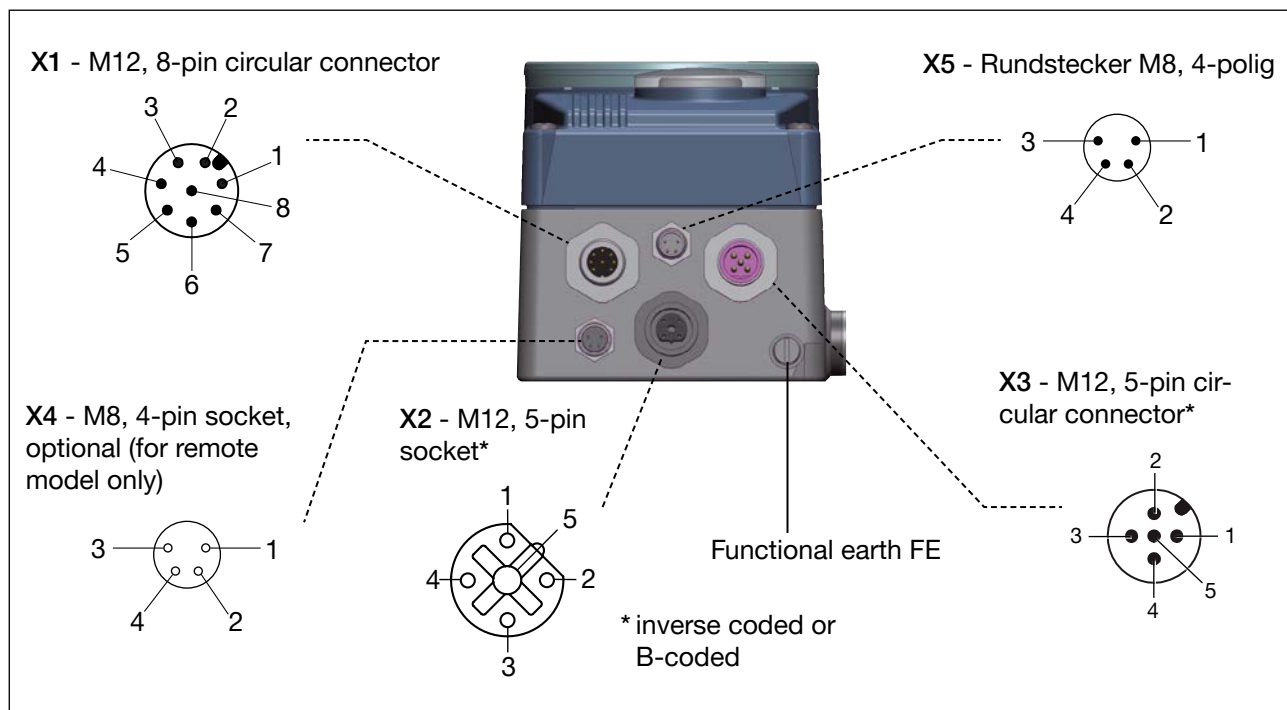

Figure 77: Connection PROFIBUS DPV1, positioner Type 8793

MAN 1000341264 EN Version: F Status: RL (released | freigegeben) printed: 01.09.2023

21.4.3 X1 - M12, 8-pin circular connector

Pin	Configuration	On the device side	External circuit / Signal level
1	not used		
2	not used		
Operating voltage			
3	GND	3	<p>24 V DC \pm 10 % max. residual ripple 10 %</p>
4	+24 V	4	
Input signals of the control centre (e.g. PLC)			
5	Digital input +	5	<p>0...5 V (log. 0) 10...30 V (log. 1) GND (identical with Pin 3)</p>
6	Digital input -	6	
Output signals to the control centre (e.g. PLC) - (only used for digital output option)			
7	Digital output 1 (referring to Pin 3)	7	0...24 V
8	Digital output 2 (referring to Pin 3)	8	0...24 V

Table 66: Pin assignment; X1 - M12, 8-pin circular connector; PROFIBUS DPV1

21.4.4 X2, X3 - M12, 5-pin socket/circular connector, bus connection

Pin	Configuration	External circuit / Signal level
1	VP+5	Supply the terminating resistors
2	RxD/TxD-N	Received/transmitted data -N, A-line
3	DGND	Data transmission potential (earth to 5 V)
4	RxD/TxD-P	Received/transmitted data -P, B-line
5	Schirm	Shielding / protective earth

Table 67: Pin assignment; X2/X3 - M12, 5-pin circular connector/socket - bus connection, PROFIBUS DPV1

21.4.5 4-pin socket, optional - Remote Sensor (for remote variant only)

Connection of the digital, contact-free position sensor Type 8798:

Pin	Configuration	On the device side	External circuit
1	Supply sensor +	S + ○ ——— +	
2	Supply sensor -	S - ○ ——— -	
3	Serial interface, A cable	A ○ ——— A cable	
4	Serial interface, B cable	B ○ ——— B cable	

Table 68: Plug assignments; X4 - M8, 4-pin socket - digital, contact-free position sensor Type 8798

Connection of an analog, potentiometric position sensor:



Pin	Configuration	On the device side	External circuit
1	Potentiometer 1	1 ○ ———	
2	Wiper 2	2 ○ ———	
3	Potentiometer 3	3 ○ ———	
4	not used		

Table 69: Plug assignments; X4 - M8, 4-pin socket - analog, potentiometric position sensor

21.4.6 X5: M8 circular plug, 4-pin - Process actual value (for Type 8793)

Input type*	Pin	Wire color **	Assignment	DIP switches***	On the device side	External circuit
4 – 20 mA - internally supplied	1	brown	+24 V transmitter power supply			
	2	white	Output from transmitter			
	3	blue	GND (identical to GND operating voltage)			
	4	black	Bridge to GND (Pin 3)			
4 – 20 mA - externally supplied	1	brown	Not assigned			
	2	white	Process actual +			
	3	blue	Not assigned			
	4	black	Process actual -			

MAN 1000341264 EN Version: F Status: RL (released | freigegeben) printed: 01.09.2023

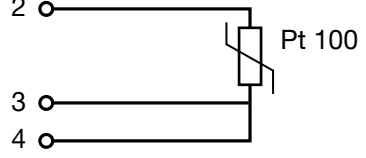
Input type*	Pin	Wire color **	Assignment	DIP switches***	On the device side	External circuit
Frequency - internally supplied	1	brown	+24 V sensor power supply	 Switch on left	1	+24 V
	2	white	Clock input +		2	Clock +
	3	blue	Clock input - (GND)		3	Clock - GND (identical to GND operating voltage)
	4	black	Not assigned			
Frequency - externally supplied	1	brown	Not assigned	 Switch on right	2	Clock +
	2	white	Clock input +		3	Clock -
	3	blue	Clock input -			
	4	black	Not assigned			
Pt 100 (see information below)	1	brown	Not assigned	 Switch on right	2	
	2	white	Pt 100 power supply			
	3	blue	Pt 100 GND			
	4	black	Pt 100 compensation			

* Can be adjusted via software (see chapter "14.2.1 INPUT - Setting the input signal")

** The indicated wire colors refer to the connection cable available as an accessory (92903474).

*** The switch is located inside the device on the printed circuit board (see "Figure 25: Location of the switch; symbols for switch position")

Table 70: Pin assignment; X5 - M8 circular plug, 4-pin - process actual value input



For reasons of wire compensation connect the Pt 100 sensor via 3 wires. Always bridge Terminal 3 and Terminal 4 on the sensor.

21.5 Start-up PROFIBUS DPV1

21.5.1 Safety instructions



WARNING!

Risk of injury from improper operation.

Improper operation may result in injuries as well as damage to the device and the area around it

- ▶ Before start-up, ensure that the operating personnel are familiar with and completely understand the contents of the operating instructions.
- ▶ Observe the safety instructions and intended use.
- ▶ Only adequately trained personnel may start up the equipment/the device.

21.5.2 Start-up sequence

For start-up of Type 8792/8793 PROFIBUS DPV1 the following basic settings are required:

Device type	Sequence	Type of basic setting	Setting via	Description in chapter
8792 and 8793	1	Adjust device to the local conditions	<i>X.TUNE</i>	"14.2.2"
For 8793 only (Process control)	2	Activate process controller	<i>ADD.FUNCTION</i>	"14.3"
8792 and 8793	3	Settings on Type 8792/8793: Input device address.	<i>BUS.COMM</i>	"21.5.4"
	4	Activate or deactivate safety position.		
	5	Configuration via the control (PROFIBUS DP Master): Configuration of the process values 1. PDI: Process data input 2. PDO: Process data output.	PROFIBUS DP Master mittels GSD-Datei und spezieller Software	

Table 71: Start-up sequence for PROFIBUS DPV1

21.5.3 Safety settings if the bus fails

The position is approached which corresponds to the set-point value last transferred (default setting).

Other setting options (see chapter ["21.5.4 BUS.COMM – Settings on Type 8792, 8793"](#))

21.5.4 BUS.COMM – Settings on Type 8792, 8793

Set the following menu options in the *BUS.COMM* menu for start-up of the PROFIBUS DPV1 variant:

Baudrate Auto Set transmission speed (9.6 kBit/s...12 MBit/s)

Note: A device restart will be required after a change.

Address 126 Enter a device address (value between 0 and 126)

BUS FAIL Activate or deactivate approach of the safety position

Selection **SafePos off** – The actuator remains in the position which corresponds to the set-point value last transferred (default setting).

Selection **SafePos on** – If there is a fault in the bus communication, the behavior of the actuator depends on the activation of the *SAFEPOS* auxiliary function. See chapter “16.1.13 *SAFEPOS* – Inputting the safety position”.

SAFEPOS activated: The actuator moves to the safety position which is specified in the *SAFEPOS* auxiliary function.

SAFEPOS deactivated: The actuator moves to the safety end position which it would assume if the electrical and pneumatic auxiliary power failed. See chapter “10.8 Safety end positions after failure of the electrical or pneumatic auxiliary power”

Object Route Fct Activate or deactivate Object Route Function ORF (from software version B.11.00.00,

Selection **Off** – No access to individual objects in the bÜS network (default setting).

Selection **On** – Allows access to individual objects in the bÜS network (see document Fieldbus Description: Communication, running cyclical commands, access to bÜS objects)

21.6 Bus status display

The bus status is indicated on the display on the device.

Display	Device status	Explanation	Troubleshooting
BUS offline is displayed approx. every 3 seconds	offline	Device is not connected to the bus	<ul style="list-style-type: none"> • Check bus connection including plug assignment. • Check operating voltage and bus connection of the other nodes.

Table 72: Bus status display; PROFIBUS DPV1

22 MAINTENANCE AND TROUBLESHOOTING

22.1 Safety instruction

WARNING

Risk of injury due to incorrect maintenance work.

- ▶ Maintenance may be carried out only by trained technicians and with the appropriate tools.
- ▶ Secure the device against accidental activation.
- ▶ Ensure controlled start-up after maintenance.

22.2 Maintenance

If these instructions are followed for operation, Type 8792/8793 is maintenance-free.

22.3 Error messages



Display	Causes of error	Remedy
	Minimum input value has been reached.	Do not reduce value further.
	Maximum input value has been reached.	Do not increase value further.
<i>CMD error</i>	Signal fault Set-point value positioner (position controller).	Check signal.
<i>SP error</i>	Signal fault Set-point value process controller.	Check signal.
<i>PV error</i>	Signal fault Actual value process controller.	Check signal.
<i>PT100 error</i>	Signal fault Actual value Pt 100.	Check signal.
<i>invalid code</i>	Incorrect access code.	Enter correct access code.
<i>EEPROM fault</i>	EEPROM defective.	Not possible, replace device.
<i>Puck weak</i>	Puck signal too weak.	Check that the puck is mounted correctly and sitting on the guide rail.
<i>WMS error</i>	Position sensor is not detected. Position sensor defective.	Check the wiring of the position sensor. Not possible, replace position sensor or device.

Table 73: General error messages

22.3.1 Error and warning messages while the X.TUNE function is running

Display	Causes of error	Remedy
TUNE err/break	Manual termination of self-optimization by pressing the EXIT key.	
X.TUNE locked	The X.TUNE function is blocked.	Enter access code.
X.TUNE ERROR 1	No compressed air connected.	Connect compressed air.
X.TUNE ERROR 2	Compressed air failure while Autotune (X.TUNE) is running.	Check compressed air supply.
X.TUNE ERROR 3	Actuator or control system deaeration side leaking.	Not possible, device defective.
X.TUNE ERROR 4	Control system aeration side leaking.	Not possible, device defective.
X.TUNE ERROR 5	The rotation range of the position sensor has exceeded 180°.	Correct attachment of the position sensor shaft to the actuator (see chapter “11.2” and “11.3”).
X.TUNE ERROR 6	The end positions for POS-MIN and POS-MAX are too close together.	Check compressed air supply.
X.TUNE ERROR 7	Incorrect assignment POS-MIN and POS-MAX.	To determine POS-MIN and POS-MAX , move the actuator in the direction indicated on the display.
X.TUNE WARNING 1**	Potentiometer is not coupled optimally to the actuator. An optimum connection can provide a more accurate position measurement.	Set the center position as described in chapter “11.2.4 Aligning the lever mechanism”.

** Warning information gives tips for optimized operation. The device is operational even if this warning information is not observed. Warning information is automatically hidden after several seconds.

Table 74: Error and warning message on X.TUNE

22.3.2 Error messages while running the *P.Q'LIN* function

Display	Causes of error	Remedy
<i>TUNE</i> <i>err/break</i>	Manual termination of self-optimization by pressing the EXIT key.	
<i>P.Q LIN</i> <i>ERROR 1</i>	No compressed air connected. No change to process variable.	Connect compressed air. Check process and, if required, switch on pump or open the shut-off valve. Check process sensor.
<i>P.Q LIN</i> <i>ERROR 2</i>	Current node of the valve stroke was not reached, as <ul style="list-style-type: none"> • Compressed air failure during <i>P.Q'LIN</i>. • Autotune (<i>X.TUNE</i>) was not run. 	Check compressed air supply. Run Autotune (<i>X.TUNE</i>).

Table 75: Error message for *P.Q'LIN*; process controller Type 8793

22.3.3 Error messages while the *P.TUNE* function is running

Display	Causes of error	Remedy
<i>TUNE</i> <i>err/break</i>	Manual termination of self-optimization by pressing the EXIT key.	
<i>P.TUNE</i> <i>ERROR 1</i>	No compressed air connected. No change to process variable.	Connect compressed air. Check process and, if required, switch on pump or open the shut-off valve. Check process sensor.

Table 76: Error message for *P.TUNE*; process controller Type 8793

For Ethernet/IP, PROFINET, Modbus TCP, PROFIBUS DPV1

Display (is displayed approx. every 3 seconds)	Device state	Explanation	Troubleshooting
<i>BUS no connection</i>	Online, no connection to the master.	Device is connected correctly to the bus, the network access procedure has ended without errors, however there is no established connection to the master.	<ul style="list-style-type: none"> • New connection established by master.
<i>BUS critical err</i>	Critical bus error.	Other device with the same address in the network. <i>BUS offline</i> due to communication problems.	<ul style="list-style-type: none"> • Change address of the device and restart device. • Fault analysis in the network with a bus monitor.

Table 77: Error message Ethernet/IP, PROFINET, Modbus TCP, PROFIBUS DPV1

For BUES device

Display (is displayed approx. every 3 seconds)	Device state	Explanation	Troubleshooting
<i>BUS no connection</i>	Online, no connection to the master.	Device is connected correctly to the bus, the network access procedure has ended without errors, however there is no established connection to the master.	<ul style="list-style-type: none"> • New connection established by master.
<i>BUS critical err</i>	Critical bus error.	Other device with the same address in the network. <i>BUS offline</i> due to communication problems.	<ul style="list-style-type: none"> • Change address of the device and restart device. • Fault analysis in the network with a bus monitor.
<i>Partner not found</i>	Partner not found	A configured partner (Producer) cannot be found.	<ul style="list-style-type: none"> • Check that the configured partner is switched on and connected to the bus network. • Check the bus mapping using the Communicator.

Table 78: Error message BUES device

22.4 Malfunctions

Problem	Possible causes	Remedy
<p>$POS = 0$ (when $CMD > 0\%$) or $POS = 100\%$, (when $CMD < 100\%$).</p> <p>$PV = 0$ (when $SP > 0$) or $PV = PV$ (when $SP > SP$).</p>	Sealing function (<i>CUTOFF</i>) is unintentionally activated.	Deactivate sealing function.
<p>Applies only to devices with digital output:</p> <p>Digital output does not switch.</p>	<p>Digital output:</p> <ul style="list-style-type: none"> • Current > 100 mA • Short circuit 	Check digital output connection.
<p>Applies only to devices with process controller:</p> <p>Device is not operating as a controller, despite correctly implemented settings.</p>	<i>P.CONTROL</i> menu option is in the main menu. The device is therefore operating as a process controller and expects a process actual value at the corresponding input.	Remove <i>P.CONTROL</i> menu option from the main menu. See chapter “16.1.2 Removing auxiliary functions from the main menu” on page 89.

Table 79: Other malfunctions

23 ACCESSORIES

Accessories	Order number
Connection cable with M12 socket, 8-pin, (length 5 m)	919267
Connection cable with M12 socket, 4-pin, (length 5 m)	918038
Connection cable with M8 socket , 4-pin, (length 5 m)	92903474
Connection cable with M12 circular plug, 4-pin, (length 5 m) D-coded	On request
USB büS interface set:	
büS service interface (büS stick + +0.7 m cable with M12 plug)	772551
büS adapter for büS service interface (M12 to büS service interface micro USB)	773254
büS cable extensions from M12 plug to M12 socket	
Connection cable, length 1 m	772404
Connection cable, length 3 m	772405
Connection cable, length 5 m	772406
Connection cable, length 10 m	772407
Bürkert Communicator	Information at www.burkert.com

Table 80: Accessories

23.1 Communication software

The PC operating program “Bürkert Communicator” is designed for communication with Bürkert devices.



A detailed description for installing and operating the software can be found in the associated operating instructions.

Download the software from: www.burkert.com

23.2 USB interface

The PC requires a USB interface for communication with the devices, also a USB-büS interface set (see “Table 80: Accessories”).

Data is transmitted according to CANopen specification.

24 PACKAGING, TRANSPORT

NOTE

Transport damage.

Inadequately protected devices may be damaged during transportation.

- ▶ Protect the device against moisture and dirt in shock-resistant packaging during transportation.
- ▶ Prevent the temperature from exceeding or dropping below the permitted storage temperature.

25 STORAGE

NOTE

Incorrect storage may damage the device.

- ▶ Store the device in a dry and dust-free location.
- ▶ Storage temperature -20 to +65 °C.

26 DISPOSAL



- ▶ Follow national regulations regarding disposal and the environment.
- ▶ Collect electrical and electronic devices separately and dispose of them as special waste.

Further information [country.burkert.com](https://www.burkert.com).

27 SUPPLEMENTARY INFORMATION

27.1 Selection criteria for continuous valves

The following criteria are crucial for optimum control behavior and to ensure that the required maximum flow is reached:

- the correct selection of the flow coefficient which is defined primarily by the orifice of the valve;
- close coordination between the valve orifice and the pressure conditions in consideration of the remaining flow resistance in the equipment.

Design guidelines can be given on the basis of the flow coefficient (k_v value). The k_v value refers to standardized conditions regarding pressure, temperature and media properties.

The k_v value describes the flow rate of water through a component in m^3/h at a pressure difference of $\Delta p = 1 \text{ bar}$ and $T = 20 \text{ }^\circ\text{C}$.

The “ k_{vs} -value” is additionally used for continuous valves. This indicates the k_v value when the continuous valve is fully open.

Depending on the specified data, it is necessary to differentiate between the two following cases when selecting the valve:

- a) The pressure values p_1 and p_2 , known before and after the valve, represent the required maximum flow rate Q_{max} which is to be reached:

The required k_{vs} -value is calculated as follows:

$$k_{vs} = Q_{\text{max}} \cdot \sqrt{\frac{\Delta p_0}{\Delta p}} \cdot \sqrt{\frac{\rho}{\rho_0}} \quad (1)$$

With:

- k_{vs} flow coefficient of the continuous valve at full opening [m^3/h]
- Q_{max} max. volumetric flow rate [m^3/h]
- $\Delta p_0 = 1 \text{ bar}$; pressure loss on the valve according to the definition of the k_v value
- $\rho_0 = 1000 \text{ kg/m}^3$; density of water (according to the definition of the k_v value)
- Δp pressure loss on the valve [bar]
- ρ density of the medium [kg/m^3]

b) The pressure values, known at the input and output of the entire equipment (p_1 and p_2), at which the desired maximum flow rate Q_{\max} shall be reached:

- 1st step: Calculate the flow coefficient of the entire equipment $k_{v\text{total}}$ according to equation (1).
- 2nd step: Determine the flow rate through the equipment without the continuous valve (e.g. by “bypassing” the line at the installation location of the continuous valve).
- 3rd step: Calculate the flow coefficient of the equipment without the continuous valve (k_{va}) according to equation (1).
- 4th step: Calculate the required k_{vs} -value of the continuous valve according to equation (2):

$$k_{vs} = \sqrt{\frac{1}{\frac{1}{k_{v\text{ges}}^2} - \frac{1}{k_{va}^2}}} \quad (2)$$



The k_{vs} -value of the continuous valve should have at least the value which is calculated according to equation (1) or (2) which is appropriate to the application, however it should never be far above the calculated value.

The rule of thumb “slightly higher is never harmful” often used for switching valves may greatly impair the control behavior of continuous valves.

The upper limit for the k_{vs} -value of the continuous valve can be specified in practice via the so-called valve authority Ψ :

$$\Psi = \frac{(\Delta p)_{vo}}{(\Delta p)_o} = \frac{k_{va}^2}{k_{va}^2 + k_{vs}^2} \quad (3)$$

$(\Delta p)_{vo}$ Pressure drop over the fully opened valve

$(\Delta p)_o$ Pressure drop over the entire equipment



If the valve authority $\Psi < 0.3$ the continuous valve has been oversized.

When the continuous valve is fully open, the flow resistance in this case is significantly less than the flow resistance of the remaining fluid components in the equipment. This means that the valve position predominates in the operating characteristic in the lower opening range only. For this reason the operating characteristic is highly deformed.

By selecting a progressive (equal percentage) transfer characteristic between position set-point value and valve stroke, this can be partially compensated and the operating characteristic linearized within certain limits. However, the valve authority Ψ should be > 0.1 even if a correction characteristic is used.

The control behavior (control quality, transient time) depends greatly on the operating point if a correction characteristic is used.

27.2 Properties of PID controllers

A PID controller has a proportional, an integral and a differential portion (P, I and D portion).

27.2.1 P portion

Function:

$$Y = K_p \cdot X_d$$

K_p is the proportional coefficient (amplification factor). It is the ratio of the adjustment range ΔY and the proportional range ΔX_d .

Characteristic and step response of the P portion of a PID controller

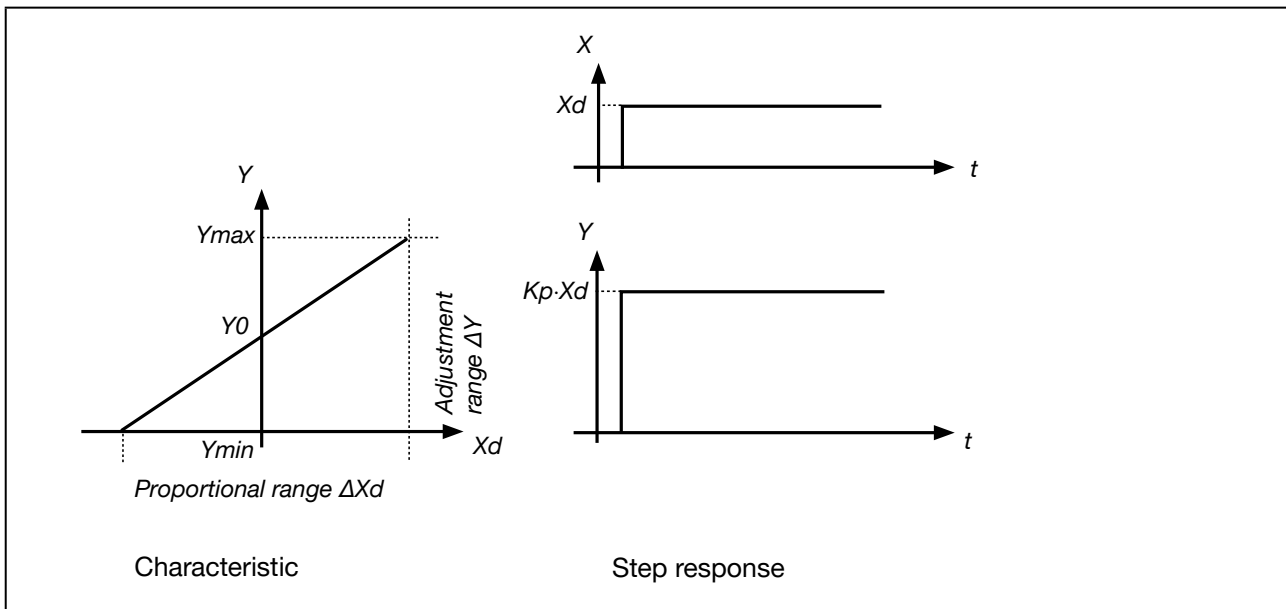

Figure 78: Characteristic and step response of the P portion of a PID controller

Properties

In theory a pure P-controller functions instantaneously, i.e. it is quick and therefore dynamically favorable. It has a constant control difference, i.e. it does not fully correct the effects of malfunctions and is therefore statically relatively unfavorable.

27.2.2 I portion

Function:

$$Y = \frac{1}{T_i} \int X \, dt \quad (5)$$

T_i is the integral action time or actuating time. It is the time which passes until the actuating variable has run through the whole adjustment range.

Characteristic and step response of the I portion of a PID controller

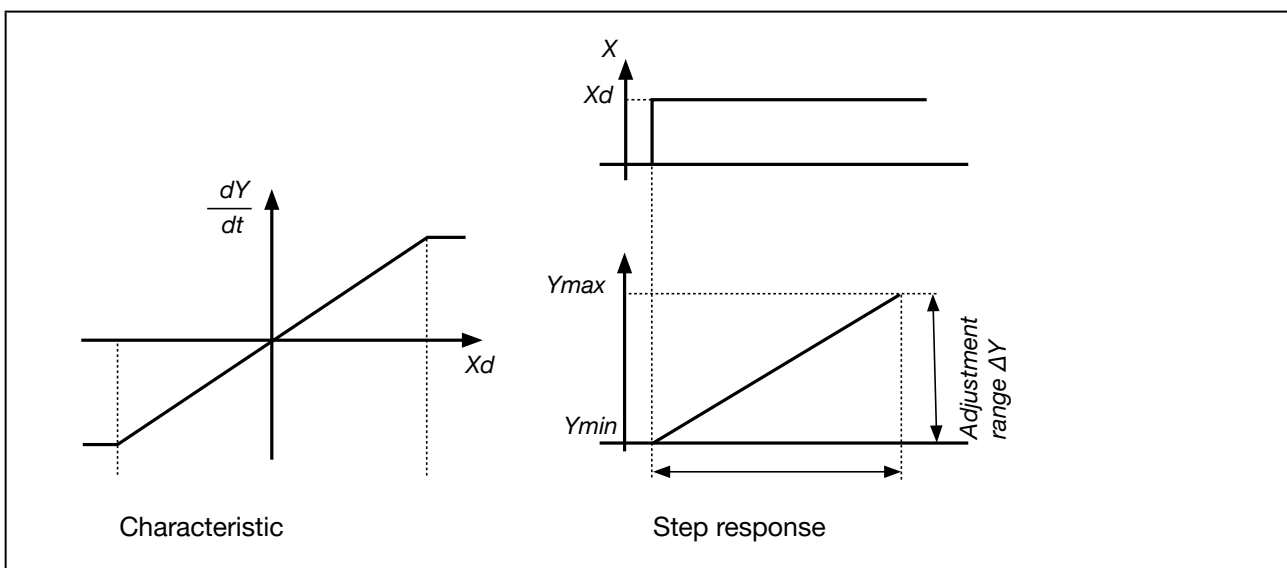

Figure 79: Characteristic and step response of the I portion of a PID controller

Properties

A pure I-controller completely eliminates the effects of any malfunctions which occur. It therefore has a favorable static behavior. On account of its final control speed control it operates slower than the P-controller and has a tendency to oscillate. It is therefore dynamically relatively unfavorable.

27.2.3 D portion

Function:

$$Y = K_d \cdot \frac{dX}{dt} \quad (6)$$

K_d is the derivative action coefficient. The larger K_d is, the greater the D-effect is.

Characteristic and step response of the D portion of a PID controller

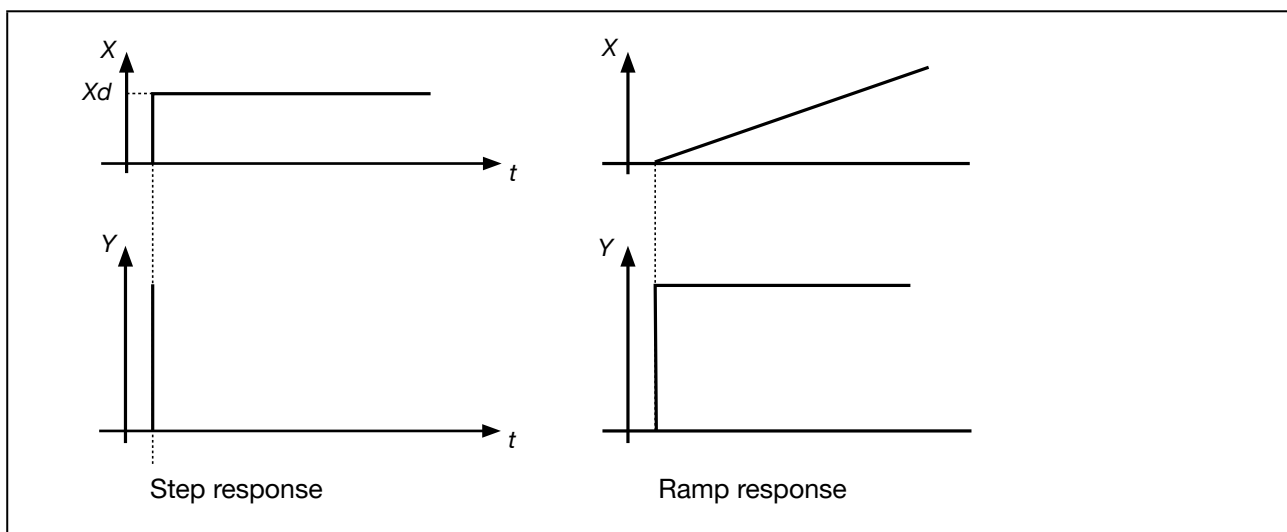

Figure 80: Characteristic and step response of the D portion of a PID controller

Properties

A controller with a D portion responds to changes in the control variable and may therefore reduce any control differences more quickly.

27.2.4 Superposition of P, I and D portions

Function:

$$Y = K_p \cdot X_d + \frac{1}{T_i} \int X_d dt + K_d \frac{dX_d}{dt} \quad (7)$$

Where $K_p \cdot T_i = T_n$ and $K_d/K_p = T_v$ the **function of the PID controller** is calculated according to the following equation:

$$Y = K_p \cdot \left(X_d + \frac{1}{T_n} \int X_d dt + T_v \frac{dX_d}{dt} \right) \quad (8)$$

- K_p Proportional coefficient / amplification factor
- T_n Reset time
 (Time which is required to obtain an equally large change in the actuating variable by the I portion, as occurs due to the P portion)
- T_v Derivative time
 (Time by which a certain actuating variable is reached earlier on account of the D portion than with a pure P controller)

Step response and ramp response of the PID controller

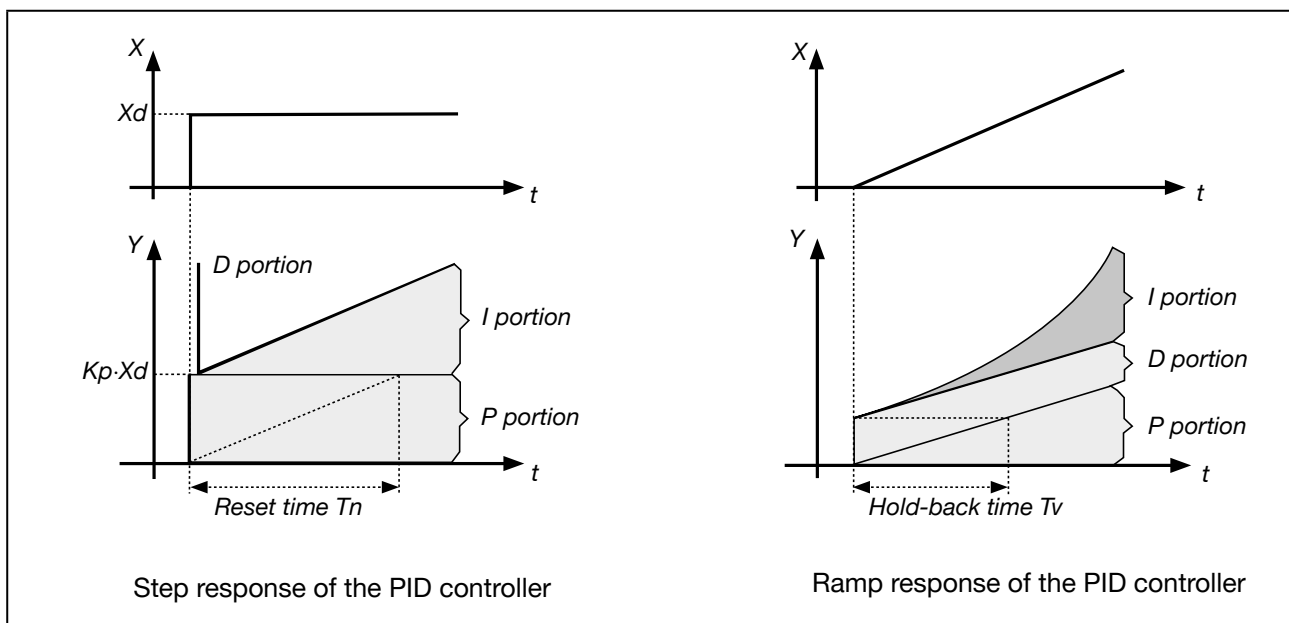

Figure 81: Characteristic of step response and ramp response of PID controller

MAN 1000341264 EN Version: F Status: RL (released | freigegeben) printed: 01.09.2023

27.2.5 Implemented PID controller

27.2.5.1. D portion with delay

In the process controller of the Type 8793 positioner the D portion is implemented with a delay T.

Function:

$$T \cdot \frac{dY}{dt} + Y = K_d \cdot \frac{dX_d}{dt} \quad (9)$$

Superposition of P, I and DT portions

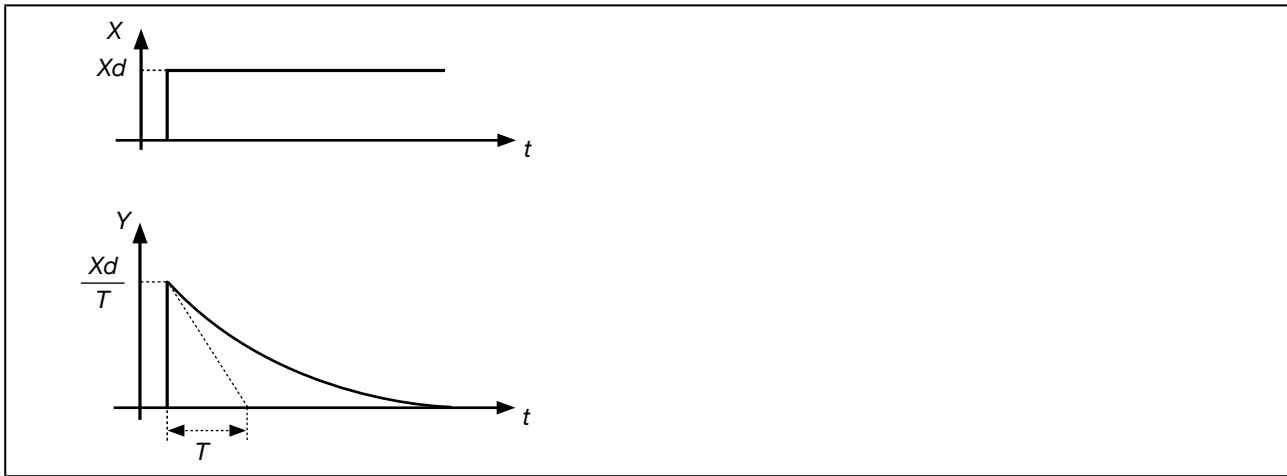

Figure 82: Characteristic of superposition of P, I and DT portions

27.2.5.2. Function of the real PID controller

$$T \cdot \frac{dY}{dt} + Y = K_p \left(X_d + \frac{1}{T_n} \int X_d dt + T_v \frac{dX_d}{dt} \right) \quad (10)$$

Superposition of P, I and DT portions

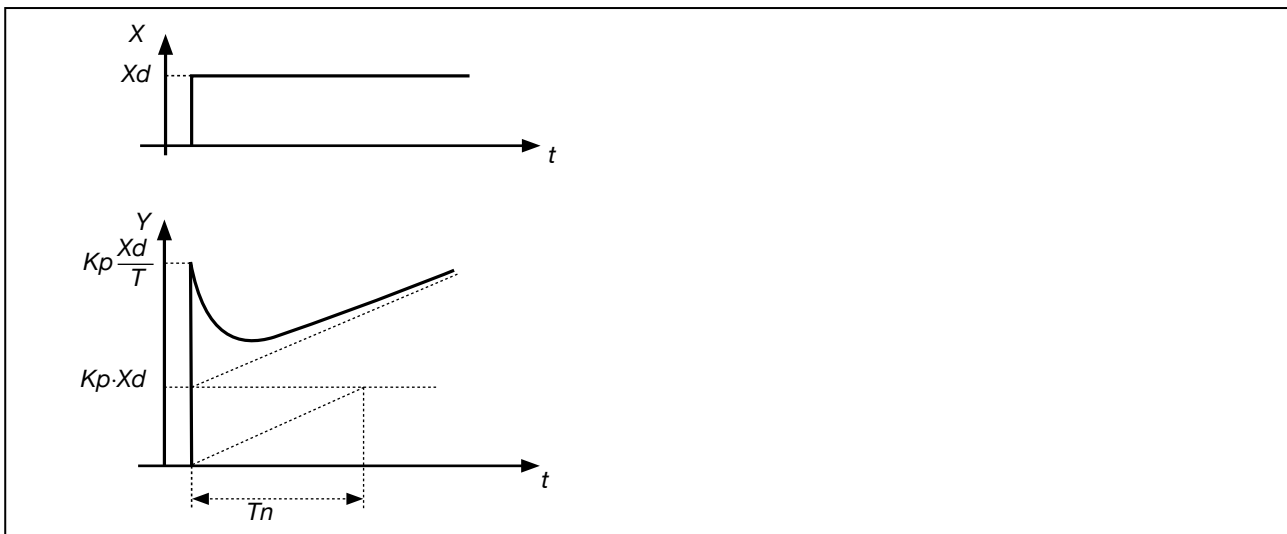

Figure 83: Characteristic of step response of the real PID controller

27.3 Adjustment rules for PID controllers

The Type 8793 control system comes with a self-optimization function for the structure and parameters of the integrated process controller. The PID parameters determined can be viewed via the operating menu and empirically re-optimized as desired.

The regulatory literature includes a series of adjustment rules which can be used in experimental ways to determine a favorable setting for the controller parameters. To avoid incorrect settings, always observe the conditions under which the particular adjustment rules have been drawn up. Apart from the properties of the controlled system and the controller itself, the aspect whether a change in the disturbance variable or command variable is to be corrected plays a role.

27.3.1 Adjustment rules according to Ziegler and Nichols (oscillation method)

With this method the controller parameters are adjusted on the basis of the behavior of the control circuit at the stability limit. The controller parameters are first adjusted so that the control circuit starts to oscillate. The occurring critical characteristic values suggest a favorable adjustment of the controller parameters. A prerequisite for the application of this method of course is that the control circuit may be oscillated.

Procedure

- Set controller as P-controller (i.e. $T_n = 999$, $T_v = 0$), first select a low value for K_p
- Set required set-point value
- Increase K_p until the control variable initiates an undamped continuous oscillation.

The proportionality coefficient (amplification factor) set at the stability limit is designated as K_{crit} . The resulting oscillation duration is designated as T_{crit} .

Progress of the control variable at the stability limit

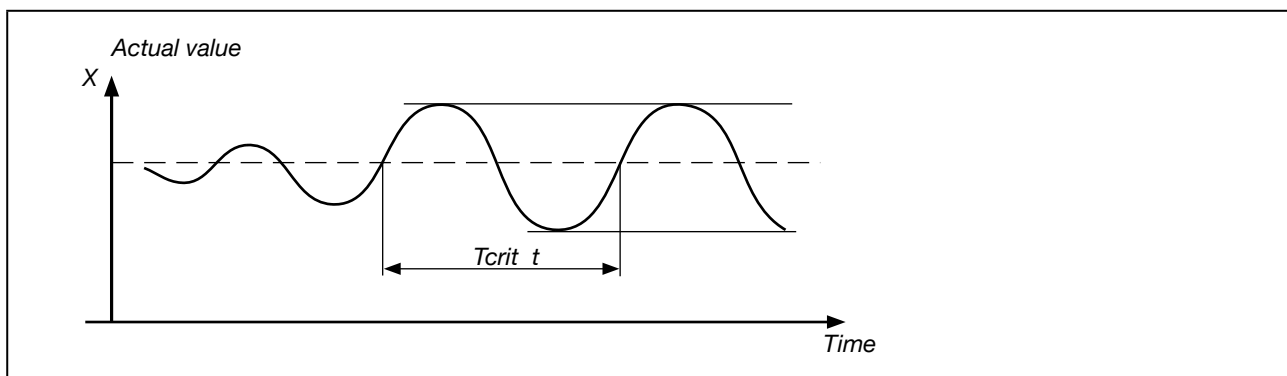

Figure 84: Progress of the control variable PID

The controller parameters can then be calculated from K_{crit} and T_{crit} according to the following table.

Setting the parameters according to Ziegler and Nichols

Controller type	Setting the parameters		
P controller	$K_p = 0.5 K_{crit}$	-	-
PI controller	$K_p = 0.45 K_{crit}$	$T_n = 0.85 T_{crit}$	-
PID controller	$K_p = 0.6 K_{crit}$	$T_n = 0.5 T_{crit}$	$T_v = 0.12 T_{crit}$

Table 81: *Setting the parameters according to Ziegler and Nichols*

The adjustment rules of Ziegler and Nichols have been determined for P-controlled systems with a time delay of the first order and dead time. However, they apply only to controllers with a disturbance reaction and not to those with a reference reaction.

27.3.2 Adjustment rules according to Chien, Hrones and Reswick (Actuating Variable Jump Method)

With this method the controller parameters are adjusted on the basis of the transient behavior of the controlled system. An actuating variable jump of 100% is output. The times T_u and T_g are derived from the progress of the actual value of the control variable.

Progress of the control variable following an actuating variable jump ΔY

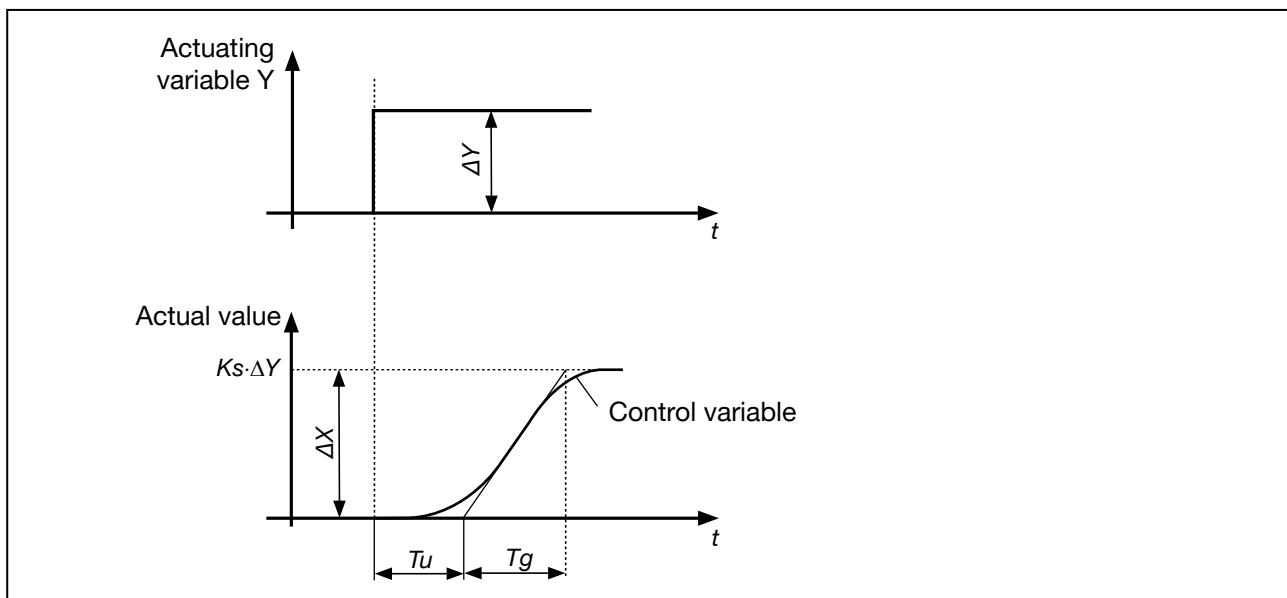

Figure 85: Progress of the control variable, actuating variable jump

Procedure

- Switch controller to MANUAL (MANU) operating state
- Output the actuating variable jump and record control variable with a recorder
- If progresses are critical (e.g. danger of overheating), switch off promptly.



Note that in thermally slow systems the actual value of the control variable may continue to rise after the controller has been switched off.

In the following “[Table 82](#)” the set values have been specified for the controller parameters, depending on T_u , T_g and K_s for reference and disturbance reaction, as well as for an aperiodic control process and a control process with a 20% overshoot. They apply to controlled systems with P-behavior, with dead time and with a delay of the first order.

Setting the parameters according to Chien, Hrones and Reswick

Controller type	Setting the parameters			
	for aperiodic control process (0% overshoot)		for control process with 20% overshoot	
	Reference	Malfunction	Reference	Malfunction
P controller	$K_p = 0.3 \cdot \frac{T_g}{T_u \cdot K_s}$	$K_p = 0.3 \cdot \frac{T_g}{T_u \cdot K_s}$	$K_p = 0.7 \cdot \frac{T_g}{T_u \cdot K_s}$	$K_p = 0.7 \cdot \frac{T_g}{T_u \cdot K_s}$
PI controller	$K_p = 0.35 \cdot \frac{T_g}{T_u \cdot K_s}$ $T_n = 1.2 \cdot T_g$	$K_p = 0.6 \cdot \frac{T_g}{T_u \cdot K_s}$ $T_n = 4 \cdot T_u$	$K_p = 0.6 \cdot \frac{T_g}{T_u \cdot K_s}$ $T_n = T_g$	$K_p = 0.7 \cdot \frac{T_g}{T_u \cdot K_s}$ $T_n = 2.3 \cdot T_u$
PID controller	$K_p = 0.6 \cdot \frac{T_g}{T_u \cdot K_s}$ $T_n = T_g$ $T_v = 0.5 \cdot T_u$	$K_p = 0.95 \cdot \frac{T_g}{T_u \cdot K_s}$ $T_n = 2.4 \cdot T_u$ $T_v = 0.42 \cdot T_u$	$K_p = 0.95 \cdot \frac{T_g}{T_u \cdot K_s}$ $T_n = 1.35 \cdot T_g$ $T_v = 0.47 \cdot T_u$	$K_p = 1.2 \cdot \frac{T_g}{T_u \cdot K_s}$ $T_n = 2 \cdot T_u$ $T_v = 0.42 \cdot T_u$

Table 82: Setting the parameters according to Chien, Hrones and Reswick

The proportionality factor K_s of the controlled system is calculated as follows:

$$K_s = \frac{\Delta X}{\Delta Y} \quad (11)$$

28 TABLE FOR YOUR SETTINGS ON THE POSITIONER

28.1 Settings of the freely programmed characteristic

Node (position set-point value as%)	Valve stroke [%]			
	Date:	Date:	Date:	Date:
0				
5				
10				
15				
20				
25				
30				
35				
40				
45				
50				
55				
60				
65				
70				
75				
80				
85				
90				
95				
100				

MAN 1000341264 EN Version: F Status: RL (released | freigegeben) printed: 01.09.2023

