



## Superior tank cleaning for industrial environments

### Alfa Laval GJ 4

#### Application

The Alfa Laval GJ 4 is part of the world-renowned Gamajet range of high impact tank cleaning devices. The device provides high-impact cleaning for large-sized tanks with diameters over 4.6 m (15'). This device is fully capable of high-concentration chemical recirculation cleaning and high-pressure, low-volume water jet scrubbing in fixed, automated CIP systems. The Alfa Laval GJ 4 is designed to remove the toughest residues from large tanks in numerous industries and is customizable in a wide variety of ways. The Alfa Laval GJ 4 allows companies to spend less time cleaning and more time producing.

#### Working principle

The Gamajet range of high impact tank cleaning devices combine pressure and flow to create high impact cleaning jets. Cleaning occurs at the point at which the concentrated stream impacts the surface. It is this impact and the tangential force that radiates from that point which blasts contaminants from the surface, scouring the tank interior. In conjunction with this impact, the device is engineered to rotate in a precise, repeatable and reliable, 360° pattern. This full-coverage, global indexing pattern ensures the entire tank interior is cleaned, every time.



#### TECHNICAL DATA

Lubricant . . . . . Food grade  
Max. throw length . . . . . 30.5 m (100 ft.)

#### Pressure

Working pressure . . . . . 3 - 21 bar (40 - 300 PSI)  
Recommended pressure . . . . . 3.5 - 14 bar (50 - 200 PSI)

#### Cleaning Pattern

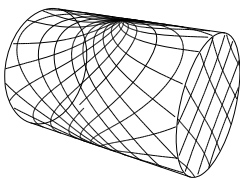

First Cycle

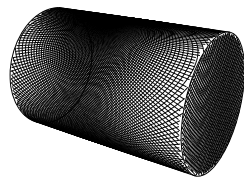

Full Pattern

The above drawings show the cleaning pattern achieved on a cylindrical horizontal vessel. The difference between the first cycle and the full pattern represents the number of additional cycles available to increase the density of the cleaning.

#### Certificate

2.1 material certificate

#### PHYSICAL DATA

##### Materials

1.4404 (316L), PPS, FKM (EPDM and FFKM available)

##### Temperature

Max. working temperature . . . . . 95°C (203°F)  
Max. ambient temperature . . . . . 140°C (284°F)

##### Weight

. . . . . 12.7 - 13.2kg (28 - 29 lbs.)

##### Connections

Standard thread . . . . . 2" NPT, 2" BSP

##### Options

Electronic rotation sensor to verify 3D coverage. 180° and 105° directional version available.

##### Caution

Do not use for gas evacuation or air dispersion.



Disclaimer: Information in this product data leaflet is intended for general guidance purposes. Specific data for device selection and sizing is available upon request.

**Flow Rate**

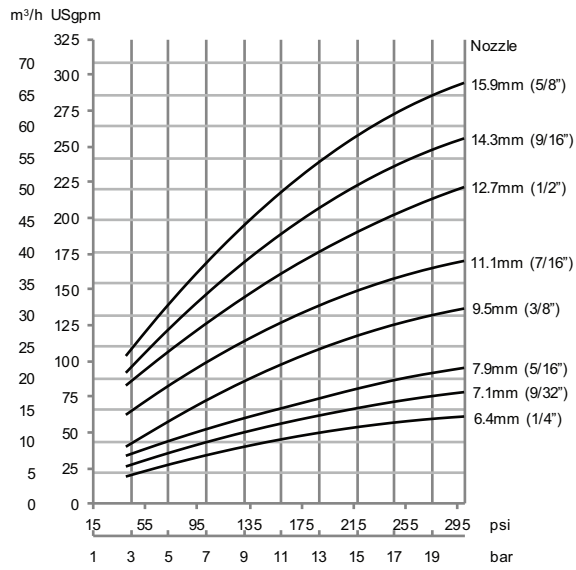

Inlet pressure

**Impact Throw Length**

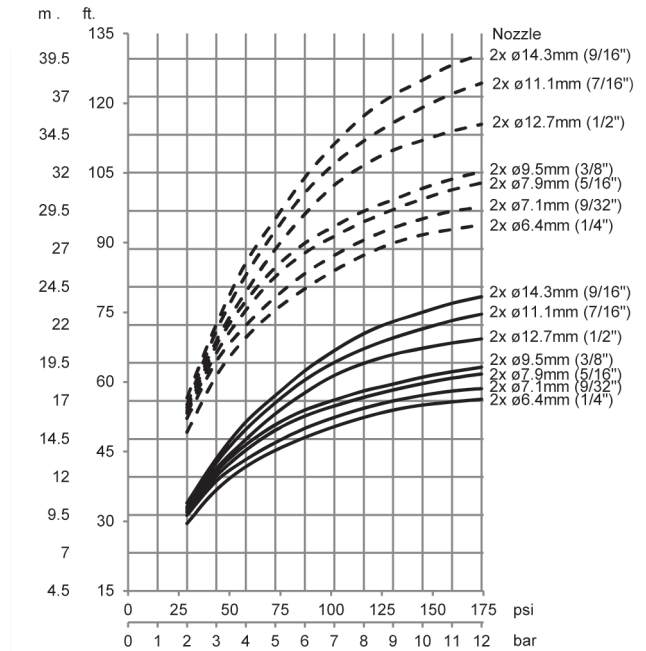

Inlet pressure

- - - Wetting, — Impact cleaning

**Cleaning Time (Gear Ratio 655:1)**

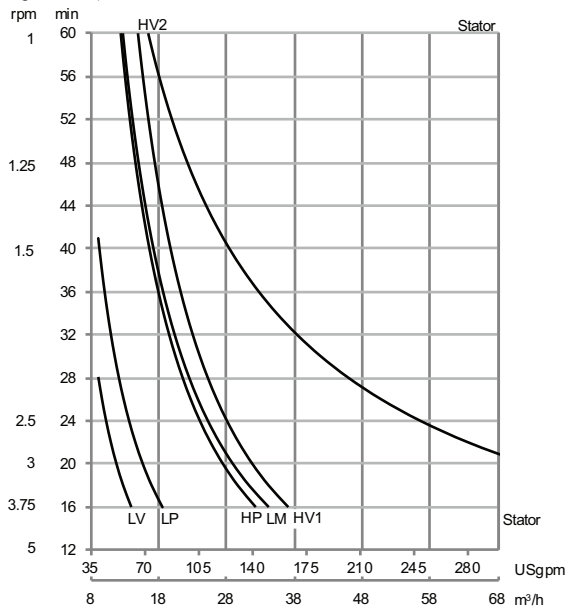

**Cleaning Time (Gear Ratio 273:1)**

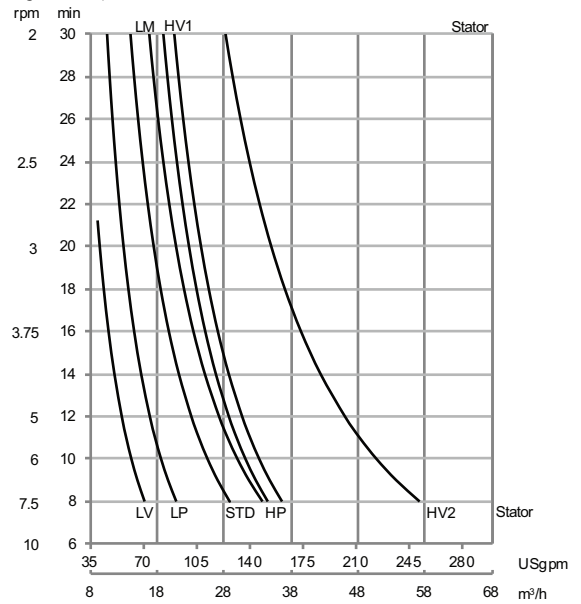

Dimensions

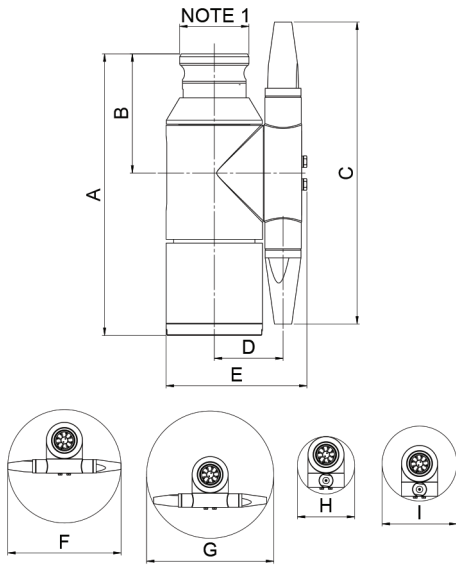

Dimensions

	A	B	C	D	E	F	G	H	I
mm	308	131	331	76	155	331	372	168	219
in	12.13	5.14	13	2.97	6.07	13.03	14.62	6.59	8.61

NOTE 1: 2" NPT FEMALE/ 2-1/2" CAMLOCK. 2" NPT FEMALE/ 2-1/2" NST

### Standard Design

The choice of nozzle diameters can optimize jet impact length and flow rate at the desired pressure. As standard documentation, the Alfa Laval GJ 4 can be supplied with a "Declaration of Conformity" for material specifications.

### TRAX simulation tool

TRAX is a unique software that simulates how the Alfa Laval GJ 4 performs in a specific tank or vessel. The simulation gives information on wetting intensity, pattern mesh width and cleaning jet velocity. This information is used to determine the best location of the tank cleaning device and the correct combination of flow, time, and pressure to implement.

A TRAX demo containing different cleaning simulations covering a variety of applications can be used as a reference and documentation for tank cleaning applications. The TRAX demo is free and available upon request.

### Wetting Intensity

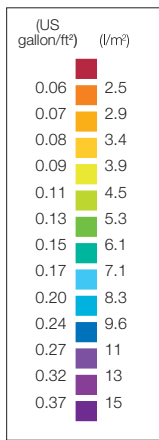

TD 523-208

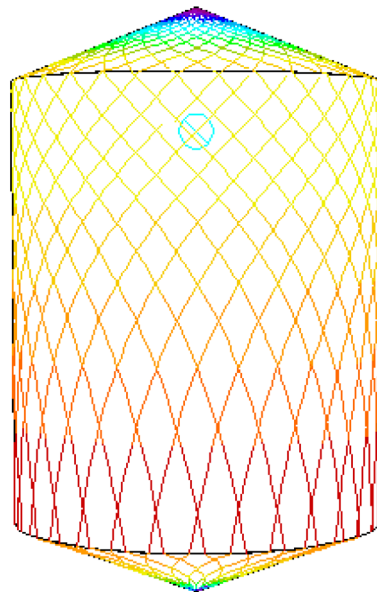

D21.3m (840"), H34m (1,340"), 2xØ11.11mm (2xØ7/16")  
Time = 6 min.

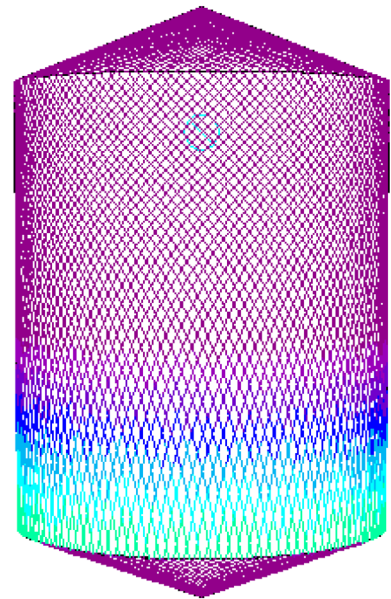

D21.3m (840"), H34m (1,340"), 2xØ11.11mm (2xØ7/16")  
Time = 24 min.

Alfa Laval reserves the right to change specifications without prior notification. ALFA LAVAL is a trademark registered and owned by Alfa Laval Corporate AB.



**CSI**

417.831.1411  
csidesigns.com