

The Cleanest Design

SRC Sanitary Remote-Controlled Valve

PD 60019 US8 2001-10

Application

SRC is an air-operated seat valve with a sanitary and flexible design giving a wide field of application, e.g. as a stop valve with two or three ports or as divert valve with three to five ports.

Working principle

The valve is remote-controlled by means of compressed air. It has few and simple moveable parts which results in a very reliable valve.

Standard design

SRC consists of an actuator, bonnet, lip seal, plug, stem and valve bodies. All components are assembled by means of sanitary clamps and a stem clip-system.

Actuator function

- Pneumatic downward movement, spring return (NO).
- Pneumatic upward movement, spring return (NC).
- Pneumatic upward and downward movement (A/A).
- Actuator for intermediate position of the valve plug as option

Other valves in the same basic design:

- Air operated seat valve, type 361.
- Air operated seat valve, type 761.
- Aseptic Remote controlled valve, type ARC.
- Sanitary Long Stroke valve, type SRC-LS.
- Sanitary Manual valve, type SMO.
- Sanitary Manual regulating valve, type SMO-R.
- Sanitary Manual valve, type SRC-BC.
- Sanitary Manual valve, type SMO-R, SMO-RA.



Fig. 1. SRC valve with 7 body and ThinkTop®.

Valve body combinations

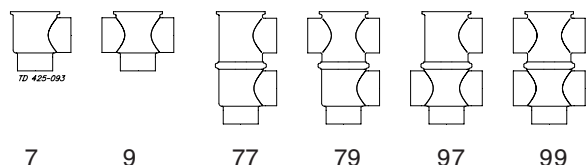

Pressure drop/capacity diagrams

Shut-off valve

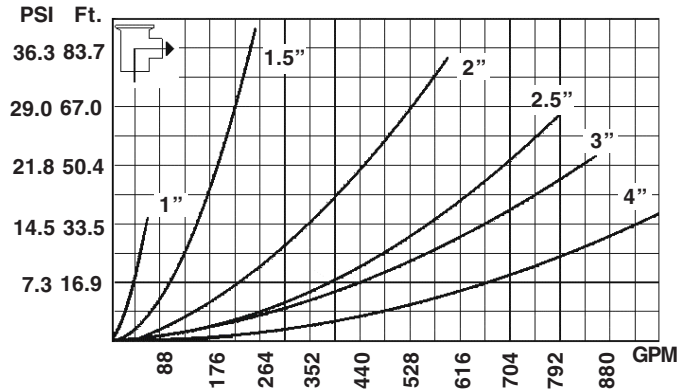
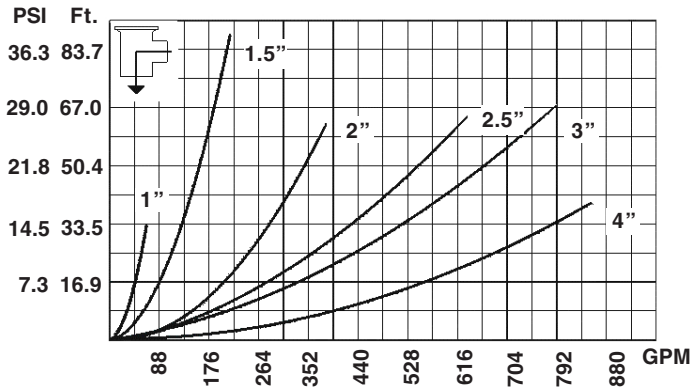

Divert valve

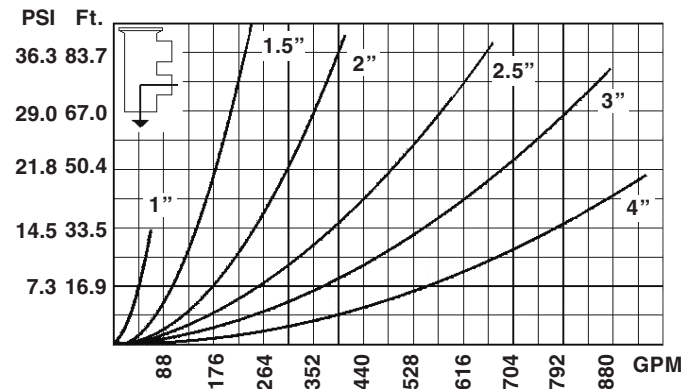
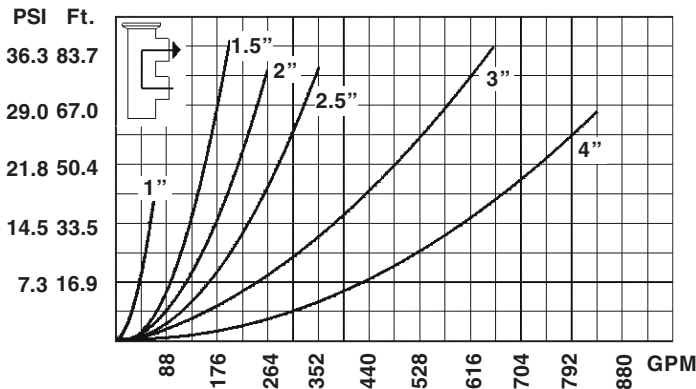
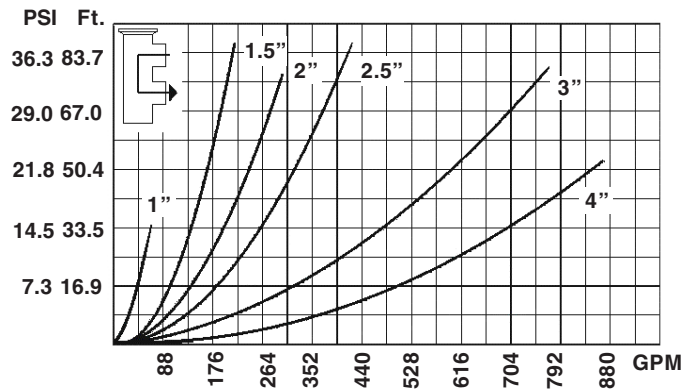
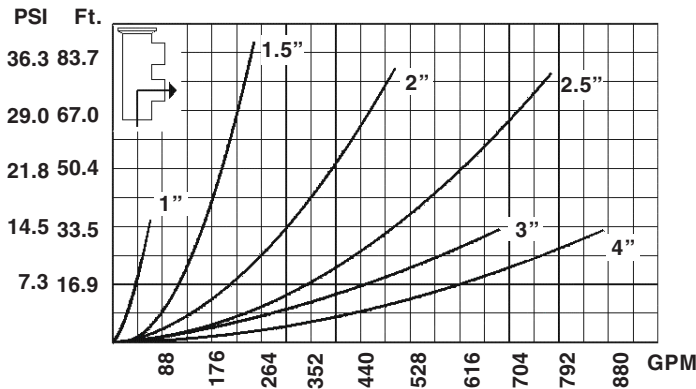







Note! For the diagrams the following applies:
 Medium: Water (68°F).
 Measurement: In accordance with VDI 2173.

Pressure data for SRC

Actuator type / function

- 10. Pneumatic downward movement, spring return (NO-lower seat).
- 20. Pneumatic upward movement, spring return (NC-lower seat).
- 30. Pneumatic upward and downward movement (A/A).
- 60. Three-positions (NO-lower seat).
- 70. Three-positions (NC-lower seat).

Table 1: Stop and divert valves
- Max. pressure without leakage at the valve seat

Actuator/Valve body combination and direction of pressure	Air Pressure (PSI)	Actuator/type	Valve Size					
			1-inch	1.5-inch	2-inch	2.5-inch	3-inch	4-inch
 Spring to close		10 (NO) 60 (NO)	137	65	65	44	72	50
 Air to close	72 87	10 (NO) 10 (NO)	Min. 145	100 145	58 80	44 58	58 87	36 58
 Air to close	72 87	20 (NC) 70 (NC)	137 Min. 145	65 95	65 95	44 58	65 100	36 58
 Spring to close		20 (NC) 70 (NC)	Min. 145	100	58	36	72	50
 Air to close	72 87	30 (A/A)	Min. 145	130 145	130 145	116 145	145 145	108 145
 Air to close	72 87	30 (A/A)	Min. 145	145 145	130 145	87 145	145 145	108 130



 = Values are valid for air pressure of 87 PSI.

 = Actual product pressure.

Pressure data for SRC

Table 2: Stop and Divert valves - Max. pressure for opening

The table shows the approx. static pressure (P) in PSI against which the valve can open.

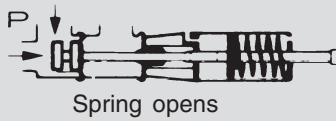
Actuator/Valve body combination and direction of pressure	Air Pressure (PSI)	Actuator/ type	Valve Size					
			1-inch	1.5-inch	2-inch	2.5-inch	3-inch	4-inch
 <p>Spring opens</p>		10 (NO) 60 (NO)	Min 145	130	87	58	108	72
 <p>Air opens</p>	87	10 (NO) 60 (NO)	Min 145	108	108	80	130	87
 <p>Air opens</p>	87	20 (NO) 70 (NO)	Min. 145	145	108	72	130	87
 <p>Spring opens</p>		20 (NO) 70 (NO)	Min. 145	87	87	72	108	72





 = Values are valid for air pressure of 116 PSI

 = Actual product pressure

 = Do not use 87 PSI air pressure

Pressure data for SRC

Table 3: Stop and Divert valves with extra strong springs or special cylinder
 - Max. pressure (PSI) without leakage at the valve seat

Actuator/Valve body combination and direction of pressure	Air Pressure (PSI)	Actuator/type	Valve Size						Special Actuator Valve Size				
			1-inch	1.5-inch	2-inch	2.5-inch	3-inch	4-inch	1.5-inch	2-inch	2.5-inch		
 Spring closes		10 (NO)	Min 145	94	94						130	87	
 Air closes	72 87	10 (NO)	33 145	29 29	0 29						145 ^	123 ^	87 ^
 Air closes	72 87	20 (NC)	58 117	0 29	0						130 ^	130 ^	87 ^
 Spring closes		20 (NC)	Min. 145	130	79						145	130	87

= Values are valid for air pressure of 116 PSI

 = Actual product pressure

^ = Do not use 87 PSI air pressure

Dimensions (in)

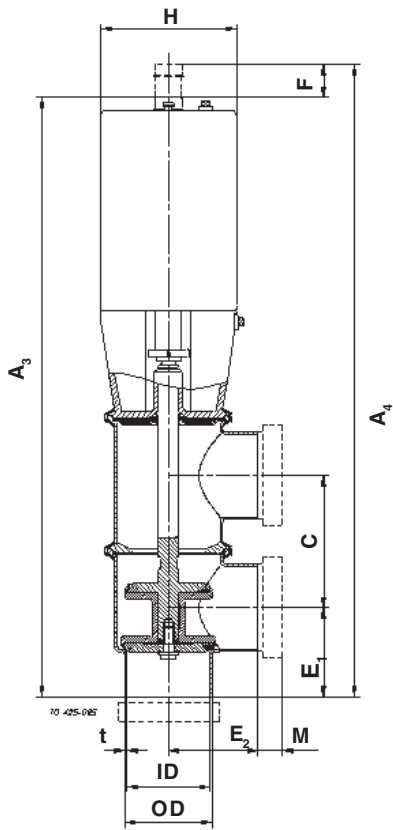

a. Divert valve

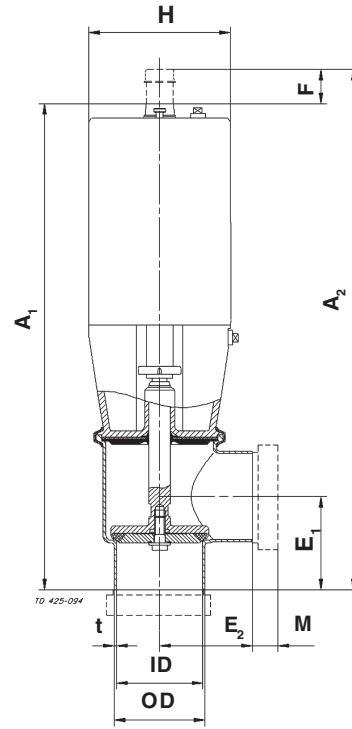

b. Shut-off valve

Figure 2. Dimensions

Size	1-inch	1.5-inch	2-inch	2.5-inch	3-inch	4-inch
A1	12.24	13.58	13.98	15.31	17.91	20.75
A2	13.07	14.56	14.96	16.30	19.17	22.01
A3	14.37	16.37	17.68	19.69	22.99	26.65
A4	15.26	17.36	18.66	20.67	24.25	27.91
C	2.19	3.11	3.70	4.45	5.08	6.42
OD	1.00	1.50	2.00	2.50	3.00	4.00
ID	0.87	1.37	1.87	2.37	2.83	3.84
t	0.059	0.063	0.063	0.063	0.078	0.078
E1	1.19	1.81	2.44	3.23	3.43	5.28
E2	2.24	1.81	2.44	3.23	3.43	5.28
F	0.83	0.98	0.98	0.98	1.26	1.26
H	3.43	3.50	3.50	3.50	5.25	5.25
M/GC-clamp	0.85	0.85	0.50	0.50	0.50	0.63

Caution, opening/closing time:
Opening/closing time will be affected by the following:

- The air supply (air pressure).
- The length and dimensions of the air hoses.
- Number of valves connected to the same air hose.
- Use of single solenoid valve for serial connected air actuator functions.
- Product pressure.

Air Connections

Compressed air:

R 1/8" (BSP), internal thread.

Technical data

Max. product pressure (depending on valve specifications): 145 PSI
Min. product pressure: Full vacuum.
Temperature range: 14° F to 284° F (EPDM)
Air pressure: 73-100 PSI

Air Consumption

Valve Size	NO or NC	A/A
1-inch - 2.5 inch	0.84 x air pressure (PSI)	2.95 x air pressure (PSI)
3-inch - 4-inch	1.68 x air pressure (PSI)	5.47 x air pressure (PSI)

Materials

Product wetted steel parts: Acid-resistant steel AISI 316L.
Finish: Semi bright.
Other steel parts: Stainless steel AISI 304.
Plug stem: AISI 316L with hard chrome plated stem surface.
Product wetted seals: EPDM rubber.
Other seals: Nitrile (NBR).

Options

Equipment

- A) Male parts or clamp liners in accordance with required standard.
- B) Control and Indication (see chapter in Product Catalog).
- C) Damper against water hammer.
- D) Actuator with reinforced spring.
- E) Larger actuator for valve sizes 1.5-inch and 2.5-inch.
- F) Stainless steel seal disc replacing standard lip seal.
- G) Two-step or three-position actuator.
- H) Tangential side port valve.

Ordering

Please state the following when ordering:

- Size.
- Connections if not welding ends
- Valve body combination
- Actuator function, NC, NO or A/A
- Options.

Material grades

- I) Industrial finish
- J) Elastomers of Nitrile (NBR), Fluorinated rubber (FPM) or PTFE

Tools

- K) Service tools for actuator.
 - Lifting tool
 - Turning tool

PD 60019 US8 2001-10

The information contained herein is correct at the time of issue, but may be subject to change without prior notice.

How to contact Alfa Laval
Contact details for all countries
are continually updated on our website.
Please visit www.alfalaval.com to
access the information direct.



CSI 417.831.1411
csidesigns.com