

# EXPLODED VIEW & PARTS LIST

## ALUMINUM AND STAINLESS STEEL PUMPS WITH ALUMINUM CENTER SECTION (S050-\*A\*-\*-\*-\*\*\*)

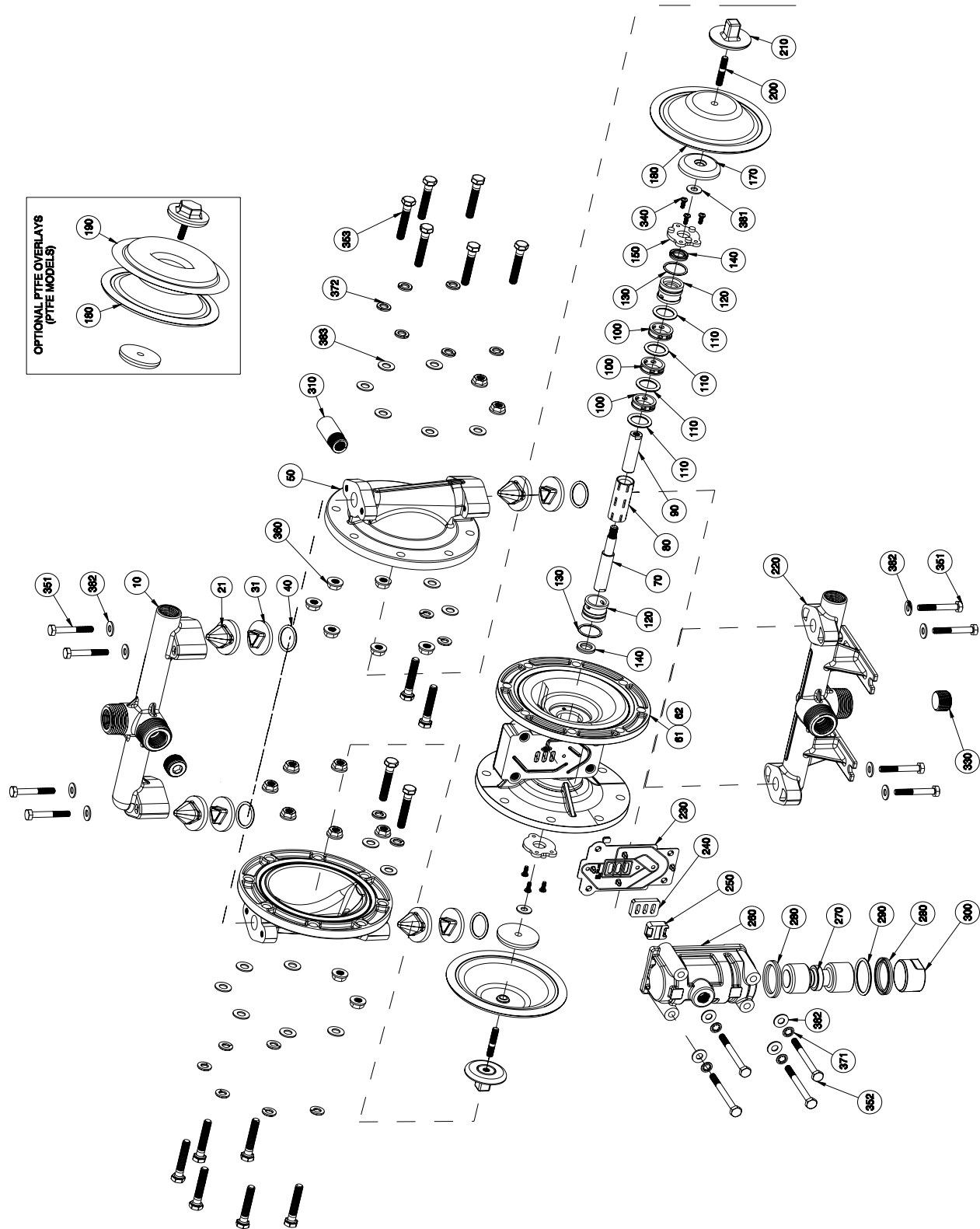

# PARTS LIST - ALUMINUM AND STAINLESS STEEL PUMPS WITH ALUMINUM CENTER SECTION (S050-\*A\*-\*-\*-\*\*\*)

ITEM	DESCRIPTION	QTY	PUMP MODEL	PART NO.	MATERIAL
10	DISCHARGE MANIFOLD	1	S050-N*A-*-*-0**	11329-20-MP-NPT	Aluminum
			S050-B*A-*-*-0**	11329-20-MP-BSPT	Aluminum
			S050-N*3-*-*-0**	11329-26-MP-NPT	Stainless Steel
			S050-B*3-*-*-0**	11329-26-MP-BSPT	Stainless Steel
21	MAX-PASS™ VALVE	4	S050-*-*N**-*	10915-11	Nitrile
			S050-*-*V**-*	10915-13	Viton®/FKM
			S050-*-*E**-*	10915-15	EPDM
31	MAX-PASS™ BACKUP	4	S050-*-*A**-*	10923-20	Aluminum
			S050-*-*3**-*	10923-26	Stainless Steel
40	O-RING (VALVE SEAT)	4	S050-*-*N**-*	11904-11	Nitrile
			S050-*-*V**-*	11904-13	Viton®/FKM
			S050-*-*E**-*	11904-15	EPDM
			S050-*-*T**-*	11904-17	PTFE
50	OUTER CHAMBER	2	S050-*A**-*	10720-20-MP	Aluminum
			S050-*3**-*	10720-26-MP	Stainless Steel
61 & 62	INTERMEDIATE	1	S050-*A**-*	11527-20	Aluminum
70 & 90	DIAPHRAGM ROD ASSEMBLY	1	ALL MODELS	33000-00	Stainless Steel
80	PILOT SLEEVE	1	ALL MODELS	10105-31 Δ	Acetel
100	INNER SPACER (PILOT SLEEVE)	3	ALL MODELS	10203-40 Δ	Polypropylene
110	O-RING (PILOT SLEEVE)	4	ALL MODELS	11920-16 Δ	Urethane
120	END SPACER (PILOT SLEEVE)	2	ALL MODELS	10204-40 Δ	Polypropylene
130	O-RING (END SPACER)	2	ALL MODELS	11923-11 Δ	Nitrile
140	LIP SEAL (DIAPHRAGM ROD)	2	ALL MODELS	12000-76 Δ	Nitrile
150	RETAINING PLATE	2	ALL MODELS	12708-54	Nylon
160	N/A				
170	INNER DIAPHRAGM PLATE	2	ALL MODELS	11100-40	Polypropylene
180	DIAPHRAGM	2	S050-*V**-*	10600-13	Viton®/FKM
			S050-*G**-*	10600-19	Geolast®
			S050-*N**-*	10600-21	Nitrile
			S050-*S**-*	10600-23	Santoprene®
			S050-*T**-*	10600-23	Santoprene®
190	OVERLAY (OPTIONAL)	2	S050-*T**-*	11400-59	PTFE
200 & 210	OUTER DIAPHRAGM PLATE	2	S050-*A**-*	11208-20	Aluminum
			S050-*3**-*	11208-26	Stainless Steel
220	SUCTION MANIFOLD	1	S050-N*A-*-*-0**	11328-20-NPT	Aluminum
			S050-B*A-*-*-0**	11328-20-BSPT	Aluminum
			S050-N*3-*-*-0**	11328-26-NPT	Stainless Steel
			S050-B*3-*-*-0**	11328-26-BSPT	Stainless Steel
230	AIR VALVE GASKET	1	ALL MODELS	12126-19 ‡	Nitrile
240	SHUTTLE PLATE	1	ALL MODELS	10416-77 ‡	Ceramic
250	SHUTTLE	1	ALL MODELS	10415-00 ‡	Special
260	AIR VALVE BODY	1	S050-*A**-*	42001-20 ‡	Aluminum
270	AIR VALVE SPOOL	1	ALL MODELS	10480-31 ‡	Acetel
280	LIP SEAL (AIR VALVE)	2	ALL MODELS	12003-76 ‡	Nitrile
290	O-RING (AIR VALVE END PLUG)	1	ALL MODELS	11913-11 ‡	Nitrile
300	AIR VALVE END PLUG	1	S050-*A**-*	11706-20 ‡	Aluminum
310	MUFFLER	1	ALL MODELS	13008-00	Standard
	MUFFLER (METAL)		Optional	13002-00	Metal
320	N/A				

# PARTS LIST - ALUMINUM AND STAINLESS STEEL PUMPS WITH ALUMINUM CENTER SECTION (S050-\*A\*-\*-\*-\*\*\*)

ITEM	DESCRIPTION	QTY	PUMP MODEL	PART NO.	MATERIAL
330	PIPE PLUG	2	S050-N*A-*-*-***)	12255-20-NPT	Aluminum
			S050-B*A-*-*-***)	12255-20-BSPT	Aluminum
			S050-N*3-*-*-***)	12255-26-NPT	Stainless Steel
			S050-B*3-*-*-***)	12255-26-BSPT	Stainless Steel
340	PAN-HEAD MACH SCREW (#6-32 x 7/16)	6	S050-*A*-*-*-***)	12585-26	Stainless Steel
351	HEX HEAD CAP SCREW (1/4"-20 x 1-3/4")	8	S050-*A*-*-*-***)	12500-25	Plated Steel
			S050-*3*-*-*-***)	12500-26	Stainless Steel
352	HEX HEAD CAP SCREW (1/4"-20 x 2-3/4")	4	S050-*AA*-*-*-***)	12576-25	Plated Steel
			S050-*A3*-*-*-***)	12576-26	Stainless Steel
353	HEX HEAD CAP SCREW (5/16-18 x 1-3/4")	16	S050-*A*-*-*-***)	12503-25	Plated Steel
			S050-*3*-*-*-***)	12503-26	Stainless Steel
360	HEX FLANGE NUT (5/16"-18)	16	S050-*A*-*-*-***)	12608-25	Plated Steel
			S050-*3*-*-*-***)	12608-26	Stainless Steel
371	LOCK WASHER (1/4")	4	S050-*A*-*-*-***)	12350-25	Plated Steel
			S050-*3*-*-*-***)	12350-26	Stainless Steel
372	WASHER, SPLIT LOCK (5/16")	16	S050-*A*-*-*-***)	12313-25	Plated Steel
			S050-*3*-*-*-***)	12313-26	Stainless Steel
381	WASHER (1/4")	2	ALL MODELS	12300-26	Stainless Steel
382	WASHER (1/4")	12	S050-*A*-*-*-***)	12300-25	Plated Steel
		12	S050-*3*-*-*-***)	12300-26	Stainless Steel
383	WASHER (5/16")	16	S050-*A*-*-*-***)	12310-25	Plated Steel
			S050-*3*-*-*-***)	12310-26	Stainless Steel
390	N/A				
400	GROUNDING LUG (NOT SHOWN)	1	OPTIONAL	13481-20	Aluminum
	Magnalube® .75 oz. (As Required)		ALL MODELS	13404-00	Grease

\* Any Character

‡, Δ Only sold as part of assembly

ASSEMBLY PART NUMBERS	PUMP MODEL	PART NO.	MATERIAL
‡ AIR VALVE ASSEMBLY 230, 240, 250, 260, 270, 280, 290, 300	S050-*A*-*-*-***)	SMK-050-A	Various
Δ PILOT SIEVE ASSEMBLY 80, 100, 110, 120, 130, 140	S050-*A*-*-*-***)	SPK-050-A	Various

# EXPLODED VIEW & PARTS LIST

## ALUMINUM AND STAINLESS STEEL PUMPS WITH PLASTIC CENTER SECTION (S050-\*P\*-\*\*\*\*\*-\*\*\*)

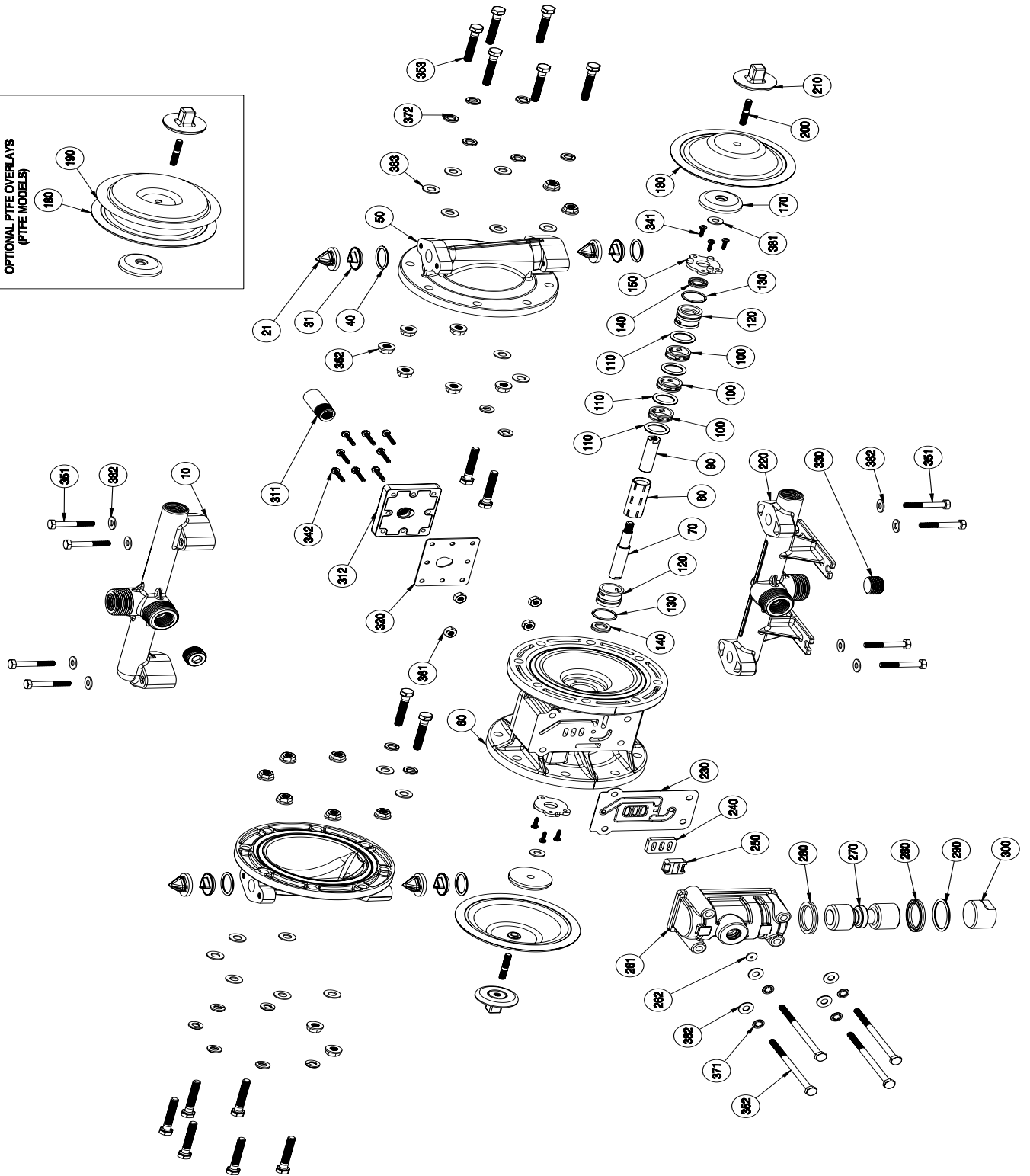
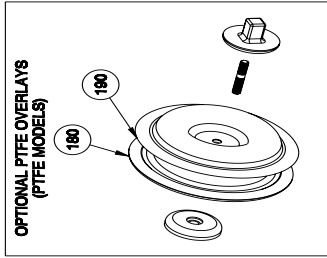

# PARTS LIST - ALUMINUM AND STAINLESS STEEL PUMPS WITH PLASTIC CENTER SECTION (S050-\*P\*-\*\*\*-\*\*\*)

ITEM	DESCRIPTION	QTY	PUMP MODEL	PART NO.	MATERIAL
10	DISCHARGE MANIFOLD	1	S050-N*A-****-0**	11329-20-MP-NPT	Aluminum
			S050-B*A-****-0**	11329-20-MP-BSPT	Aluminum
			S050-N*3-****-0**	11329-26-MP-NPT	Stainless Steel
			S050-B*3-****-0**	11329-26-MP-BSPT	Stainless Steel
21	MAX-PASS™ VALVE	4	S050-***N***	10915-11	Nitrile
			S050-***V***	10915-13	Viton®/FKM
			S050-***E***	10915-15	EPDM
31	MAX-PASS™ BACKUP	4	S050-***A***	10923-20	Aluminum
			S050-***3***	10923-26	Stainless Steel
40	O-RING (VALVE SEAT)	4	S050-***N***	11904-11	Nitrile
			S050-***V***	11904-13	Viton®/FKM
			S050-***E***	11904-15	EPDM
			S050-***T***	11904-17	PTFE
50	OUTER CHAMBER	2	S050-**A****	10720-20-MP	Aluminum
			S050-**3****	10720-26-MP	Stainless Steel
60	INTERMEDIATE	1	S050-*P*-****-***	11521-60	Polypropylene
70 & 90	DIAPHRAGM ROD ASSEMBLY	1	ALL MODELS	33000-00	Stainless Steel
80	PILOT SLEEVE	1	ALL MODELS	10105-31 Δ	Acetel
100	INNER SPACER (PILOT SLEEVE)	3	ALL MODELS	10203-40 Δ	Polypropylene
110	O-RING (PILOT SLEEVE)	4	ALL MODELS	11920-16 Δ	Urethane
120	END SPACER (PILOT SLEEVE)	2	ALL MODELS	10204-40 Δ	Polypropylene
130	O-RING (END SPACER)	2	ALL MODELS	11923-11 Δ	Nitrile
140	LIP SEAL (DIAPHRAGM ROD)	2	ALL MODELS	12000-76 Δ	Nitrile
150	RETAINING PLATE	2	ALL MODELS	12708-54	Nylon
160	N/A				
170	INNER DIAPHRAGM PLATE	2	ALL MODELS	11100-40	Polypropylene
180	DIAPHRAGM	2	S050-***V***	10600-13	Viton®/FKM
			S050-***G***	10600-19	Geolast®
			S050-***N***	10600-21	Nitrile
			S050-***S***	10600-23	Santoprene®
			S050-***T***	10600-23	Santoprene®
190	OVERLAY (OPTIONAL)	2	S050-***T***	11400-59	PTFE
200 & 210	OUTER DIAPHRAGM PLATE	2	S050-**A****	11208-20	Aluminum
			S050-**3****	11208-26	Stainless Steel
220	SUCTION MANIFOLD	1	S050-N*A-****-0**	11328-20-NPT	Aluminum
			S050-B*A-****-0**	11328-20-BSPT	Aluminum
			S050-N*3-****-0**	11328-26-NPT	Stainless Steel
			S050-B*3-****-0**	11328-26-BSPT	Stainless Steel
230	AIR VALVE GASKET	1	ALL MODELS	12116-19 ‡	Nitrile
240	SHUTTLE PLATE	1	ALL MODELS	10416-77 ‡	Ceramic
250	SHUTTLE	1	ALL MODELS	10415-00 ‡	Special
261	AIR VALVE BODY	1	S050-*P*-****-***	11614-60 ‡	Polypropylene
270	AIR VALVE SPOOL	1	ALL MODELS	10480-31 ‡	Acetel
280	LIP SEAL (AIR VALVE)	2	ALL MODELS	12003-76 ‡	Nitrile
290	O-RING (AIR VALVE END PLUG)	1	ALL MODELS	11913-11 ‡	Nitrile
300	AIR VALVE END PLUG	1	S050-*P*-****-***	11703-60 ‡	Polypropylene
311	MUFFLER	1	ALL MODELS	13008-00	Standard
	MUFFLER (METAL)		Optional	13002-00	Metal
312	MUFFLER PLATE	1	S050-*P*-****-***	13111-60	Polypropylene

# PARTS LIST - ALUMINUM AND STAINLESS STEEL PUMPS WITH PLASTIC CENTER SECTION (S050-\*P\*-\*\*\*\*-\*\*\*)

ITEM	DESCRIPTION	QTY	PUMP MODEL	PART NO.	MATERIAL
320	MUFFLER PLATE GASKET	1	S050-*P*-****-***	12117-19	Nitrile
330	PIPE PLUG	2	S050-N*A-****-***	12255-20-NPT	Aluminum
			S050-B*A-****-***	12255-20-BSPT	Aluminum
			S050-N*3-****-***	12255-26-NPT	Stainless Steel
			S050-B*3-****-***	12255-26-BSPT	Stainless Steel
341	SCREW, SELF-TAP (#6 X 1/2")	6	S050-*P*-****-***	12510-26	Stainless Steel
342	SCREW, SLOTTED HEAD SELF-TAP (1")	8	S050-*P*-****-***	12525-26	Stainless Steel
351	HEX HEAD CAP SCREW (1/4"-20 x 1-3/4")	8	S050-**A-****-***	12500-25	Plated Steel
			S050-**3-****-***	12500-26	Stainless Steel
352	HEX HEAD CAP SCREW (1/4"-20 x 4-1/2")	4	S050-*PA-****-***	12513-25	Plated Steel
			S050-*P3-****-***	12513-26	Stainless Steel
353	HEX HEAD CAP SCREW (5/16-18 x 1-3/4")	16	S050-**A-****-***	12503-25	Plated Steel
			S050-**3-****-***	12503-26	Stainless Steel
361	HEX NUT (1/4"-20)	4	S050-*PA-****-***	12600-25	Plated Steel
			S050-*P3-****-***	12600-26	Stainless Steel
362	HEX FLANGE NUT (5/16"-18)	16	S050-*PA-****-***	12608-25	Plated Steel
			S050-*P3-****-***	12608-26	Stainless Steel
371	LOCK WASHER (1/4")	4	S050-**A-****-***	12350-25	Plated Steel
			S050-**3-****-***	12350-26	Stainless Steel
372	WASHER, SPLIT LOCK (5/16")	16	S050-**A-****-***	12313-25	Plated Steel
			S050-**3-****-***	12313-26	Stainless Steel
381	WASHER (1/4")	2	ALL MODELS	12300-26	Stainless Steel
382	WASHER (1/4")	12	S050-**A-****-***	12300-25	Plated Steel
			S050-**3-****-***	12300-26	Stainless Steel
383	WASHER (5/16")	16	S050-**A-****-***	12310-25	Plated Steel
			S050-**3-****-***	12310-26	Stainless Steel
390	N/A				
400	GROUNDING LUG (NOT SHOWN)	1	OPTIONAL	13481-20	Aluminum
	Magnalube® .75 oz. (As Required)		ALL MODELS	13404-00	Grease

\* Any Character

‡, Δ Only sold as part of assembly

ASSEMBLY PART NUMBERS	PUMP MODEL	PART NO.	MATERIAL
‡ AIR VALVE ASSEMBLY 230, 240, 250, 261, 270, 280, 290, 300	S050-*P*-****-***	SMK-050-P	Various
Δ PILOT SEEVE ASSEMBLY 80, 100, 110, 120, 130, 140	S050-*P*-****-***	SPK-050-P	Various

# EXPLODED VIEW & PARTS LIST

## ALUMINUM & STAINLESS STEEL

### S100-\*A\*-\*-\*-\*-\*

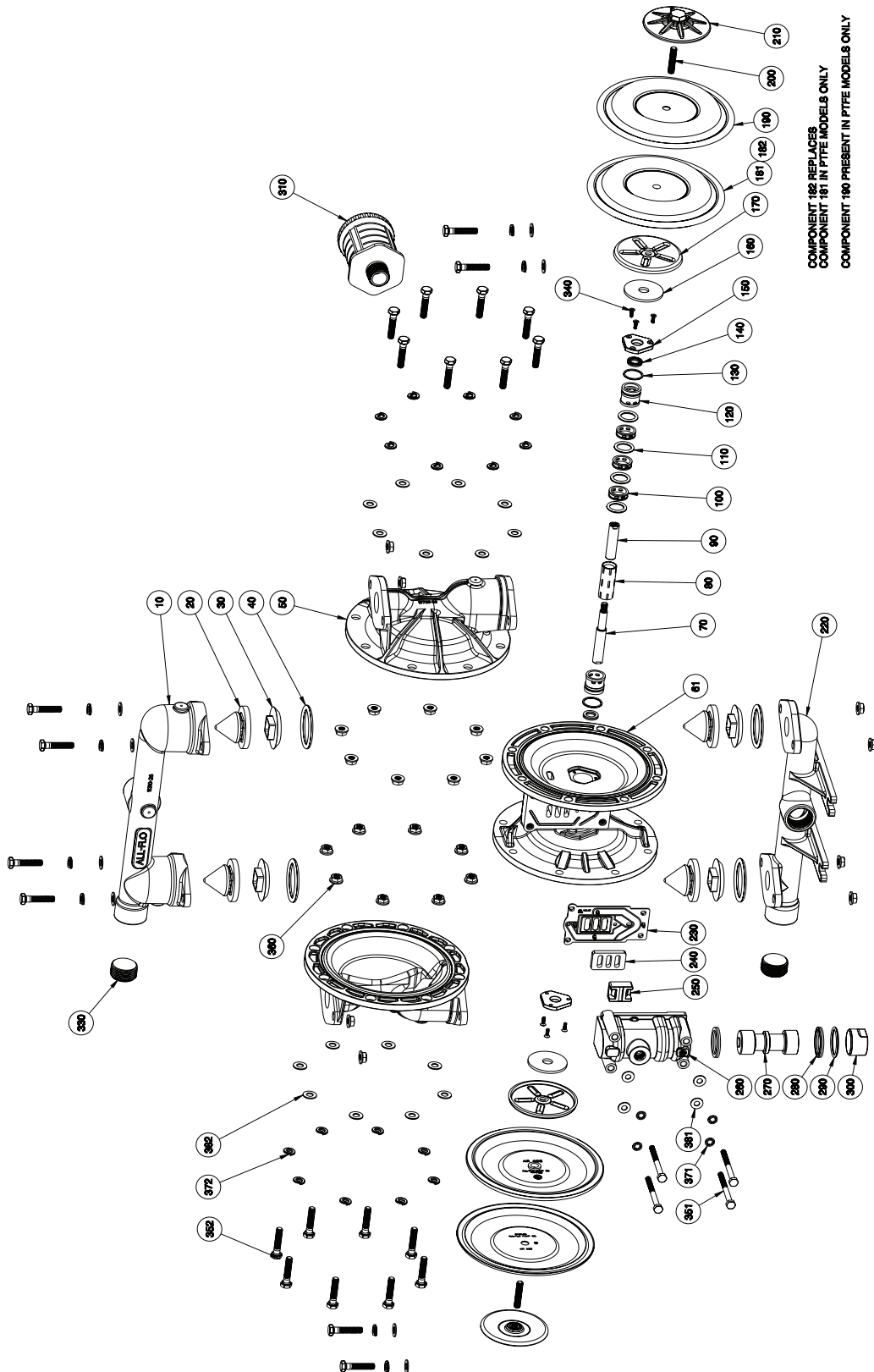

COMPONENT 182 REPLACES  
COMPONENT 181 IN PTFE MODELS ONLY  
COMPONENT 180 PRESENT IN PTFE MODELS ONLY



# PARTS LIST - ALUMINUM & STAINLESS STEEL

S100-\*A\*-\*\*\*\*-\*\*\*

ITEM	DESCRIPTION	QTY	PUMP MODEL	PART NO.	MATERIAL
10	DISCHARGE MANIFOLD	1	S100-NAA-****-0**	11310-20-NPT-MP	Aluminum
			S100-BAA-****-0**	11310-20-BSPT-MP	Aluminum
			S100-NA3-****-0**	11310-26-NPT-MP	Stainless Steel
			S100-BA3-****-0**	11310-26-BSPT-MP	Stainless Steel
20	MAX-PASS™ VALVE	4	S100-BA3-*N**-*	10911-11	Nitrile
			S100-BA3-*E**-*	10911-15	EPDM
			S100-BA3-*V**-*	10911-82	Viton
30	MAX-PASS™ BACKUP	4	S100-BA3-**A*-***	10912-20	Aluminum
			S100-BA3-**3*-***	10912-26	Stainless Steel
40	O-RING (VALVE SEAT)	4	S100-*A*-***N-***	11947-11	Nitrile
			S100-*A*-***V-***	11947-13	Viton®/FKM
			S100-*A*-***E-***	11947-15	EPDM
			S100-*A*-***T-***	11947-17	PTFE
50	OUTER CHAMBER	2	S100-*AA-****-***	10726-20-MP	Aluminum
			S100-*A3-****-***	10726-26-MP	Stainless Steel
61	INTERMEDIATE	1	ALL MODELS	11526-20	Aluminum
70 & 90	DIAPHRAGM ROD ASSEMBLY	1	ALL MODELS	35005-00	Stainless Steel
80	PILOT SLEEVE	1	ALL MODELS	10105-31 Δ	Acetel
100	INNER SPACER (PILOT SLEEVE)	3	ALL MODELS	10203-40 Δ	Polypropylene
110	O-RING (PILOT SLEEVE)	4	ALL MODELS	11920-16 Δ	Urethane
120	END SPACER (PILOT SLEEVE)	2	ALL MODELS	10209-40 Δ	Polypropylene
130	O-RING (END SPACER)	2	ALL MODELS	11923-16 Δ	Urethane
140	LIP SEAL (DIAPHRAGM ROD)	2	ALL MODELS	12000-76 Δ	Nitrile
150	RETAINING PLATE	2	ALL MODELS	12718-54	Nylon
160	BUMPER	2	ALL MODELS	12325-16	Urethane
170	INNER DIAPHRAGM PLATE	2	ALL MODELS	11104-25	Plated Steel
181	DIAPHRAGM	2	S100-*A*-N***-***	10612-11	Buna-N
			S100-*A*-V***-***	10612-13	Viton®/FKM
			S100-*A*-E***-***	10612-15	EPDM
			S100-*A*-G***-***	10612-19	Geolast®
			S100-*A*-S***-***	10612-23	Santoprene®
182	DIAPHRAGM, BACKUP (PTFE ONLY)	2	A100-*A*-T***-***	10613-23	Santoprene®
190	PTFE OVERLAY (PTFE ONLY)	2	A100-*A*-T***-***	11409-59	PTFE
200&210	OUTER DIAPHRAGM PLATE W/ STUD	2	S100-*AA-****-***	11220-20	Aluminum
			S100-*A3-****-***	11220-26	Stainless Steel
220	SUCTION MANIFOLD	1	S100-NAA-****-0**	11311-20-NPT	Aluminum
			S100-BAA-****-0**	11311-20-BSPT	Aluminum
			S100-NA3-****-0**	11311-26-NPT	Stainless Steel
			S100-BA3-****-0**	11311-26-BSPT	Stainless Steel
230	AIR VALVE GASKET	1	ALL MODELS	12125-19 ‡	Nitrile
240	SHUTTLE PLATE	1	ALL MODELS	10451-77 ‡	Ceramic
250	SHUTTLE	1	ALL MODELS	10431-32 ‡	Special
260	AIR VALVE BODY	1	ALL MODELS	11619-20 ‡	Aluminum
270	AIR VALVE SPOOL	1	ALL MODELS	10482-31 ‡	Acetel
280	LIP SEAL (AIR VALVE)	2	ALL MODELS	12003-76 ‡	Nitrile
290	O-RING (AIR VALVE END PLUG)	1	ALL MODELS	11913-11 ‡	Nitrile





# PARTS LIST - ALUMINUM & STAINLESS STEEL

## S100-\*A\*-\*\*\*\*-\*\*\*

ITEM	DESCRIPTION	QTY	PUMP MODEL	PART NO.	MATERIAL
300	AIR VALVE END PLUG	1	ALL MODELS	11706-20 ‡	Aluminum
310	MUFFLER MUFFLER (METAL)	1	ALL MODELS OPTIONAL	13001-00 13009-00	Standard Metal
320	N/A				
330	PIPE PLUG	2	S100-NAA-****-0** S100-BAA-****-0** S100-NA3-****-0** S100-BA3-****-0**	12265-20-NPT 12265-20-BSPT 12265-26-NPT 12265-26-BSPT	Aluminum Aluminum Stainless Steel Stainless Steel
340	SCREW, FLAT HEAD (#6-32 X 7/16")	6	ALL MODELS	12578-26	Stainless Steel
351	SCREW, HEX HEAD CAP (1/4"-20 X 3")	4	S100-*AA-****-*** S100-*A3-****-***	12516-25 12516-26	Plated Steel Stainless Steel
352	SCREW, HEX HEAD CAP (5/16"-18 X 1-1/2")	24	S100-*AA-****-*** S100-*A3-****-***	12584-25 12584-26	Plated Steel Stainless Steel
360	NUT, HEX FLANGE (5/16"-18)	24	S100-*AA-****-*** S100-*A3-****-***	12608-25 12608-26	Plated Steel Stainless Steel
371	WASHER, LOCK (1/4")	4	S100-*AA-****-*** S100-*A3-****-***	12350-25 12350-26	Plated Steel Stainless Steel
372	WASHER, SPLIT LOCK (5/16")	24	S100-*AA-****-*** S100-*A3-****-***	12313-25 12313-26	Plated Steel Stainless Steel
381	WASHER (1/4")	4	S100-*AA-****-*** S100-*A3-****-***	12300-25 12300-26	Plated Steel Stainless Steel
382	WASHER (5/16")	24	S100-*AA-****-*** S100-*A3-****-***	12310-25 12310-26	Plated Steel Stainless Steel
400	GROUNDING LUG (NOT SHOWN)	1	OPTIONAL	13481-20	Aluminum
	Magnalube® .75 oz. (As Required)		ALL MODELS	13404-00	Grease

\* Any Character

‡, Δ Only sold as part of assembly

ASSEMBLY PART NUMBERS	PUMP MODEL	PART NO.	MATERIAL
‡ AIR VALVE ASSEMBLY 230, 240, 250, 260, 270, 280, 290, 300	ALL MODELS	SMK-100-A	Various
Δ PILOT SEEVE ASSEMBLY 80, 100, 110, 120, 130, 140	ALL MODELS	SPK-100-A	Various

# EXPLODED VIEW & PARTS LIST

S050-SP\*-\*\*\*\*-\*\*\* PLASTIC SOLIDS

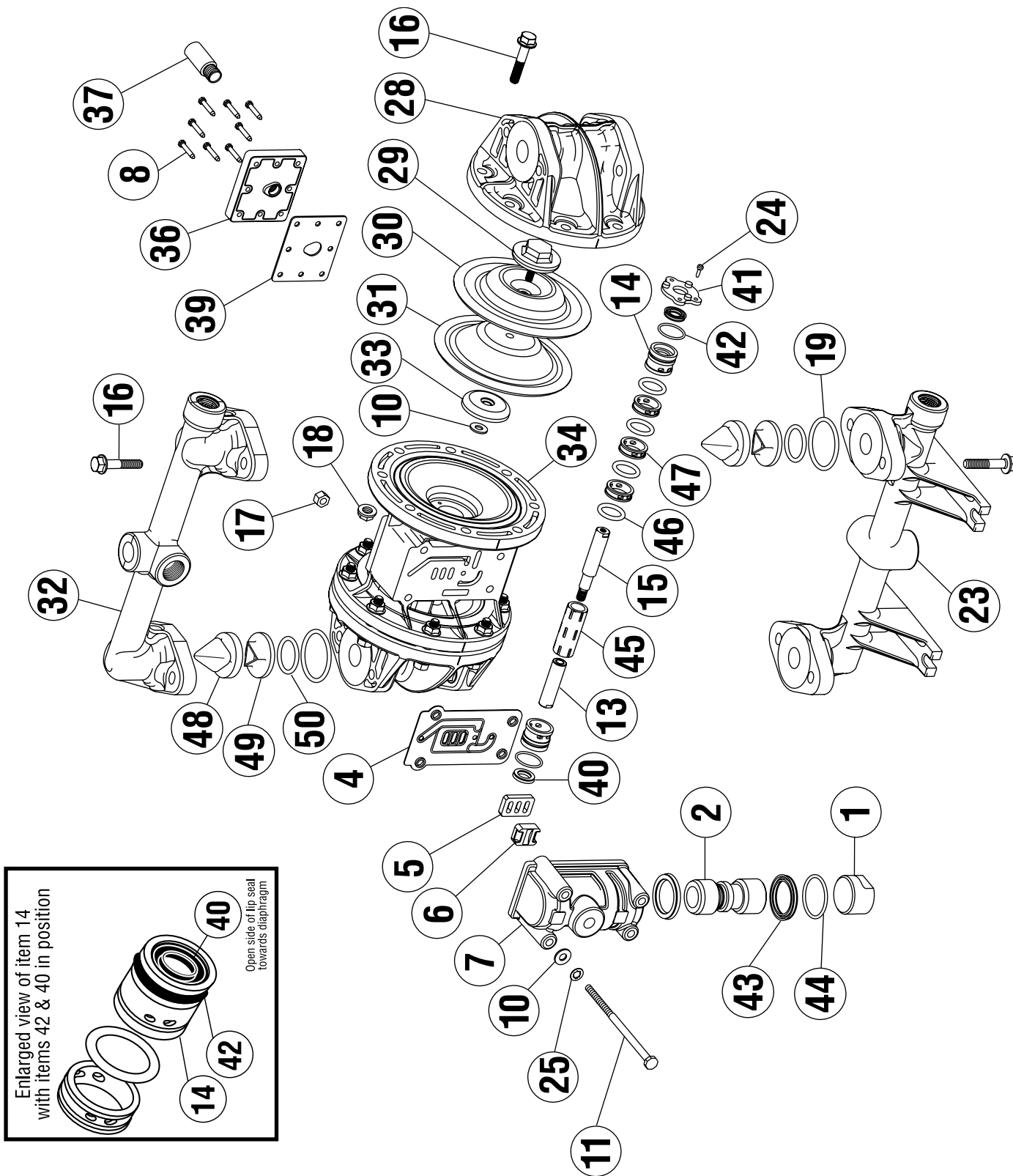

# PARTS LIST - PLASTIC SOLIDS

## S050-SP\*-\*\*\*-\*\*\*

ITEM	DESCRIPTION	QTY	PUMP MODEL	PART NO.	MATERIAL
1	AIR VALVE END PLUG	1	ALL MODELS	11703-60	Polypropylene
2	AIR VALVE SPOOL	1	ALL MODELS	10480-31	Acetal
4	AIR VALVE GASKET	1	ALL MODELS	12116-19	Nitrile
5	SHUTTLE PLATE	1	ALL MODELS	10416-77	Ceramic
6	SHUTTLE	1	ALL MODELS	10415-00	Special
7	AIR VALVE BODY	1	ALL MODELS	11614-60	Polypropylene
8	SLT WSHD SCREW (#8 X 1")	8	ALL MODELS (NON-PTFE COATED)	12525-26	Stainless Steel
10	FLAT WASHER (1/4")	6	ALL MODELS (NON-PTFE COATED)	12300-26	Stainless Steel
11	CAP SCREW (1/4" X 4-1/2")	4	ALL MODELS (NON-PTFE COATED)	12513-26	Stainless Steel
13	DIAPHRAGM ROD (Short)	1	ALL MODELS	*SEE NOTE	Stainless Steel
14	END SPACER (Pilot Sleeve)	2	ALL MODELS	10204-40	Polypropylene
15	DIAPHRAGM ROD (Long)	1	ALL MODELS	*SEE NOTE	Stainless Steel
16	FLNG BOLT (5/16" X 1-5/8")	24	ALL MODELS (NON-PTFE COATED)	12539-26	Stainless Steel
17	HEX NUT (1/4" - 20)	4	ALL MODELS (NON-PTFE COATED)	12600-26	Stainless Steel
18	FLNG HEX NUT (5/16" - 18)	24	ALL MODELS (NON-PTFE COATED)	12608-26	Stainless Steel
19	O-RING (Manifolds)	4	S050-SP*-***N-*** S050-SP*-***V-*** S050-SP*-***E-*** S050-SP*-***T-***	11936-11 11936-13 11936-15 11936-17	Nitrile Viton®/FKM EPDM PTFE
23	SUCTION MANIFOLD	1	S050-SPP-****-*** S050-SPY-****-*** S050-SPK-****-***	10553-40 10553-46 10553-56	Polypropylene Conductive Nylon PVDF
24	SELF TAP SCREW (#6 X 1/2")	6	ALL MODELS	12510-26	Stainless Steel
25	LOCK WASHER (1/4")	4	ALL MODELS (NON-PTFE COATED)	12350-26	Stainless Steel
28	OUTER CHAMBER	2	S050-SPP-****-*** S050-SPY-****-*** S050-SPK-****-***	10722-40 10722-46 10722-56	Polypropylene Conductive Nylon PVDF
29	OUTER DIAPHRAGM PLATE	2	S050-SPP-****-*** S050-SPY-****-*** S050-SPK-****-***	11200-40 11200-46 11200-56	Polypropylene Conductive Nylon PVDF
30	OVERLAY (PTFE ONLY)	2	S050-SP*-T***-***	11400-59	PTFE
31	DIAPHRAGM	2	S050-SP*-V***-*** S050-SP*-G***-*** S050-SP*-S***-*** S050-SP*-T***-***	10600-13 10600-19 10600-23 10600-23	Viton®/FKM Geolast® Santoprene® Santoprene®
32	DISCHARGE MANIFOLD	1	S050-SPP-****-*** S050-SPY-****-*** S050-SPK-****-***	10557-AF-40 10557-AF-46 10557-AF-56	Polypropylene Conductive Nylon PVDF
33	INNER DIAPHRAGM PLATE	2	S050-SPP-****-*** S050-SPY-****-*** S050-SPK-****-***	11100-40 11100-46 11100-56	Polypropylene Conductive Nylon PVDF



# EXPLODED VIEW & PARTS LIST

S038-SQ\*-\*\*\*\*-\*\*\* PLASTIC SOLIDS

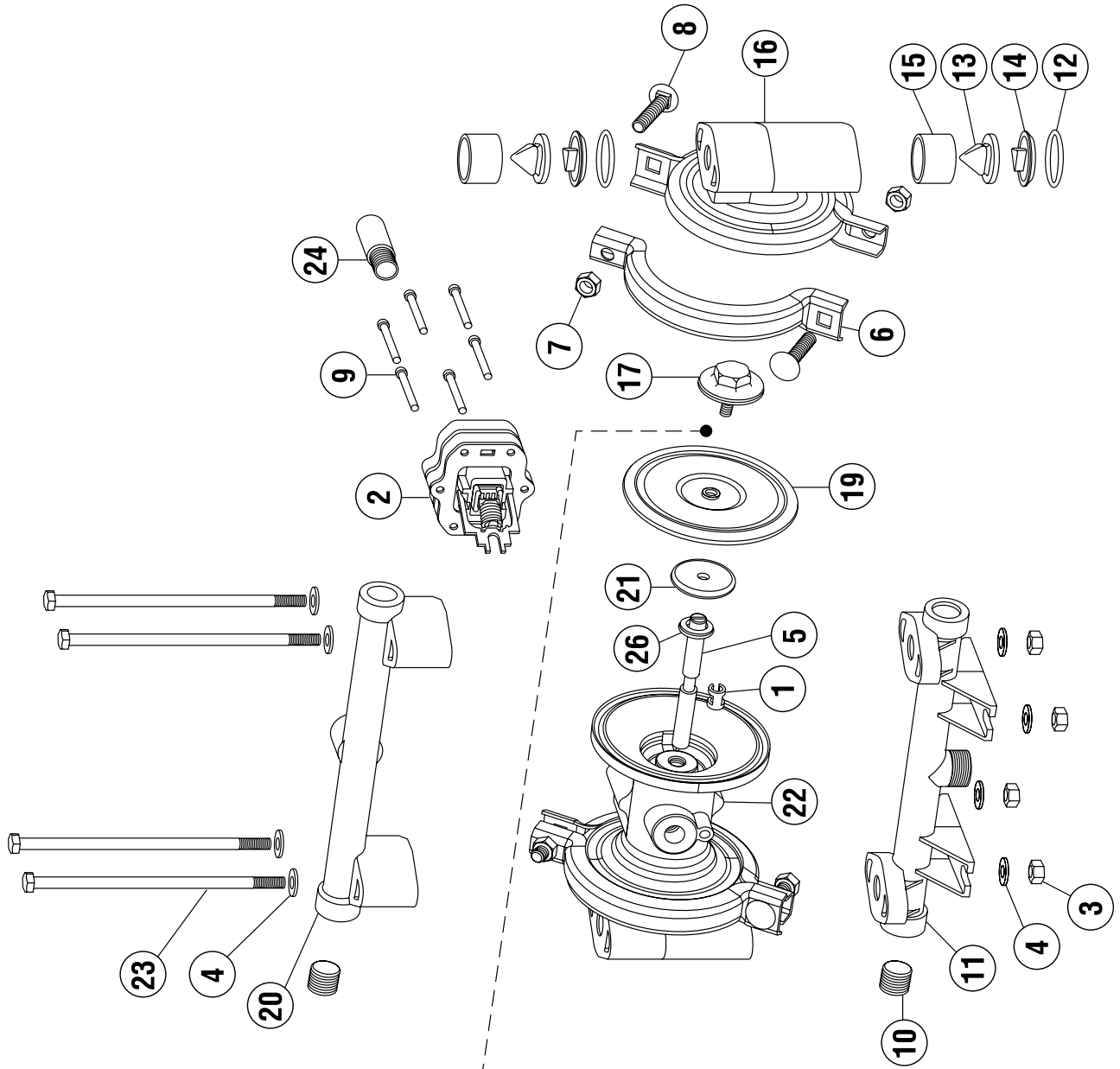

Diaphragm configuration for PTFE pumps.

PTFE Diaphragm requires O-ring.



# PARTS LIST - PLASTIC SOLIDS

## S038-SQ\*-\*\*\*\*-\*\*\*

ITEM	DESCRIPTION	QTY	PUMP MODEL	PART NO.	MATERIAL
1	ROD GUIDE	1	ALL MODELS	12807-31	Acetal
2	AIR VALVE ASSEMBLY	1	ALL MODELS	40380-54	Various
3	HEX NUT (1/4" - 20)	4	ALL MODELS (NON-PTFE COATED)	12600-26	Stainless Steel
4	FLAT WASHER	8	ALL MODELS (NON-PTFE COATED)	12300-26	Stainless Steel
5	DIAPHRAGM ROD	1	ALL MODELS	10316-26	Stainless Steel
6	CLAMP (Complete with fasteners)	2	ALL MODELS (NON-PTFE COATED)	12913-26	Stainless Steel
7	HEX HUT (5/16" - 18)	4	ALL MODELS (NON-PTFE COATED)	12601-26	Stainless Steel
8	CARRIAGE BOLT (5/16" x 1-1/2")	4	ALL MODELS (NON-PTFE COATED)	12509-26	Stainless Steel
9	SCREW (#8 x 1-3/4")	6	ALL MODELS (NON-PTFE COATED)	12548-26	Stainless Steel
10	PIPE PLUG, 3/8" NPT	2	S038-SPP-****-*** S038-SPY-****-*** S038-SPK-****-***	12206-40 12206-42 12206-56	Polypropylene Nylon PVDF
11	SUCTION MANIFOLD	1	S038-SPP-****-*** S038-SPY-****-*** S038-SPK-****-***	10570-40 10570-46 10570-56	Polypropylene Conductive Nylon PVDF
12	O-RING (Valve Seat)	4	S038-SP*-***N-*** S038-SP*-***E-*** S038-SP*-***T-*** S038-SP*-***V-***	11938-11 11938-15 11938-17 11938-82	Nitrile EPDM PTFE Viton®/FKM
13	MAX-PASS™ VALVE	4	S038-SP*-*N**-* S038-SP*-*V**-* S038-SP*-*E**-*	10915-11 10915-13 10915-15	Nitrile Viton®/FKM EPDM
14	MAX-PASS™ BACKUP	4	S038-SPP-****-*** S038-SPY-****-*** S038-SPK-****-***	10916-40 10916-46 10916-56	Polypropylene Conductive Nylon PVDF
15	MAX-PASS™ SLEEVE	4	S038-SPP-****-*** S038-SPY-****-*** S038-SPK-****-***	10917-40 10917-42 10917-56	Polypropylene Nylon PVDF
16	OUTER CHAMBER	2	S038-SPP-****-*** S038-SPY-****-*** S038-SPK-****-***	10701-40 10701-46 10701-56	Polypropylene Conductive Nylon PVDF
17	OUTER DIAPHRAGM PLATE	2	S038-SPP-****-*** S038-SPY-****-*** S038-SPK-****-***	11201-40 11201-46 11201-56	Polypropylene Conductive Nylon PVDF
18	DIAPHRAGM (PTFE ONLY)	2	S038-SP*-T***-***	11401-59	PTFE
19	DIAPHRAGM	2	S038-SP*-G***-*** S038-SP*-S***-***	10601-19 10601-23	Geolast® Santoprene®
20	DISCHARGE MANIFOLD	1	S038-SPP-****-*** S038-SPY-****-*** S038-SPK-****-***	10571-AF-40 10571-AF-46 10571-AF-56	Polypropylene Conductive Nylon PVDF
21	INNER DIAPHRAGM PLATE	2	ALL MODELS	11101-25	Plated Steel
22	INTERMEDIATE	1	ALL MODELS	11503-60	Polypropylene
23	CAP SCREW	4	ALL MODELS (NON-PTFE COATED)	12515-26	Stainless Steel
24	MUFFLER	1	ALL MODELS	13008-00	Polypropylene
25	O-RING (Diaphragm, PTFE ONLY)	2	S038-SP*-T***-***	11942-11	Nitrile
26	LIP SEAL	2	ALL MODELS	12005-76	Nitrile

\* Any Character

# EXPLODED VIEW & PARTS LIST

S100-*\*P\**-*\*\*\*\**-*\*\*\** PLASTIC SOLIDS

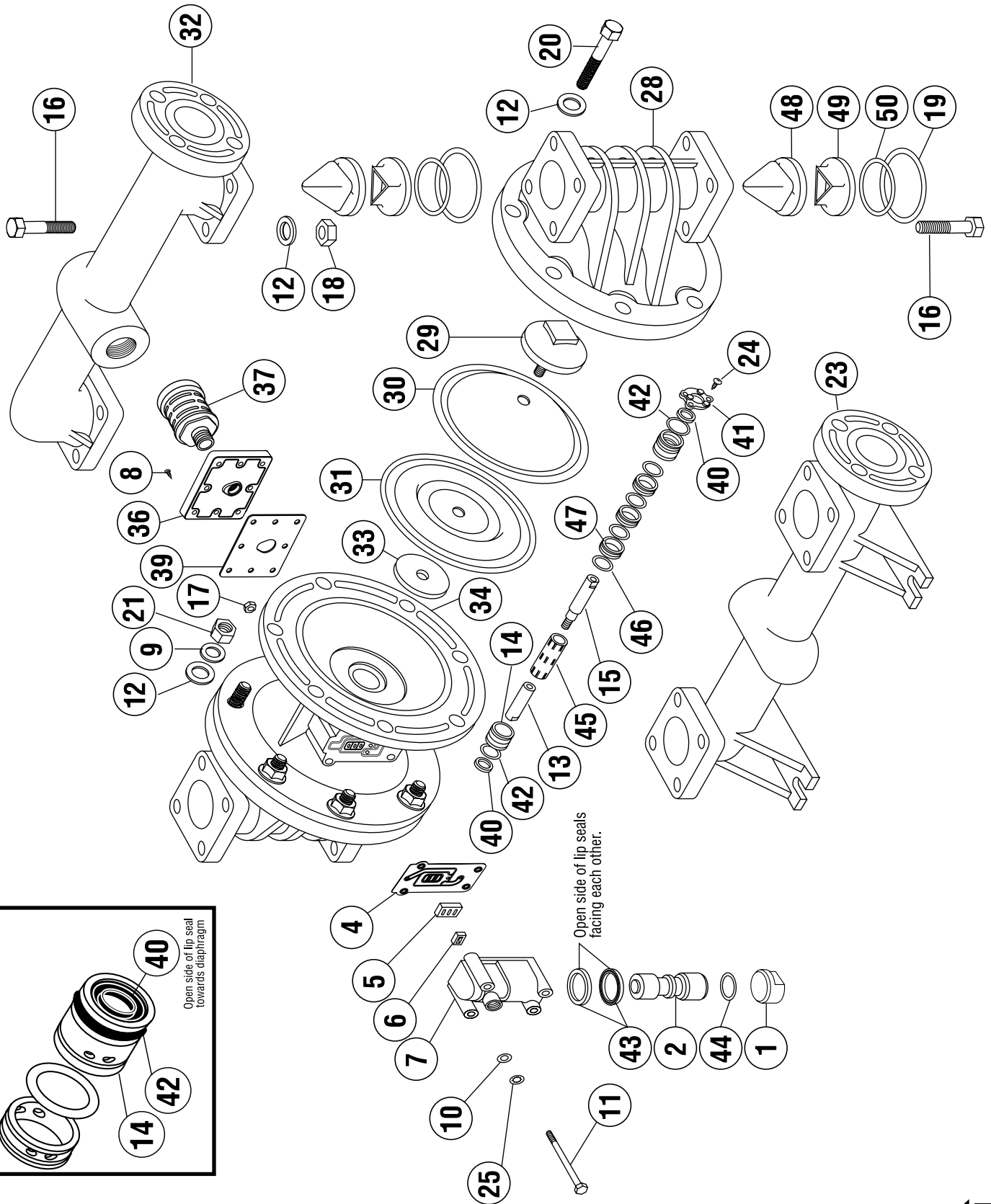

Enlarged view of item 14 with items 42 & 48 in position

Open side of lip seal towards diaphragm

Open side of lip seals facing each other.



# PARTS LIST - PLASTIC SOLIDS

## S100-\*P\*-\*\*\*\*-\*\*\*

ITEM	DESCRIPTION	QTY	PUMP MODEL	PART NO.	MATERIAL
1	AIR VALVE END PLUG	1	ALL MODELS	11703-60	Polypropylene
2	AIR VALVE SPOOL	1	ALL MODELS	10480-31	Acetal
4	AIR VALVE GASKET	1	ALL MODELS	12116-19	Nitrile
5	SHUTTLE PLATE	1	ALL MODELS	10416-77	Ceramic
6	SHUTTLE	1	ALL MODELS	10415-00	Special
7	AIR VALVE BODY	1	ALL MODELS	11614-60	Polypropylene
8	SLT WSHR (#8 X 1") SCREW	8	ALL MODELS (NON-PTFE COATED)	12525-26	Stainless Steel
9	SPLIT LOCKWASHER (3/8")	16	ALL MODELS (NON-PTFE COATED)	12316-26	Stainless Steel
10	FLAT WASHER (1/4")	4	ALL MODELS (NON-PTFE COATED)	12300-26	Stainless Steel
11	CAP SCREW (1/4" X 5")	4	ALL MODELS (NON-PTFE COATED)	12512-26	Stainless Steel
12	FLAT WASHER (3/8")	64	ALL MODELS (NON-PTFE COATED)	12303-26	Stainless Steel
13	DIAPHRAGM ROD (Short)	1	ALL MODELS	*	Stainless Steel
14	END SPACER (Pilot Sleeve)	2	ALL MODELS	10204-40	Polypropylene
15	DIAPHRAGM ROD (Long)	1	ALL MODELS	*	Stainless Steel
16	BOLT (5/16" X 2-1/4")	16	ALL MODELS (NON-PTFE COATED)	12547-26	Stainless Steel
17	HEX NUT (1/4" - 20)	4	ALL MODELS (NON-PTFE COATED)	12600-26	Stainless Steel
18	HEX NUT (5/16" - 18)	16	ALL MODELS (NON-PTFE COATED)	12601-26	Stainless Steel
19	O-RING (Manifolds)	4	S100-*P*-***N-*** S100-*P*-***E-*** S100-*P*-***T-*** S100-*P*-***V-***	11940-11 11940-15 11940-17 11940-82	Nitrile EPDM PTFE Viton®/FKM
20	BOLT (3/8" X 2-1/4")	16	ALL MODELS (NON-PTFE COATED)	12544-26	Stainless Steel
21	HEX NUT (3/8" - 16)	16	ALL MODELS (NON-PTFE COATED)	12602-26	Stainless Steel
23	SUCTION MANIFOLD	1	S100-*PP-****-*** S100-*PK-****-***	10555-40 10555-56	Polypropylene PVDF
24	SELF TAP SCREW (#6 X 1/2")	6	ALL MODELS	12510-26	Stainless Steel
25	LOCK WASHER	4	ALL MODELS	12350-26	Stainless Steel
28	OUTER CHAMBER	2	S100-*PP-****-*** S100-*PK-****-***	10723-40 10723-56	Polypropylene PVDF
29	OUTER DIAPHRAGM PLATE	2	S100-*PP-****-*** S100-*PK-****-***	11204-40 11204-56	Polypropylene PVDF
30	OVERLAY (PTFE ONLY)	2	S100-*P*-T***-***	11406-59	PTFE
31	DIAPHRAGM	2	S100-*P*-V***-*** S100-*P*-G***-*** S100-*P*-S***-*** S100-*P*-T***-***	10605-13 10605-19 10605-23 10605-23	Viton®/FKM Geolast® Santoprene® Santoprene®
32	DISCHARGE MANIFOLD	1	S100-*PP-****-*** S100-*PK-****-***	10567-40 10567-56	Polypropylene PVDF
33	INNER DIAPHRAGM PLATE	2	ALL MODELS	11104-25	Plated Steel
34	INTERMEDIATE	1	ALL MODELS	11522-60	Polypropylene
36	MUFFLER PLATE	1	ALL MODELS	13111-60	Polypropylene



# PARTS LIST - BOLTED PLASTIC

## S100-\*P\*-\*\*\*\*-\*\*\*\*

ITEM	DESCRIPTION	QTY	PUMP MODEL	PART NO.	MATERIAL
37	MUFFLER	1	ALL MODELS	13000-00	Polypropylene
39	GASKET (Muffler Plate)	1	ALL MODELS	12117-19	Nitrile
40	LIP SEAL (Diaphragm Rod)	2	ALL MODELS	12000-76	Nitrile
41	RETAINING PLATE	2	ALL MODELS	12708-54	Polypropylene
42	O-RING (End Spacer)	2	ALL MODELS	11923-11	Nitrile
43	LIP SEAL (Air Valve)	2	ALL MODELS	12003-76	Nitrile
44	O-RING (Air Valve End Plug)	1	ALL MODELS	11913-11	Nitrile
45	PILOT SLEEVE	1	ALL MODELS	10105-31	Acetal
46	O-RING (Pilot Sleeve)	4	ALL MODELS	11920-16	Urethane
47	INNER SPACER (Pilot Sleeve)	3	ALL MODELS	10203-40	Polypropylene
48	MAX-PASS™ VALVE	4	S100-*P*-*N**-* S100-*P*-*E**-* S100-*P*-*V**-*	10911-11 10911-15 10911-82	Nitrile EPDM Viton®/FKM
49	MAX-PASS™ BACK-UP	4	S100-*PP-*P*-* S100-*PK-*K*-*	10912-40 10912-56	Polypropylene PVDF
50	O-RING (Max-Pass™ Valve)	4	S100-*P*-*N**-* S100-*P*-*E**-* S100-*P*-*V**-*	11936-11 11936-15 11936-82	Nitrile EPDM Viton®/FKM

\* Any Character

\* NOTE: DIAPHRAGM ROD CAN ONLY BE PURCHASED AS AN ASSEMBLY.

DIAPHRAGM ROD ASSEMBLY Items 13 & 15	1	ALL MODELS	32000-00	Stainless Steel
---	---	------------	----------	-----------------

### OPTIONAL ASSEMBLIES AVAILABLE

AIR VALVE ASSEMBLY Items 1, 2, 4, 5, 6, 7, 43, 44	1	ALL MODELS	SMK-100-P	Various
--	---	------------	-----------	---------

PILOT VALVE ASSEMBLY Items 14, 40, 42, 45, 46, 47	1	ALL MODELS	SPK-100-P	Various
--	---	------------	-----------	---------