

EOM

ENGINEERING OPERATION
& MAINTENANCE MANUAL

P400 Bolted Plastic Pump



Where Innovation Flows

WILDEN®

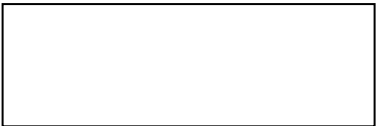

Copyright

Copyright 2018 PSG®, a Dover Company. All rights reserved.

PSG reserves the right to modify the information and illustrations in this document without prior notice. The product described in this document is furnished under a license agreement or nondisclosure agreement. No part of this document may be reproduced, stored in a retrieval system, or transmitted in any form or any means electronic or mechanical, including photocopying and recording, without the written permission of PSG, a Dover Company, except as described by the terms of those agreements.

This is a non-contractual document.

Trademarks

PSG and the PSG logo are registered trademarks of PSG. Wilden® is a registered trademark of PSG California LLC. Pro-Flo® SHIFT and Pro-Flo® are registered trademarks of PSG California LLC. Wil-Flex® is a trademark of PSG California LLC. Saniflex™ is a trademark of PSG California LLC.

All trademarks, names, logos and service marks (collectively “trademarks”) in this document are registered and unregistered trademarks of their respective owners. Nothing contained in this document should be construed as granting any license or right to use any trademark without the prior written permission of the trademark owner.

Warranty

Each and every product manufactured by Wilden is built to meet the highest standards of quality. Every pump is functionally tested to ensure integrity of operation. Wilden warrants that pumps, accessories and parts manufactured or supplied by it to be free from defects in material and workmanship for a period of five (5) years from date of installation or six (6) years from date of manufacture, whichever comes first.

For more information, and to register your Wilden pump for warranty, please visit <https://www.psgdover.com/wilden/support/warranty-registration>.

Certifications



CONTENTS

SECTION 1: Precautions – Read First! 4

SECTION 2: Wilden Pump Designation System 5

SECTION 3: How It Works 6

SECTION 4: Dimensional Drawings 7

SECTION 5: Performance 8

 P400 Plastic Rubber-Fitted 8

 P400 Plastic TPE-Fitted 8

 P400 Plastic Reduced-Stroke PTFE-Fitted 9

 P400 Plastic Full-Stroke PTFE-Fitted 9

 Suction Lift Capability 10

SECTION 6: Suggested Installation, Operation, Maintenance, and Troubleshooting 11

SECTION 7: Disassembly/Reassembly 14

 Pump Disassembly 14

 Air Valve Disassembly 17

 Reassembly Hints and Tips 19

 Shaft Seal Installation 20

SECTION 8: Exploded View and Parts List 21

SECTION 9: Elastomer Options 23

SECTION 1

PRECAUTIONS – READ FIRST!



WARNING: Always wear safety glasses when operating a pump to avoid eye injury. If diaphragm rupture occurs, material being pumped may be forced out of the air exhaust.



CAUTION: Do not apply compressed air to the exhaust port – pump will not function.



CAUTION: Do not over-lubricate air supply– excess lubrication will reduce pump performance. Pump is pre-lubed.



TEMPERATURE LIMITS:

| | | |
|--------------------------------|----------------|----------------|
| Acetal | -29°C to 82°C | -20°F to 180°F |
| Buna-N | -12°C to 82°C | 10°F to 180°F |
| Geolast® | -40°C to 82°C | -40°F to 180°F |
| Neoprene | -18°C to 93°C | 0°F to 200°F |
| Nordel EPDM | -51°C to 138°C | -60°F to 280°F |
| Nylon | -18°C to 93°C | 0°F to 200°F |
| PFA | -7°C to 107°C | 45°F to 225°F |
| Polypropylene | 0°C to 79°C | 32°F to 175°F |
| Polyurethane | -12°C to 66°C | 10°F to 150°F |
| PVDF | -12°C to 107°C | 10°F to 225°F |
| Saniflex | -29°C to 104°C | -20°F to 220°F |
| SIPD PTFE with EPDM-backed | 4°C to 137°C | 40°F to 280°F |
| SIPD PTFE with Neoprene-backed | 4°C to 93°C | 40°F to 200°F |
| PTFE* | 4°C to 104°C | 40°F to 220°F |
| FKM | -40°C to 177°C | -40°F to 350°F |
| Wil-Flex | -40°C to 107°C | -40°F to 225°F |

*4°C to 149°C (40°F to 300°F) - 13 mm (1/2") and 25 mm (1") models only.

NOTE: Not all materials are available for all models. See "Wilden Pump Designation System" material options for your pump.



CAUTION: When choosing pump materials, be sure to check the temperature limits for all wetted components. Example: FKM has a maximum limit of 177°C (350°F), but polypropylene has a maximum limit of only 79°C (175°F).



CAUTION: Maximum temperature limits are based on mechanical stress only. Certain chemicals will reduce maximum safe operating temperatures significantly. Consult the Chemical Resistance Guide for chemical compatibility and temperature limits.



CAUTION: All Wilden pumps are capable of passing solids. Use a strainer on the pump intake to ensure that the pump's rated solids capacity is not exceeded.



CAUTION: Do not exceed 8.6 bar (125 psig) air supply pressure.



CAUTION: Do not exceed 82°C (180°F) air inlet temperature for all models.



CAUTION: The process fluid and cleaning fluids must be compatible chemically with all wetted pump components.



CAUTION: Thoroughly flush pumps before installing them into process lines. Clean and/or sanitize FDA- and USDA- approved pumps before using them.



CAUTION: Before attempting any maintenance or repair, disconnect the compressed air line to the pump and allow all air pressure to bleed from the pump. Disconnect all intake, discharge, and air lines. Drain the pump by turning it upside down and allowing any fluid to flow into a suitable container. Be aware of any hazardous effects of contact with your process fluid.



CAUTION: Before attaching the air line to the pump, blow out the air line for 10 to 20 seconds to make sure all pipeline debris is clear. Use an in-line air filter. A 5µ (micron) air filter is recommended.



CAUTION: Pro-Flo pumps cannot be used in submersible applications.



CAUTION: Before installation, tighten all hardware.



NOTE: Materials of construction and elastomer material may influence suction lift parameters. Please refer to "Performance" for specifics.



NOTE: When installing PTFE diaphragms, it is important to tighten outer pistons simultaneously (turning in opposite directions) to ensure tight fit. (See "Maximum Torque Specifications").



NOTE: Some PTFE-fitted pumps come standard from the factory with expanded PTFE gaskets installed in the diaphragm bead of the liquid chamber. PTFE gaskets cannot be re-used.



NOTE: In the event of a power failure, close the shut-off valve if you do not want the pump to restart when the power returns.



WARNING: This product can expose you to chemicals including Nickel, Chromium, Cadmium, or Cobalt, which are known to the State of California to cause cancer and/or birth defects or other reproductive harm. For more information, go to www.P65Warnings.ca.gov.

SECTION 2

WILDEN PUMP DESIGNATION SYSTEM

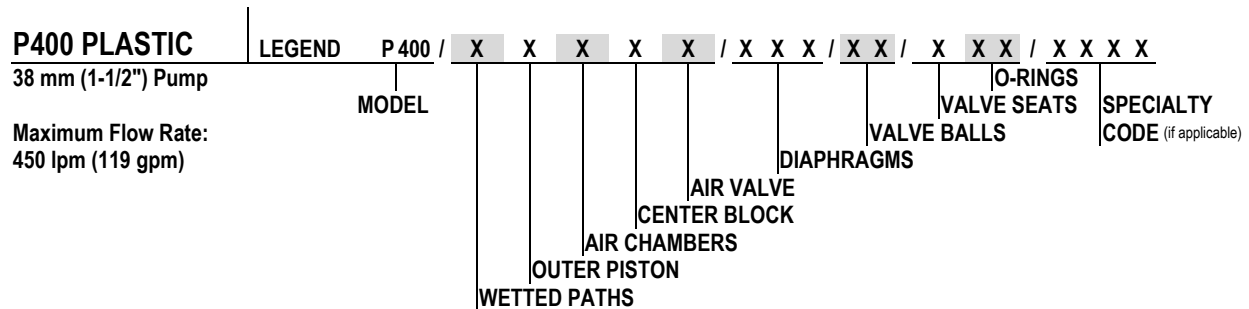

MATERIAL CODES

| | | |
|---|---|---|
| MODEL P400 = PRO-FLO® PLASTIC | DIAPHRAGMS BNS = BUNA-N (RED DOT) EPS = EPDM (BLUE DOT) FWL = FULL-STROKE SANITARY WIL-FLEX™, IPD [SANTOPRENE® (THREE BLACK DOTS)] NES = NEOPRENE (GREEN DOT) SSL = FULL-STROKE SANIFLEX™ IPD [HYTREL® (CREAM)] TEU = PTFE W/EPDM BACKUP (WHITE) TNU = PTFE W/NEOPRENE BACKUP (WHITE) TSS = FULL-STROKE PTFE W/SANIFLEX™ BACK-UP TSU = PTFE W/SANIFLEX™ BACK-UP (WHITE) TWS = FULL-STROKE PTFE W/WIL-FLEX™ BACKUP VTS = FKM (WHITE DOT) ZGS = GEOLAST®, EZ-INSTALL ZPS = POLYURETHANE, EZ-INSTALL ZSS = SANIFLEX™, EZ-INSTALL WWL = FULL-STROKE WIL-FLEX™ IPD [SANTOPRENE® (THREE BLACK DOTS)] ZWS = WIL-FLEX™, EZ-INSTALL | VALVE BALLS BN = BUNA-N (RED DOT) EP = EPDM (BLUE DOT) FS = SANIFLEX™ [HYTREL® (CREAM)] FW = SANITARY WIL-FLEX™ [SANTOPRENE® (TWO BLACK DOTS)] NE = NEOPRENE (GREEN DOT) PU = POLYURETHANE (BROWN) TF = PTFE (WHITE) VT = FKM (SILVER OR WHITE DOT) WF = WIL-FLEX™ [SANTOPRENE® (THREE BLACK DOTS)] |
| WETTED PATH K = PVDF P = POLYPROPYLENE | | VALVE SEATS K = PVDF P = POLYPROPYLENE |
| OUTER PISTON K = PVDF P = POLYPROPYLENE Z = NO OUTER PISTON | | VALVE SEATS & MANIFOLD O-RING BN = BUNA-N TV = PTFE ENCAP, FKM WF = WIL-FLEX™ [SANTOPRENE®] |
| AIR CHAMBERS P = POLYPROPYLENE | | |
| CENTER BLOCK P = POLYPROPYLENE | | |
| AIR VALVE P = POLYPROPYLENE | | |

SPECIALTY CODES

| | |
|-------------------------------------|--------------------------------------|
| 0100 Wil-Gard II™ 110V | 0506 DIN flange, PFA coated hardware |
| 0102 Wil-Gard II™ sensor wires Only | 0604 DIN flange, Wil-Gard II™ 220V |
| 0103 Wil-Gard II™ 220V | |
| 0502 PFA coated hardware | |
| 0504 DIN flange | |

! NOTE: Most elastomeric materials use colored dots for identification. **! NOTE:** Not all models are available with all material options

SECTION 3

HOW IT WORKS – AIR-OPERATED DOUBLE-DIAPHRAGM PUMP

The Wilden diaphragm pump is an air-operated, positive displacement, self-priming pump. These drawings show flow pattern through the pump upon its initial stroke. It is assumed the pump has no fluid in it prior to its initial stroke.

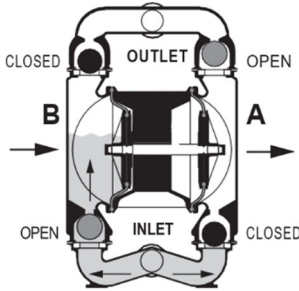

FIGURE 1 The air valve directs pressurized air to the back side of diaphragm A. The compressed air is applied directly to the liquid column separated by elastomeric diaphragms. The diaphragm acts as a separation membrane between the compressed air and liquid; a balanced load removes mechanical stress from the diaphragm. The compressed air moves the diaphragm away from the center of the pump. The opposite diaphragm is pulled in by the shaft connected to the pressurized diaphragm. Diaphragm B is on its suction stroke; air behind the diaphragm has been forced out to atmosphere through the exhaust port of the pump. The movement of diaphragm B toward the center of the pump creates a vacuum within chamber B. Atmospheric pressure forces fluid into the inlet manifold forcing the inlet valve ball off its seat. Liquid is free to move past the inlet valve ball and fill the liquid chamber (see shaded area).

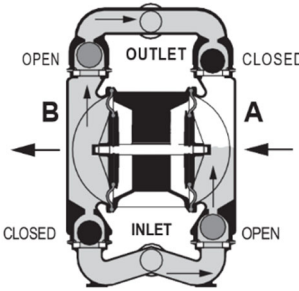

FIGURE 2 When the pressurized diaphragm, diaphragm A, reaches the limit of its discharge stroke, the air valve redirects pressurized air to the back side of diaphragm B. The pressurized air forces diaphragm B away from the center while pulling diaphragm A to the center. Diaphragm B is now on its discharge stroke. Diaphragm B forces the inlet valve ball onto its seat due to the hydraulic forces developed in the liquid chamber and manifold of the pump. These same hydraulic forces lift the discharge valve ball off its seat, while the opposite discharge valve ball is forced onto its seat, forcing fluid to flow through the pump discharge. The movement of diaphragm A toward the center of the pump creates a vacuum within liquid chamber A. Atmospheric pressure forces fluid into the inlet manifold of the pump. The inlet valve ball is forced off its seat allowing the fluid being pumped to fill the liquid chamber.

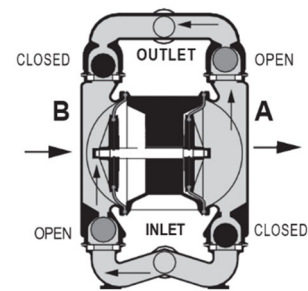
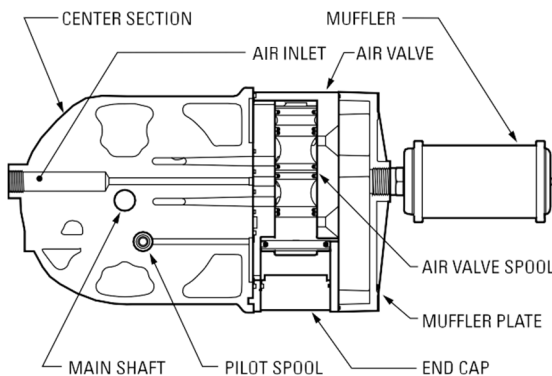

FIGURE 3 At completion of the stroke, the air valve again redirects air to the back side of diaphragm A, which starts diaphragm B on its exhaust stroke. As the pump reaches its original starting point, each diaphragm has gone through one exhaust and one discharge stroke. This constitutes one complete pumping cycle. The pump may take several cycles to completely prime depending on the conditions of the application.

HOW IT WORKS – AIR DISTRIBUTION SYSTEM



The Pro-Flo® patented air distribution system incorporates two moving parts: the air valve spool and the pilot spool. The heart of the system is the air valve spool and air valve. This valve design incorporates an unbalanced spool. The smaller end of the spool is pressurized continuously, while the large end is alternately pressurized then exhausted to move the spool. The spool directs pressurized air to one air chamber while exhausting the other. The air causes the main shaft/diaphragm assembly to shift to one side — discharging liquid on that side and pulling liquid in on the other side. When the shaft reaches the end of its stroke, the inner piston actuates the pilot spool, which pressurizes and exhausts the large end of the air valve spool. The repositioning of the air valve spool routes the air to the other air chamber

SECTION 4

DIMENSIONAL DRAWING

P400 Plastic – Polypropylene

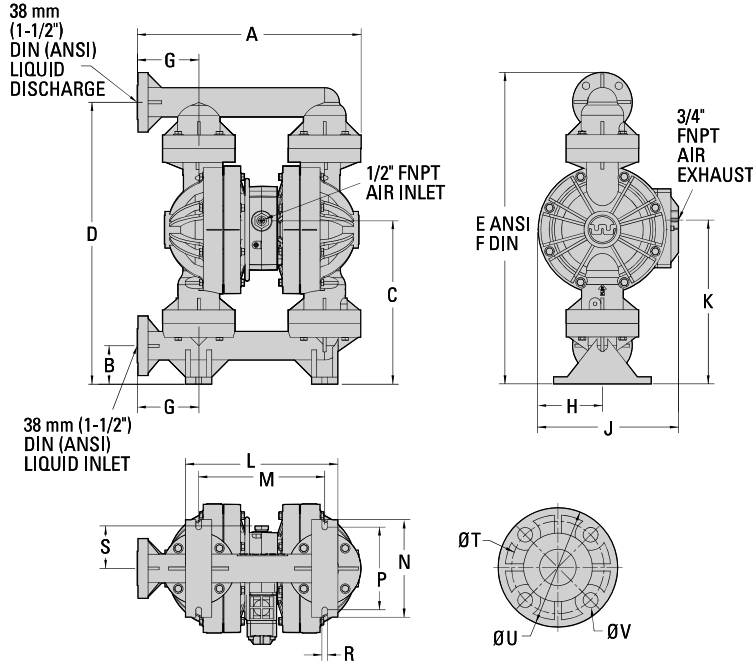

DIMENSIONS

| ITEM | METRIC (mm) | STANDARD (inch) |
|--------------------|-------------|-----------------|
| A | 476 | 18.8 |
| B | 81 | 3.2 |
| C | 348 | 13.7 |
| D | 602 | 23.7 |
| E | 665 | 26.2 |
| F | 677 | 26.6 |
| G | 131 | 5.2 |
| H | 138 | 5.4 |
| J | 300 | 11.8 |
| K | 351 | 13.8 |
| L | 324 | 12.8 |
| M | 268 | 10.6 |
| N | 208 | 8.2 |
| P | 176 | 6.9 |
| R | 12 | 0.5 |
| S | 91 | 3.6 |
| DIN FLANGE | | |
| T | 110 DIA. | 4.3 DIA. |
| U | 150 DIA. | 5.9 DIA. |
| V | 18 DIA. | 0.7 DIA. |
| ANSI FLANGE | | |
| T | 98 DIA. | 3.9 DIA. |
| U | 127 DIA. | 5.0 DIA. |
| V | 16 DIA. | 0.6 DIA. |

LW0324 REV. A

P400 Plastic – PVDF

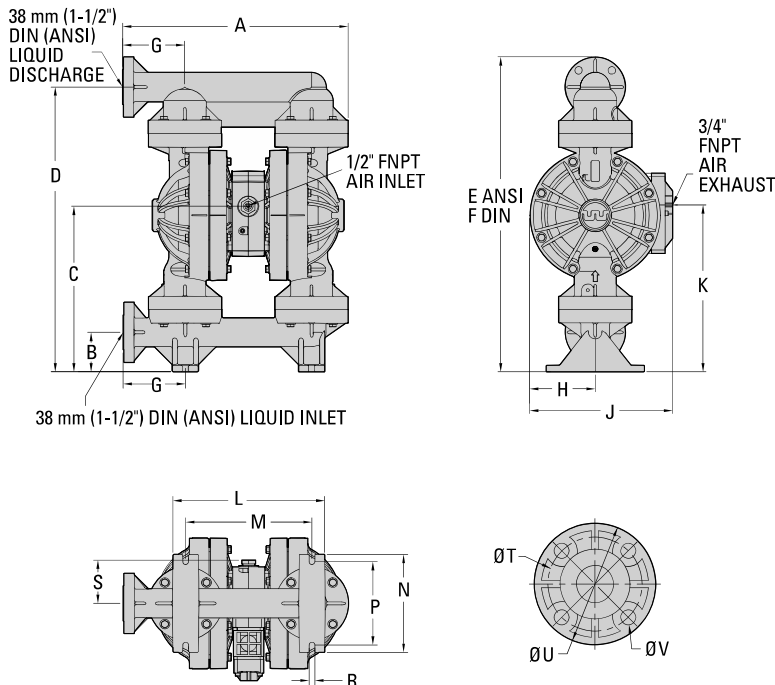

DIMENSIONS

| ITEM | METRIC (mm) | STANDARD (inch) |
|--------------------|-------------|-----------------|
| A | 471 | 18.5 |
| B | 83 | 3.2 |
| C | 345 | 13.6 |
| D | 596 | 23.4 |
| E | 659 | 25.9 |
| F | 670 | 26.4 |
| G | 130 | 5.1 |
| H | 137 | 5.4 |
| J | 300 | 11.8 |
| K | 348 | 13.7 |
| L | 319 | 12.6 |
| M | 264 | 10.4 |
| N | 205 | 8.1 |
| P | 174 | 6.9 |
| R | 12 | 0.5 |
| S | 91 | 3.6 |
| DIN FLANGE | | |
| T | 110 DIA. | 4.3 DIA. |
| U | 149 DIA. | 5.9 DIA. |
| V | 18 DIA. | 0.7 DIA. |
| ANSI FLANGE | | |
| T | 98 DIA. | 3.9 DIA. |
| U | 126 DIA. | 5.0 DIA. |
| V | 16 DIA. | 0.6 DIA. |

LW0325 REV. A

SECTION 5

PERFORMANCE

P400 PLASTIC RUBBER-FITTED

Ship Weights.....Polypropylene 19 kg (41 lb)
PVDF 27 kg (59 lb)
Air Inlet.....13 mm (1/2")
Inlet.....38 mm (1-1/2")
Outlet.....38 mm (1-1/2")
Suction Lift.....5.5 m Dry (18.5')
9.0 m Wet (29.5')
Disp. per Stroke¹.....1.25 L (.330 gal)
Max. Flow Rate.....454 lpm (120 gpm)
Max. Size Solids.....6.4 mm (1/4")

¹Displacement per stroke was calculated at 4.8 bar (70 psig) air inlet pressure against a 2 bar (30 psig) head pressure.

Example: To pump 227 lpm (60 gpm) against a discharge head pressure of 5.0 bar (73 psig) requires 6.9 bar (100 psig) and 136 Nm³/h (80 scfm) air consumption

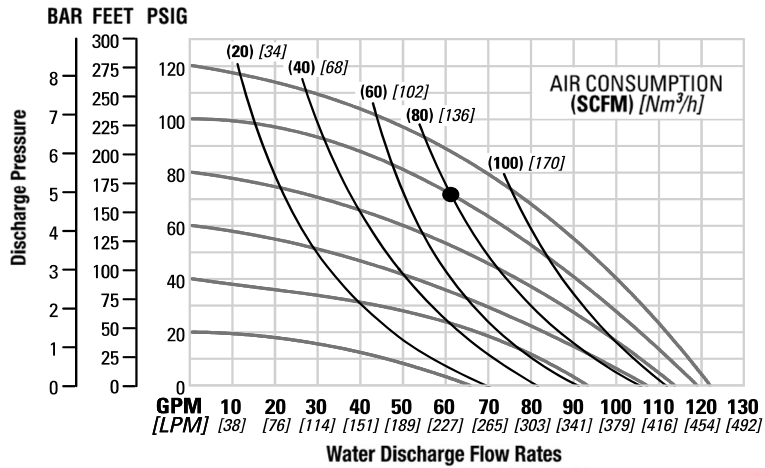

Flow rates indicated on chart were determined by pumping water. For optimum life and performance, pumps should be specified so that daily operation parameters will fall in the center of the pump's performance curve.

Caution: Do not exceed 8.6 bar (125 psig) air supply pressure.

P400 PLASTIC TPE-FITTED

Ship Weights.....Polypropylene 19 kg (41 lb)
PVDF 27 kg (59 lb)
Air Inlet.....13 mm (1/2")
Inlet.....38 mm (1-1/2")
Outlet.....38 mm (1-1/2")
Suction Lift.....4.8 m Dry (15.9')
9.3 m Wet (30.6')
Disp. per Stroke¹.....1.34 L (0.353 gal)
Max. Flow Rate.....454 lpm (120 gpm)
Max. Size Solids.....6.4 mm (1/4")

¹Displacement per stroke was calculated at 4.8 bar (70 psig) air inlet pressure against a 2 bar (30 psig) head pressure.

Example: To pump 151 lpm (40 gpm) against a discharge head pressure of 4.3 bar (63 psig) requires 5.5 bar (80 psig) and 68 Nm³/h (40 scfm) air consumption

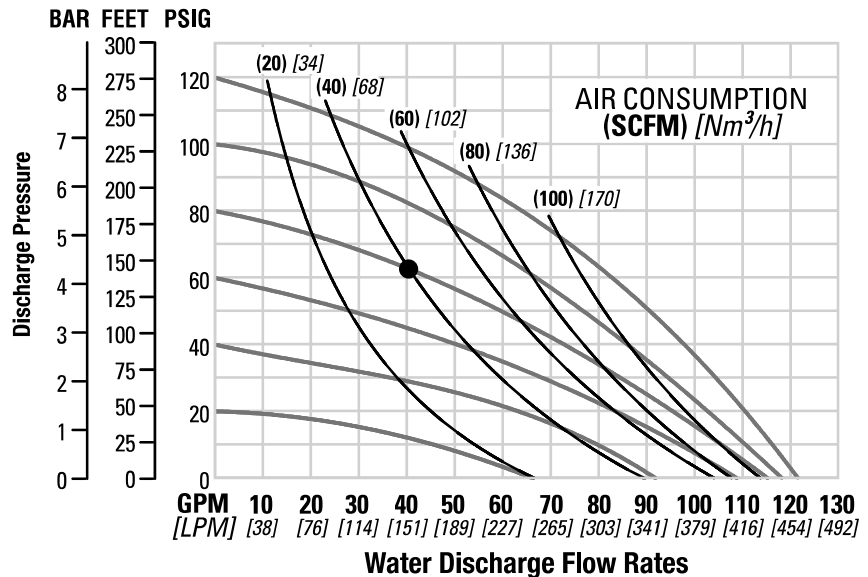

Flow rates indicated on chart were determined by pumping water. For optimum life and performance, pumps should be specified so that daily operation parameters will fall in the center of the pump's performance curve.

Caution: Do not exceed 8.6 bar (125 psig) air supply pressure.

PERFORMANCE

**P400 PLASTIC
REDUCED-STROKE
PTFE-FITTED**

Ship Weights.....Polypropylene 19 kg (41 lb)
PVDF 27 kg (59 lb)
Air Inlet.....13 mm (1/2")
Inlet.....38 mm (1-1/2")
Outlet.....38 mm (1-1/2")
Suction Lift.....3.3 m Dry (10.8')
9.7 m Wet (31.8')
Disp. per Stroke¹.....0.59 L (0.155 gal)
Max. Flow Rate.....318 lpm (84 gpm)
Max. Size Solids.....6.4 mm (1/4")

¹Displacement per stroke was calculated at 4.8 bar (70 psig) air inlet pressure against a 2 bar (30 psig) head pressure.

Example: To pump 178 lpm (47 gpm) against a discharge head pressure of 3.4 bar (50 psig) requires 5.5 bar (80 psig) and 136 Nm³/h (80 scfm) air consumption.

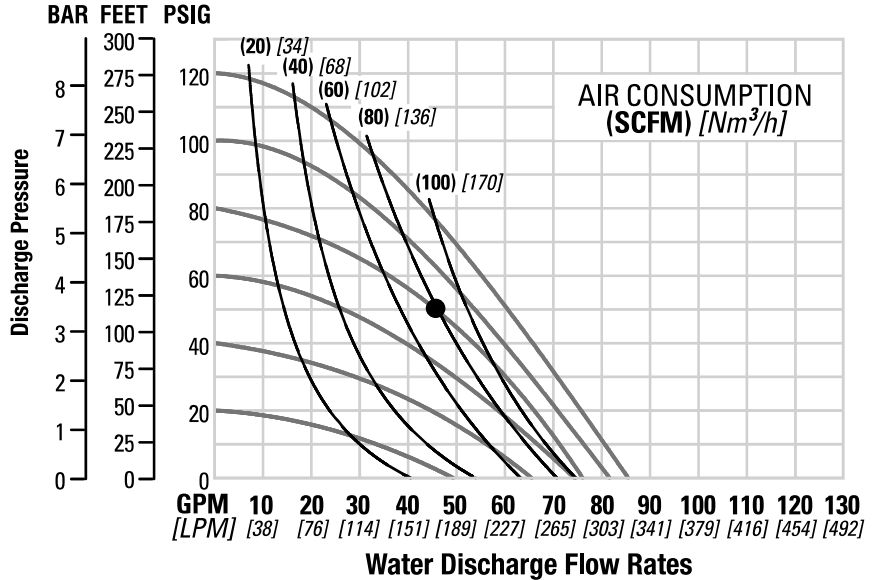

Flow rates indicated on chart were determined by pumping water. For optimum life and performance, pumps should be specified so that daily operation parameters will fall in the center of the pump's performance curve.

Caution: Do not exceed 8.6 bar (125 psig) air supply pressure.

**P400 PLASTIC
FULL-STROKE
PTFE-FITTED**

Ship Weights.....Polypropylene 19 kg (41 lb)
PVDF 27 kg (59 lb)
Air Inlet.....13 mm (1/2")
Inlet.....38 mm (1-1/2")
Outlet.....38 mm (1-1/2")
Suction Lift.....3.3 m Dry (10.8')
9.7 m Wet (31.8')
Disp. per Stroke¹.....0.59 L (0.155 gal)
Max. Flow Rate.....318 lpm (84 gpm)
Max. Size Solids.....6.4 mm (1/4")

¹Displacement per stroke was calculated at 4.8 bar (70 psig) air inlet pressure against a 2.1 bar (30 psig) head pressure.

Example: To pump 337 lpm (89 gpm) against a discharge head of 1.4 bar (20 psig) requires 5.5 bar (80 psig) and 147 Nm³/h (93 scfm) air consumption.

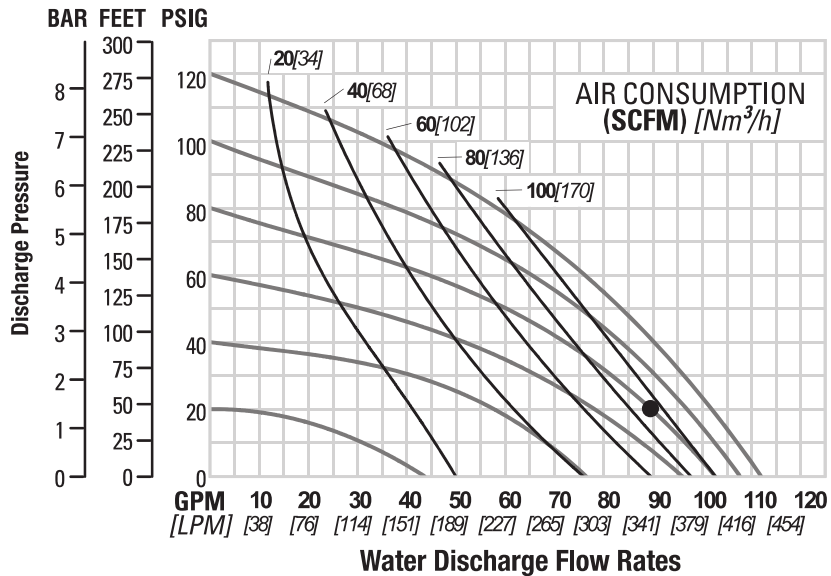

Flow rates indicated on chart were determined by pumping water. For optimum life and performance, pumps should be specified so that daily operation parameters will fall in the center of the pump's performance curve.

Caution: Do not exceed 8.6 bar (125 psig) air supply pressure.

SECTION 5

SUCTION LIFT CAPABILITY

P400 PLASTIC SUCTION LIFT CAPABILITY

Suction-lift curves are calibrated for pumps operating at 305 m (1,000') above sea level. This chart is meant to be a guide only. There are many variables that can affect your pump's operating characteristics. The number of intake and discharge elbows, viscosity of pumping fluid, elevation (atmospheric pressure) and pipe friction loss all affect the amount of suction lift your pump will attain.

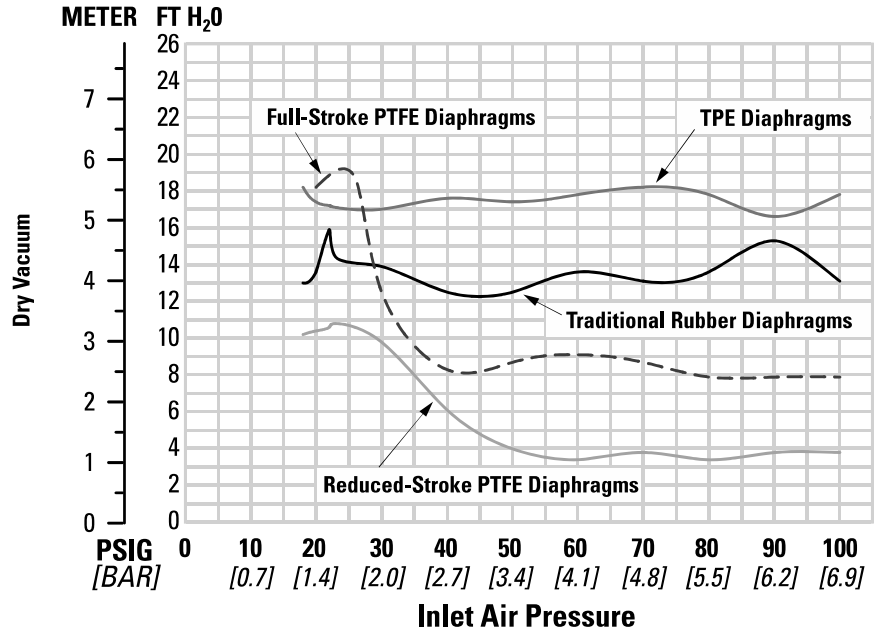

SECTION 6

**SUGGESTED INSTALLATION, OPERATION, MAINTENANCE
AND TROUBLESHOOTING**

Wilden pumps are designed to meet the performance requirements of even the most demanding pumping applications. They have been designed and manufactured to the highest standards and are available in a variety of liquid path materials to meet your chemical resistance needs. Refer to "Performance" for an in-depth analysis of the performance characteristics of your pump. Wilden offers the widest variety of elastomer options in the industry to satisfy temperature, chemical compatibility, abrasion resistance and flex concerns.

The suction pipe size should be at least equal to or larger than the diameter size of the suction inlet on your Wilden pump. The suction hose must be a non-collapsible, reinforced type because these pumps are capable of pulling a high vacuum. Discharge piping should also be equal to or larger than the diameter of the pump discharge, which will help reduce friction losses.

 **CAUTION:** All fittings and connections must be airtight. Otherwise, pump suction capability will be reduced or lost.

Months of careful planning, study and selection efforts can result in unsatisfactory pump performance if installation details are left to chance. You can avoid premature failure and long-term dissatisfaction by exercising reasonable care throughout the installation process.

Location

Noise, safety and other logistical factors usually dictate where equipment will be situated on the production floor. Multiple installations with conflicting requirements can result in congestion of utility areas, leaving few choices for additional pumps. Within the framework of these and other existing conditions, locate every pump in such a way that the following six key factors are balanced against each other to maximum advantage:

- **Access:** First, the location should be accessible. If it's easy to reach the pump, maintenance personnel will be able to perform routine inspections and adjustments more easily. If major repairs become necessary, ease of access can play a key role in speeding the repair process and reducing total downtime.
- **Air Supply:** Every pump location should have an air line large enough to supply the volume of air necessary to achieve the desired pumping rate. For best results, the pumps should use a 5µ (micron) air filter, needle valve and regulator. The use of an air filter before the pump will ensure that the majority of any pipeline contaminants will be eliminated.
- **Solenoid Operation:** When operation is controlled by a solenoid valve in the air line, three-way valves should be used. This valve allows trapped air between the valve and the pump to bleed off, which improves pump performance. You can estimate pumping volume by counting the number of strokes per minute, and then multiplying that figure by the displacement per stroke.
- **Muffler:** Using the standard Wilden muffler, sound levels are reduced below OSHA specifications. You can use other mufflers to reduce sound levels farther, but they usually reduce pump performance.
- **Elevation:** Selecting a site that is well within the pump's dynamic lift capability will assure that loss-of-prime issues will

be eliminated. In addition, pump efficiency can be adversely affected if proper attention is not given to site location.

- **Piping:** Final determination of the pump site should not be made until the piping challenges of each possible location have been evaluated. The impact of current and future installations should be considered ahead of time to make sure that inadvertent restrictions are not created for any remaining sites.

The best choice possible will be a site involving the shortest and straightest hook-up of suction and discharge piping. Unnecessary elbows, bends and fittings should be avoided. Pipe sizes should be selected to keep friction losses within practical limits. All piping should be supported independently of the pump. In addition, the piping should be aligned to avoid placing stress on the pump fittings.

Flexible hose can be installed to aid in absorbing the forces created by the natural reciprocating action of the pump. If the pump is to be bolted down to a solid location, a mounting pad placed between the pump and the foundation will assist in minimizing pump vibration. Flexible connections between the pump and rigid piping will also assist in minimizing pump vibration. If quick-closing valves are installed at any point in the discharge system, or if pulsation within a system becomes a problem, a surge suppressor (SD Equalizer) should be installed to protect the pump, piping and gauges from surges and water hammer.

If the pump is to be used in a self-priming application, make sure that all connections are airtight and that the suction lift is within the model's ability.

 **NOTE:** Materials of construction and elastomer material have an effect on suction lift parameters. Please refer to "Performance" for specifics.

When pumps are installed in applications involving flooded suction or suction head pressures, a gate valve should be installed in the suction line to permit closing of the line for pump service.

Pumps in service with a positive suction head are most efficient when inlet pressure is limited to 0.5–0.7 bar (7–10 psig). Premature diaphragm failure may occur if positive suction is 0.7 bar (10 psig) and higher.

 **CAUTION:** All Wilden pumps are capable of passing solids. Use a strainer on the pump intake to ensure that the pump's rated solids capacity is not exceeded.

 **CAUTION:** Do not exceed 8.6 bar (125 psig) air supply pressure.

 **CAUTION:** Pro-Flo® pumps are not submersible.

SUGGESTED INSTALLATION, OPERATION, MAINTENANCE AND TROUBLESHOOTING

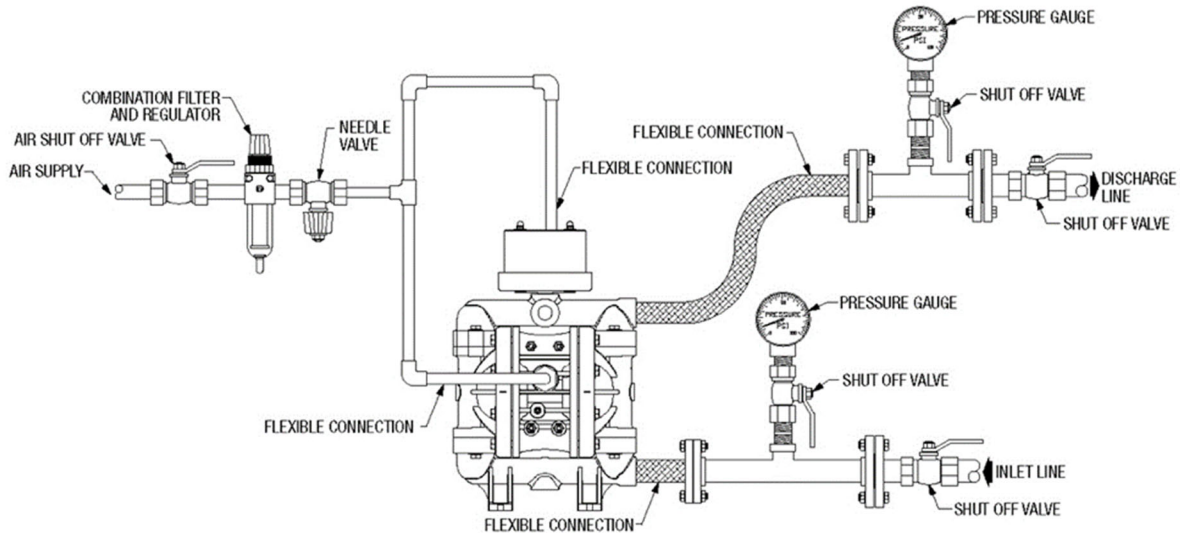

! **NOTE:** In the event of a power failure, close the shut-off valve if you do not want the pump to restart when the power returns.

Air-Operated Pumps: To stop the pump from operating in an emergency, simply close the shut-off valve (user-supplied) installed in the air supply line. A properly functioning valve will stop the air supply to the pump, therefore stopping output. This shut-off valve should be located far enough away from the pumping equipment such that it can be reached safely in an emergency.

Operation

The Pro-Flo pumps are pre-lubricated and do not require in-line lubrication. Additional lubrication will not damage the pump. However, if the pump is heavily lubricated by an external source, the pump's internal lubrication may be washed away. If the pump is then moved to a nonlubricated location, it may need to be disassembled and re-lubricated as described in "Disassembly/ Reassembly".

Pump discharge rate can be controlled by limiting the volume and/or pressure of the air supply to the pump. An air regulator is used to regulate air pressure. A needle valve is used to regulate volume. Pump discharge rate also can be controlled by throttling the pump discharge by partially closing a valve in the discharge line of the pump. This action increases friction loss, which reduces flow rate. (See "Performance") This is useful when the need exists to control the pump from a remote location. When the pump discharge pressure equals or exceeds the air supply pressure, the pump will stop. No bypass or pressure relief valve is needed, and

pump damage will not occur. The pump has reached a "deadhead" situation and can be restarted by reducing the fluid discharge pressure or increasing the air inlet pressure. Wilden Pro-Flo pumps run solely on compressed air and do not generate heat. Therefore, your process fluid temperature will not be affected.

Maintenance and Inspections

Because each application is unique, maintenance schedules may be different for every pump. Frequency of use, line pressure, viscosity and abrasiveness of process fluid all affect the parts life of a Wilden pump. Periodic inspections have been found to offer the best means for preventing unscheduled pump downtime. Personnel familiar with the pump's construction and service should be informed of any abnormalities that are detected during operation.

SUGGESTED INSTALLATION, OPERATION, MAINTENANCE AND TROUBLESHOOTING

Troubleshooting

Pump will not run or runs slowly.

1. Remove plug from pilot spool exhaust.
2. Ensure that the air inlet pressure is at least 0.4 bar (5 psig) above startup pressure and that the differential pressure (the difference between air inlet and liquid discharge pressures) is not less than 0.7 bar (10 psig).
3. Check air inlet filter for debris (see "Suggested Installation, Operation, Maintenance and Troubleshooting").
4. Check for extreme air leakage (blow by) that would indicate worn seals/bores in the air valve, pilot spool and main shaft.
5. Disassemble the pump and check for obstructions in the air passageways or objects that would obstruct the movement of internal parts.
6. Check for sticking ball check valves.
 - a. If material being pumped is not compatible with pump elastomers, swelling may occur. Replace ball check valves and seals with proper elastomers.
 - b. Also, as the check valve balls wear out, they become smaller and can become stuck in the seats. In this case, replace balls and seats.
7. Check for any broken inner piston that would cause the air valve spool to be unable to shift.

Pump runs, but little or no product flows.

1. Check for pump cavitation. Slow pump speed down to allow thick material to flow into liquid chambers.
2. Verify that vacuum required to lift liquid is not greater than the vapor pressure of the material being pumped (cavitation).
3. Check for sticking ball check valves.
 - a. If material being pumped is not compatible with pump elastomers, swelling may occur. Replace ball check valves and seals with proper elastomers.
 - b. Also, as the check valve balls wear out, they become smaller and can become stuck in the seats. In this case, replace balls and seats.

Pump air valve freezes.

1. Check for excessive moisture in the compressed air.
 - a. Either install a dryer or a hot air generator for compressed air.
 - b. Alternatively, you may use coalescing filter to remove the water from the compressed air in some applications.

Air bubbles in pump discharge.

1. Check for a ruptured diaphragm.
2. Check tightness of outer pistons (see "Disassembly/Reassembly").
3. Check tightness of fasteners and integrity of O-rings and seals, especially at intake manifold.
4. Ensure pipe connections are airtight.

Product comes out air exhaust.

1. Check for a diaphragm rupture.
2. Check the tightness of the outer pistons to the shaft.

SECTION 7

DISASSEMBLY / REASSEMBLY

PUMP DISASSEMBLY

Tools Required:

- 9/16" Wrench
- Adjustable Wrench
- Vise equipped with soft jaws (such as plywood, plastic or other suitable material)



CAUTION: Before attempting any maintenance or repair, disconnect the compressed air line to the pump and allow all air pressure to bleed from the pump. Disconnect all intake, discharge, and air lines. Drain the pump by turning it upside down and allowing any fluid to flow into a suitable container. Be aware of any hazardous effects of contact with your process fluid.



NOTE: The model used for these instructions incorporates PTFE diaphragms and balls. Models with rubber diaphragms and balls are the same except where noted.



NOTE: Replace worn parts with genuine Wilden parts for reliable performance.

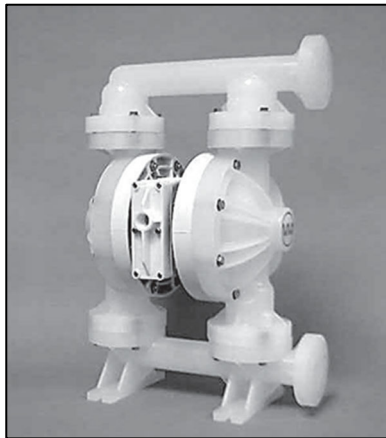

Step 1

Please note alignment marks on liquid chambers. Use to properly align center section with liquid chamber.

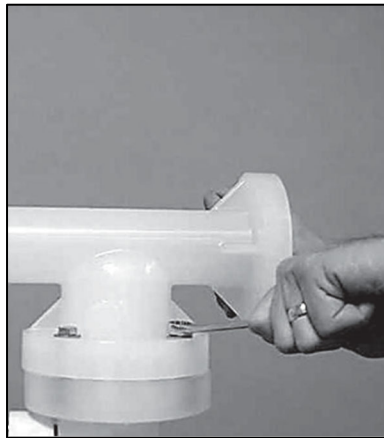

Step 2

Using a 9/16" wrench, loosen the discharge manifold from the liquid chambers.

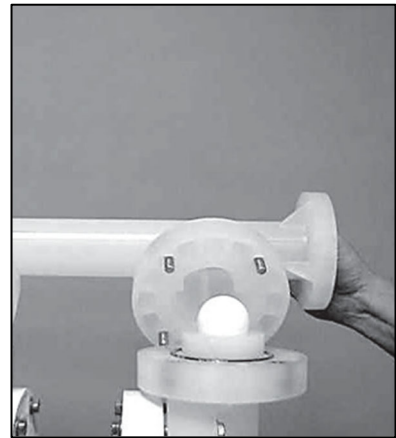

Step 3

Remove the discharge manifold to expose the valve balls, valve seats and valve seat O-rings.

DISASSEMBLY / REASSEMBLY



Step 4

Inspect valve balls, valve seats, and valve seat O-rings for nicks, gouges, chemical attack or abrasive wear.

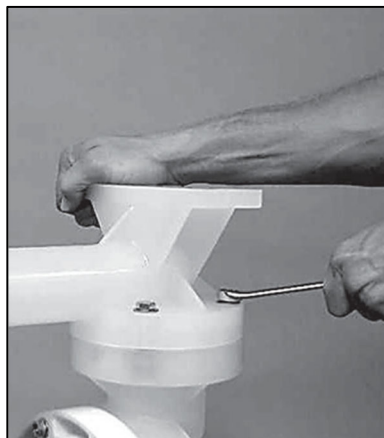

Step 5

Using a 9/16" wrench, loosen the inlet manifold from the liquid chambers.

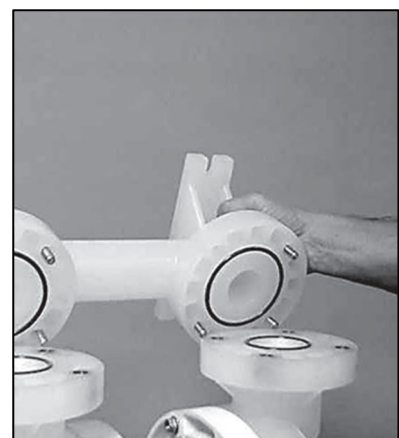

Step 6

Remove the inlet valve balls, seats and valve seat O-rings from the liquid chamber and inlet manifold, inspect for nicks, gouges, chemical attack or abrasive wear.

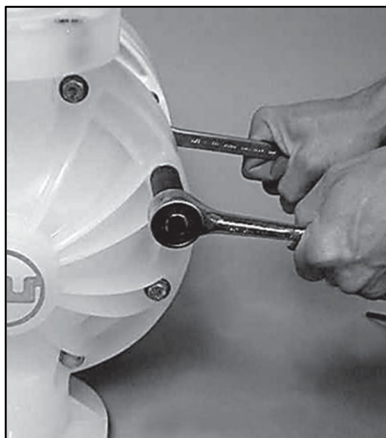

Step 7

Using a 9/16" wrench, remove the liquid chamber fasteners that secure the liquid chamber to the center section.



Step 8

Remove the liquid chamber to expose the diaphragm and outer piston.



Step 9

Using two adjustable wrenches, or rotating both diaphragms by hand (counterclockwise), remove the diaphragm assembly from the center section assembly.

DISASSEMBLY / REASSEMBLY



Step 10

Due to varying torque values, one of the following two situations may occur:

- 1) The outer piston, diaphragm and inner piston remain attached to the shaft and the entire assembly can be removed from the center section.
- 2) The outer piston, diaphragm and inner piston separate from the shaft, which remains connected to the opposite side diaphragm assembly.



Step 11

Remove diaphragm assembly from shaft, secure shaft with soft jaws (a vise fitted with plywood, plastic or other suitable material) to ensure shaft is not nicked, scratched or gouged. Using an adjustable wrench or rotating counterclockwise by hand, remove diaphragm assembly from shaft.

DISASSEMBLY / REASSEMBLY

AIR VALVE DISASSEMBLY

Tools Required:

- 3/16" Allen Wrench
- Snap-Ring Pliers
- O-Ring Pick



CAUTION: Before attempting any maintenance or repair, disconnect the compressed air line to the pump and allow all air pressure to bleed from the pump. Disconnect all intake, discharge, and air lines. Drain the pump by turning it upside down and allowing any fluid to flow into a suitable container. Be aware of any hazardous effects of contact with your process fluid.



NOTE: Replace worn parts with genuine Wilden parts for reliable performance.

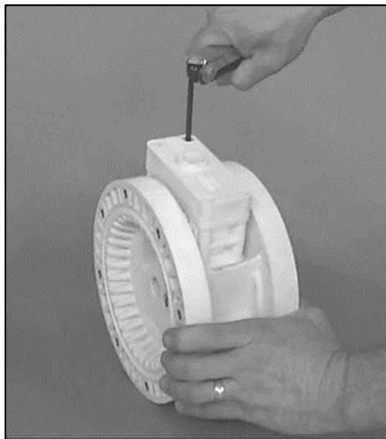

Step 1

Loosen the air valve bolts utilizing a 3/16" Allen wrench.

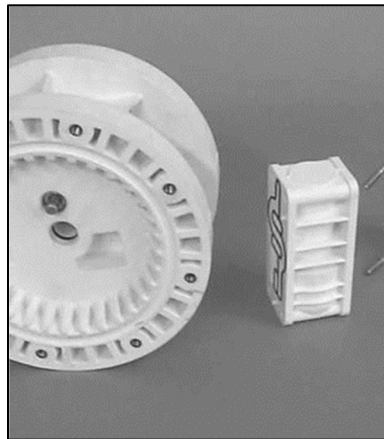

Step 2

Remove muffer plate and air valve bolts from air valve assembly exposing muffer gasket for inspection. Replace if necessary.



Step 3

Lift away air valve assembly and remove air valve gasket for inspection. Replace if necessary.

DISASSEMBLY / REASSEMBLY



Step 4

Remove air valve end cap to expose air valve spool by simply lifting up on end cap once air valve bolts are removed.

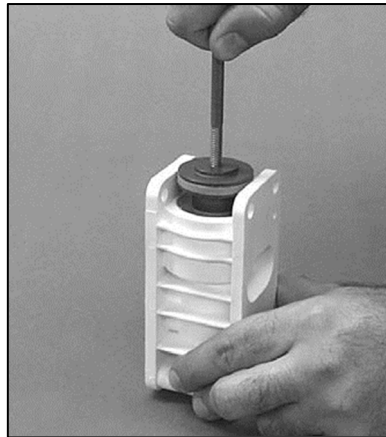

Step 5

Remove air valve spool from air valve body by threading one air valve bolt into the end of the spool and gently sliding the spool out of the air valve body. Inspect seals for signs of wear and replace entire assembly if necessary. Use caution when handling air valve spool to prevent damaging seals.

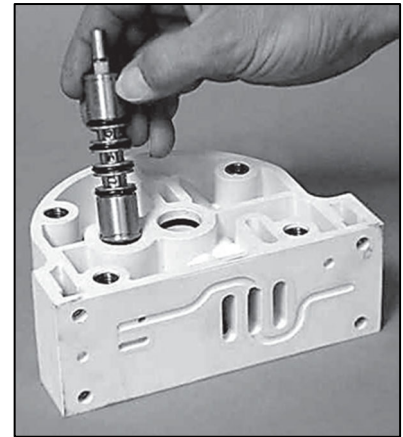

Step 6

Remove pilot spool sleeve retaining snap ring on both sides of center section with snap ring pliers.

NOTE: Seals should not be removed from assembly. Seals are not sold separately.

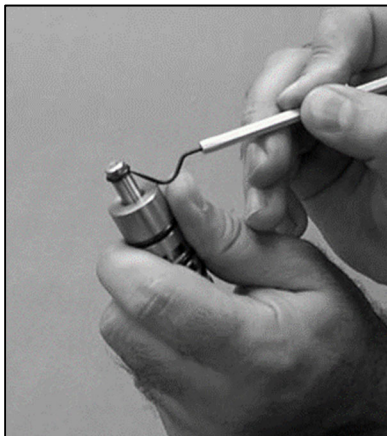

Step 7

With O-ring pick, gently remove the o-ring from the opposite side of the "center hole" cut on the spool. Gently remove the pilot spool from sleeve and inspect for nicks or gouges and other signs of wear. Replace pilot sleeve assembly or outer sleeve O-rings if necessary. During re-assembly never insert the pilot spool into the sleeve with the "center cut" side first, this end incorporates the urethane O-ring and will be damaged as it slides over the ports cut in the sleeve.

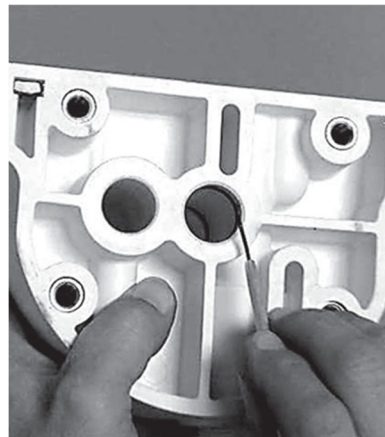

Step 8

Inspect center section seals for signs of wear. If necessary, remove seals with O-ring pick and replace.

DISASSEMBLY / REASSEMBLY

REASSEMBLY HINTS AND TIPS

Upon performing applicable maintenance to the air distribution system, the pump can now be reassembled. Please refer to the disassembly instructions for photos and parts placement.

To reassemble the pump, follow the disassembly instructions in reverse order. The air distribution system needs to be assembled first then the diaphragms and finally the wetted path. The applicable torque specifications are on this page.

The following tips will assist in the assembly process:

- Lubricate air valve bore, center section shaft and pilot spool bore with NLGI grade 2 white EP bearing grease or equivalent.
- Clean the inside of the center section shaft bore to ensure no damage is done to new seals.
- A small amount of NLGI grade 2 white EP bearing grease can be applied to the muffler and air valve gaskets to locate gaskets during assembly.
- Make sure that the exhaust port on the muffler plate is centered between the two exhaust ports on the center section.
- Stainless bolts should be lubed to reduce the possibility of seizing during tightening.

| Maximum Torque Specifications | |
|-------------------------------|---------------------|
| Description | Torque |
| Pro-Flo® Air Valve Bolts | 5.1 N•m (45 in-lb) |
| Air Chamber to Center Block | 27.1 N•m (20 ft-lb) |
| Outer Pistons | 47.5 N•m (35 ft-lb) |
| Manifolds to Liquid Chamber | 9.6 N•m (85 in-lb) |
| Liquid Chamber to Air Chamber | 9.6 N•m (85 in-lb) |

DISASSEMBLY / REASSEMBLY

SHAFT SEAL INSTALLATION

Pre-Installation

After all the old seals have been removed, the inside of the bushing should be cleaned to ensure no debris is left that may cause premature damage to the new seals.

Installation

1. To prevent damaging the inside surface of the new seal, wrap electrical tape around each leg of the needle-nose pliers. (Heat shrink tubing may also be used.)
2. With a new seal in hand, place the two legs of the needle-nose pliers inside the seal ring. (See Figure A.)
3. Open the pliers as wide as the seal diameter will allow, then with two fingers pull down on the top portion of the seal to form a kidney bean shape. (See Figure B.)
4. Lightly clamp the pliers together to hold the seal into the kidney shape. Be sure to pull the seal into as tight of a kidney shape as possible. This will allow the seal to travel down the bushing bore with greater ease.
5. With the seal clamped in the pliers, insert the seal into the bushing bore and position the bottom of the seal into the correct groove. When the bottom of the seal is seated in the groove, release the clamp pressure on the pliers. This will allow the seal to partially snap back to its original shape.
6. After removing the pliers, you will notice a slight bump in the seal shape. Before the seal can be resized properly, the bump in the seal should be removed as much as possible. This can be done with either a Phillips screwdriver or your finger. With the side of the screwdriver or your finger, apply light pressure to the peak of the bump. This pressure will cause the bump to be eliminated almost completely.
7. Lubricate the edge of the shaft with NLGI grade 2 white EP bearing grease.
8. Slowly insert the center shaft with a rotating motion. This will complete the resizing of the seal.
9. Repeat these steps for the remaining seals.

Tools

The following tools can be used to aid in the installation of the new seals:

- Needle-Nose Pliers
- Phillips Screwdriver
- Electrical Tape

Figure A

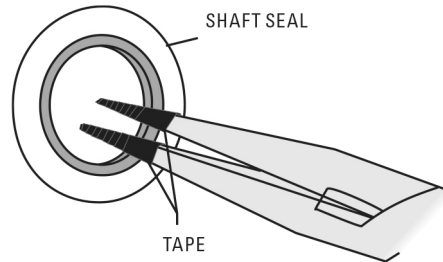
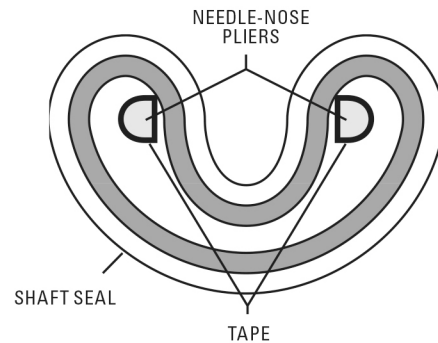

Figure B



SECTION 8

EXPLODED VIEW AND PARTS LIST

P400 PLASTIC

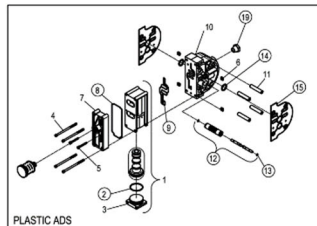
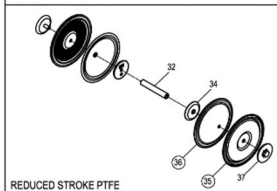
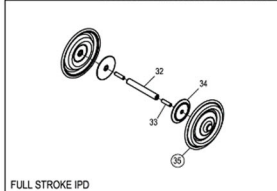
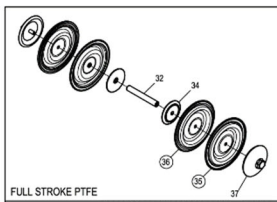
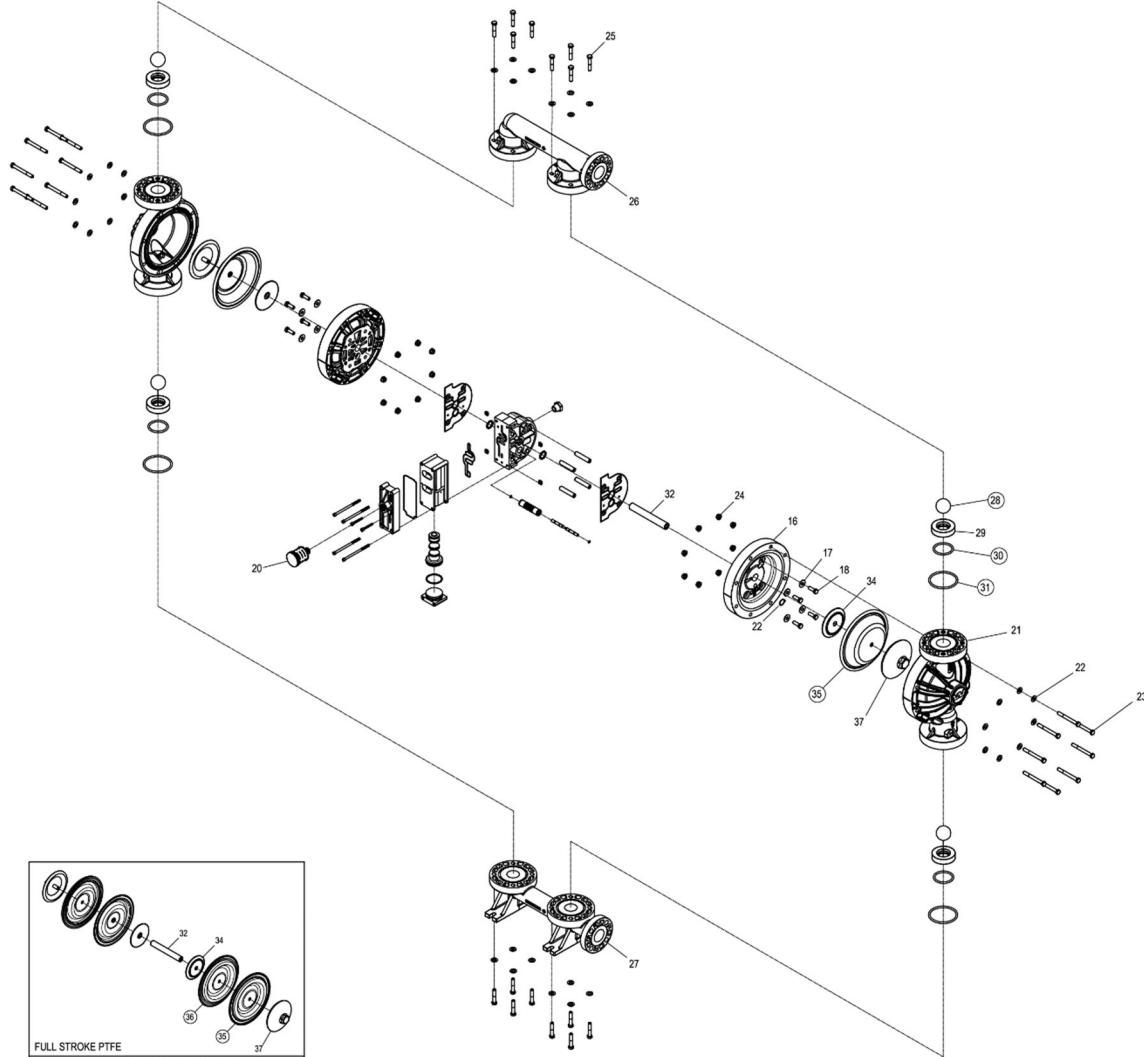

ALL CIRCLED PART IDENTIFIERS ARE INCLUDED IN REPAIR KITS

LW0328 REV. B

EXPLODED VIEW AND PARTS LIST

| Item | Description | Qty. | Model Description | |
|--|---|------|-------------------|----------------|
| | | | P400/PPPPP | P400/KKPPP |
| | | | P/N | P/N |
| Air Distribution Components | | | | |
| 1 | Air Valve Assembly, Pro-Flo ¹ | 1 | 04-2000-20-700 | |
| 2 | O-Ring, End Cap (-225, Ø1.859" x Ø.139") | 2 | 04-2390-52-700 | |
| 3 | End Cap | 2 | 04-2330-20-700 | |
| 4 | Screw, SHC, Air Valve (1/4"-20 x 4-1/2") | 4 | 01-6000-03 | |
| 5 | Screw, SHC, Air Valve (#10-16 x 1-3/4") | 2 | 04-6351-03 | |
| 6 | Nut, Square (1/4"-20) | 4 | 00-6505-03 | |
| 7 | Muffler Plate, Pro-Flo® | 1 | 04-3180-20-700 | |
| 8 | Gasket, Muffler Plate, Pro-Flo ® | 1 | 04-3500-52-700 | |
| 9 | Gasket, Air Valve, Pro-Flo ® | 1 | 04-2600-52-700 | |
| 10 | Center Block Assembly, Pro-Flo ² | 1 | 04-3110-20 | |
| 11 | Sleeve, Threaded, Center Block | 4 | 04-7710-08 | |
| 12 | Removable Pilot Sleeve Assembly | 1 | 04-3882-99 | |
| 13 | Pilot Spool Retaining O-Ring (-009, Ø.204" x Ø.070") | 2 | 04-2650-49-700 | |
| 14 | Shaft Seal | 2 | 08-3210-55-225 | |
| 15 | Gasket, Center Block Pro-Flo ® | 2 | 04-3526-56 | |
| 16 | Air Chamber, Pro-Flo® | 2 | 04-3681-20 | |
| 17 | Washer, Flat (Ø.406" x Ø.875" x .125") | 8 | 04-6741-03 | |
| 18 | Screw, HHC (3/8"-16 x 1-1/4") | 8 | 04-6190-03 | |
| 19 | Bushing Reducer 3/4" MNPT to 1/2" FNPT | 1 | 04-6950-20-700 | |
| 20 | Muffler 3/4" MNPT | 1 | 04-3510-99 | |
| Wetted Path Components | | | | |
| 21 | Chamber, Liquid | 2 | 04-5005-20 | 04-5005-21 |
| 22 | Washer, Plain (Ø.406" x Ø.812" x .065") | 32 | 04-6740-03 | |
| 23 | Screw, HHCS (3/8"-16 x 3-1/2") | 16 | 04-6191-03 | |
| 24 | Nut, Hex Flange (3/8"-16) | 16 | 04-6435-03 | |
| 25 | Screw, HHCS, (3/8"-16 x 1-3/4") | 16 | 04-6181-03 | |
| 26 | Manifold, Discharge (ANSI) | 1 | 04-5030-20 | 04-5030-21 |
| | Manifold, Discharge (DIN) | 1 | 04-5031-20 | 04-5031-21 |
| 27 | Manifold, Inlet (ANSI) | 1 | 04-5090-20 | 04-5090-21 |
| | Manifold, Inlet (DIN) | 1 | 04-5091-20 | 04-5091-21 |
| Gaskets/Valve Balls/Valve Seats/Valve O-Rings | | | | |
| 28 | Valve Ball | 4 | | * |
| 29 | Valve Seat | 4 | 04-1125-20 | 04-1125-21 |
| 30 | Valve Seat O-Ring (-331, Ø2.225" x Ø.210") | 4 | | * |
| 31 | Manifold O-Ring (-340, Ø3.350" x Ø.210") | 4 | | * |
| Full Stroke Rubber/TPE/PTFE/FSIPD Components | | | | |
| 32 | Shaft, Pro-Flo® Rubber Advanced | 1 | 04-3811-03 | |
| 33 | Shaft Stud (1/2"-20 x 1-7/8") | 2 | 08-6150-08 | |
| 34 | Piston, Inner, Full Stroke Rubber/TPE/PTFE/FSIPD | 2 | 04-3700-01-700 | |
| 35 | Diaphragm, Primary | 2 | | * |
| | Diaphragm, Primary, Full Stroke PTFE | 2 | | * |
| | Diaphragm, IPD Primary | 2 | | * |
| 36 | Diaphragm, Back-Up, Full Stroke PTFE | 2 | | * |
| 37 | Piston, Outer, Full Stroke Rubber/TPE/PTFE | 2 | 04-4550-20-500 | 04-4550-21-500 |
| Reduced Stroke PTFE Components | | | | |
| 32 | Shaft, Pro-Flo® | 1 | 04-3842-03 | |
| 34 | Piston, Inner, Reduced Stroke PTFE | 2 | 04-3752-01 | |
| 35 | Diaphragm, Primary, Reduced Stroke PTFE | 2 | | * |
| 36 | Diaphragm, Back-Up, Reduced Stroke PTFE | 2 | | * |
| 37 | Piston, Outer, Reduced Stroke PTFE | 2 | 04-4600-20-500 | 04-4600-21-500 |

LW0329 REV. C

* See elastomer chart - Section 9

¹ Air Valve Assembly includes items 2 and 3.

² Center Block Assembly includes item 10 and 14.

BSPT to NPT Air Line Reducer Bushing (P/N 04-6950-23-702) is available upon request.

0502 Specialty Code = PFA-Coated Hardware

0504 Specialty Code = DIN Flange

All boldface items are primary wear parts.

LW0329 REV. B

SECTION 9

ELASTOMER OPTIONS

P400 PLASTIC

| MATERIALS | DIAPHRAGMS (2) | FULL-STROKE DIAPHRAGMS (2) | FULL-STROKE BACKUP DIAPHRAGMS (2) | EZ-INSTSALL DIAPHRAGMS (2) | FULL-STROKE IPD DIAPHRAGMS (2) | REDUCED STROKE DIAPHRAGMS (2) | REDUCED STROKE BACK-UP DIAPHRAGMS (2) | VALVE BALLS (4) | VALVE SEATS (4) | VALVE SEAT O-RING (4) | MANIFOLD O-RING (4) |
|--------------------------|----------------|----------------------------|-----------------------------------|----------------------------|--------------------------------|-------------------------------|---------------------------------------|-----------------|-----------------|-----------------------|---------------------|
| Polyurethane | | | | 04-1022-50 | | | | 04-1080-50 | | | |
| Neoprene | 04-1010-51 | | | | | | 04-1060-51 | 04-1080-51 | | | |
| Buna-N | 04-1010-52 | | | | | | | 04-1080-52 | | 08-1300-52-500 | 04-1371-52 |
| Geolast | | | | 04-1022-15 | | | | | | | |
| EPDM | 04-1010-54 | | | | | | 04-1060-54 | 04-1080-54 | | | |
| FKM | 04-1010-53 | | | | | | | 04-1080-53 | | | |
| Non-Food Grade Saniflex™ | | | | | 04-1031-46 | | | | | | |
| Saniflex™ | 04-1010-56 | | 04-1065-56 | 04-1022-56 | | | 04-1060-56 | 04-1080-56 | | | |
| PTFE | | 04-1040-55 | | | | 04-1010-55 | | 04-1080-55 | | | |
| PTFE Encap. FKM | | | | | | | | | | 08-1300-60-500 | 04-1371-60 |
| FDA Wil-Flex™ | 04-1010-57 | | 04-1065-57 | 04-1022-57 | 04-1031-57 | | | 04-1080-57 | | | |
| Wil-Flex™ | 04-1010-58 | | | 04-1022-58 | 04-1031-58 | | | 04-1080-58 | | 08-1300-58-500 | 04-1371-58 |
| Polypropylene | | | | | | | | | 04-1125-20 | | |
| PVDF | | | | | | | | | 04-1125-21 | | |

Back-up diaphragms used with PTFE diaphragms only.

LW0329 REV. C

WILDEN®

PSG
22069 Van Buren Street
Grand Terrace, CA 92313-5651 USA
P: +1 (909) 422 -1730
psgdover.com



Where Innovation Flows

Copyright 2021 PSG®, a Dover® Company
PSG® reserves the right to modify the information and illustrations contained in this document without prior notice. This is a non-contractual document.